



US00D865701S

(12) **United States Design Patent**
Tani

(10) **Patent No.:** **US D865,701 S**

(45) **Date of Patent:** **** Nov. 5, 2019**

(54) **TELEPHONE BASE UNIT**

(71) Applicant: **Panasonic Intellectual Property Management Co., Ltd.**, Osaka-shi, Osaka (JP)

(72) Inventor: **Atsushi Tani**, Kyoto (JP)

(73) Assignee: **Panasonic Intellectual Property Management Co., Ltd.**, Osaka (JP)

(**) Term: **15 Years**

(21) Appl. No.: **29/654,173**

(22) Filed: **Jun. 21, 2018**

(51) **LOC (12) Cl.** **14-03**

(52) **U.S. Cl.**
USPC **D14/151**

(58) **Field of Classification Search**
USPC ... D14/140, 140.1, 140.7, 140.8, 141.2, 142, D14/144, 147, 148, 149, 150, 151, 158, D14/159, 188, 217, 240, 243, 247, 248, D14/251, 299, 329, 462, 467, 471, 130, D14/403, 338; D21/517; D24/165
CPC H04M 1/00; H04M 1/003; H04M 1/02; H04M 1/0289; H04M 1/0297; H04M 1/0214; H04M 1/03; H04M 1/23; H04M 1/253; H04M 1/2535; H04M 7/006
See application file for complete search history.

(56) **References Cited**

U.S. PATENT DOCUMENTS

D291,565 S *	8/1987	Okuda	H04M 1/02	D14/151
D299,456 S *	1/1989	Kuo		D14/151
D349,899 S *	8/1994	Siddoway		D13/108
D363,285 S *	10/1995	Vessey		D14/151
D401,235 S *	11/1998	Fuke		D14/149
D405,447 S *	2/1999	Landry		D14/151
D412,171 S *	7/1999	Girardi		D14/151

D472,227 S *	3/2003	Takayama	D14/151
D490,795 S *	6/2004	Watanabe	D14/151
D499,078 S *	11/2004	Abe	D14/151
D499,079 S *	11/2004	Abe	D14/151
D500,995 S *	1/2005	Kolwaite	D14/147
D514,544 S *	2/2006	Beasley	D13/108
D529,477 S *	10/2006	Hsu	D14/151
D529,894 S *	10/2006	Yanagisawa	D14/151
D530,303 S *	10/2006	Tang	D14/151
D531,979 S *	11/2006	Pettit	D14/151
D555,143 S *	11/2007	Chou	D14/151
D555,630 S *	11/2007	Udagawa	D14/149
D556,180 S *	11/2007	Udagawa	D14/149
D556,181 S *	11/2007	Liu	D14/151
D571,777 S *	6/2008	Waterman	D14/151
D576,998 S *	9/2008	Furuno	D14/151
D581,897 S *	12/2008	Katori	D14/151
D588,573 S *	3/2009	West	D14/151
D608,759 S *	1/2010	Chun	D14/151

(Continued)

Primary Examiner — Marie D. Fast Horse

(74) *Attorney, Agent, or Firm* — Brinks Gilson & Lione

(57) **CLAIM**

I claim the ornamental design for a telephone base unit, as shown and described.

DESCRIPTION

FIG. 1 is a front and top perspective view of a telephone base unit of the present invention;
FIG. 2 is a rear and top perspective view thereof;
FIG. 3 is a front view thereof;
FIG. 4 is a rear view thereof;
FIG. 5 is a first side view thereof;
FIG. 6 is a second side view thereof;
FIG. 7 is a top view thereof; and,
FIG. 8 is a bottom view thereof.
The broken lines show parts of the telephone base unit that represent unclaimed subject matter and form no part of the claimed design.

1 Claim, 8 Drawing Sheets

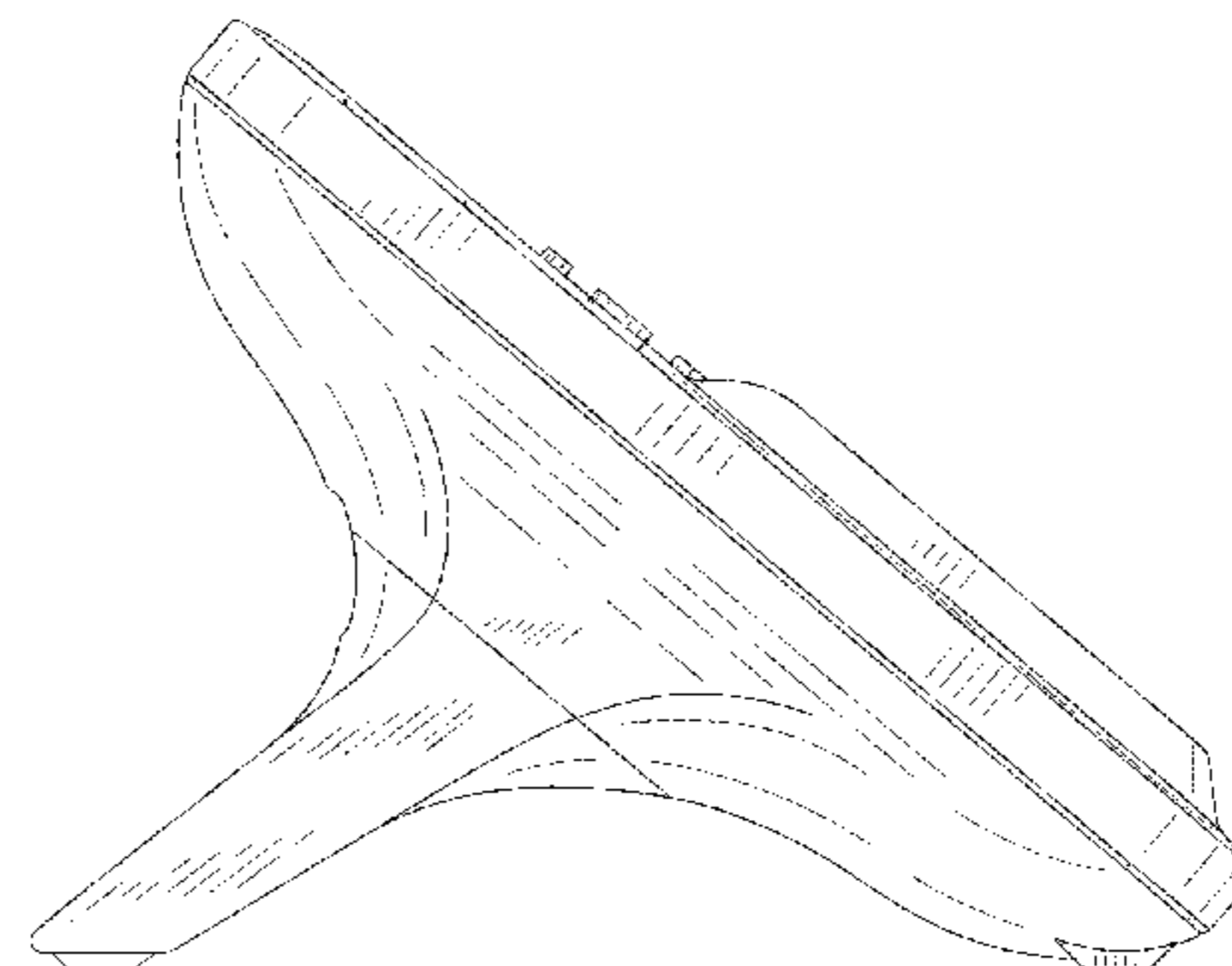
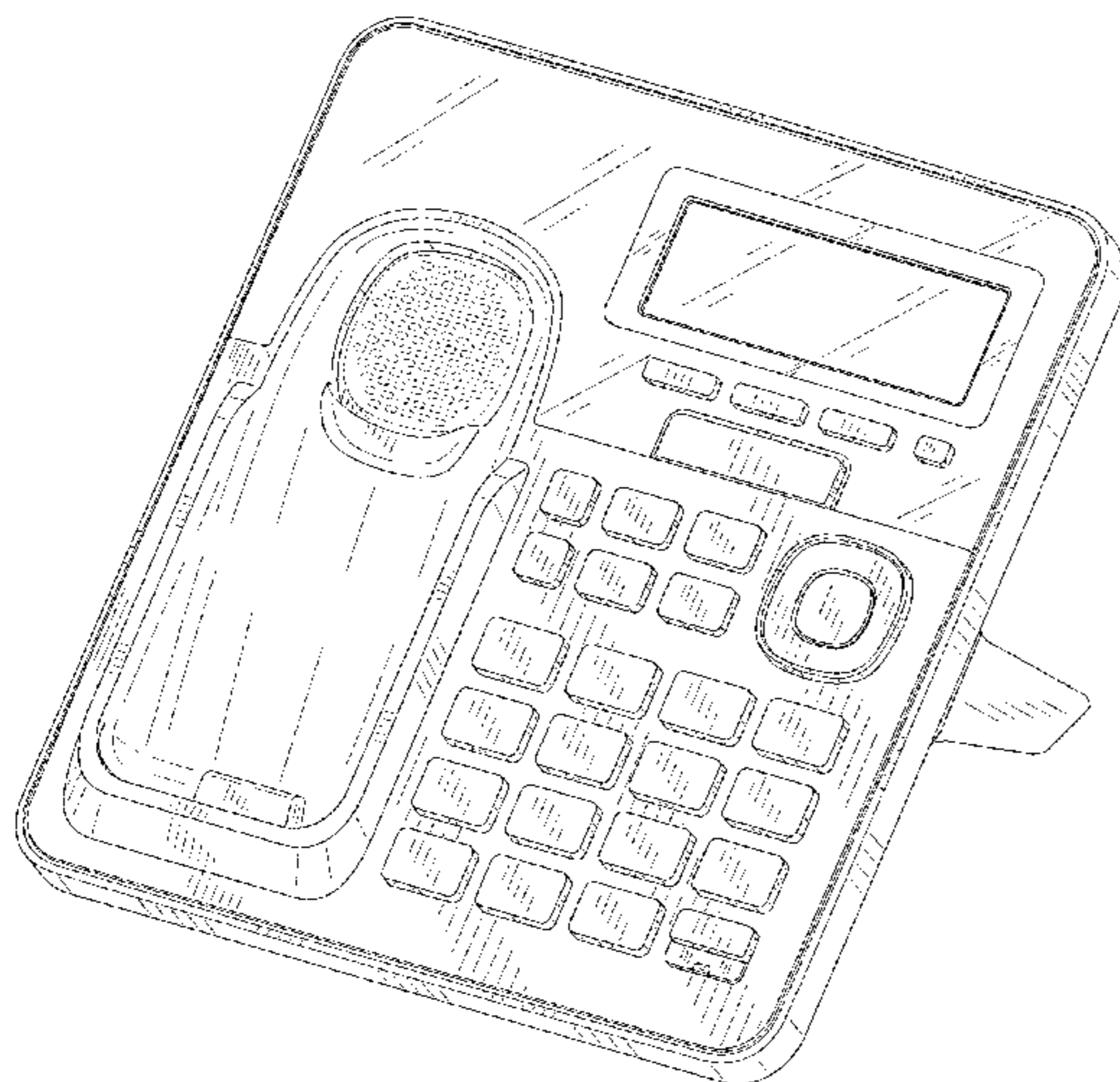

(56)

References Cited

U.S. PATENT DOCUMENTS

D609,212	S	*	2/2010	Turnbull	D14/151
D611,031	S	*	3/2010	Lesniak	D14/151
D613,724	S	*	4/2010	Kao	D14/151
D617,301	S	*	6/2010	Furuno	D14/149
D657,771	S	*	4/2012	Sakamoto	D14/150
D657,772	S	*	4/2012	Shadovitz	D14/150
D657,773	S	*	4/2012	Corsini	D14/151
D664,520	S	*	7/2012	Shadovitz	D14/150
D671,518	S	*	11/2012	Ookawa	D14/149
D678,238	S	*	3/2013	Furuno	D14/150
D678,855	S	*	3/2013	Shadovitz	D14/150
D709,852	S		7/2014	Yoshida		
D714,251	S	*	9/2014	Ookawa	D14/149
D750,591	S		3/2016	Katori		
D753,624	S	*	4/2016	Ji	D14/151
D767,527	S	*	9/2016	Hillenmayer	D14/140.8
D771,005	S		11/2016	Tani et al.		
D781,809	S	*	3/2017	Schwarz	D14/151
D782,994	S	*	4/2017	Schwarz	D14/151
D783,569	S	*	4/2017	Kwak	D14/151
D788,737	S	*	6/2017	Takei	D14/151
D789,322	S	*	6/2017	Ookawa	D14/150
D829,189	S	*	9/2018	Su	D14/151
D835,599	S	*	12/2018	Peng	D14/151
D843,965	S	*	3/2019	Su	D14/151
D845,265	S	*	4/2019	Tani	D14/150
D848,391	S	*	5/2019	Li	D14/151
D853,981	S	*	7/2019	Nakano	D14/151
2012/0219147	A1	*	8/2012	Suzuki	H04M 1/0297 379/435

* cited by examiner

FIG. 1



FIG. 2

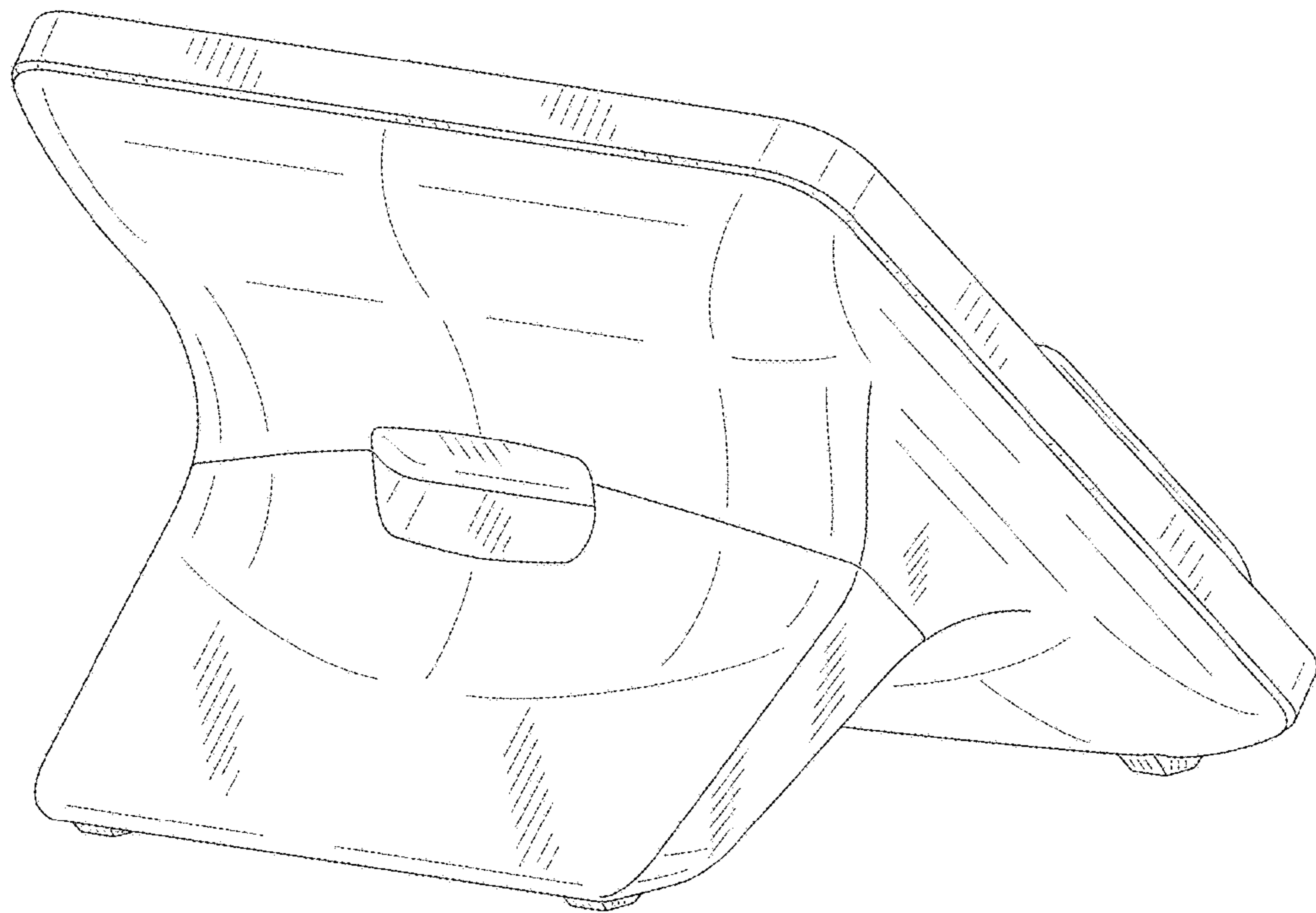

FIG. 3

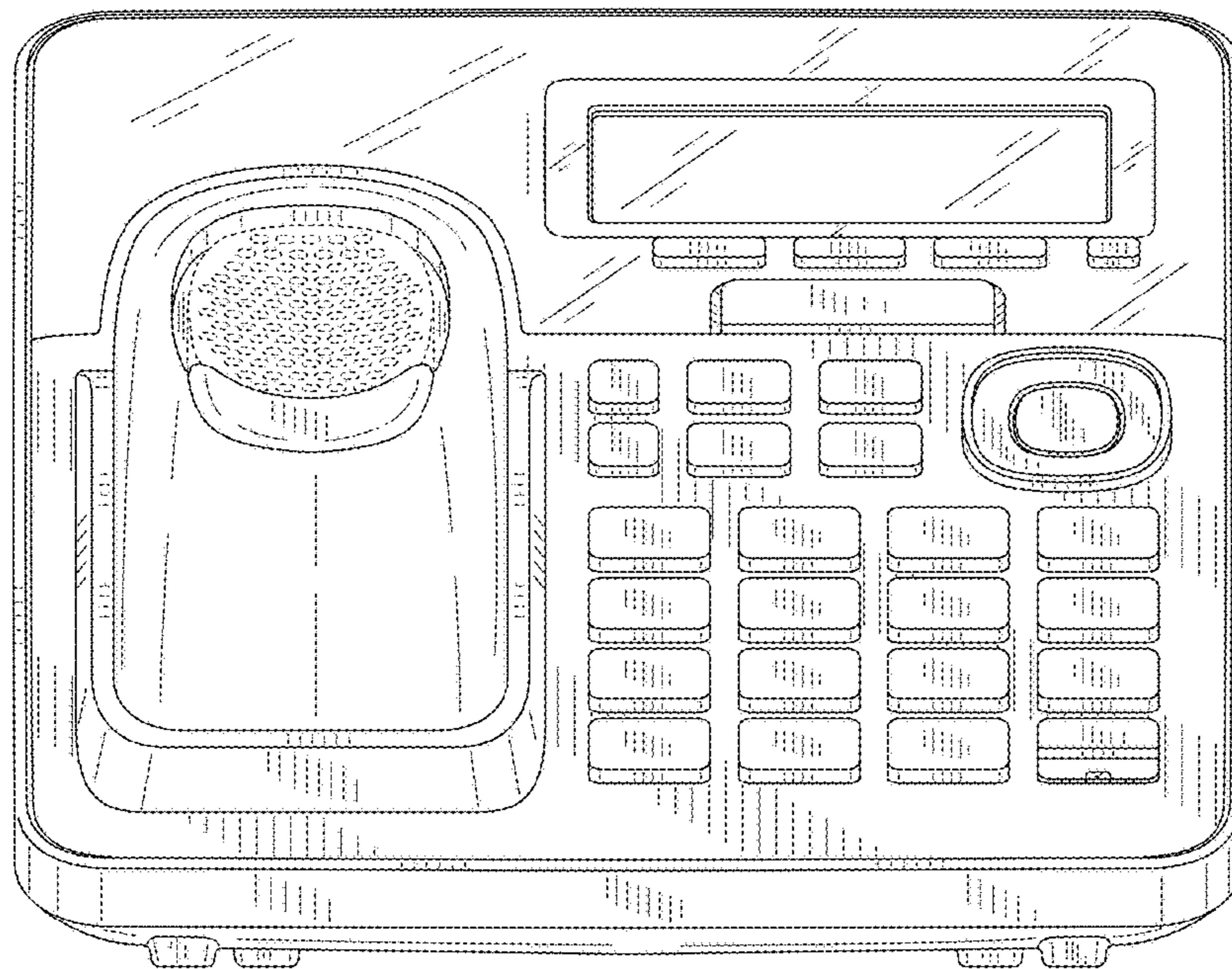

FIG. 4

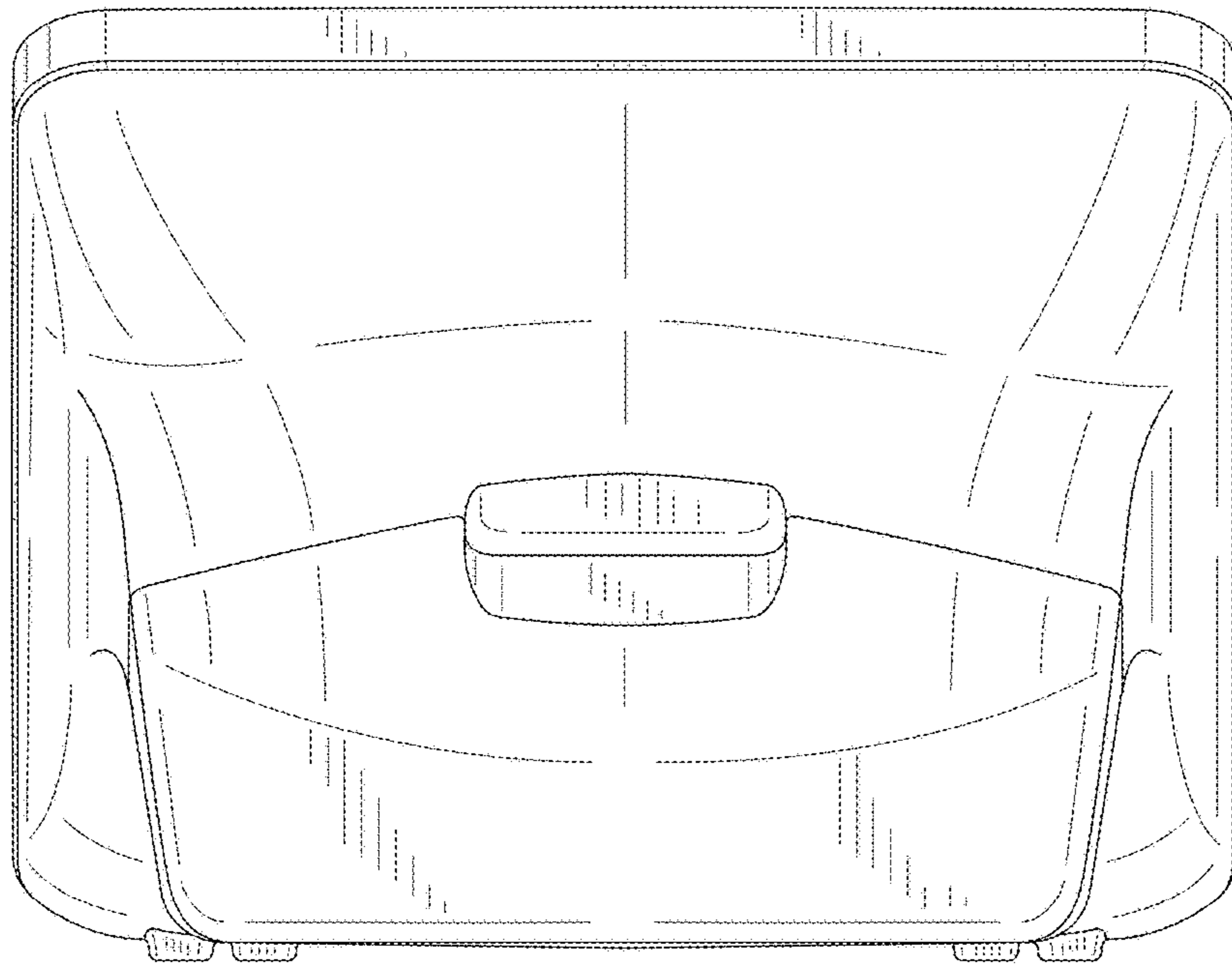

FIG. 5

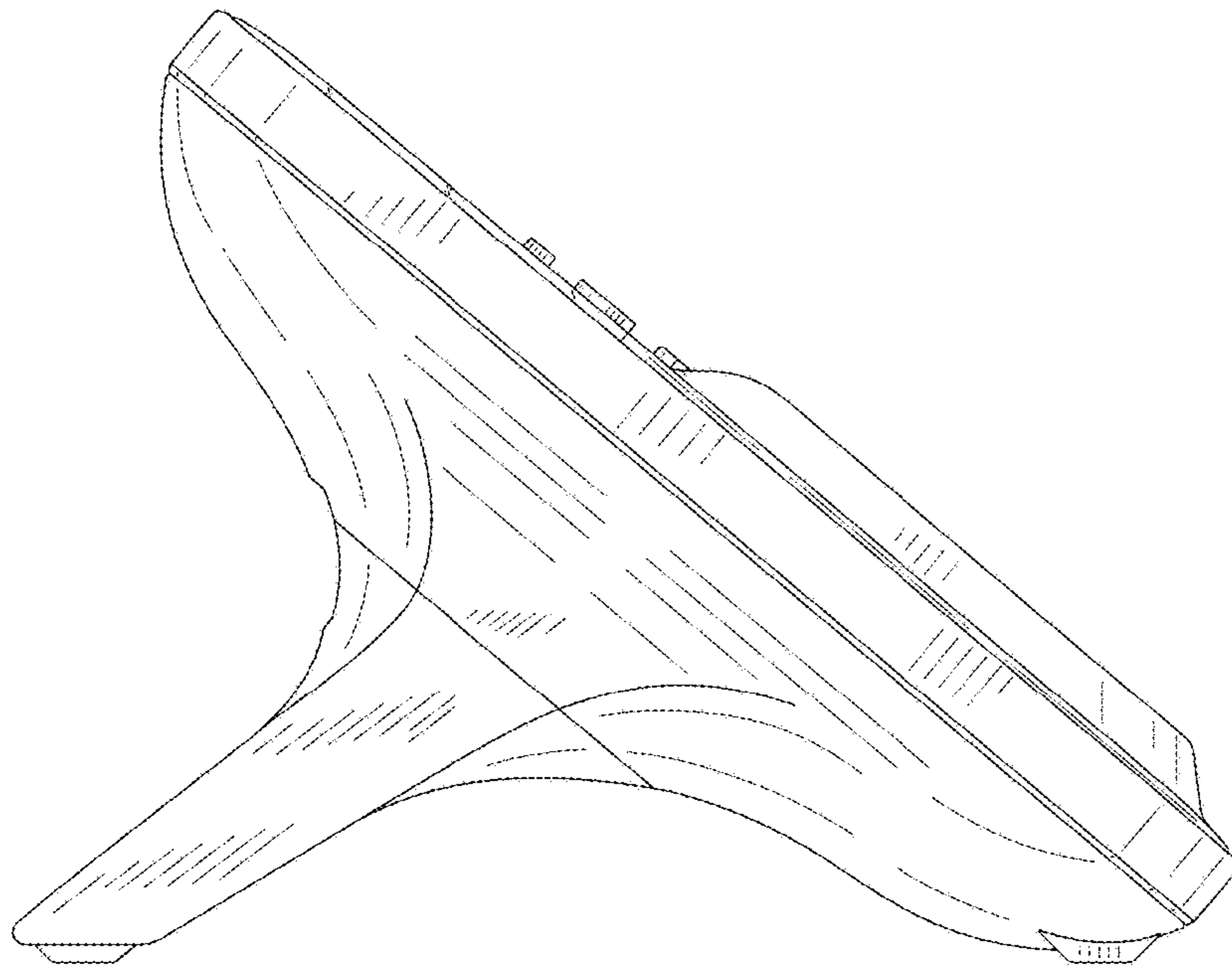

FIG. 6

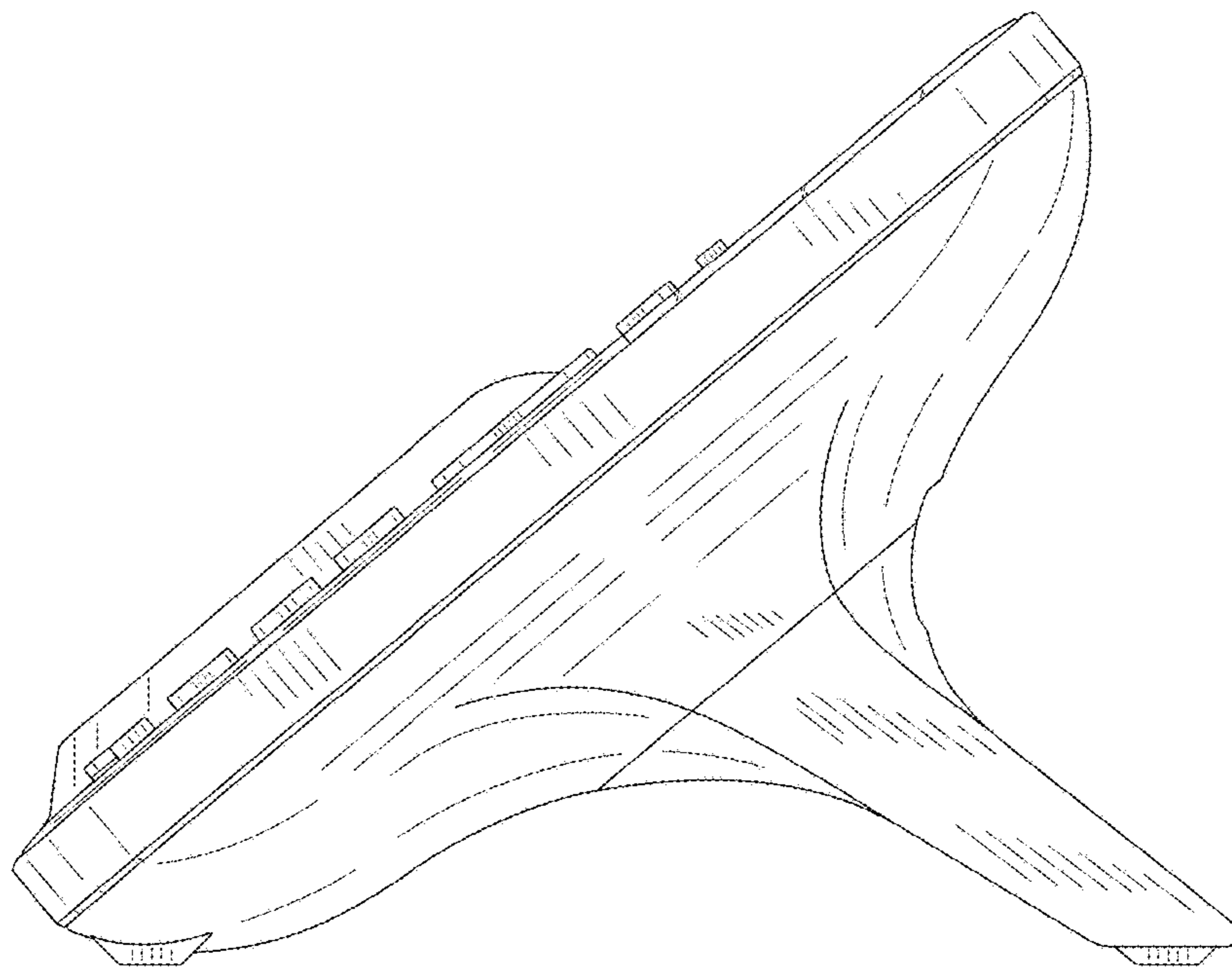

FIG. 7



FIG. 8

