



US00D865591S

(12) **United States Design Patent** (10) **Patent No.:** **US D865,591 S**
Smock et al. (45) **Date of Patent:** **** Nov. 5, 2019**

(54) **VEHICLE HOOD**

(57) **CLAIM**

(71) Applicant: **HONDA MOTOR CO., LTD.**,
Minato-ku, Tokyo (JP)
(72) Inventors: **Randall Smock**, Redondo Beach, CA
(US); **Matthew P. Mantz**, Lake Forest,
CA (US)

The ornamental design for a vehicle hood, as shown and described.

(73) Assignee: **HONDA MOTOR CO., LTD**, Tokyo
(JP)

DESCRIPTION

(**) Term: **15 Years**

FIG. 1 is a top, rear and left side perspective view of a vehicle hood showing our new design;
FIG. 2 is a top, rear and left side perspective view thereof;
FIG. 3 is a top, front and right side perspective view thereof;
FIG. 4 is a top, front and left side perspective view thereof;
FIG. 5 is a rear elevational view thereof;
FIG. 6 is a front elevational view thereof;
FIG. 7 is a right side elevational view thereof;
FIG. 8 is a left side elevational view thereof;
FIG. 9 is a top plan view thereof;
FIG. 10 is a bottom plan view thereof;
FIG. 11 is a top, rear and left side perspective view of a vehicle hood showing a second embodiment of our new design;
FIG. 12 is a top, rear and right side perspective view of FIG. 11;
FIG. 13 is a top, front and right side perspective view of FIG. 11;
FIG. 14 is a top, front and left side perspective view of FIG. 11;
FIG. 15 is a rear elevational view of FIG. 11;
FIG. 16 is a front elevational view of FIG. 11;
FIG. 17 is a right side elevational view of FIG. 11;
FIG. 18 is a left side elevational view of FIG. 11;
FIG. 19 is a top plan view of FIG. 11; and,
FIG. 20 is a bottom plan view of FIG. 11
The broken lines shown in the figures are included for the purpose of illustrating portions of the vehicle hood and form no part of the claimed design.

(21) Appl. No.: **29/633,304**

(22) Filed: **Jan. 12, 2018**

(51) **LOC (12) Cl.** **D12-16**

(52) **U.S. Cl.**
USPC **D12/173**

(58) **Field of Classification Search**
USPC D12/173, 196, 86, 90-92, 181;
180/69.21, 69.2, 69.22; 296/190.1-190.5,
296/190.8, 193.11, 37.6
CPC B62D 25/10; B62D 25/06; B62D 65/02;
B62D 25/12; B60Q 1/00
See application file for complete search history.

(56) **References Cited**

U.S. PATENT DOCUMENTS

D813,759 S *	3/2018	Perkins	D12/173
D818,904 S *	5/2018	Jeong	D12/173
D818,907 S *	5/2018	Whitla	D12/173
D841,540 S *	2/2019	Koo	D12/173
D844,512 S *	4/2019	Wheel	D12/173

* cited by examiner

Primary Examiner — Melody N Brown

(74) *Attorney, Agent, or Firm* — Arent Fox LLP

1 Claim, 20 Drawing Sheets

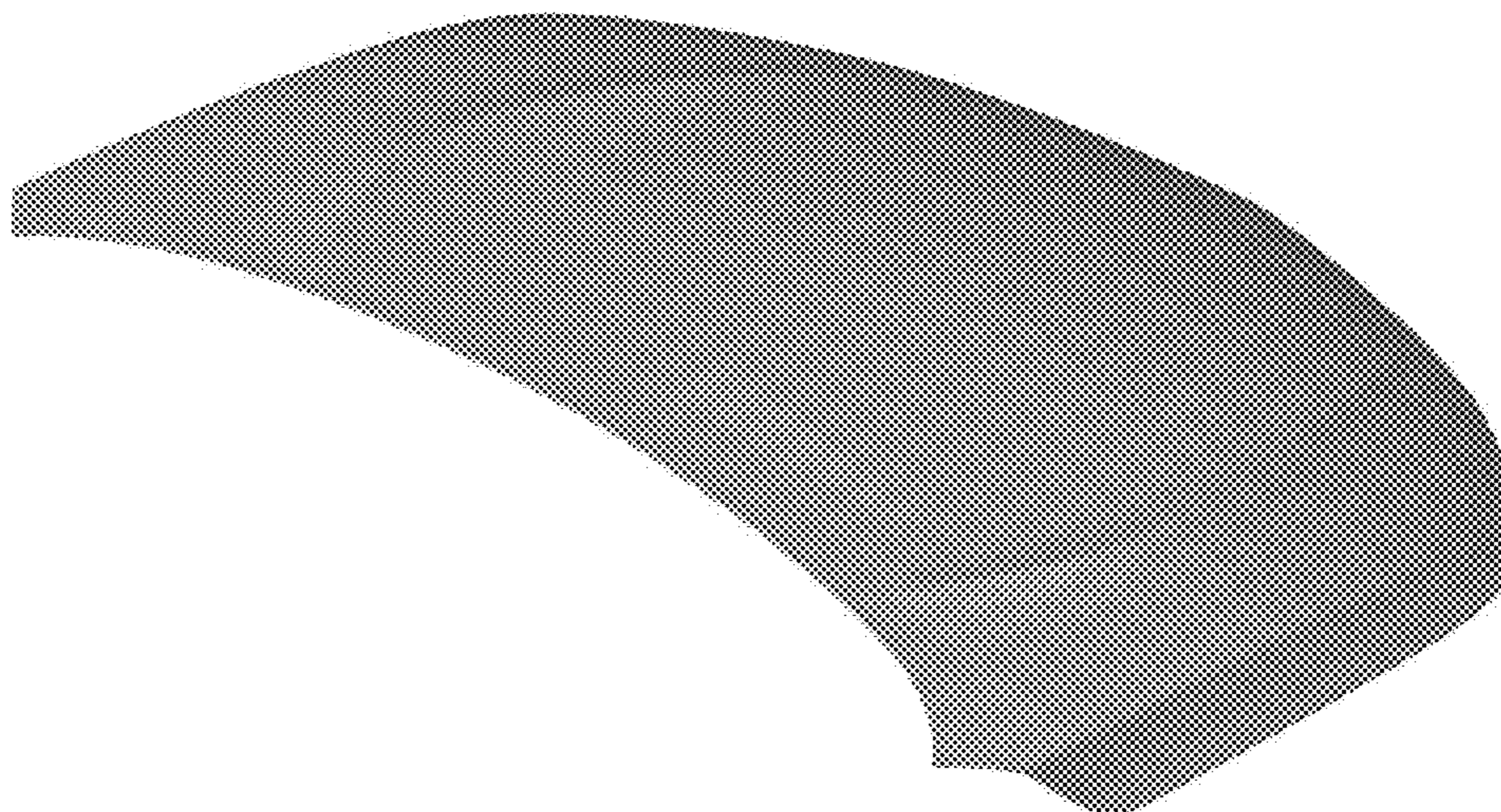

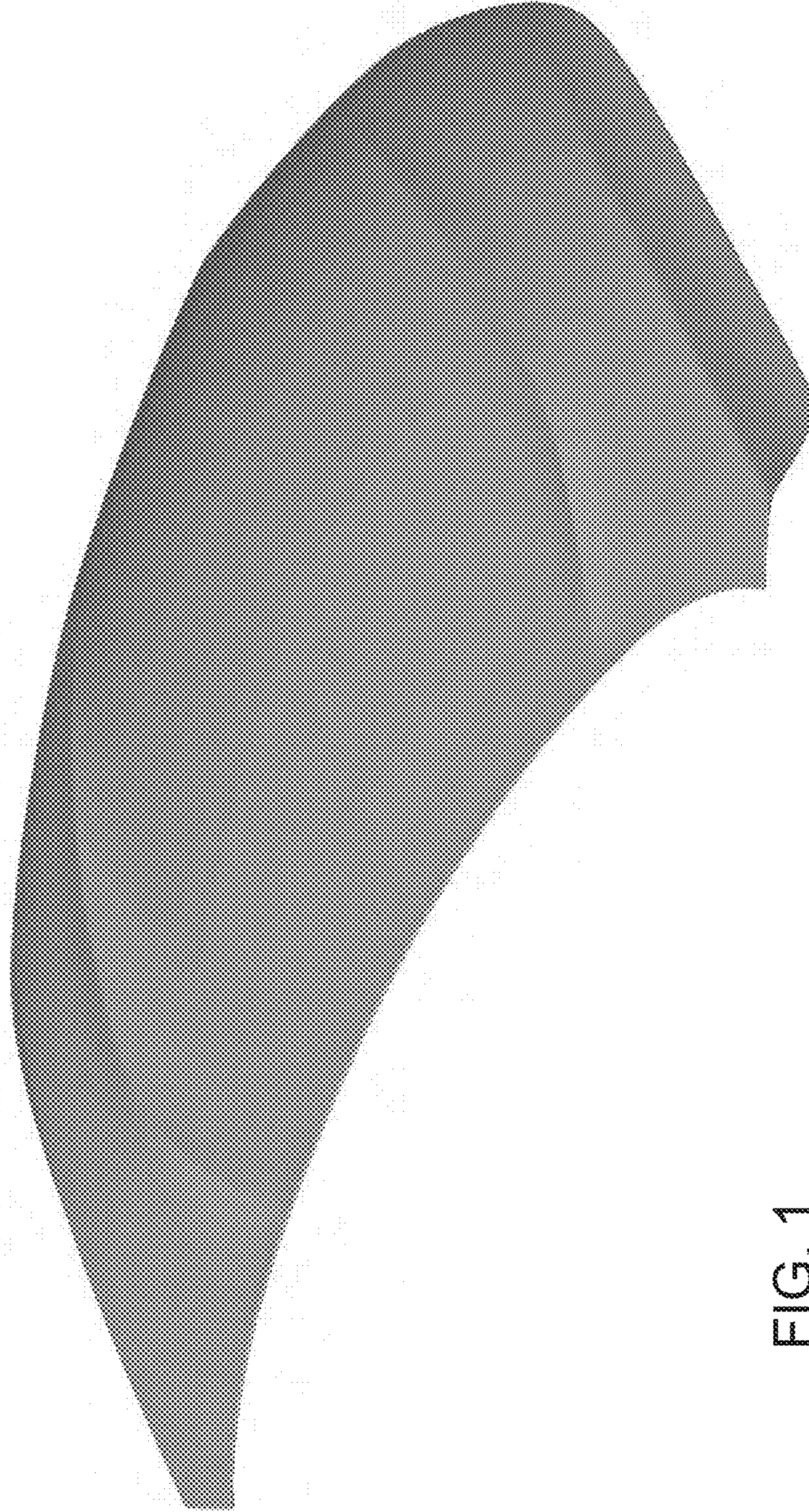

FIG. 1

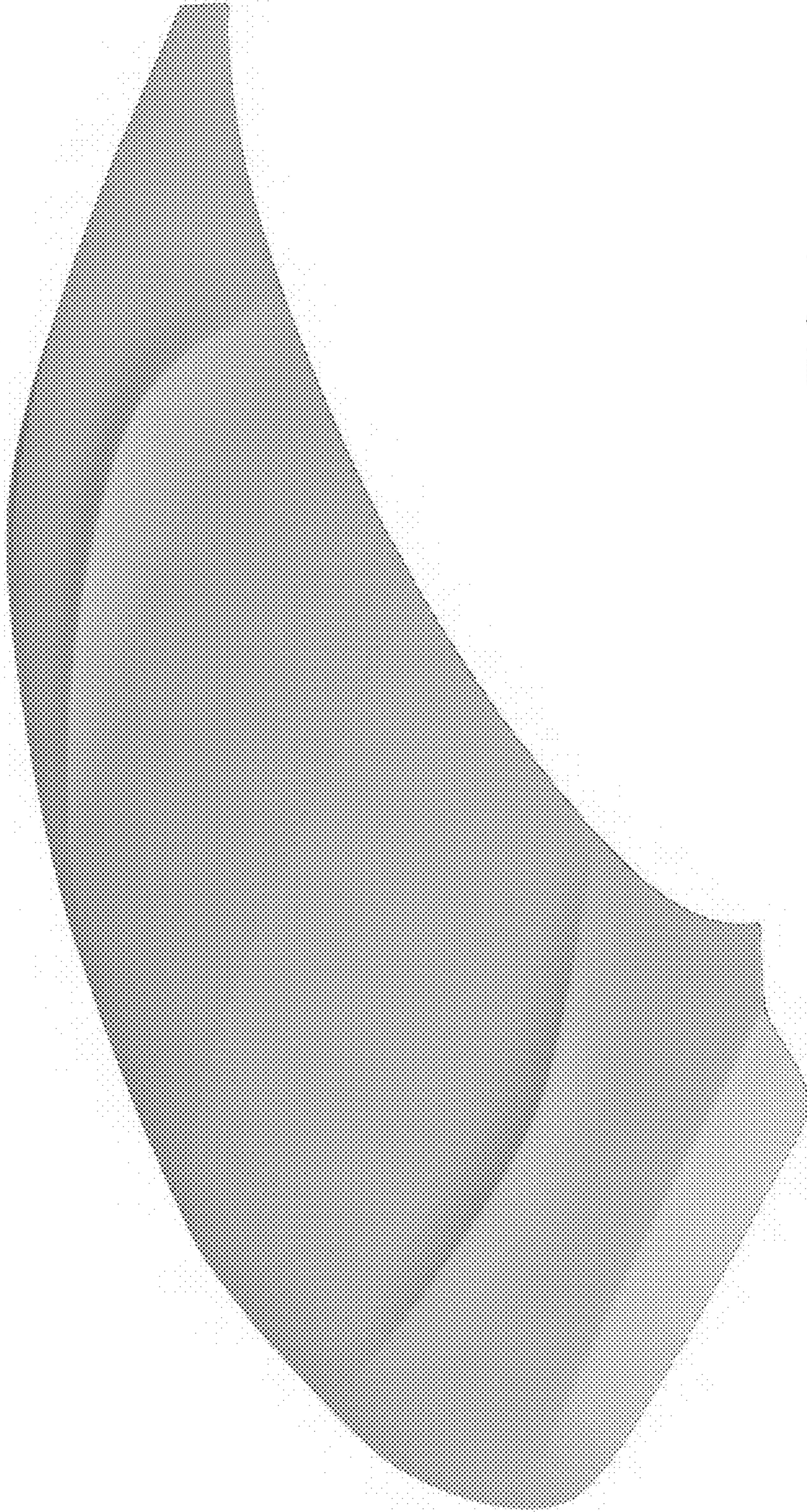

FIG. 2

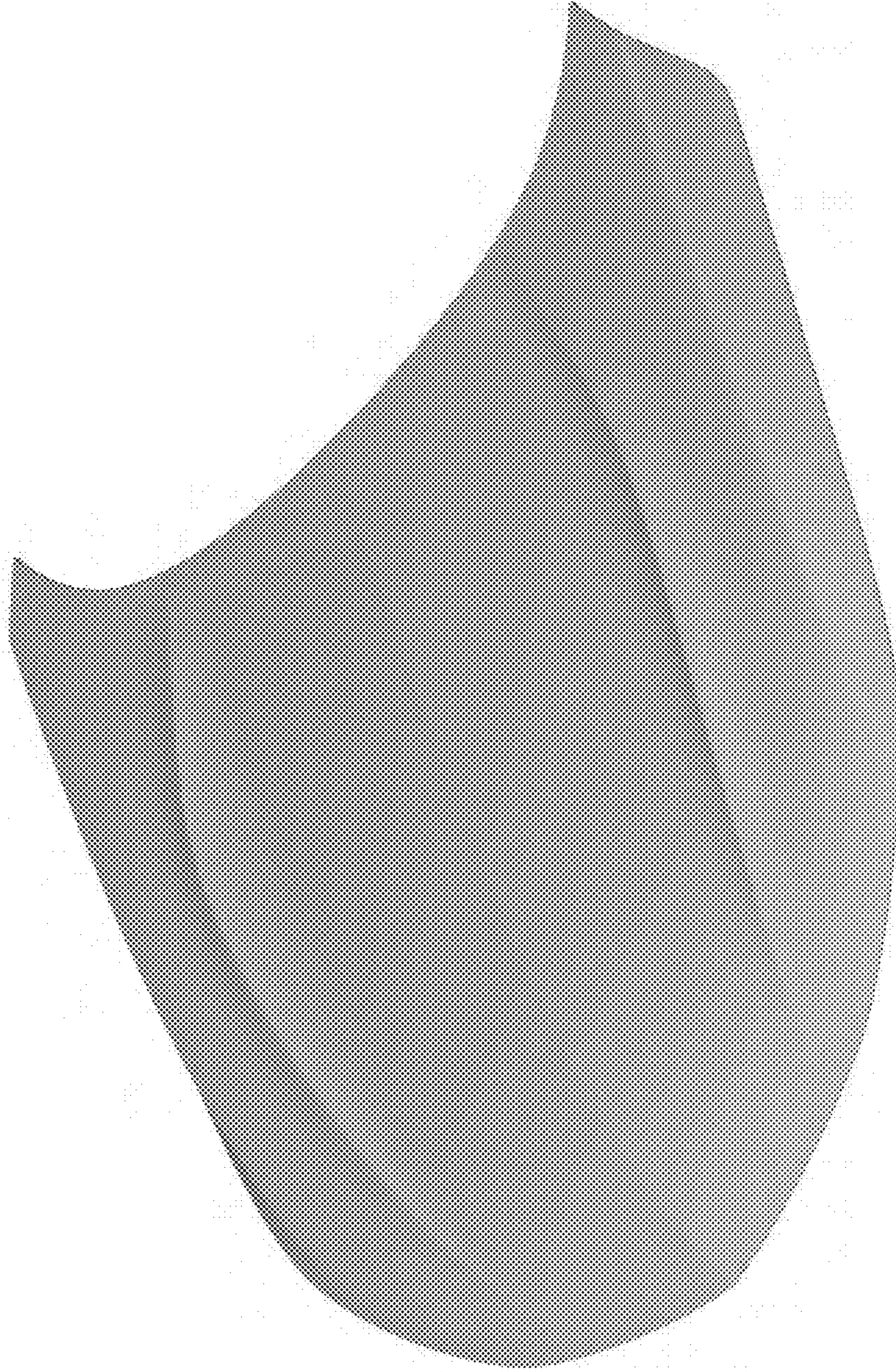

FIG. 3



FIG. 4

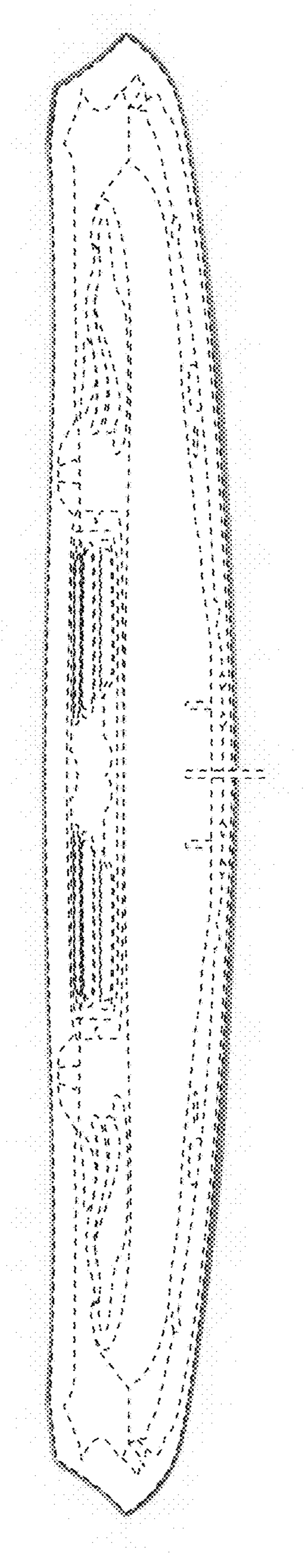

FIG. 5

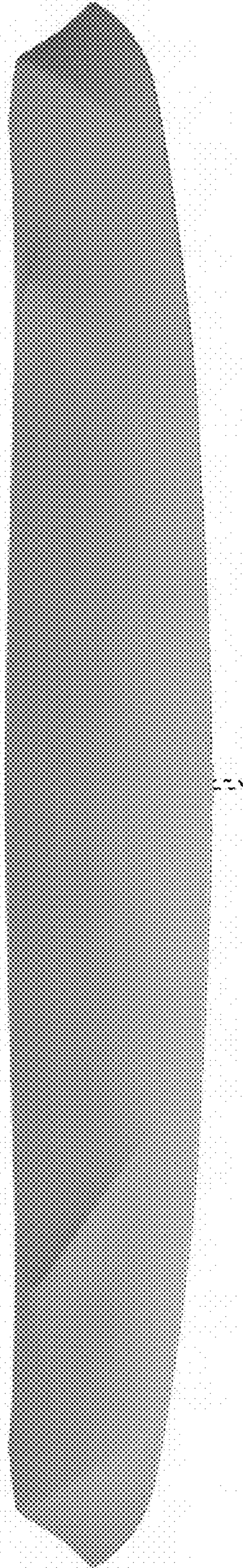

FIG. 6

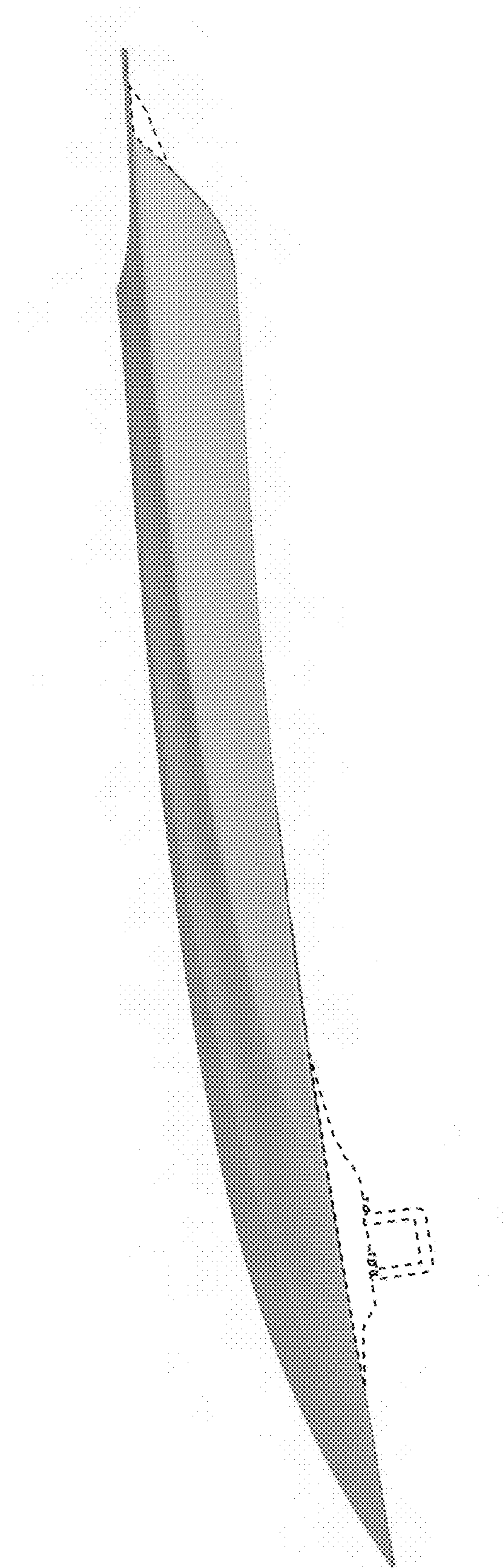

FIG. 7

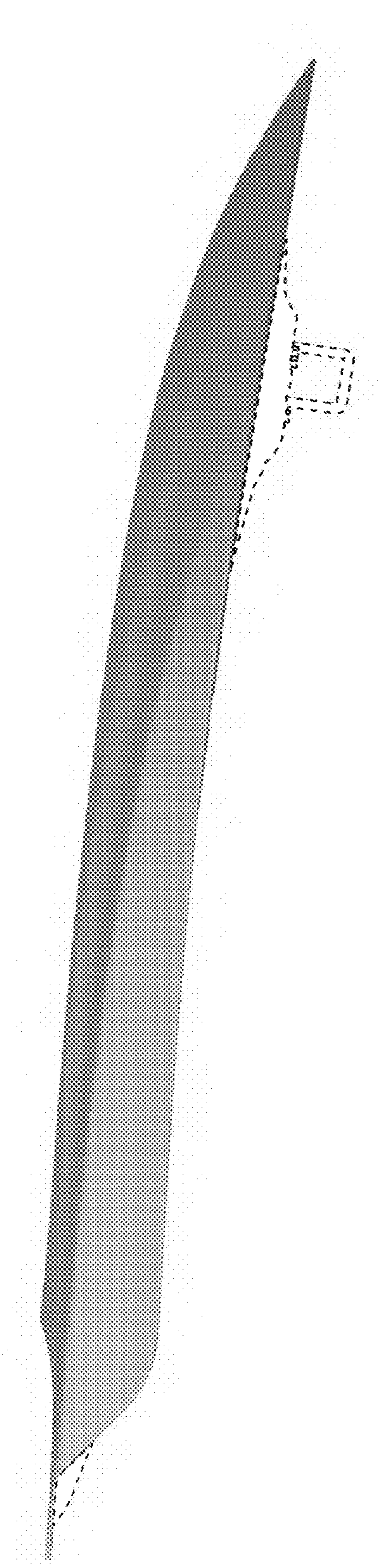

FIG. 8

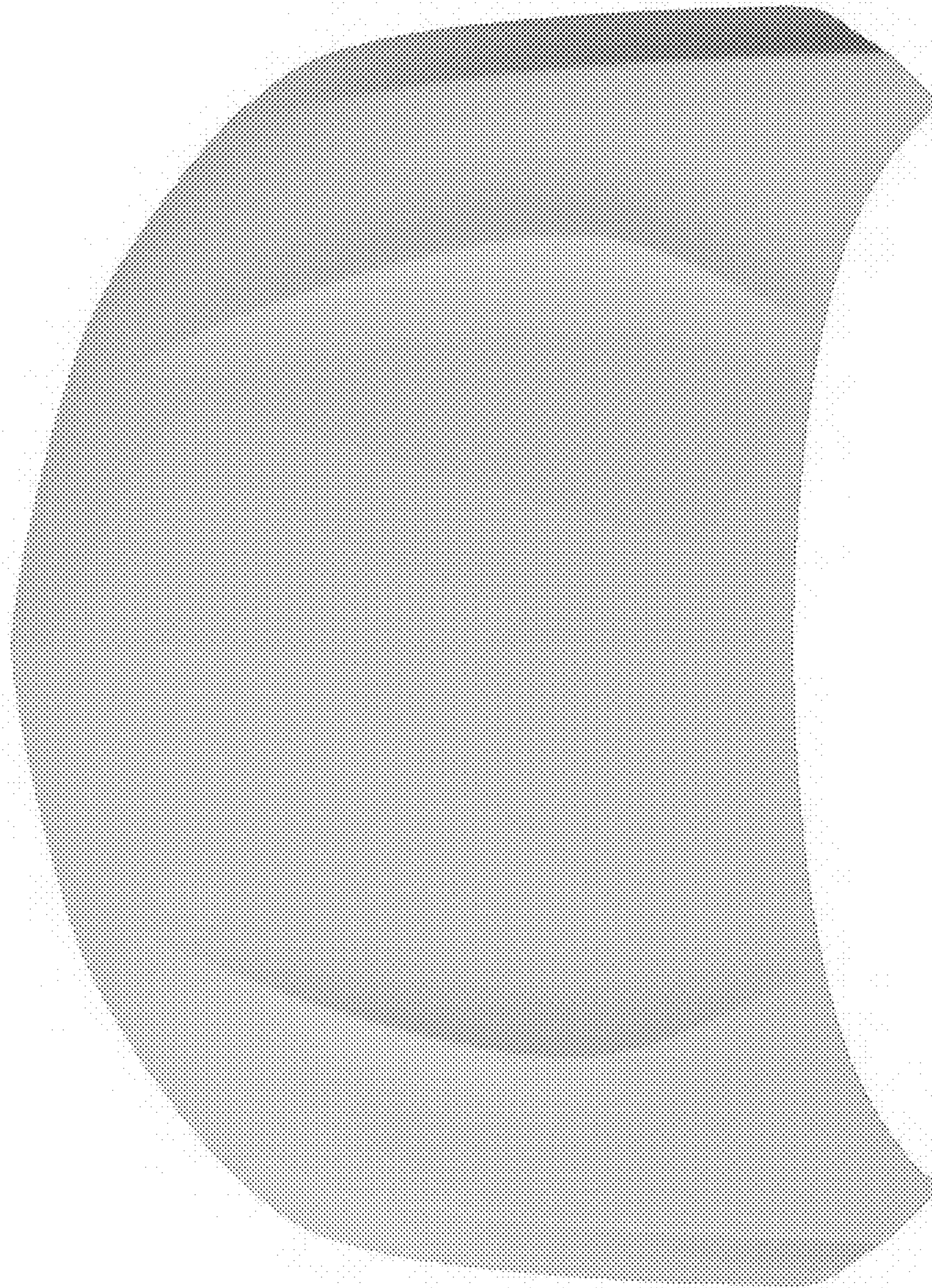

FIG. 9

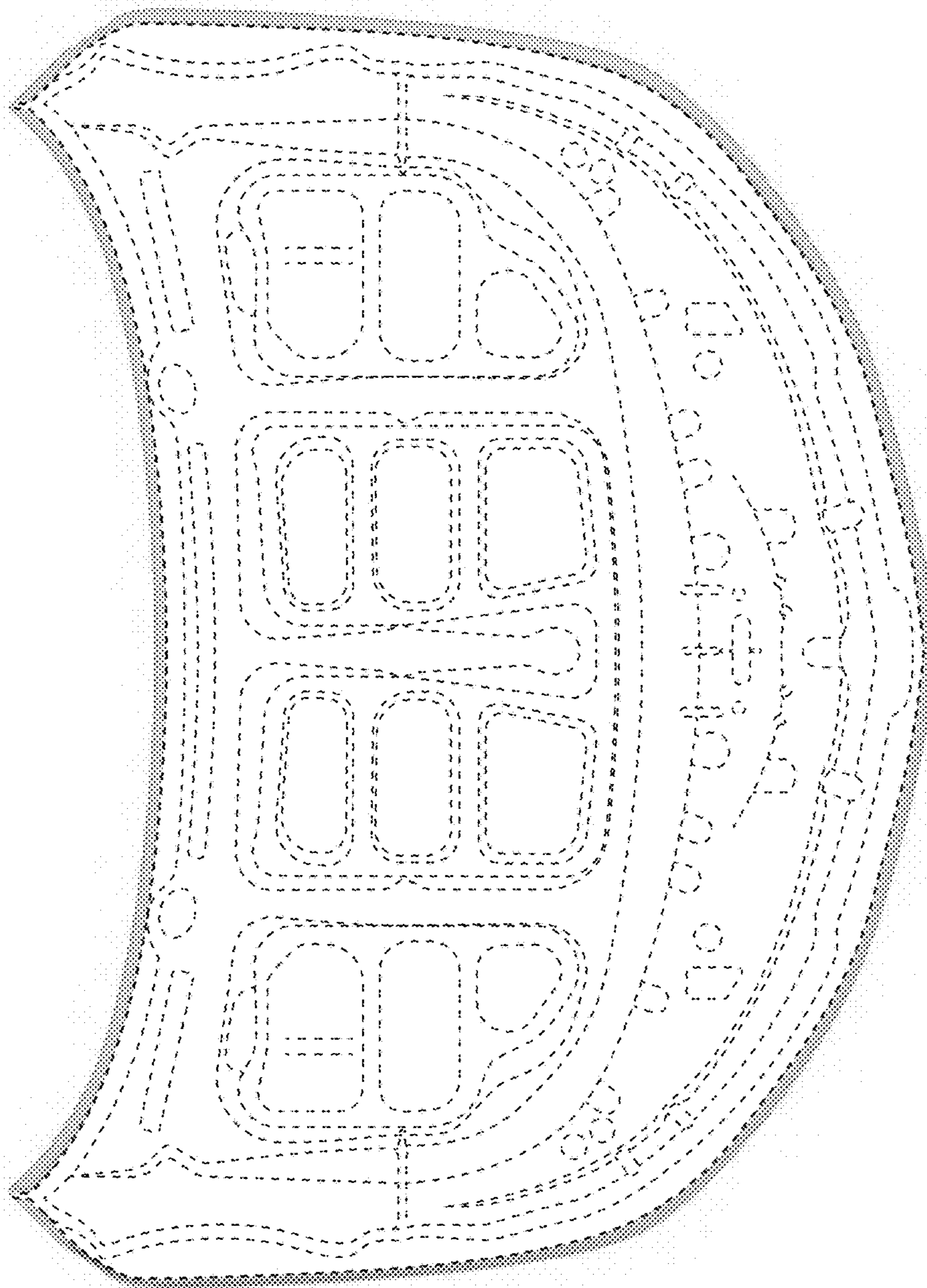

FIG. 10



FIG. 11

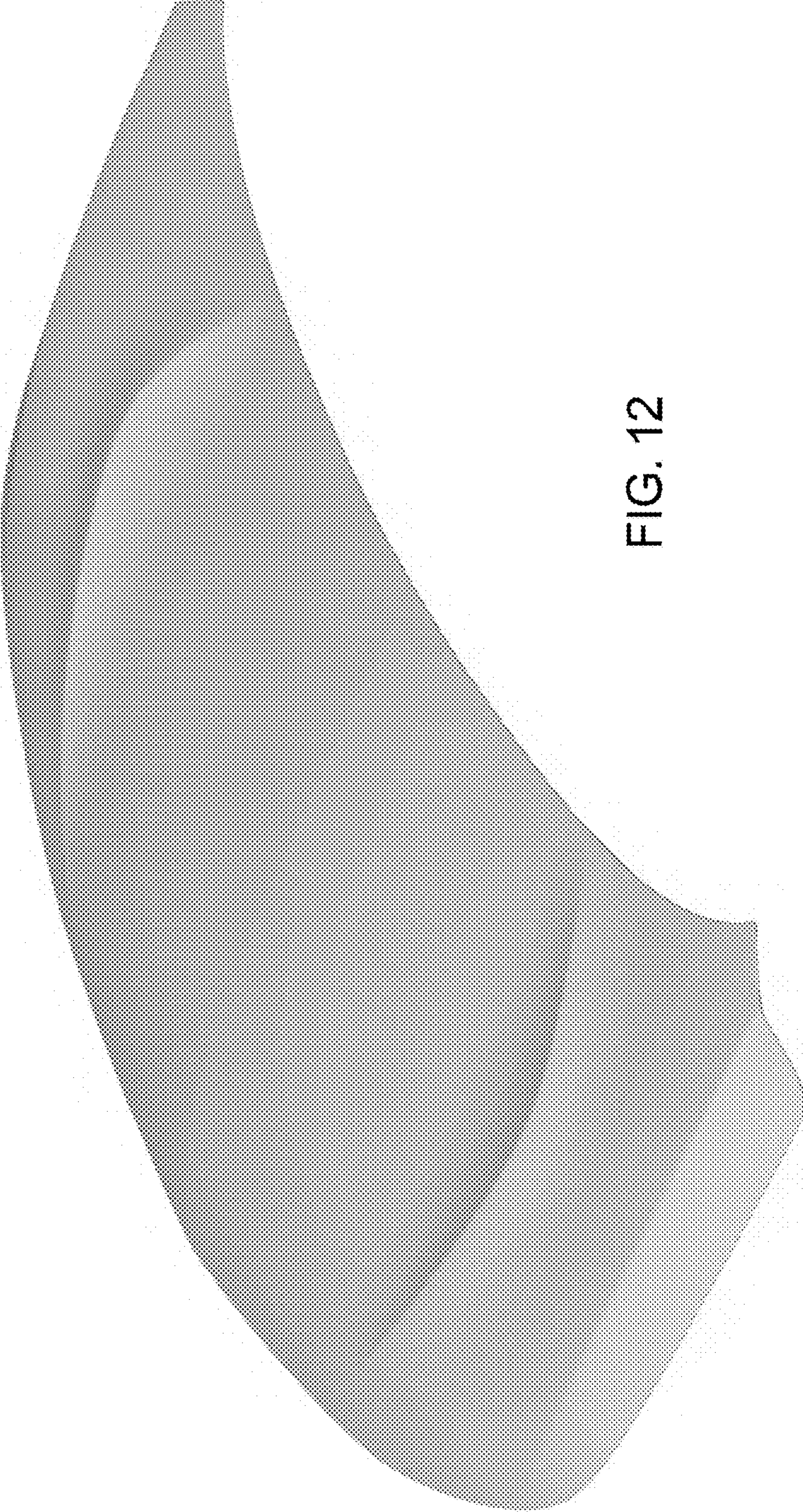

FIG. 12

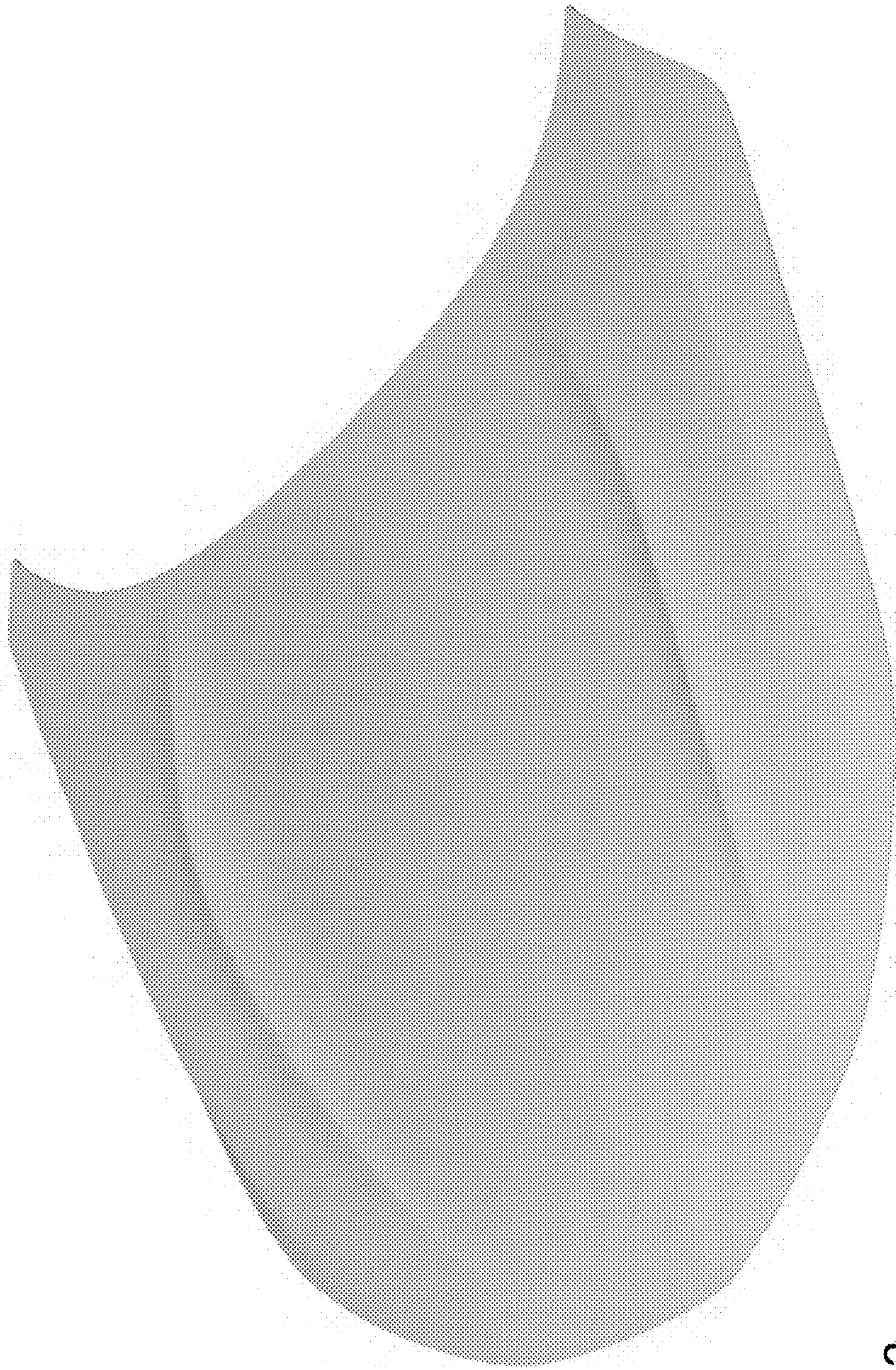

FIG. 13



FIG. 14

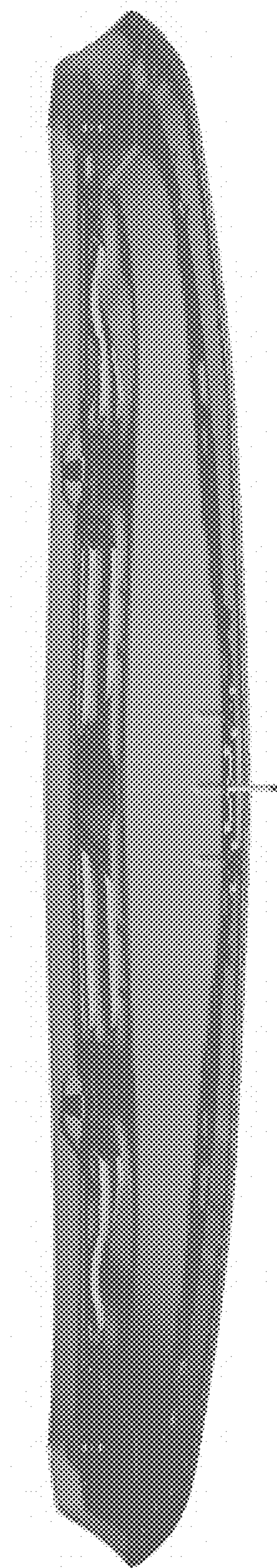

FIG. 15

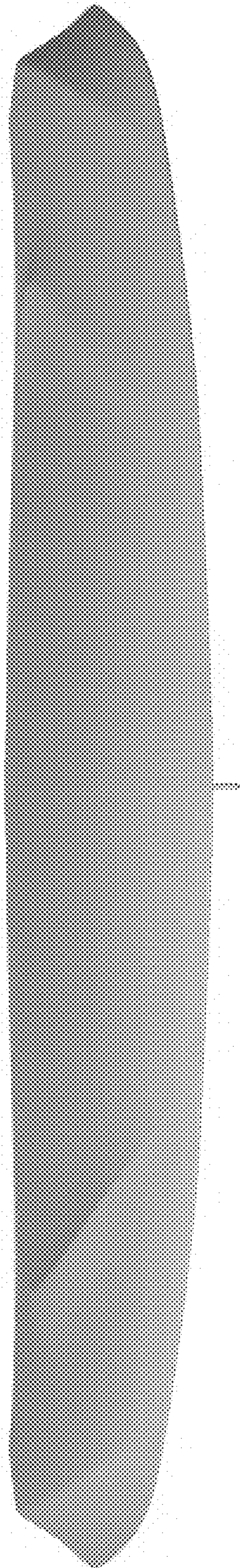

FIG. 16

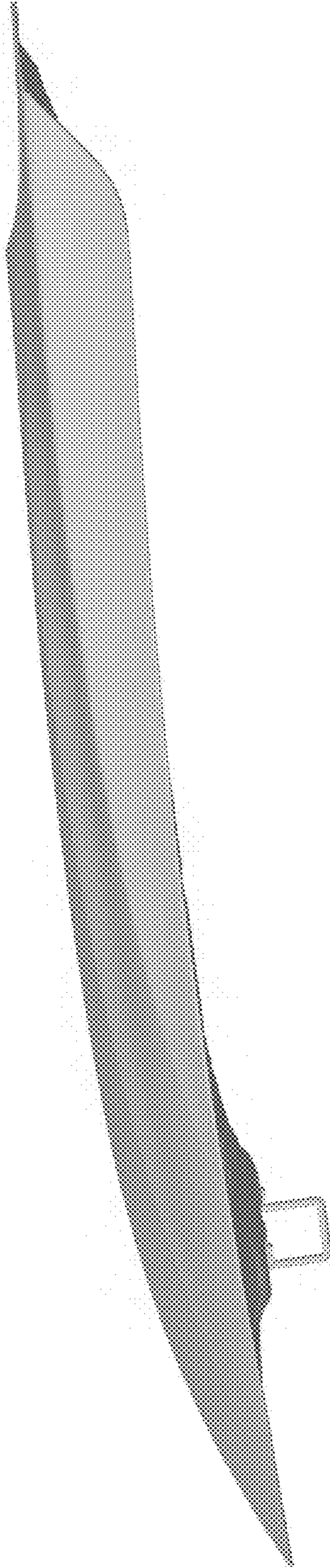

FIG. 17

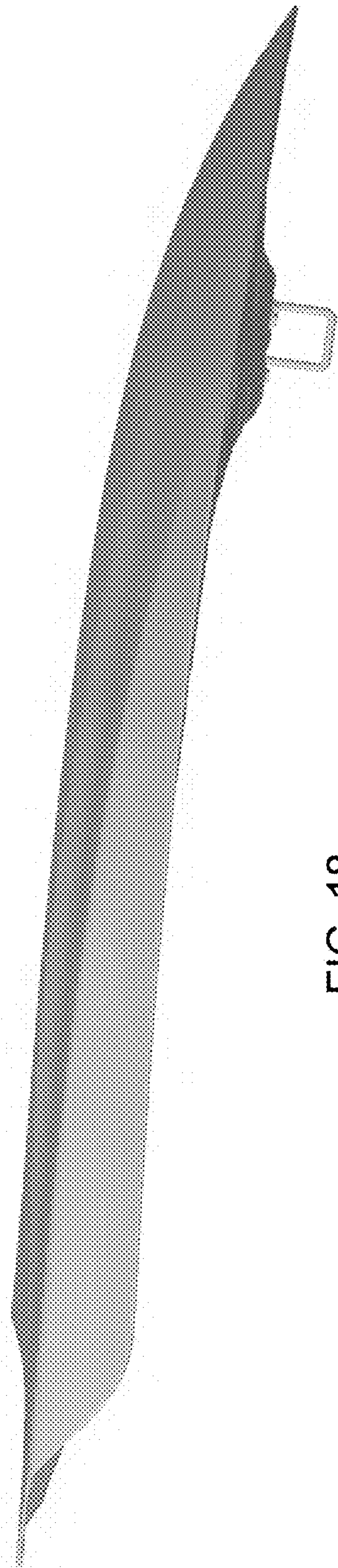

FIG. 18



FIG. 19



FIG. 20