



US00D865568S

(12) **United States Design Patent** (10) **Patent No.:** **US D865,568 S**
Burki (45) **Date of Patent:** **** Nov. 5, 2019**

(54) **MOTOR VEHICLE, TOY AND/OR REPLICA**

(71) Applicant: **Dr. Ing. h.c. F. Porsche Aktiengesellschaft, Stuttgart (DE)**

(72) Inventor: **Emiel Burki, Stuttgart (DE)**

(73) Assignee: **Dr. Ing. h.c. F. Porsche Aktiengesellschaft (DE)**

(**) Term: **15 Years**

(21) Appl. No.: **29/621,328**

(22) Filed: **Oct. 6, 2017**

(30) **Foreign Application Priority Data**

Apr. 7, 2017 (DE) 40 2017 100 461

(51) **LOC (12) Cl.** **12-08**

(52) **U.S. Cl.**
USPC **D12/92**

(58) **Field of Classification Search**
USPC D12/86, 90-92; D21/424, 433, 434, 533;
296/181.1-181.5, 183.1
CPC B62D 25/00; B62D 25/06; B62D 33/00;
B62D 35/00
See application file for complete search history.

(56) **References Cited**

U.S. PATENT DOCUMENTS

D338,638 S 8/1993 Lagaay
D592,553 S 5/2009 Larson
D592,554 S 5/2009 Larson
D610,041 S 2/2010 Larson

D690,232 S 9/2013 Scheinhutte et al.
D690,620 S 10/2013 Scheinhutte et al.
D700,545 S 3/2014 Borkert
D703,585 S 4/2014 Scheinhutte et al.
D704,100 S 5/2014 Scheinhutte et al.
D763,736 S * 8/2016 Varga D12/92
D763,737 S * 8/2016 Varga D12/92
D789,251 S 6/2017 Varga
D789,832 S 6/2017 Varga
D796,997 S 9/2017 Varga
D798,194 S 9/2017 Varga
D826,093 S * 8/2018 Manzoni D12/92
D829,609 S * 10/2018 Niimi D12/92
D830,910 S * 10/2018 Tamatani D12/92
D834,455 S * 11/2018 Yamashita D12/92

* cited by examiner

Primary Examiner — Melody N Brown

(74) *Attorney, Agent, or Firm* — RatnerPrestia

(57) **CLAIM**

The ornamental design for a motor vehicle, toy and/or replica, as shown and described.

DESCRIPTION

FIG. 1 is a front perspective view of a motor vehicle, toy and/or replica;
FIG. 2 is a front elevation view thereof;
FIG. 3 is a rear elevation view thereof;
FIG. 4 is an elevation view thereof taken from the side, the left side being a substantial mirror image thereof; and,
FIG. 5 is a top plan view thereof.
The portions of the vehicle shown in broken lines are for illustrative and environmental purposes and form no part of the claimed design.

1 Claim, 5 Drawing Sheets

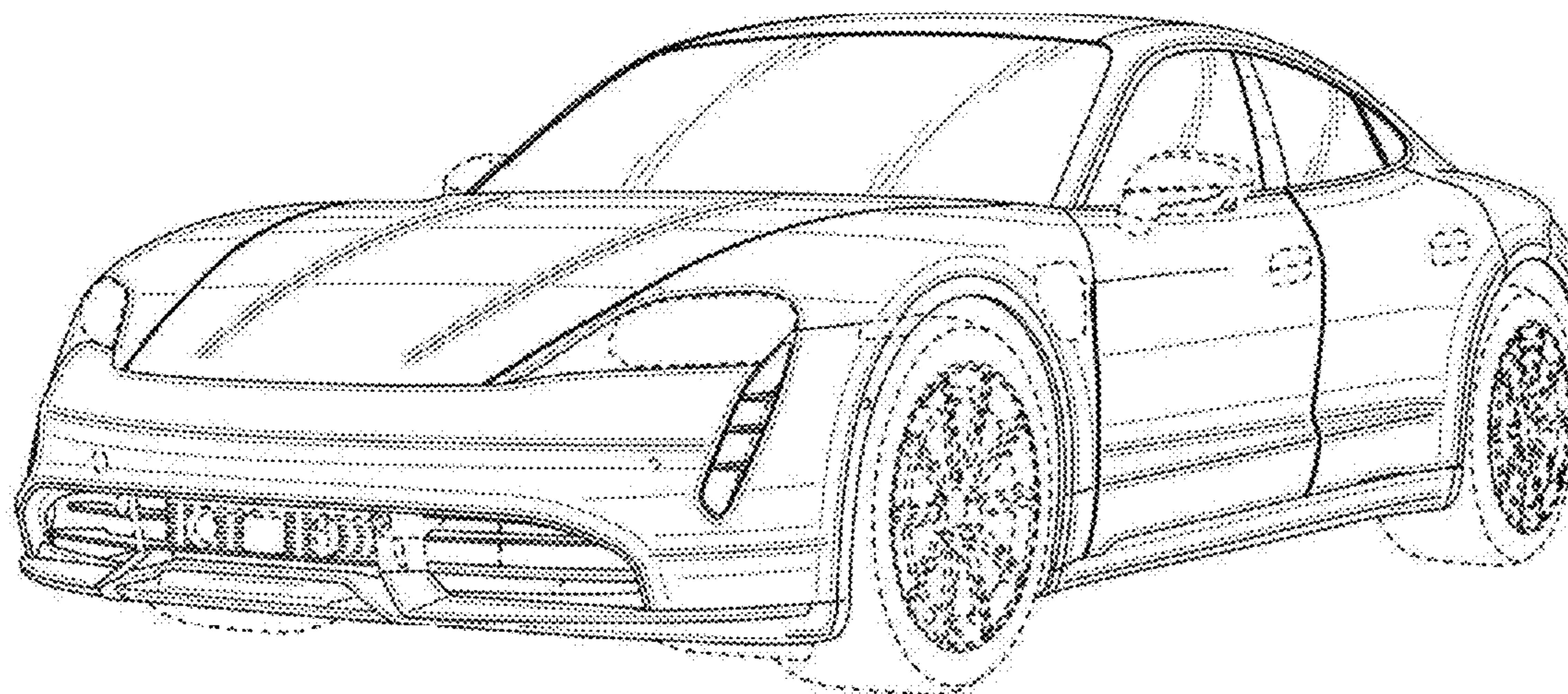

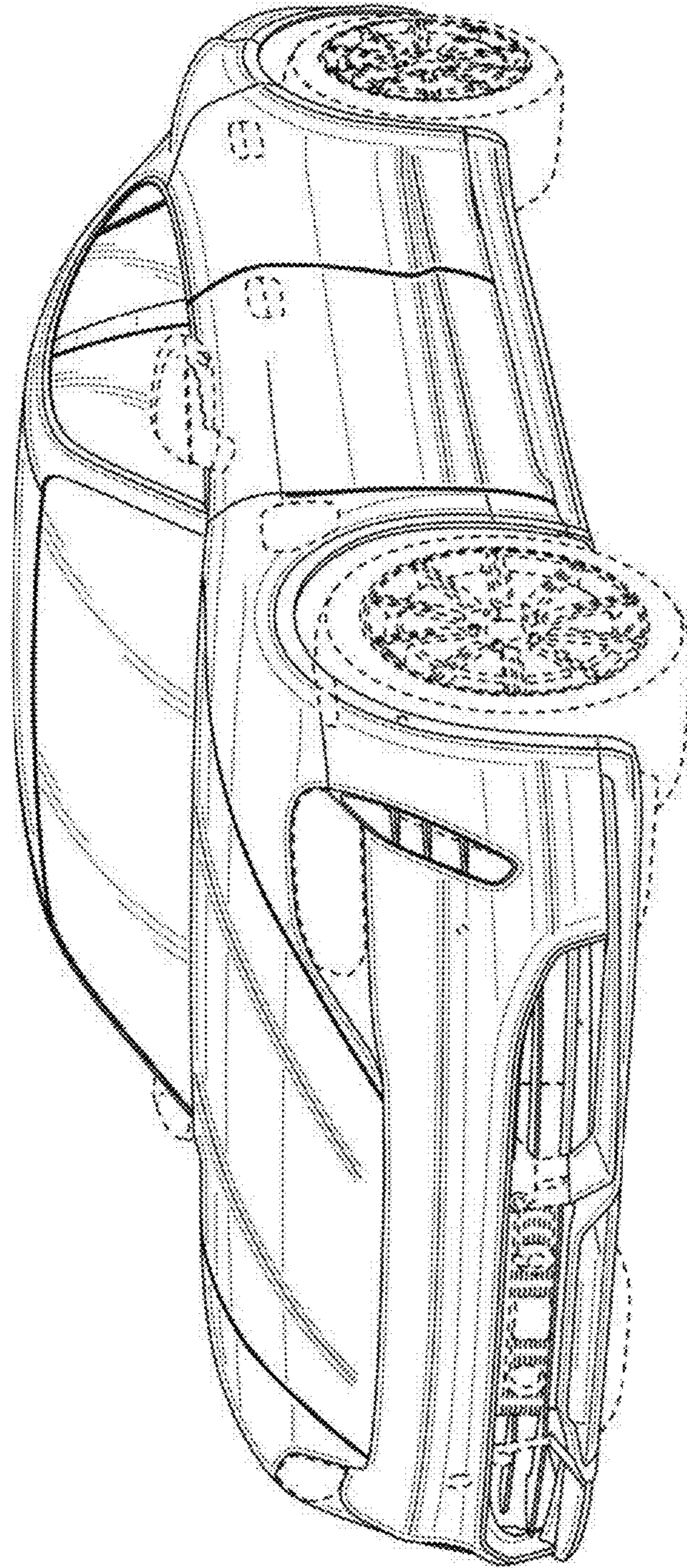

FIG. 1

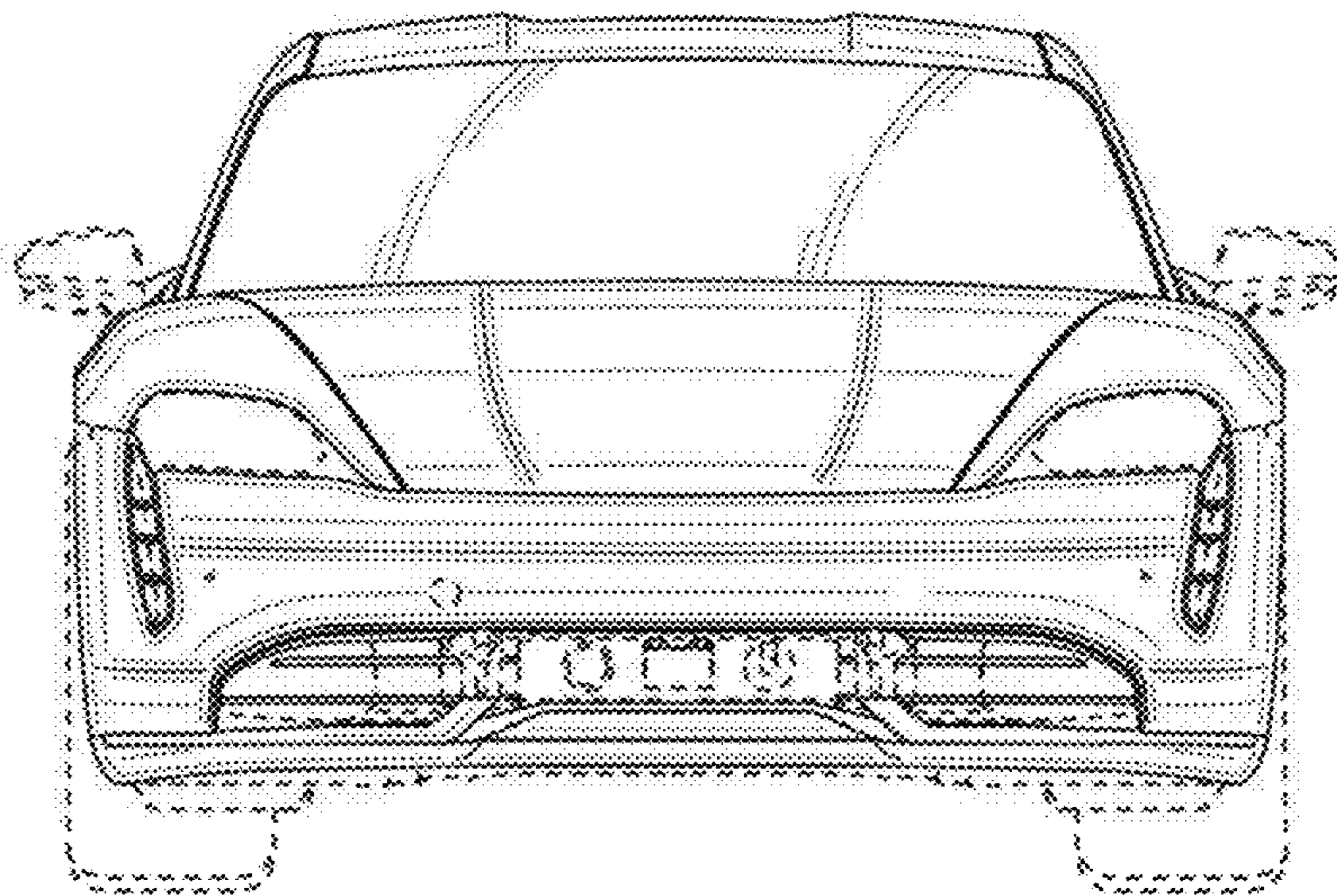

FIG. 2

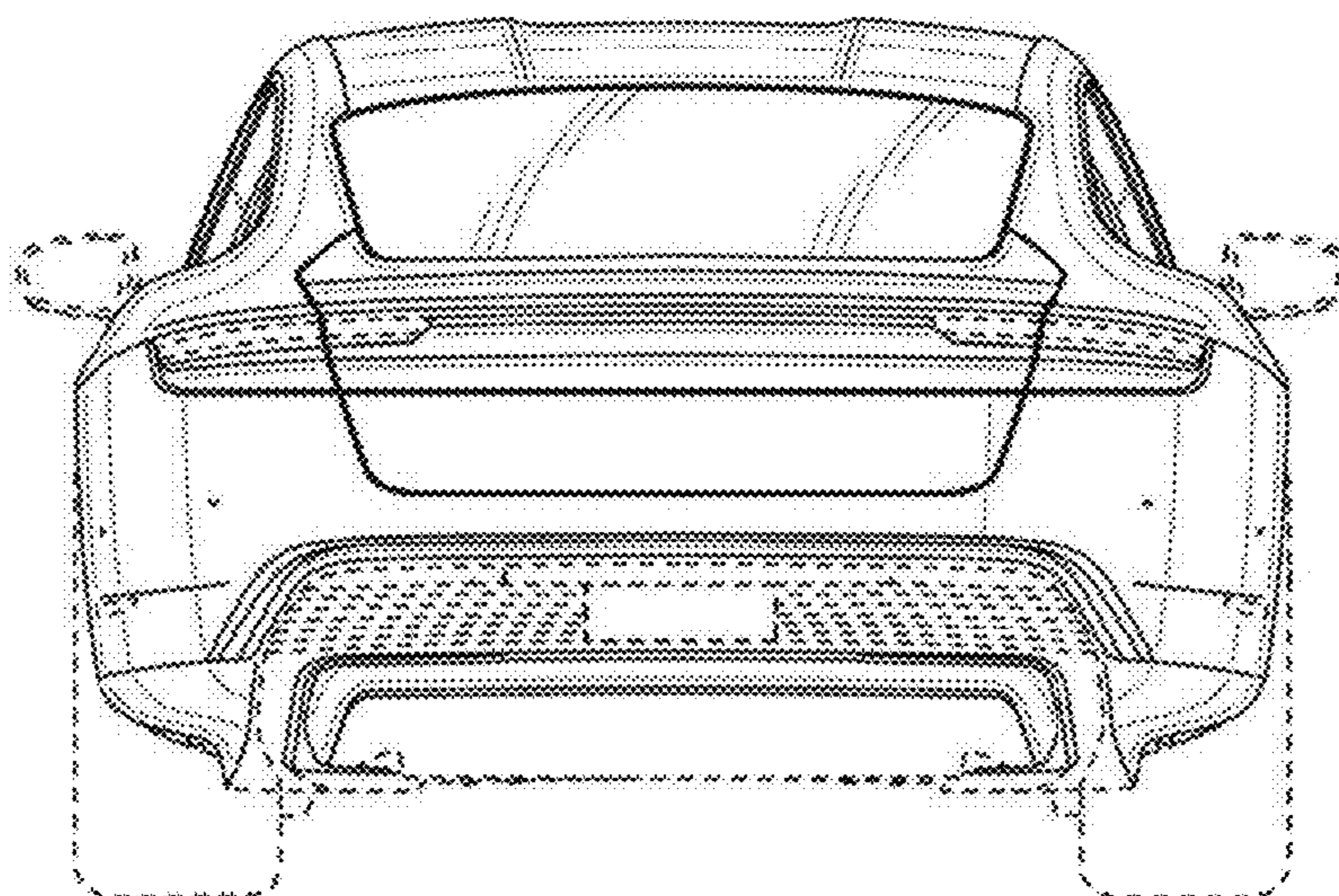

FIG. 3

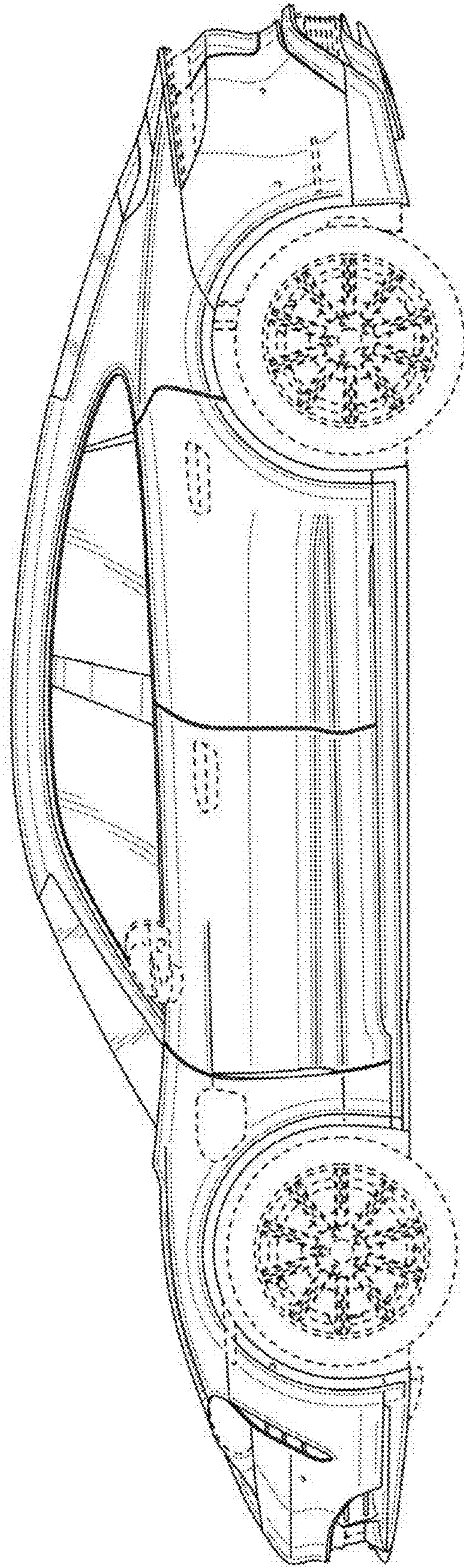

FIG. 4

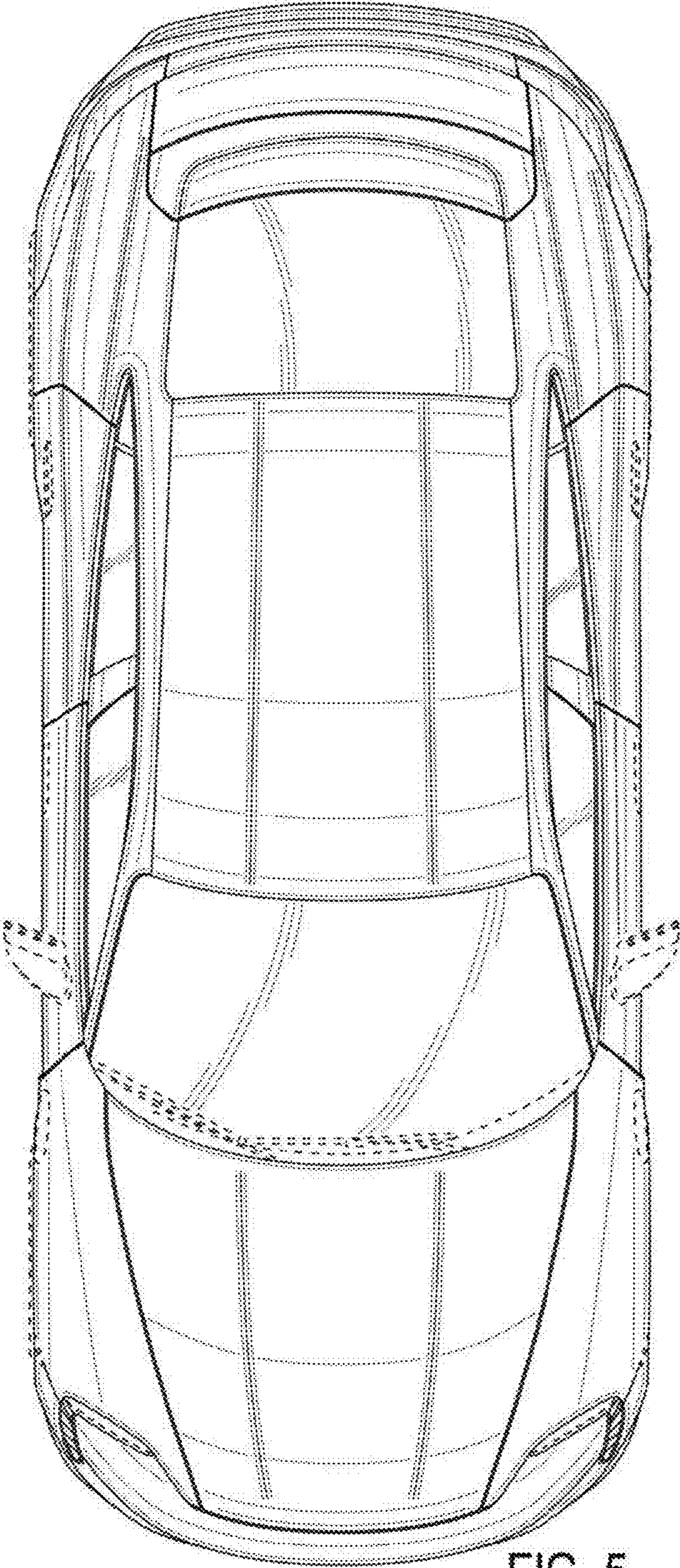

FIG. 5

UNITED STATES PATENT AND TRADEMARK OFFICE
CERTIFICATE OF CORRECTION

PATENT NO. : D865,568 S
APPLICATION NO. : 29/621328
DATED : November 5, 2019
INVENTOR(S) : Emiel Burki

Page 1 of 1

It is certified that error appears in the above-identified patent and that said Letters Patent is hereby corrected as shown below:

On the Title Page

Item [73], "Aktienfesellschaft" should read --Aktiengesellschaft--.

Signed and Sealed this
Twenty-first Day of January, 2020

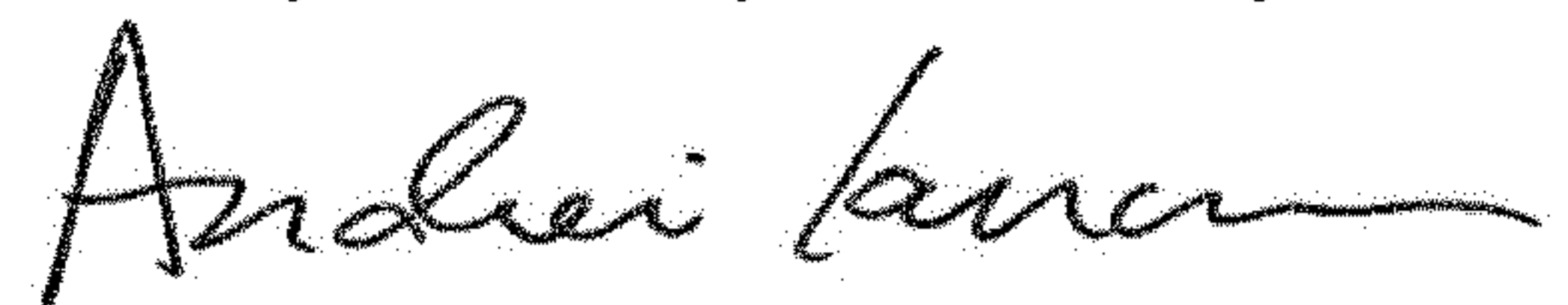

Andrei Iancu
Director of the United States Patent and Trademark Office