

US00D865512S

(12) **United States Design Patent** (10) **Patent No.:** **US D865,512 S**
Johnston et al. (45) **Date of Patent:** **** Nov. 5, 2019**

- (54) **DISPENSER BOX**
- (71) Applicant: **Innovate Medical, LLC**, Johnson City, TN (US)
- (72) Inventors: **Susan Johnston**, Gray, TN (US); **Steve Johnston**, Gray, TN (US)
- (73) Assignee: **Innovate Medical, LLC**, Johnson City, TN (US)

(**) Term: **15 Years**

(21) Appl. No.: **29/645,438**

(22) Filed: **Apr. 26, 2018**

(51) **LOC (12) Cl.** **09-03**

(52) **U.S. Cl.**
USPC **D9/423**

(58) **Field of Classification Search**
USPC D9/414-418, 420, 423, 730, 734
CPC ... B65D 5/02; B65D 5/18; B65D 5/54; B65D 5/66; B65D 5/72; B65D 5/723; B65D 5/6661; B65D 83/08; B65D 83/0805; B65D 83/0841; B65D 83/0847; A47K 10/00; A47K 10/42; A47K 10/185; A47K 10/421; A47K 10/426; A47K 10/3818
See application file for complete search history.

(56) **References Cited**

U.S. PATENT DOCUMENTS

2,199,204	A *	4/1940	Levkoff	B65D 5/6661
					206/45.28
D283,796	S *	5/1986	Schuster	D9/418
D400,095	S *	10/1998	Uebele	D9/734
D504,812	S *	5/2005	Keberlein	D7/631
D563,219	S *	3/2008	Okin	D9/423
D680,859	S *	4/2013	Levy	D9/423

D738,202	S *	9/2015	Stone	D9/418
D746,674	S *	1/2016	Wollschleger	B65D 83/04
					D9/416
D777,026	S *	1/2017	Sanfilippo	D9/416
D778,149	S *	2/2017	Frick	D9/416
D824,758	S *	8/2018	Baldino	B65D 71/36
					D9/416
2013/0228588	A1 *	9/2013	Biegger	B65D 83/0847
					221/45
2017/0327267	A1 *	11/2017	Jolley	B65D 5/321
2019/0135482	A1 *	5/2019	Pratsch	B65D 5/542

* cited by examiner

Primary Examiner — Wan Laymon

Assistant Examiner — Clint A Samuel

(74) *Attorney, Agent, or Firm* — Pitts & Lake, P.C.

(57) **CLAIM**

The ornamental design for a dispenser box, as shown and described.

DESCRIPTION

FIG. 1 is a perspective view of the design of the present invention for a dispenser box;
 FIG. 2 is a front elevation view of the dispenser box shown in FIG. 1;
 FIG. 3 is a rear elevation view of the dispenser box shown in FIG. 1;
 FIG. 4 is a side elevation view of the dispenser box shown in FIG. 1 with the box lid in a partially closed position;
 FIG. 5 is a side elevation view of the dispenser box shown in FIG. 1 with the box lid in a substantially closed position;
 FIG. 6 is a top view of the dispenser box shown in FIG. 1;
 and,
 FIG. 7 is a bottom view of the dispenser box shown in FIG. 1.

1 Claim, 4 Drawing Sheets

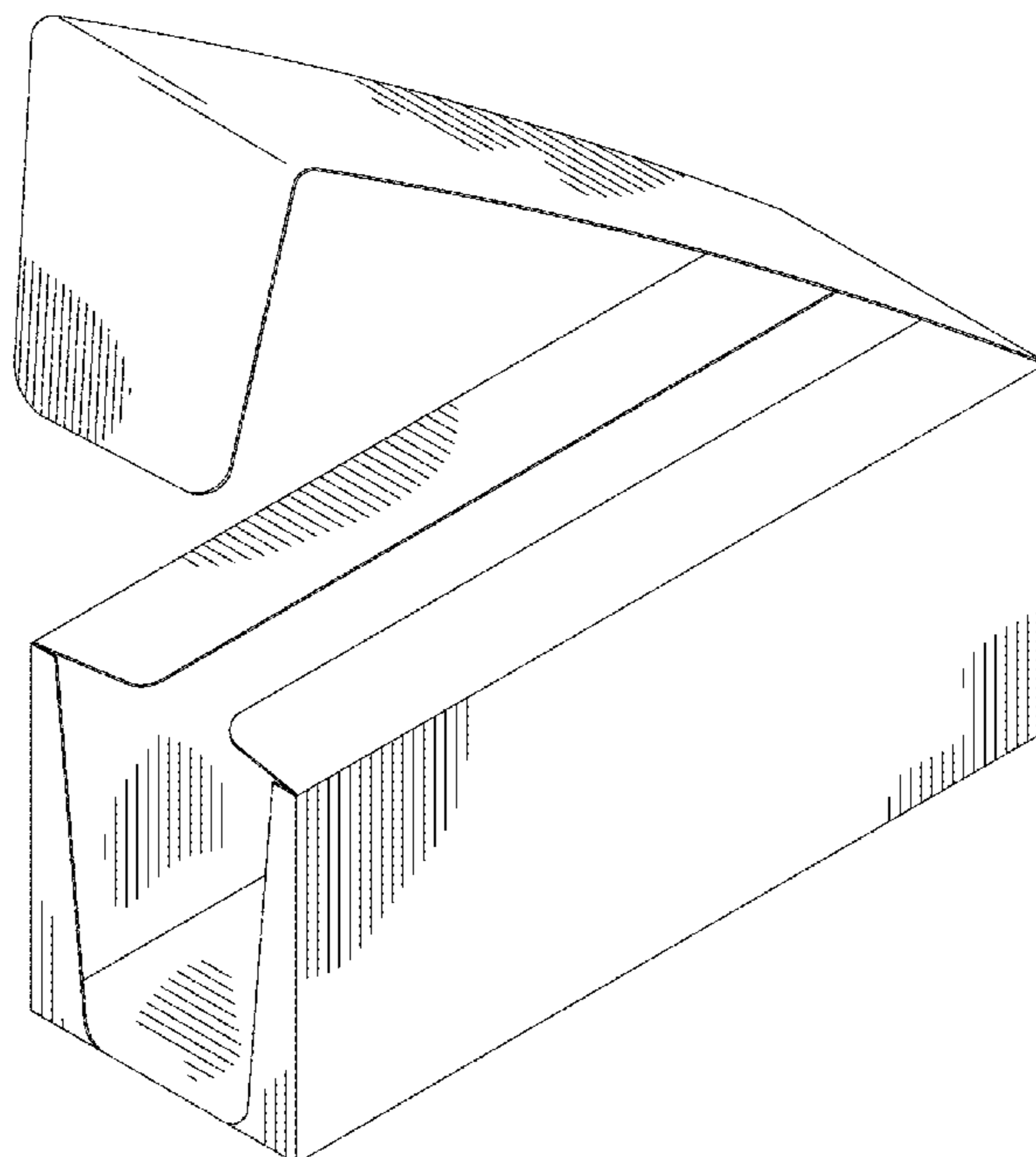

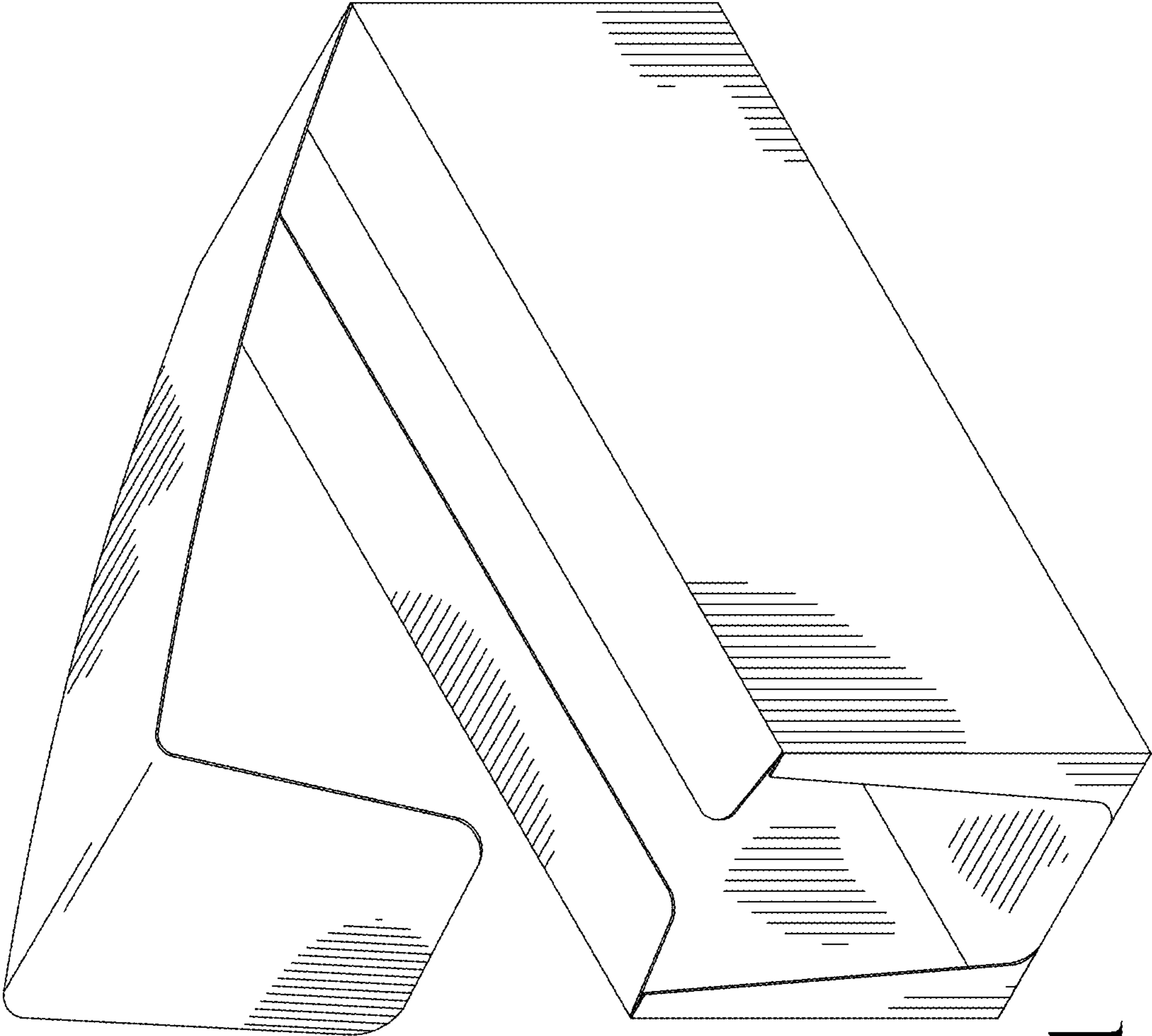

Fig. 1

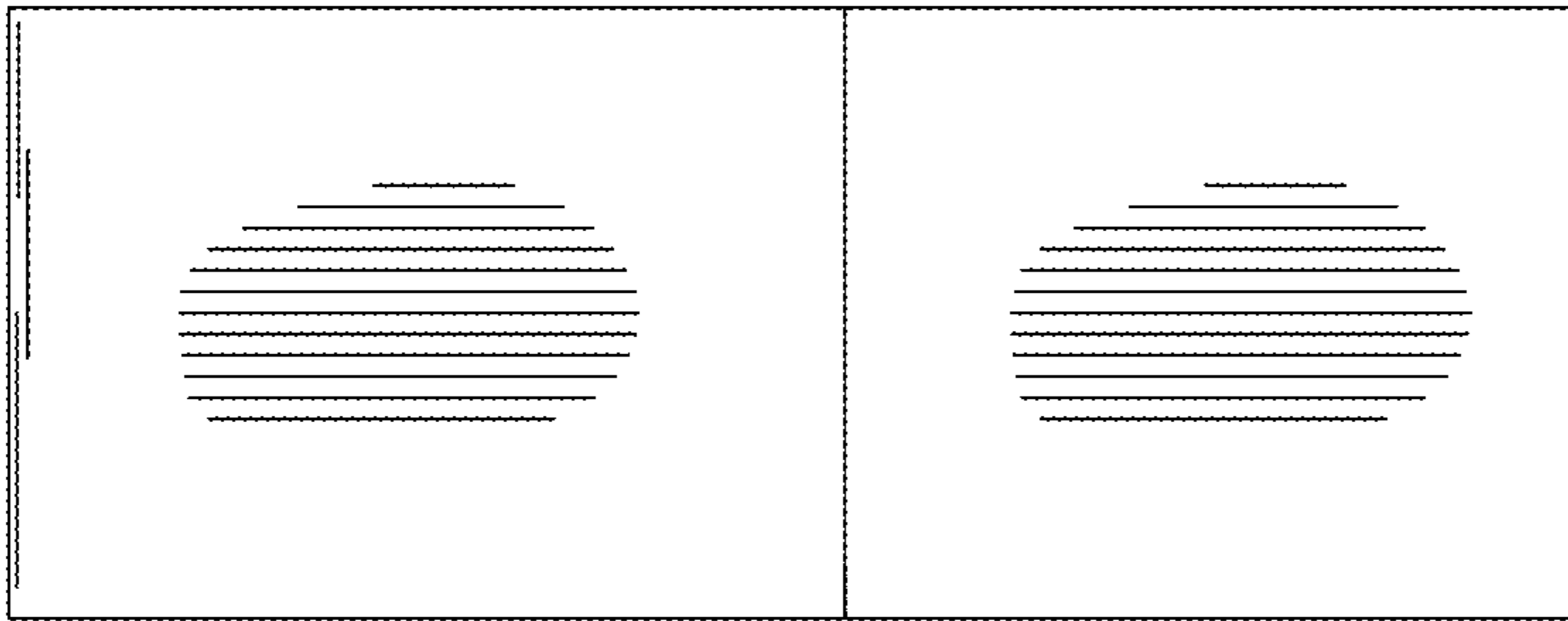

Fig. 3

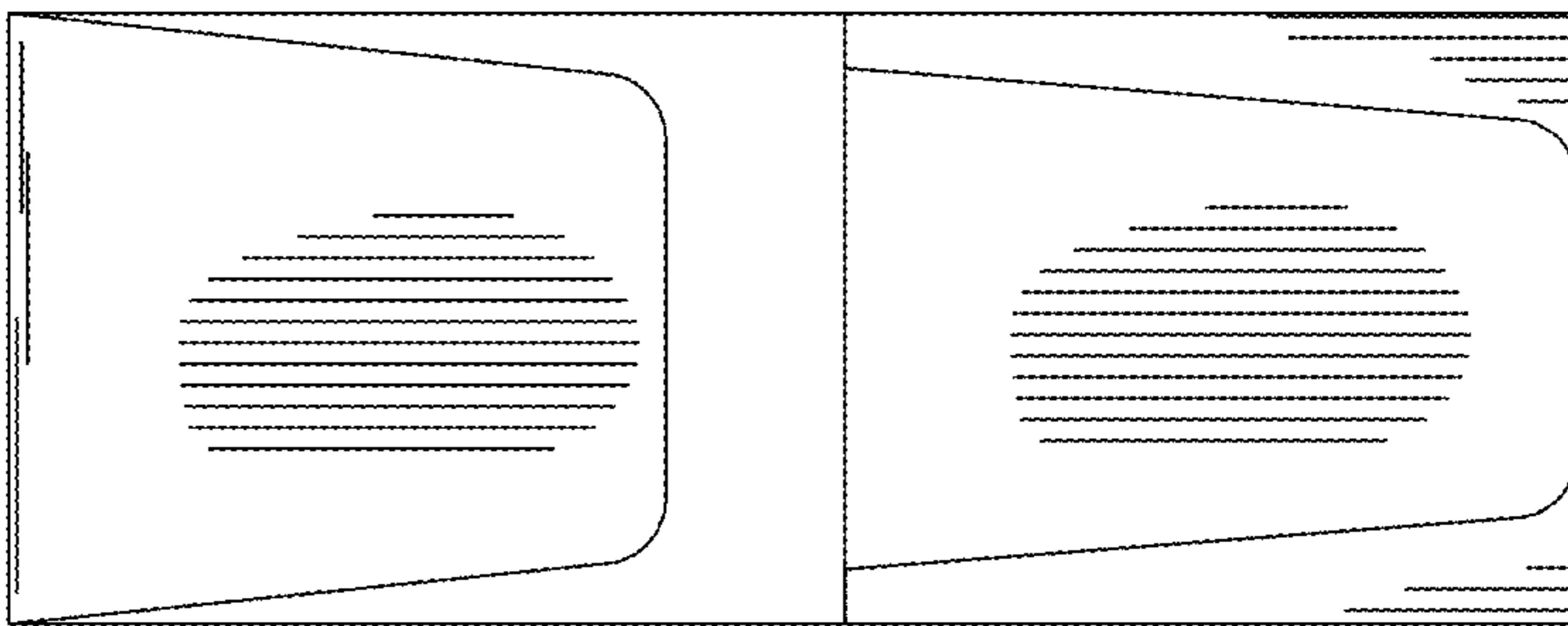

Fig. 2

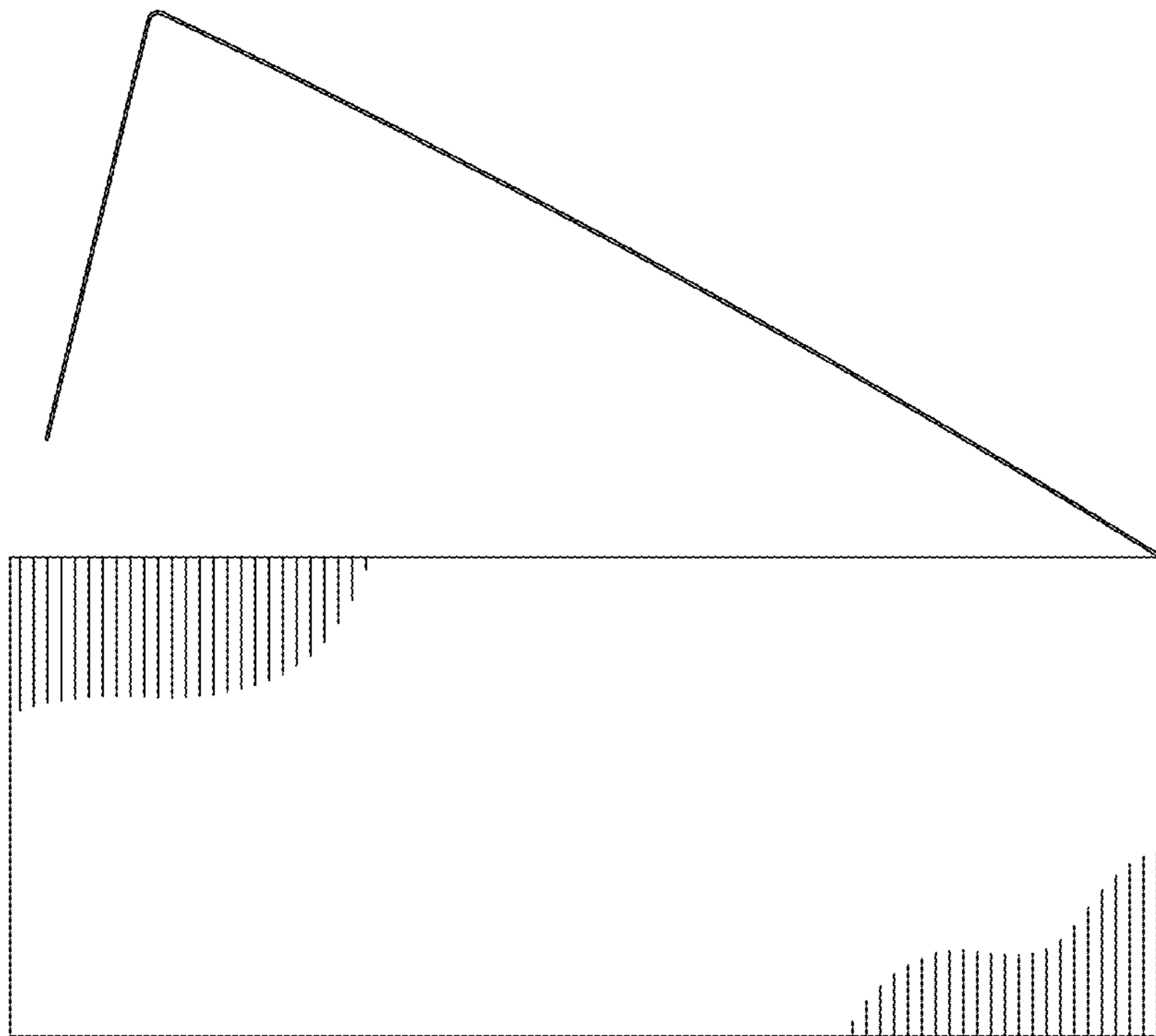

Fig. 4

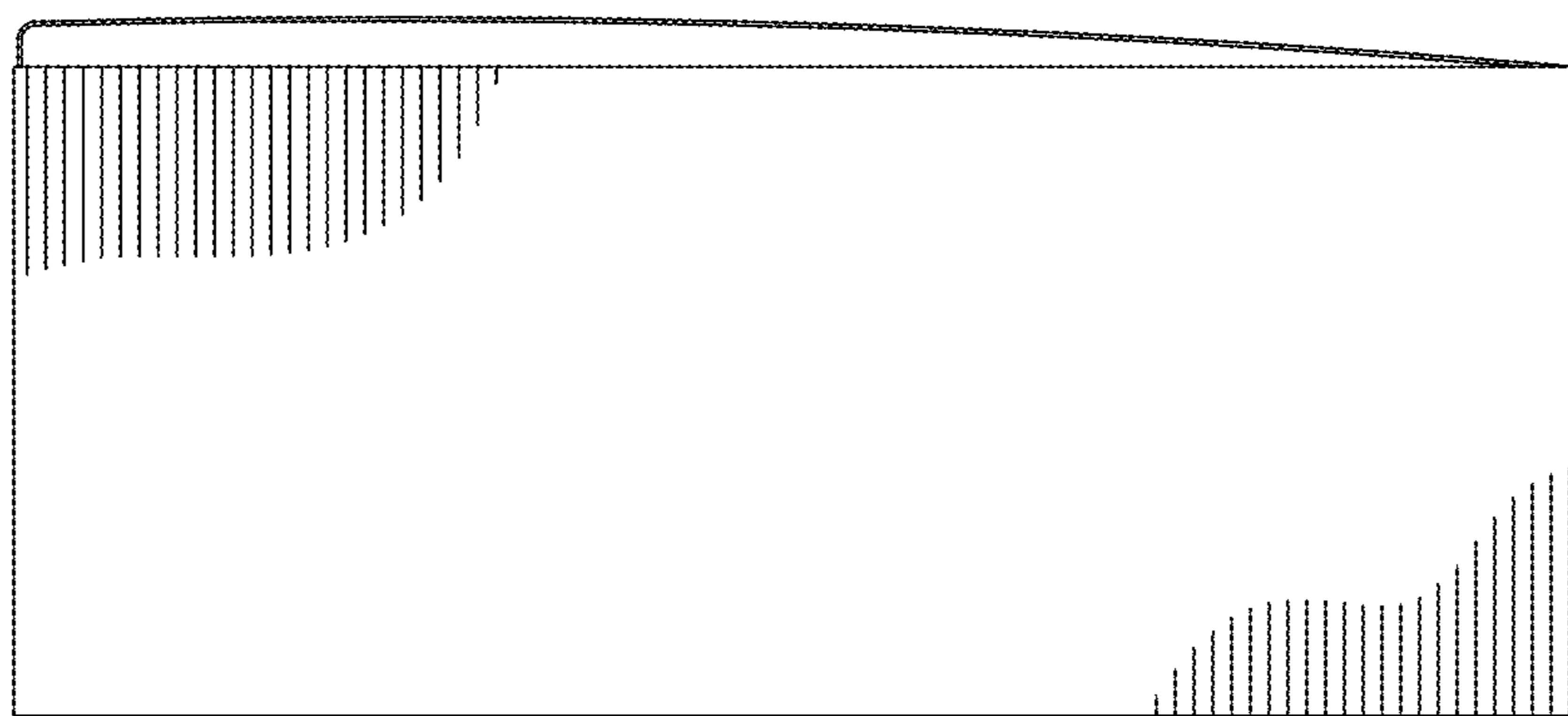

Fig. 5

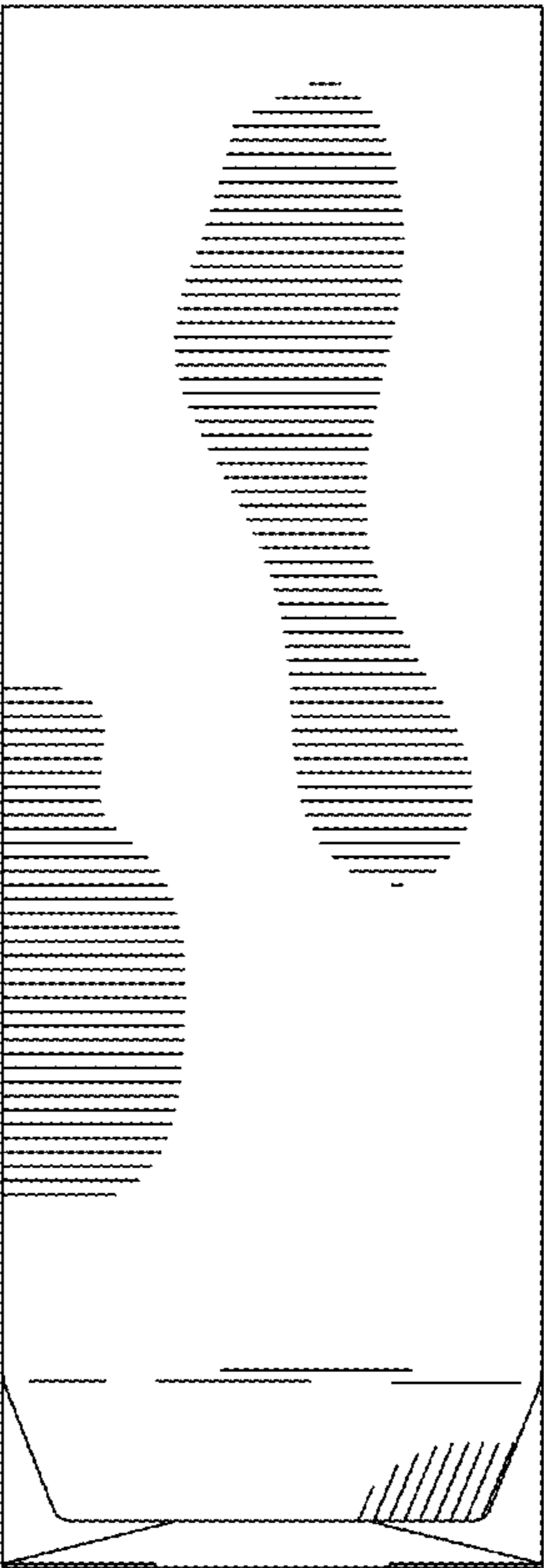

Fig. 6

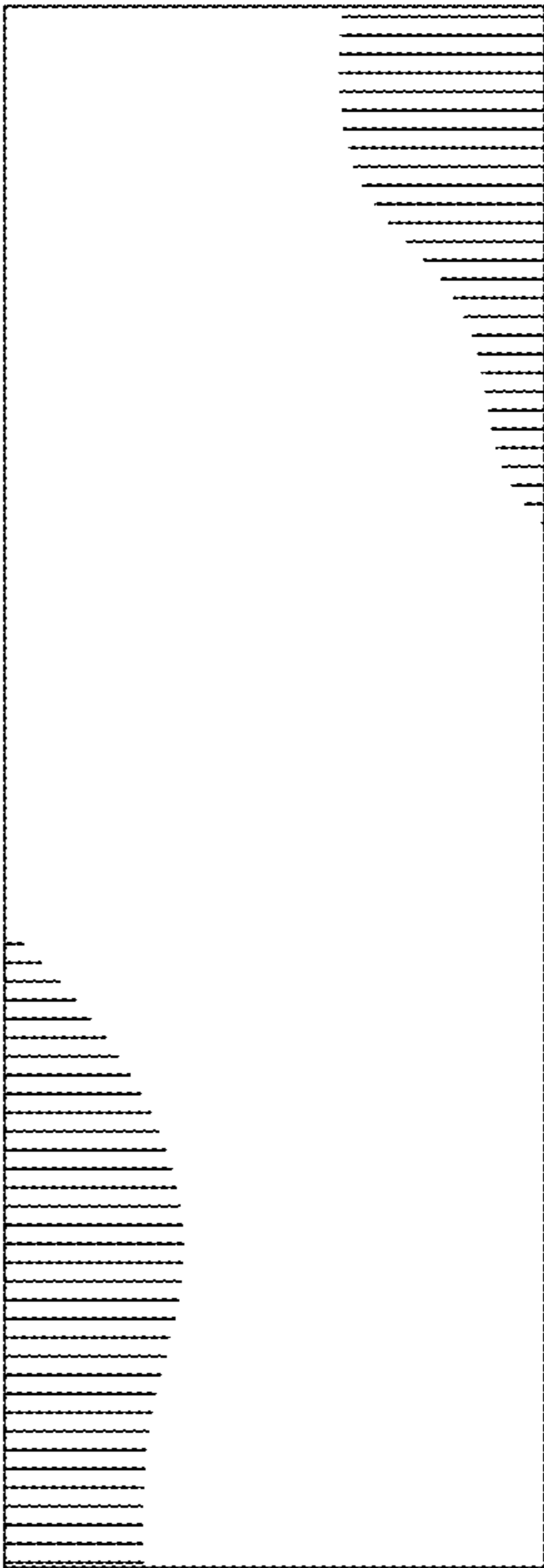

Fig. 7