



US00D865491S

(12) **United States Design Patent** (10) **Patent No.:** **US D865,491 S**
Noack (45) **Date of Patent:** **** Nov. 5, 2019**

- (54) **CLEAT**
- (71) Applicant: **Valley Hook, LLC**, Waterford, WI (US)
- (72) Inventor: **Charles J. Noack**, Waterford, WI (US)
- (73) Assignee: **Valley Hook, LLC**, Waterford, WI (US)
- (**) Term: **15 Years**
- (21) Appl. No.: **29/666,328**
- (22) Filed: **Oct. 11, 2018**
- (51) **LOC (12) Cl.** **09-06**
- (52) **U.S. Cl.**
USPC **D8/356**
- (58) **Field of Classification Search**
USPC D8/356, 354, 349; 361/826
CPC A63B 29/00; A63B 27/00; B63B 59/02;
B63B 21/045; H05K 5/0247
See application file for complete search history.

(56) **References Cited**

U.S. PATENT DOCUMENTS

1,583,343 A * 5/1926 Duerden F16G 11/14
24/129 R
1,666,623 A * 4/1928 Hoover 24/18
D81,983 S * 9/1930 Kanowitz 223/92
3,291,094 A 12/1966 Beebe
D233,312 S * 10/1974 Lock D24/143
3,905,322 A * 9/1975 Peterman B63B 21/045
114/218
4,173,194 A 11/1979 McLaughlin
D289,373 S * 4/1987 Kimball 24/130
4,957,232 A * 9/1990 Sprague A45F 5/02
224/249
D311,487 S * 10/1990 Platt D8/396
D321,470 S 11/1991 Gerrard
5,234,185 A * 8/1993 Hoffman et al. 248/56

D353,990 S * 1/1995 Alfreds D8/356
D390,447 S * 2/1998 Colen, Jr. D8/356
5,941,191 A 8/1999 Dysarz
6,092,444 A * 7/2000 Hsiao 81/440
D494,450 S * 8/2004 Schultz et al. D8/356
6,813,981 B2 * 11/2004 Urban et al. 83/13
7,353,766 B1 * 4/2008 Wiese B63B 21/045
114/218
D613,137 S * 4/2010 Wieberdink et al. D8/14
D624,378 S * 9/2010 Wysopal D8/40
D627,632 S * 11/2010 Elmer et al. D8/383
D660,740 S * 5/2012 Cullen et al. D11/3
D662,087 S * 6/2012 Peller D14/223
D675,123 S * 1/2013 Nunez D11/3
D684,845 S * 6/2013 Wood A62B 35/04
D8/356
D685,625 S * 7/2013 Diekman D8/356
8,615,849 B2 * 12/2013 Rothbaunn et al. 24/16 R

(Continued)

Primary Examiner — Cynthia R Underwood
(74) *Attorney, Agent, or Firm* — Boyle Fredrickson S.C.

(57) **CLAIM**

The ornamental design for a cleat, substantially as shown and described.

DESCRIPTION

FIG. 1 is a top, front and right side isometric view of a cleat according to the present invention;
FIG. 2 is a top plan view of the cleat of FIG. 1;
FIG. 3 is a bottom plan view of the cleat of FIG. 1;
FIG. 4 is a front elevation view of the cleat of FIG. 1;
FIG. 5 is a rear elevation view of the cleat of FIG. 1;
FIG. 6 is a left side elevation view of the cleat of FIG. 1; and,
FIG. 7 is a right side elevation view of the cleat of FIG. 1.
The broken lines in the figures depict portions of the cleat that form no part of the claimed design.

1 Claim, 4 Drawing Sheets

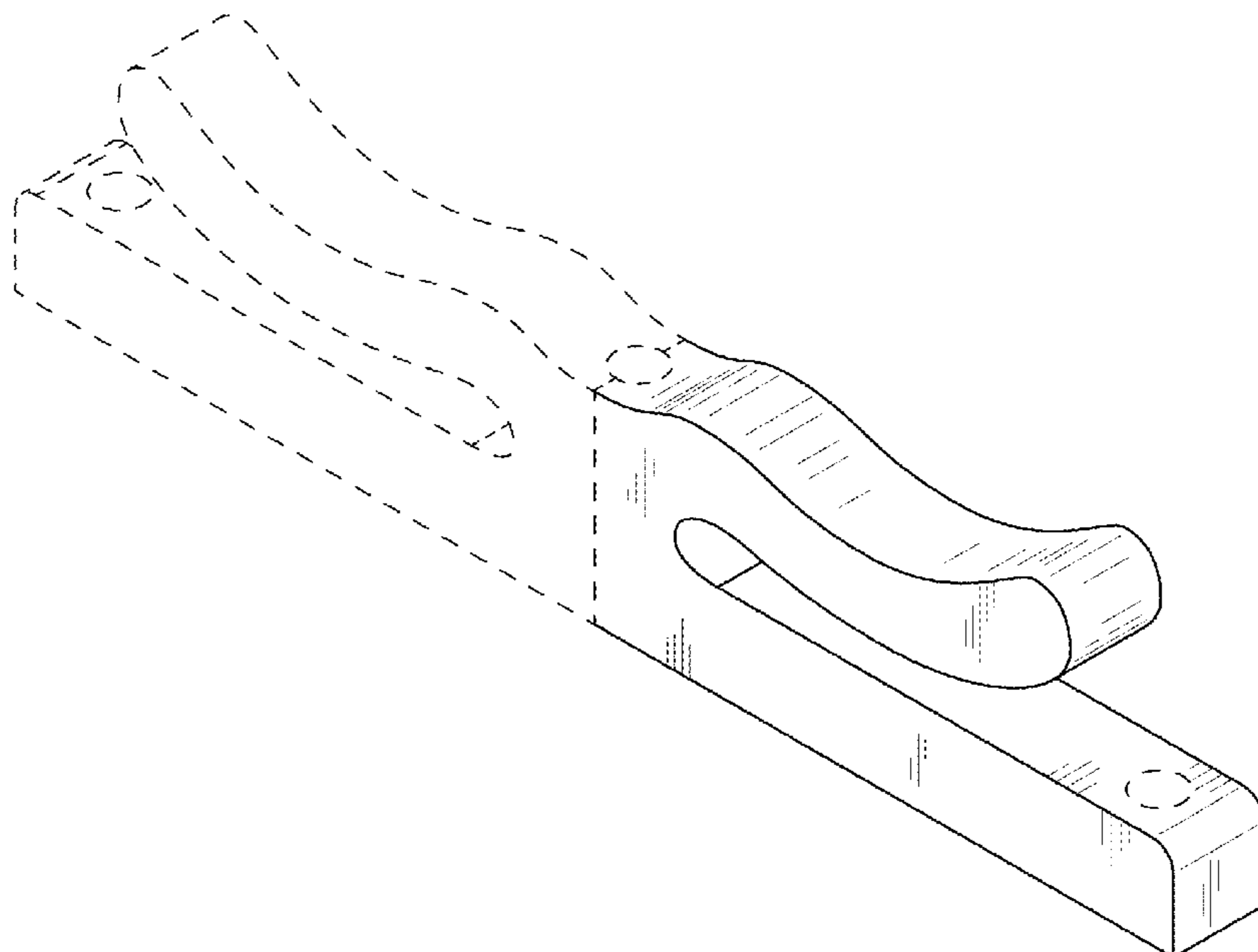

(56)

References Cited

U.S. PATENT DOCUMENTS

8,661,624 B1 * 3/2014 Bracewell B63B 21/08
24/129 B
D702,109 S * 4/2014 Weinberg D8/356
D715,624 S 10/2014 Thompson et al.
D737,502 S * 8/2015 Kirkham D26/143
D747,955 S * 1/2016 Franco D8/354
D762,461 S * 8/2016 Kirkham D8/356
D801,784 S * 11/2017 Simon D8/356
D808,890 S * 1/2018 Fenchak D12/414
D827,417 S * 9/2018 Nelson D8/356
D830,948 S * 10/2018 Fenchak D12/414
D839,084 S * 1/2019 Mikoska D8/356
D839,716 S * 2/2019 Gertsma D8/356
D839,719 S * 2/2019 Burrell D8/356
D839,720 S * 2/2019 Cunnington D8/356
2006/0135969 A1 * 6/2006 Assia A61F 2/16
606/151
2010/0160957 A1 * 6/2010 Kirkham A61B 17/1322
606/203
2011/0126382 A1 * 6/2011 Kirkham A61B 17/1322
24/16 R
2014/0196256 A1 * 7/2014 Garcia F16G 11/046
24/129 R

* cited by examiner

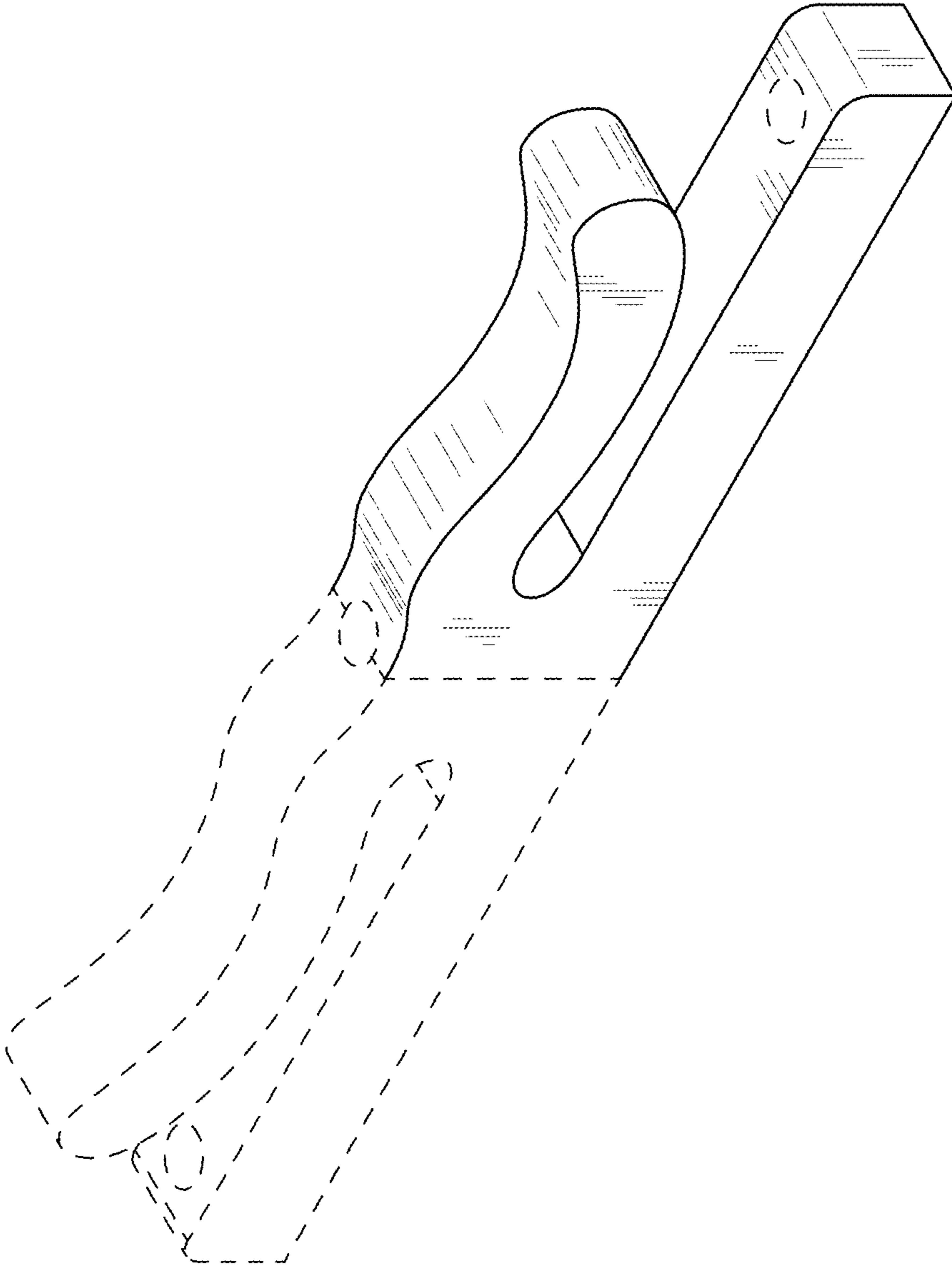

FIG. 1

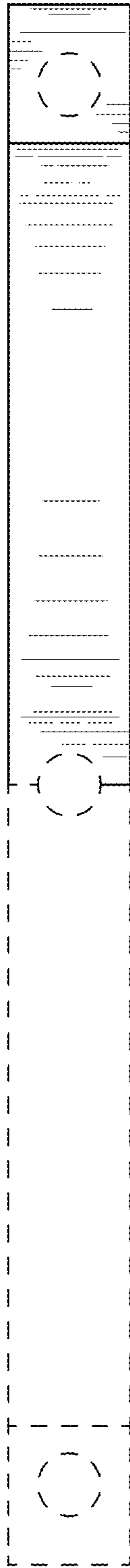

FIG. 2

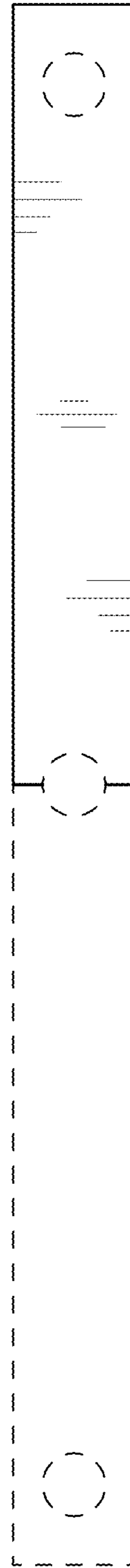

FIG. 3

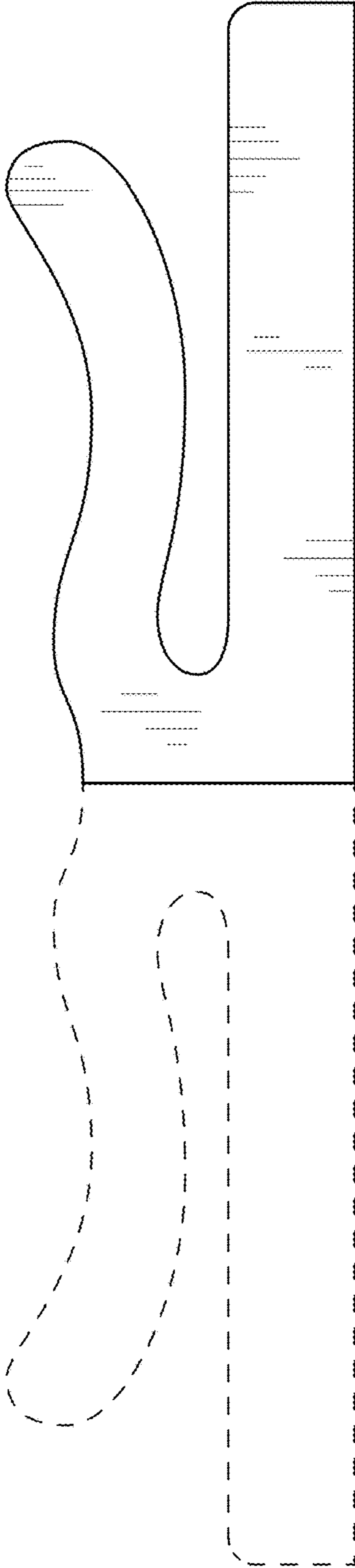

FIG. 4

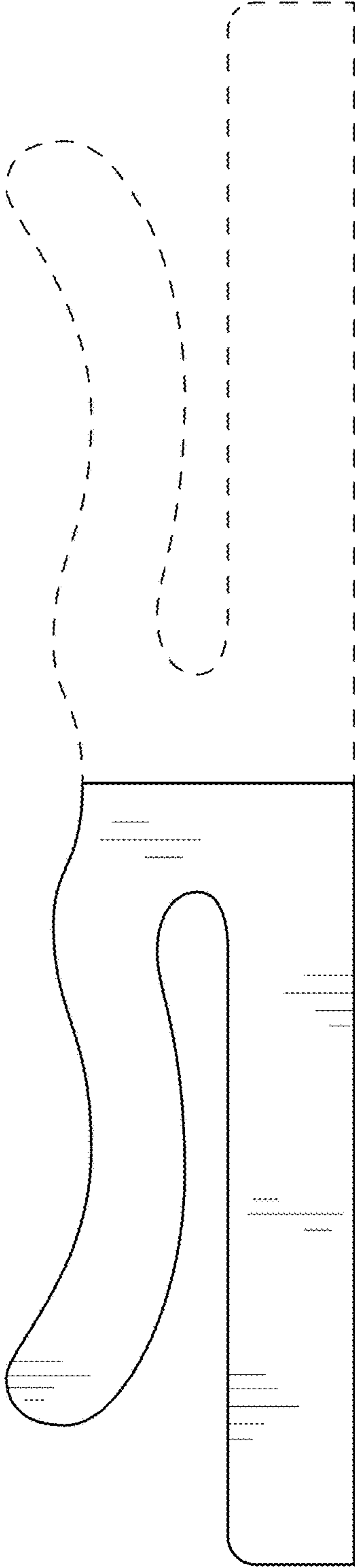

FIG. 5

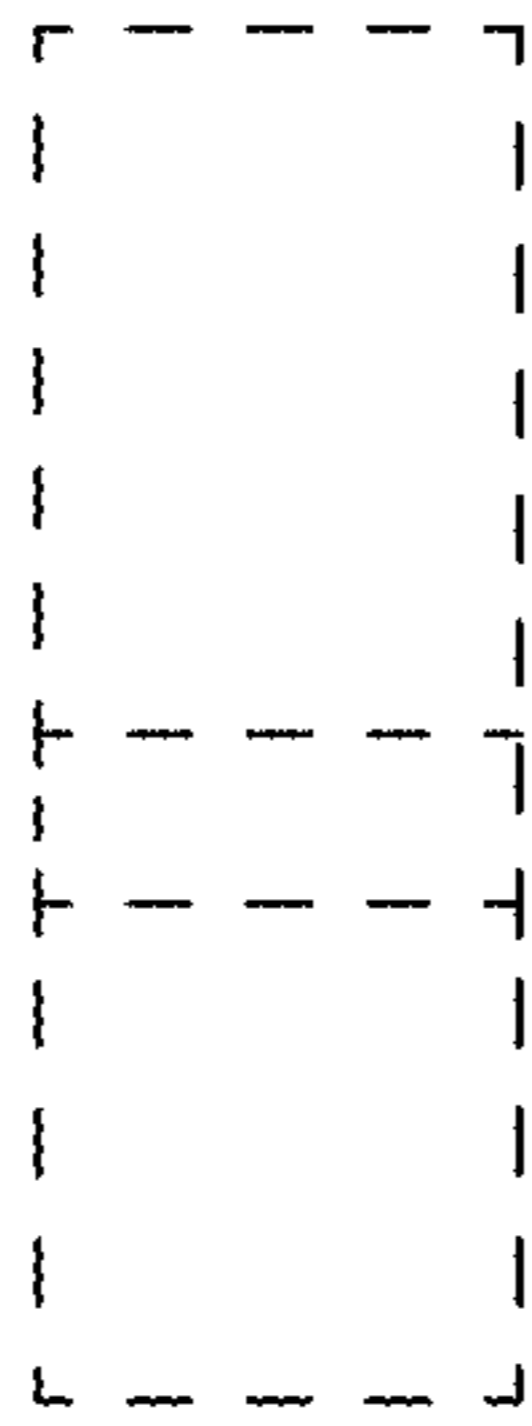

FIG. 6

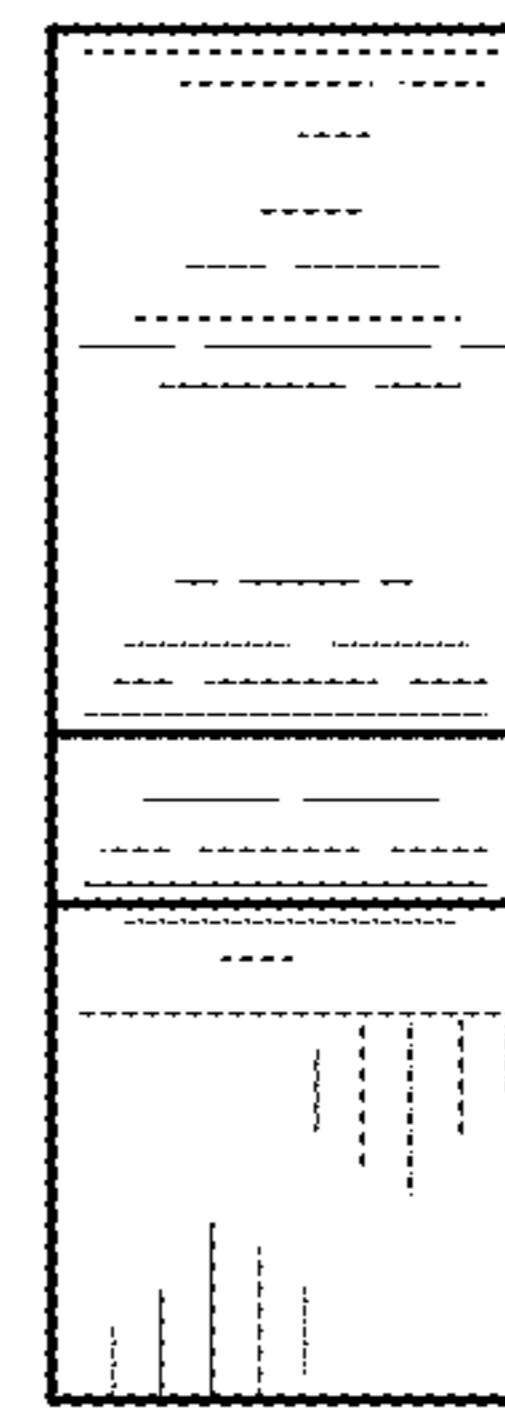

FIG. 7