



US00D865358S

(12) **United States Design Patent** (10) **Patent No.:** **US D865,358 S**
Rahardjo (45) **Date of Patent:** **** Nov. 5, 2019**

(54) **HANDBAG**

D831,346 S * 10/2018 Nair D3/243
D833,739 S * 11/2018 Sassi D3/243

(71) Applicant: **Sri Rahardjo**, Singapore (SG)

* cited by examiner

(72) Inventor: **Sri Rahardjo**, Singapore (SG)

Primary Examiner — Holly H Baynham
(74) *Attorney, Agent, or Firm* — Ziegler IP Law Group, LLC

(**) Term: **15 Years**

(21) Appl. No.: **29/640,049**

(57) **CLAIM**
The ornamental design for a handbag, as shown and described.

(22) Filed: **Mar. 12, 2018**

DESCRIPTION

(51) **LOC (12) Cl.** **03-01**

(52) **U.S. Cl.**
USPC **D3/243**

(58) **Field of Classification Search**
USPC D3/232–233, 240–243, 245–246
CPC A45C 1/024; A45C 3/08
See application file for complete search history.

FIG. 1 is a perspective view of a first embodiment of a handbag showing the new design;
FIG. 2 is a front view thereof;
FIG. 3 is a back view thereof;
FIG. 4 is a side view thereof;
FIG. 5 is another side view thereof, shown from the side opposite that shown in FIG. 4;
FIG. 6 is a top view thereof;
FIG. 7 is a bottom view thereof;
FIG. 8 is a perspective view of a second embodiment of the handbag showing the new design;
FIG. 9 is a front view thereof;
FIG. 10 is a back view thereof;
FIG. 11 is a side view thereof;
FIG. 12 is another side view thereof, shown from the side opposite that shown in FIG. 11;
FIG. 13 is a top view thereof; and,
FIG. 14 is a bottom view thereof.
The broken lines showing stitching are for the purposes of illustrating environment and no part of the claimed design.

(56) **References Cited**

U.S. PATENT DOCUMENTS

- D422,405 S * 4/2000 du Sartel D3/232
- D498,360 S * 11/2004 de Baschmakoff D3/243
- D524,045 S * 7/2006 Handley D3/243
- D661,894 S * 6/2012 Sassi D3/245
- D767,270 S * 9/2016 Maier D3/243
- D767,884 S * 10/2016 Venturini Fendi D3/243
- D792,093 S * 7/2017 Venturini Fendi D3/243
- D794,326 S * 8/2017 Nair D3/243
- D803,555 S * 11/2017 Maier D3/243
- D813,533 S * 3/2018 de Haan D3/243
- D816,330 S * 5/2018 Nair D3/243

1 Claim, 12 Drawing Sheets

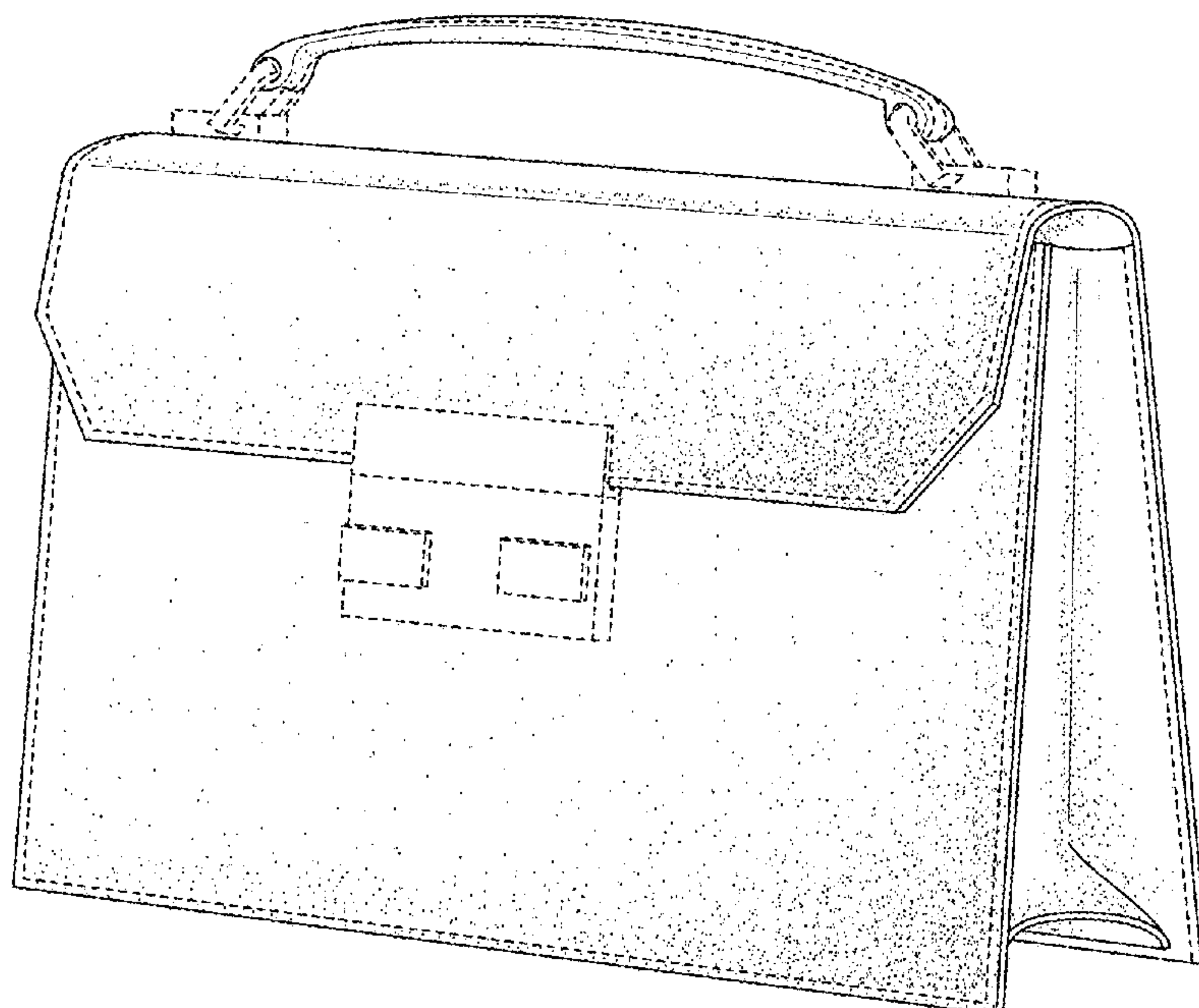

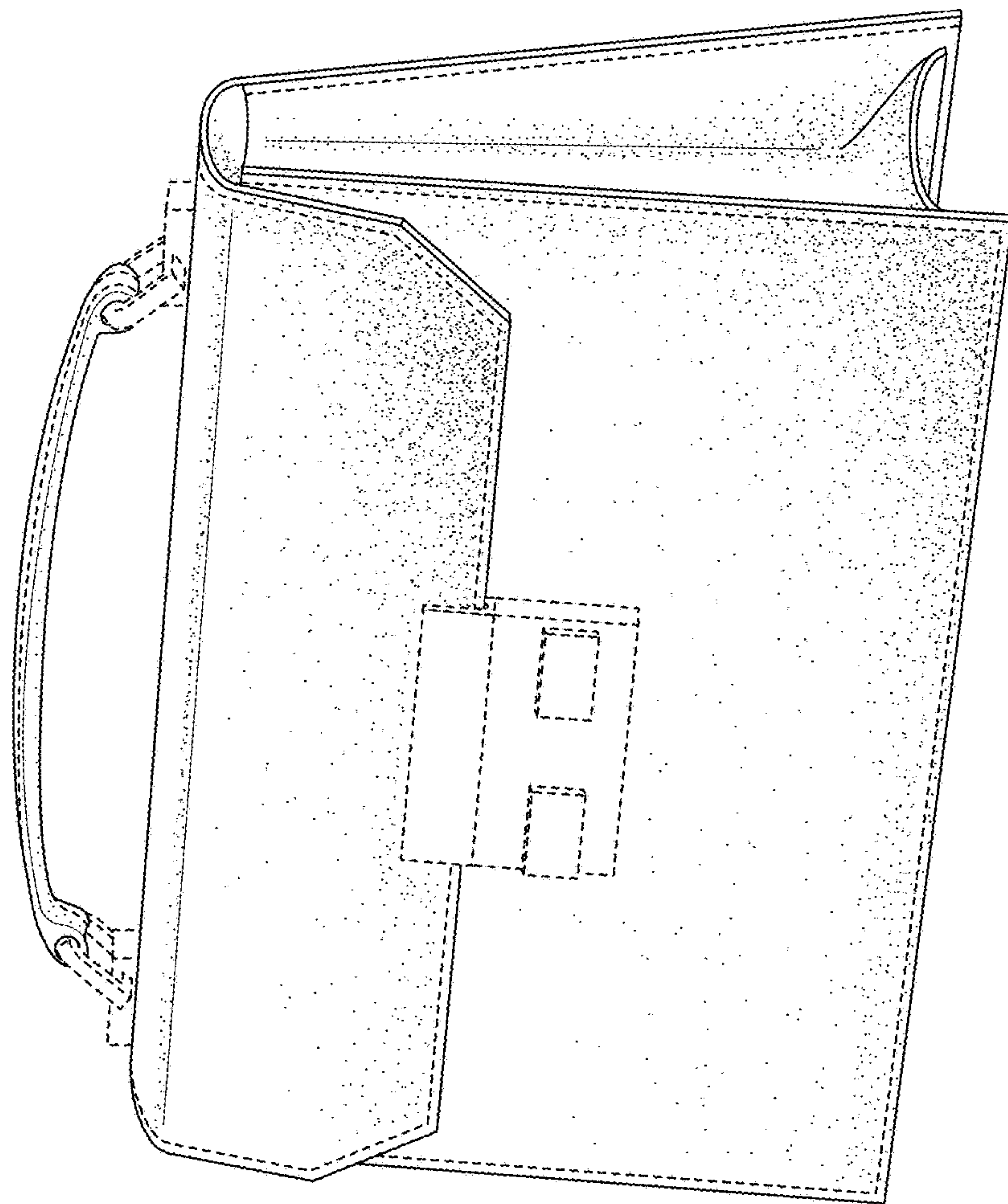

FIG. 1

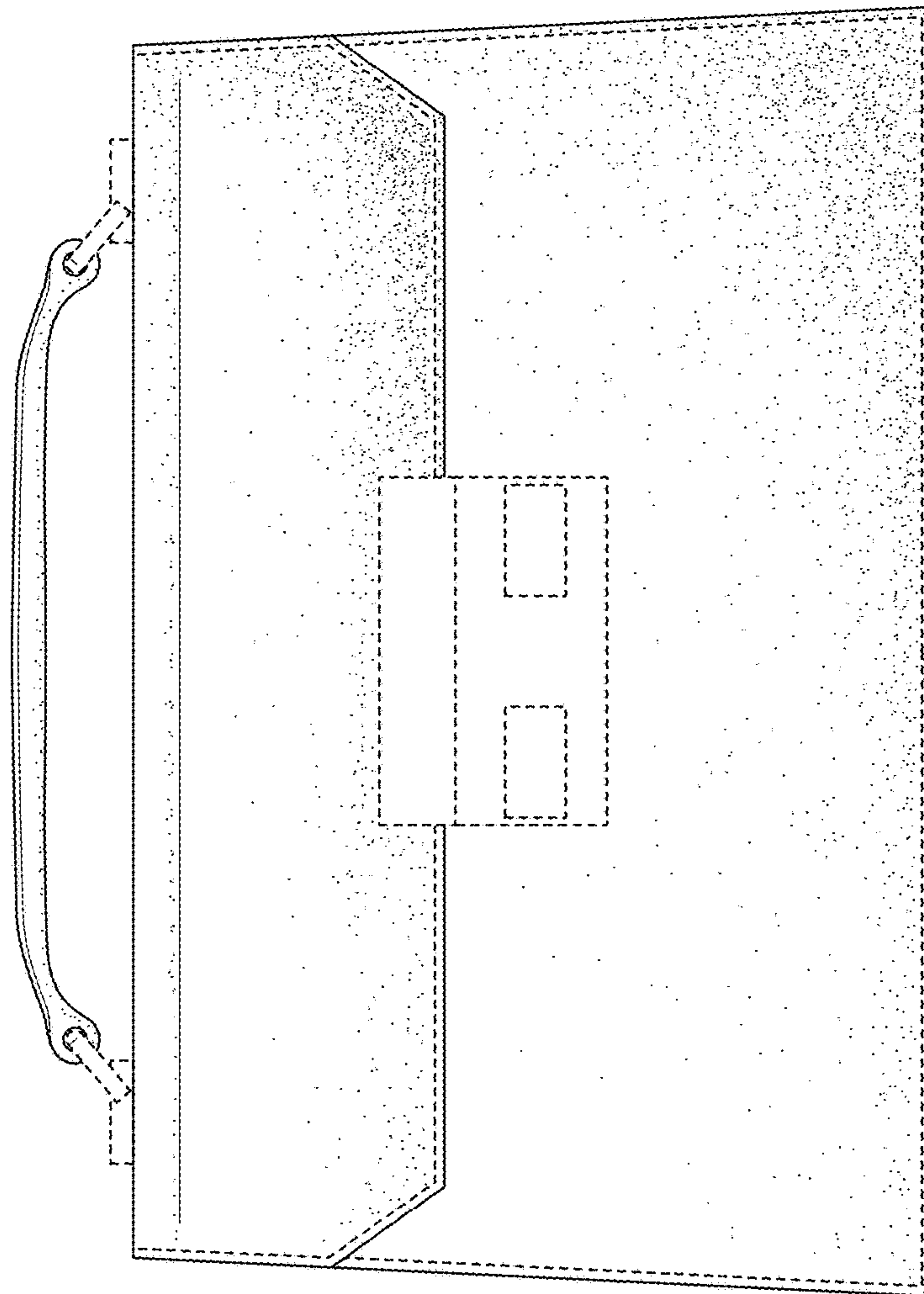

FIG. 2

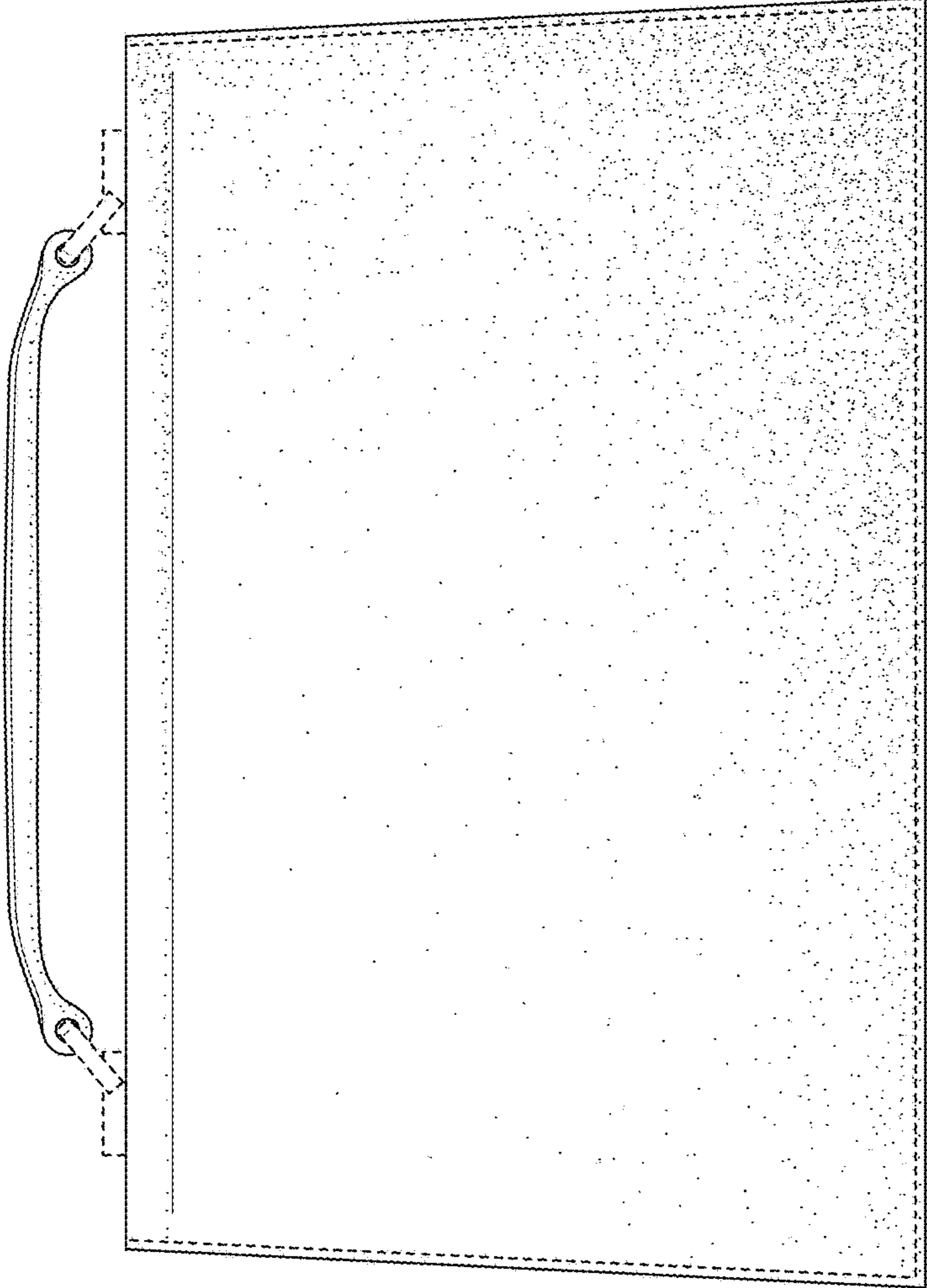

FIG. 3

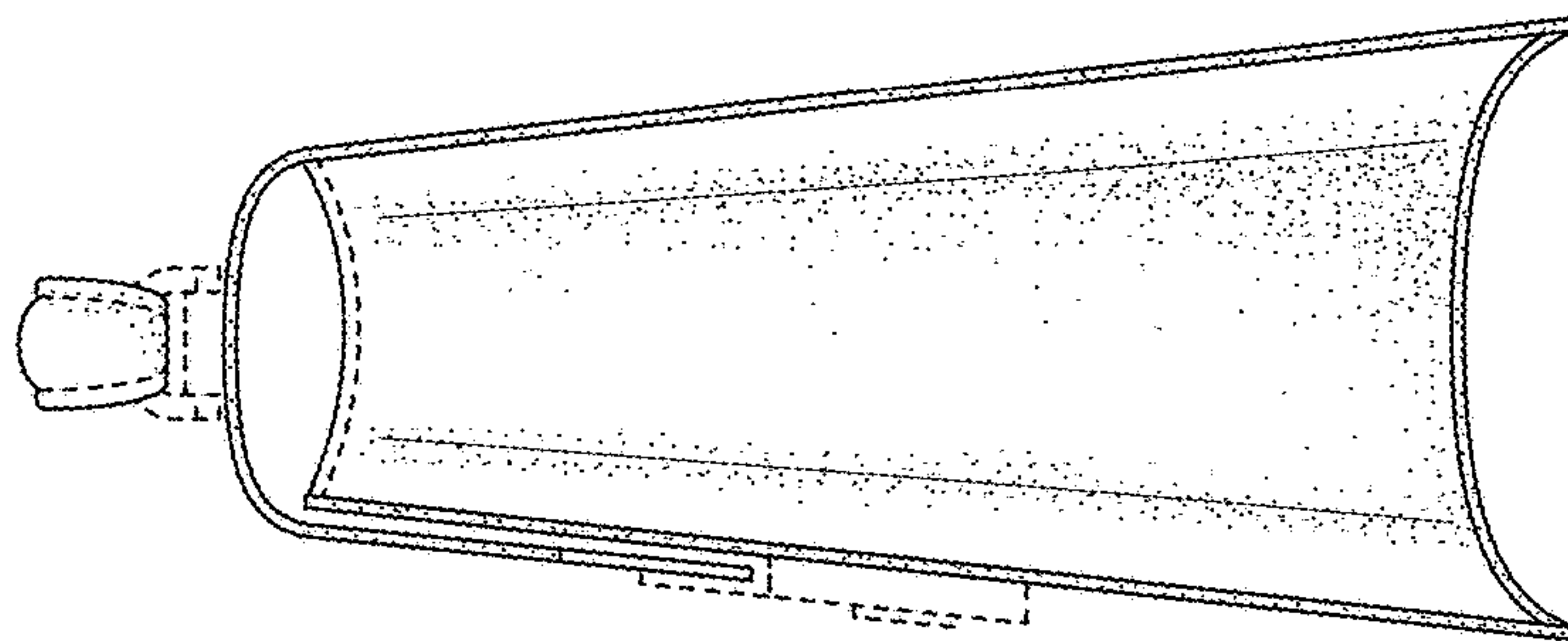

FIG. 5

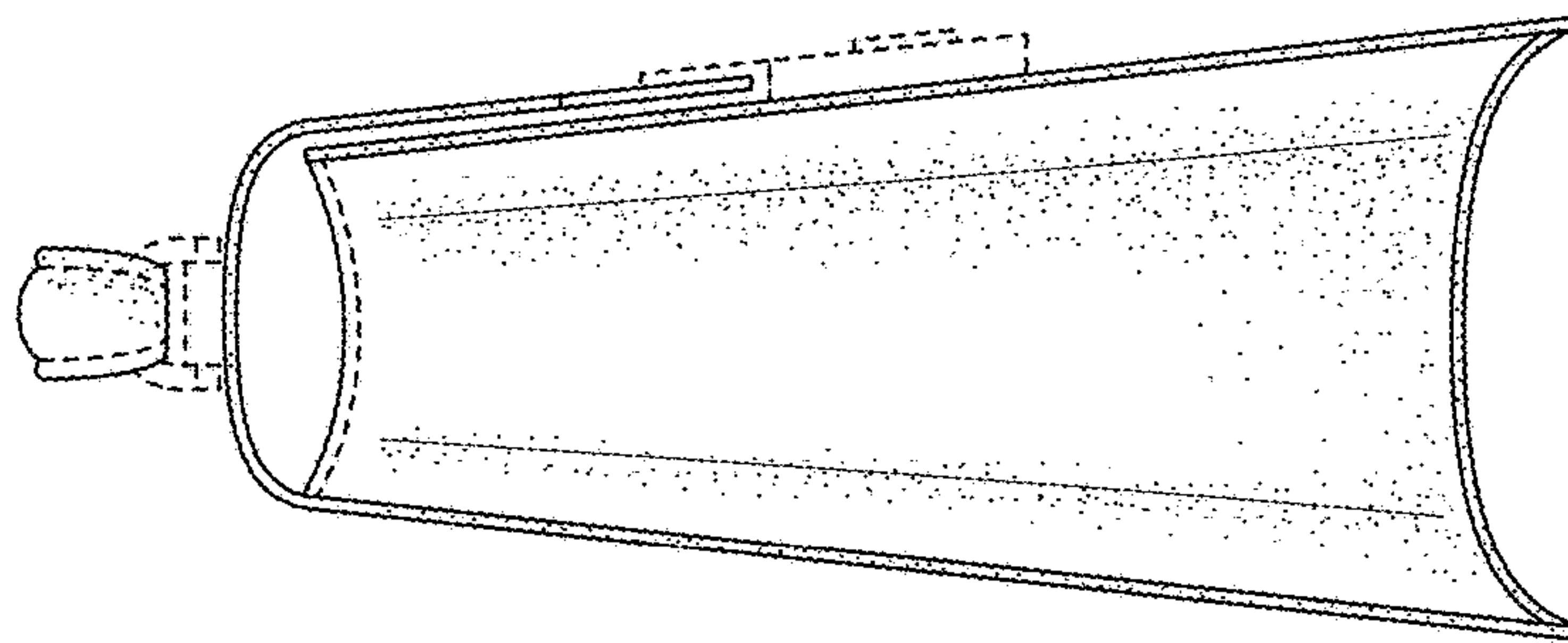

FIG. 4

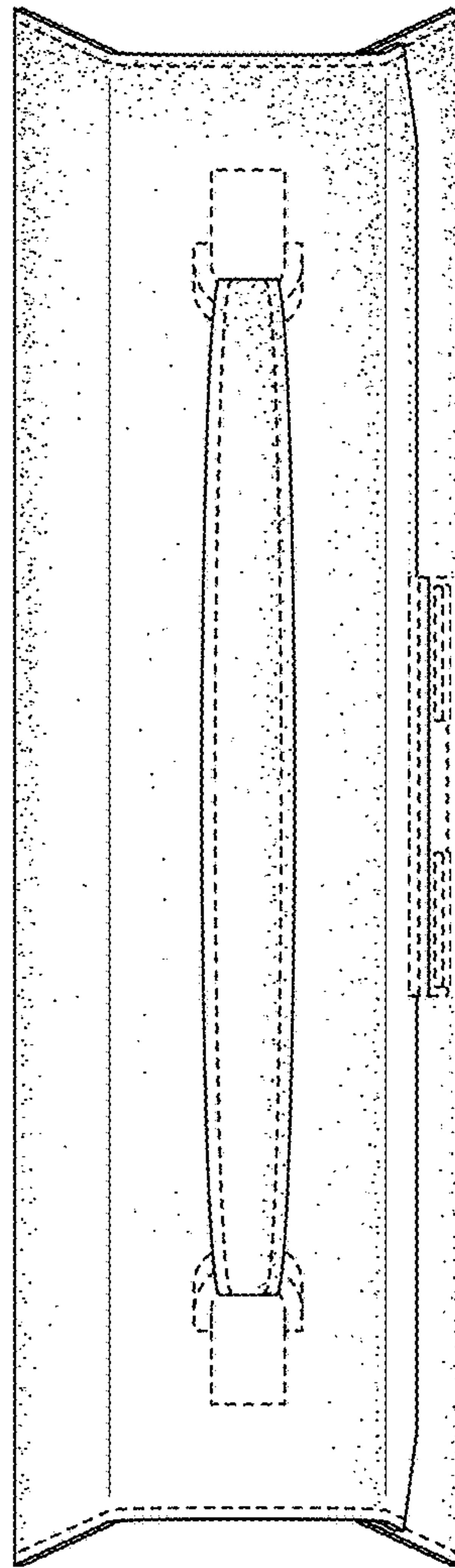

FIG. 6

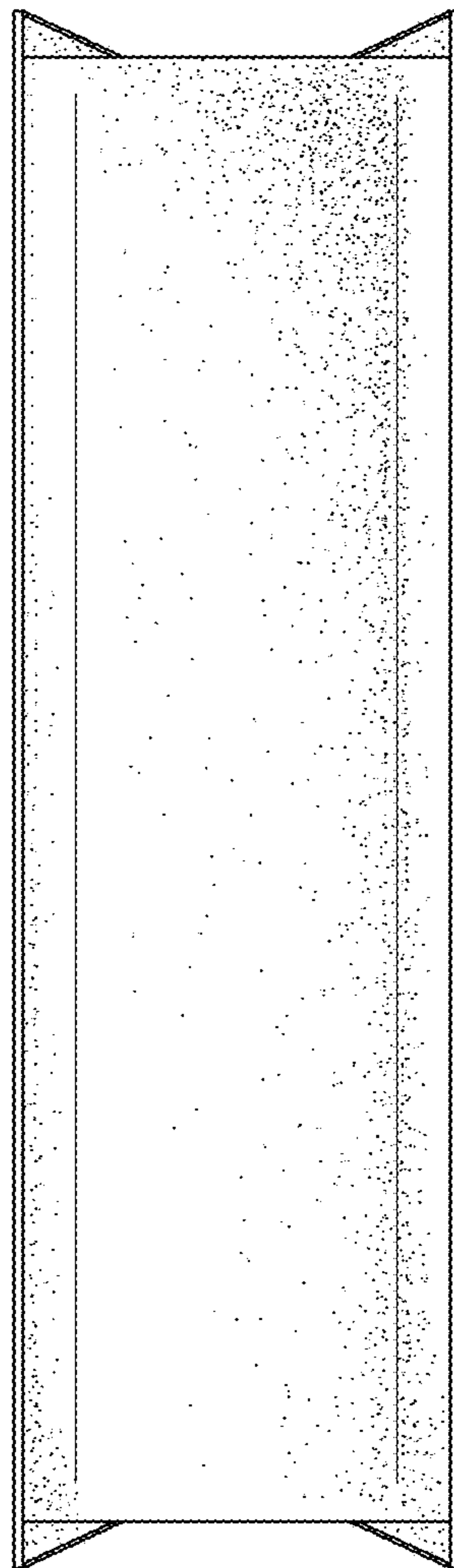

FIG. 7

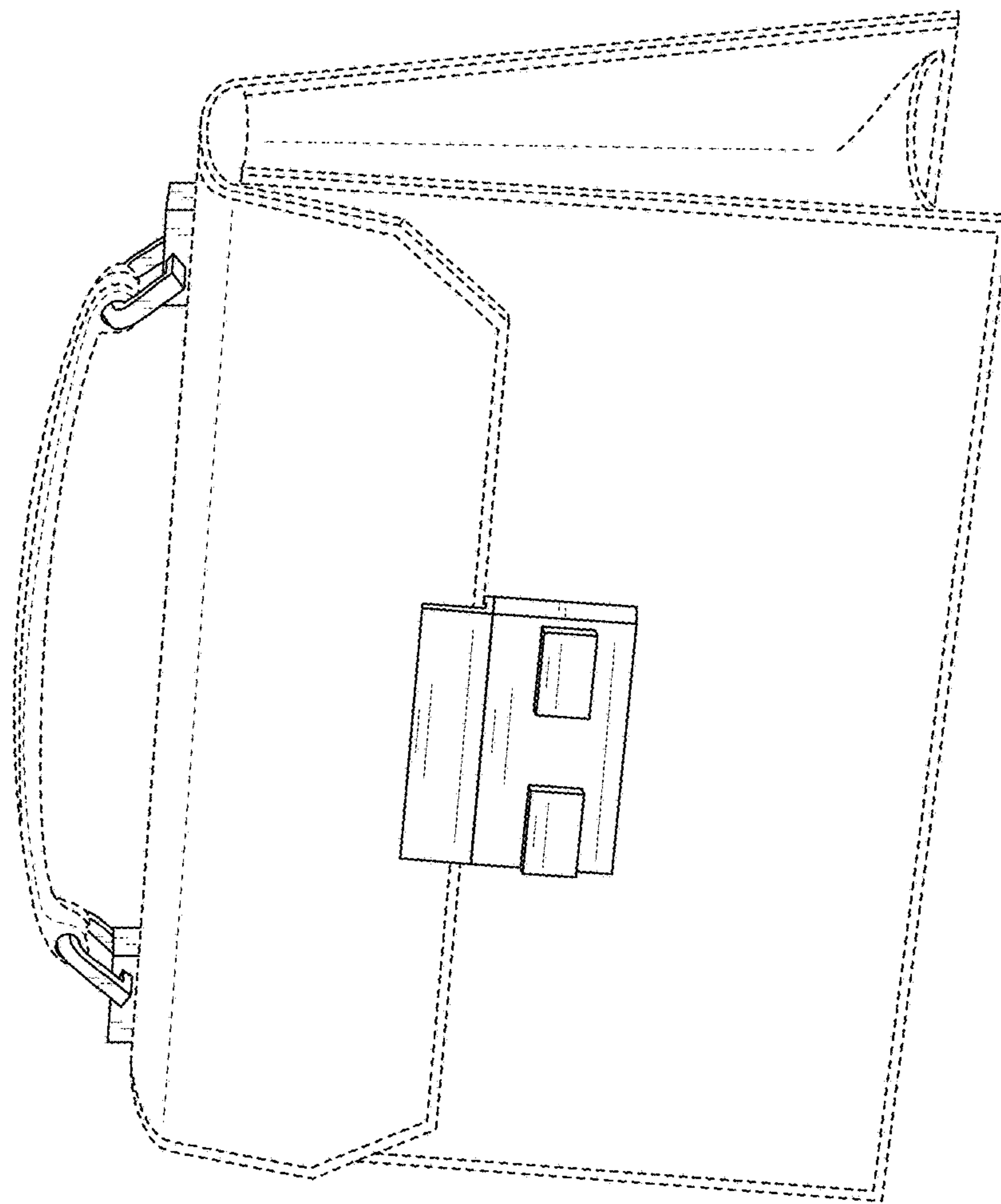

FIG. 8

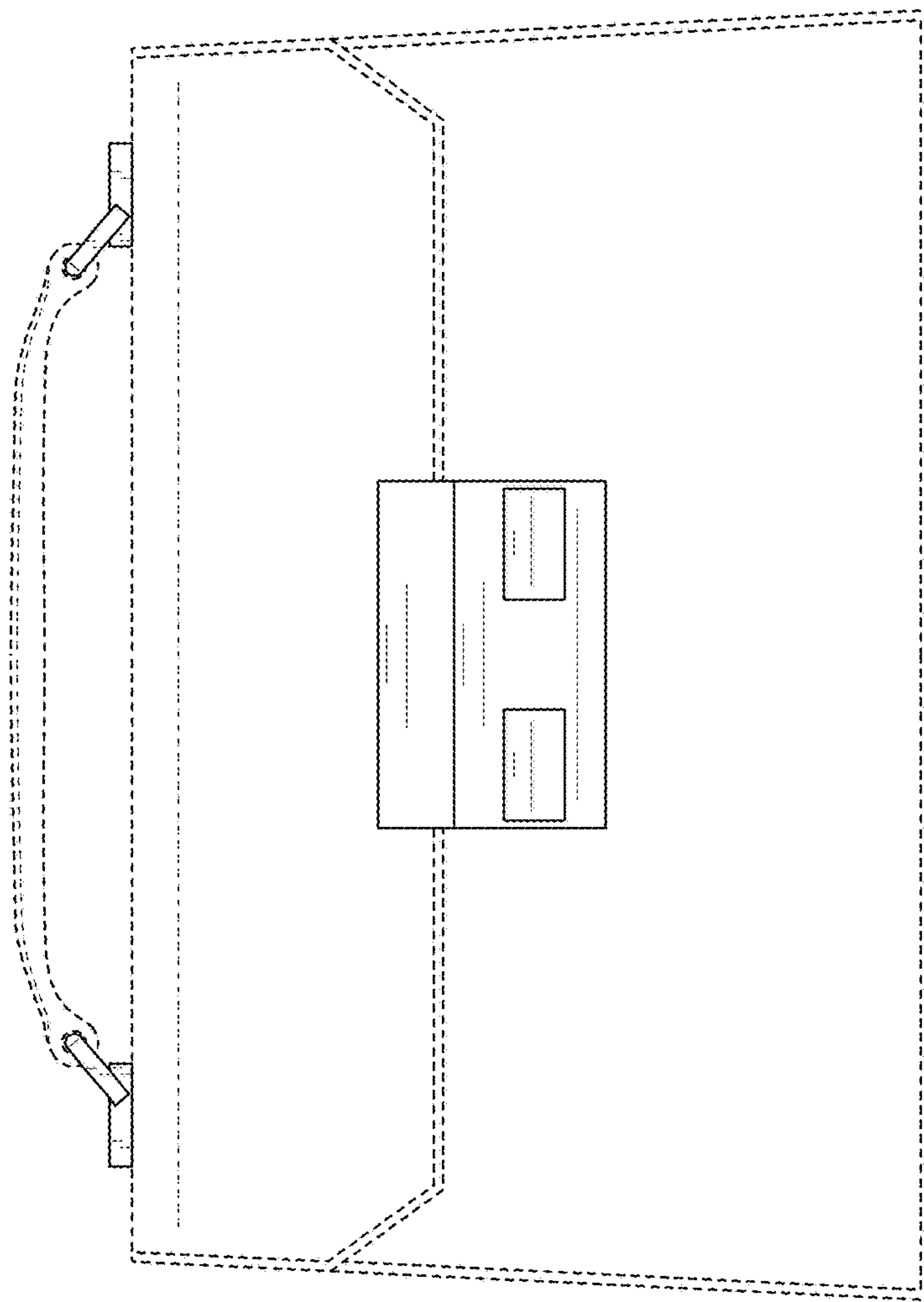

FIG. 9

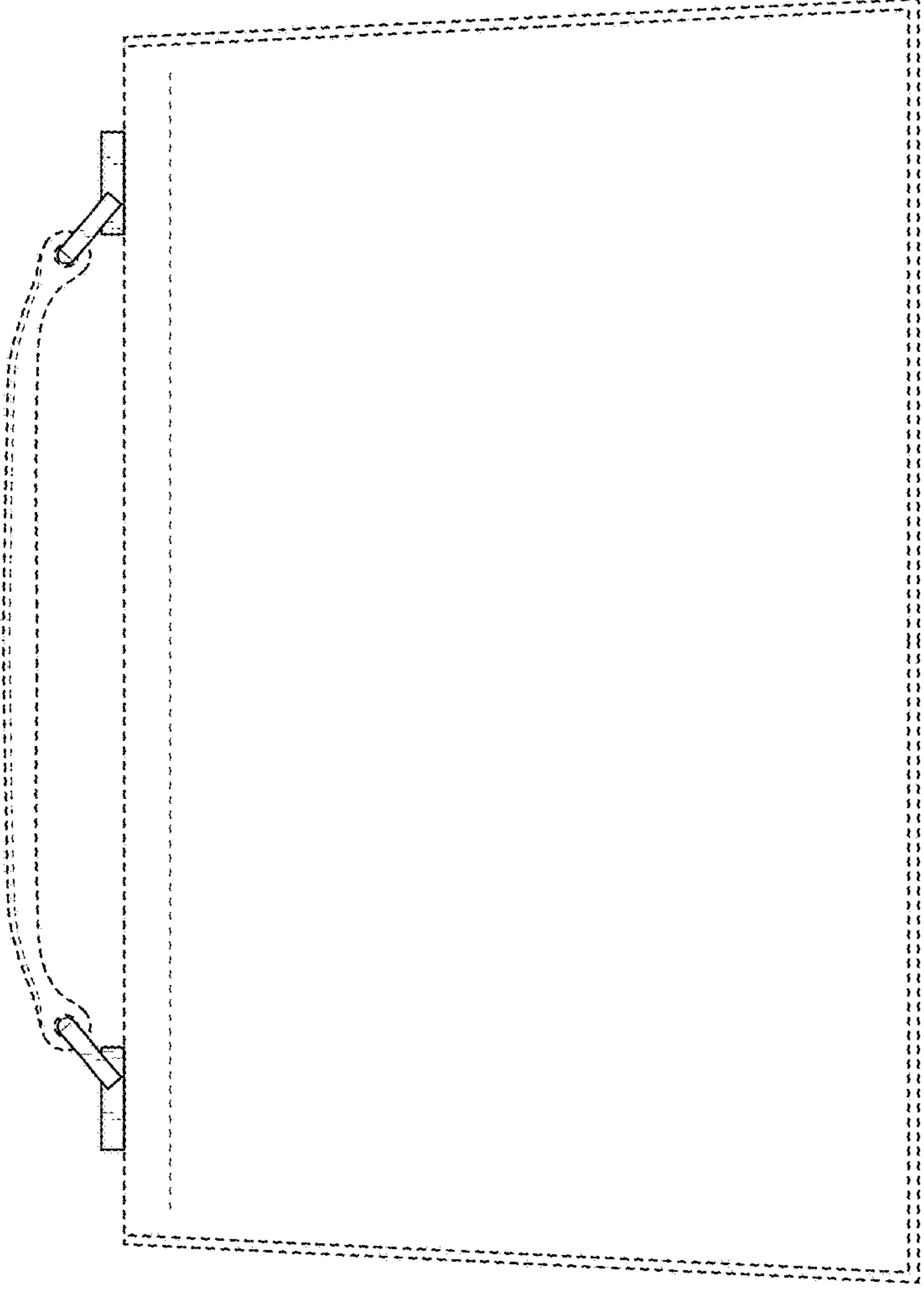

FIG. 10

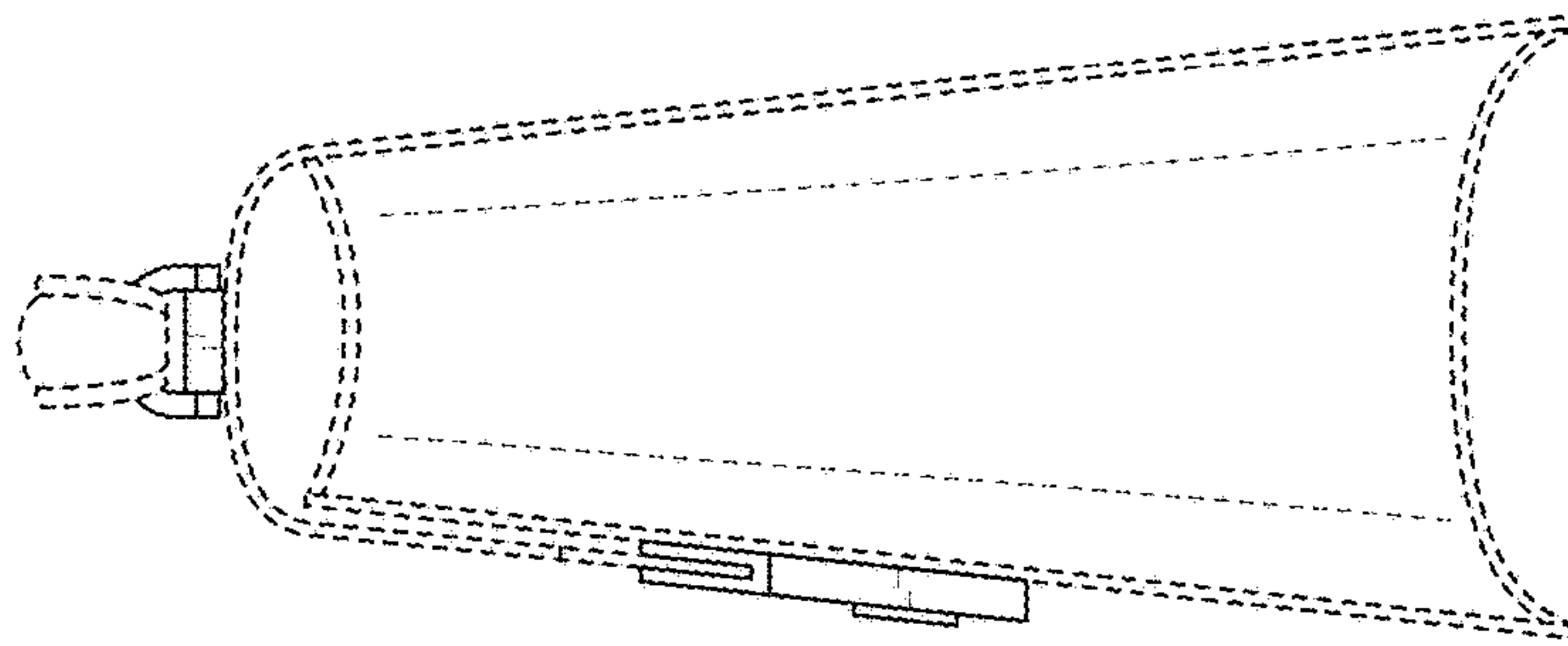

FIG. 12

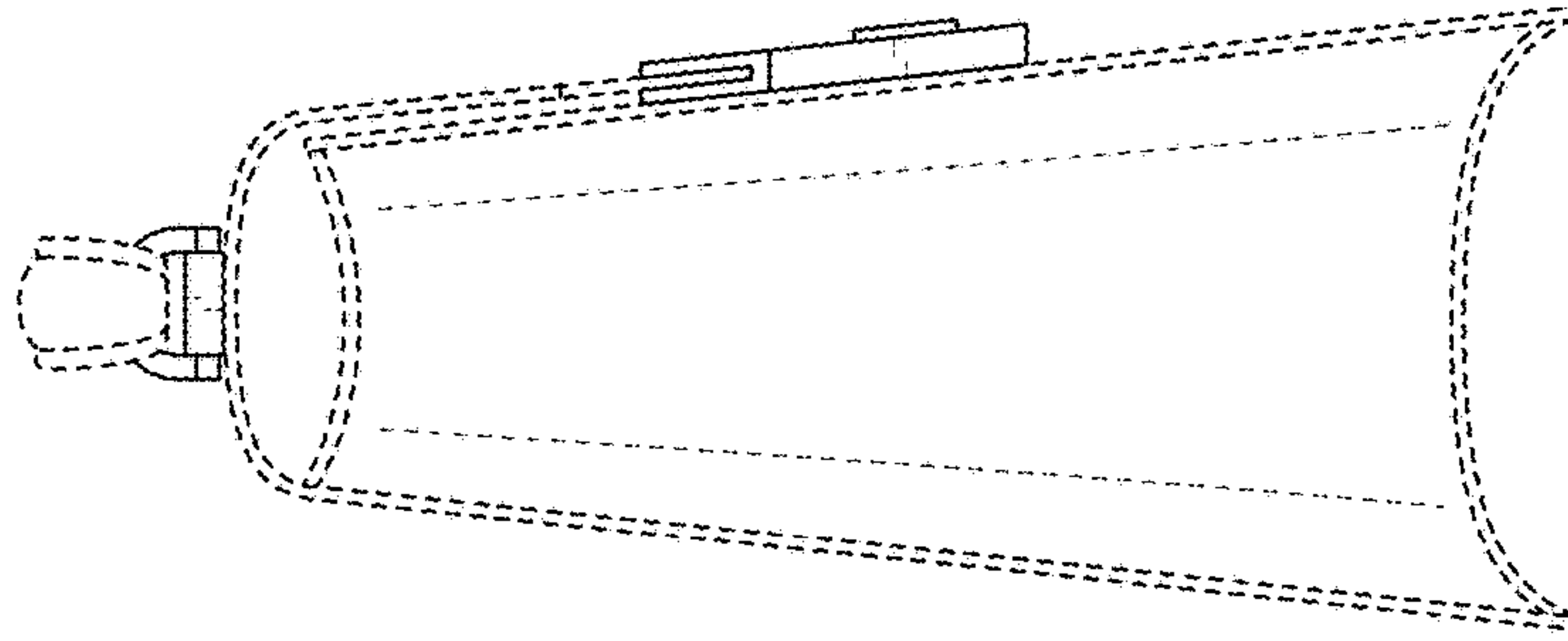

FIG. 11

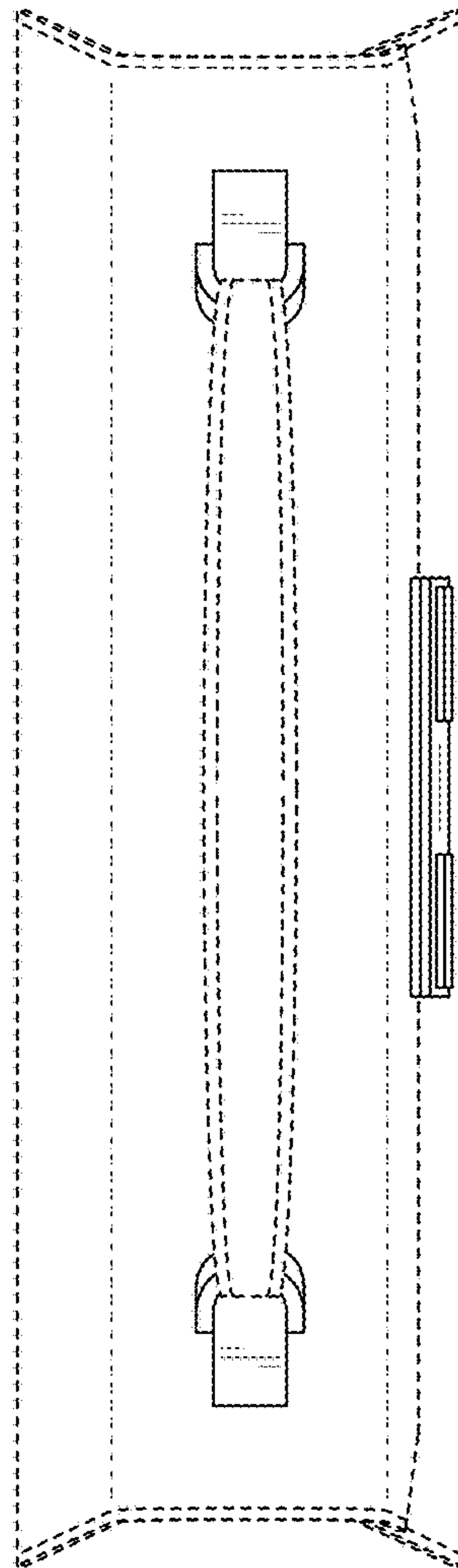

FIG. 13

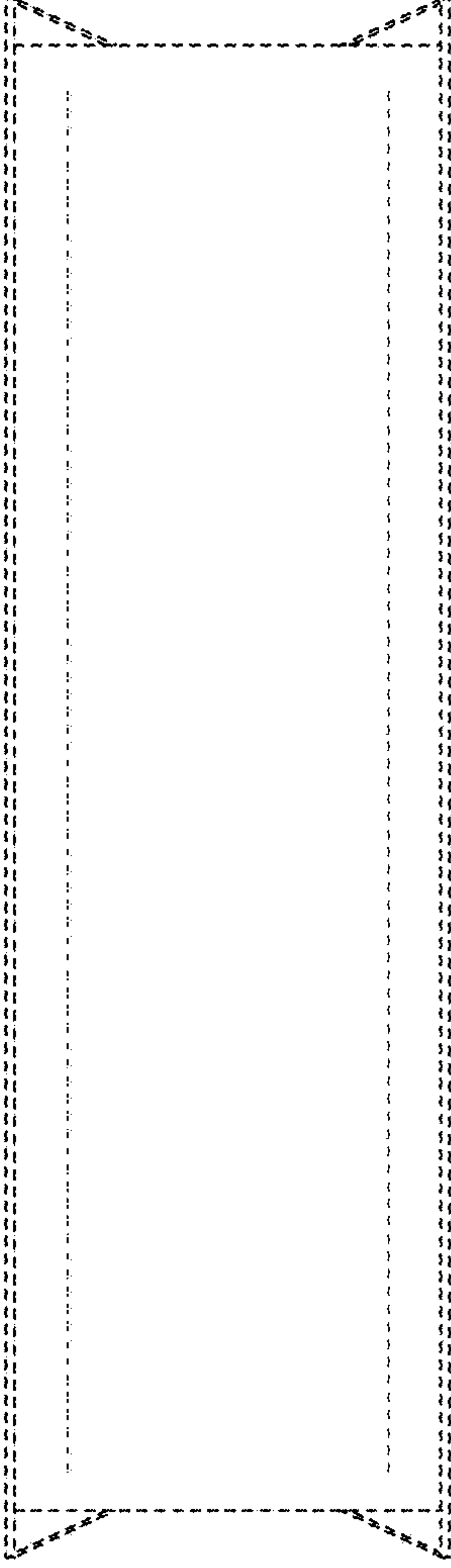

FIG. 14