



US00D865355S

(12) **United States Design Patent**
Benzon et al.

(10) **Patent No.:** **US D865,355 S**

(45) **Date of Patent:** **** Nov. 5, 2019**

(54) **CARRY CASE**

(71) Applicant: **Dell Products L.P.**, Round Rock, TX
(US)

(72) Inventors: **Bruce A. Benzon**, Round Rock, TX
(US); **Chad A. Rabe**, Round Rock, TX
(US)

(73) Assignee: **Dell Products L.P.**, Round Rock, TX
(US)

(**) Term: **15 Years**

(21) Appl. No.: **29/612,137**

(22) Filed: **Jul. 28, 2017**

(51) **LOC (12) Cl.** **03-01**

(52) **U.S. Cl.**

USPC **D3/217**

(58) **Field of Classification Search**

USPC D3/201, 216, 217, 254, 272, 279, 294;
D6/336, 368

CPC A45F 3/04; A45F 4/02; A45F 2003/045;
A45F 2003/125; A45F 3/02; A45F
2003/127; A45F 3/047; A45F 3/12; A45F
2003/001

See application file for complete search history.

(56) **References Cited**

U.S. PATENT DOCUMENTS

D699,431 S *	2/2014	Hock	D3/216
D699,942 S *	2/2014	Mather	D3/216
D699,944 S *	2/2014	Mather	D3/216
D758,715 S *	6/2016	Daniel	D3/217
D802,295 S *	11/2017	Wu	D3/217
D829,436 S *	10/2018	Benzon	D3/217
D843,714 S *	3/2019	Sheikh	D3/217
2002/0139820 A1 *	10/2002	Godshaw	A45F 3/04 224/153

2009/0201671 A1* 8/2009 Huntley A01K 27/006
362/108

2010/0140307 A1* 6/2010 Almoumen A45F 3/04
224/155

2012/0048904 A1* 3/2012 Scicluna A45C 13/30
224/627

OTHER PUBLICATIONS

U.S. Appl. No. 29/580,521, filed Oct. 11, 2016, entitled Backpack,
to inventors Bruce A. Benzon et al.

Incase, "Backpacks," downloaded from <https://www.incase.com/products/bags/backpacks>, Jun. 15, 2018, 14 pages.

* cited by examiner

Primary Examiner — Jennifer L Watkins

(74) *Attorney, Agent, or Firm* — Zagorin Cave LLP;
Robert W. Holland

(57) **CLAIM**

We claim the ornamental design for a carry case, as shown
and described.

DESCRIPTION

FIG. 1 is a front perspective view of a carry case comprising
the present invention;

FIG. 2 is a front elevation view thereof;

FIG. 3 is a rear elevation view thereof;

FIG. 4 is a right side view thereof;

FIG. 5 is a left side view thereof;

FIG. 6 is a top view thereof;

FIG. 7 is a bottom view thereof; and,

FIG. 8 is a rear perspective view thereof.

Broken lines shown in the drawings illustrate portions of the
carry case, and form no part of the claimed design.

1 Claim, 7 Drawing Sheets

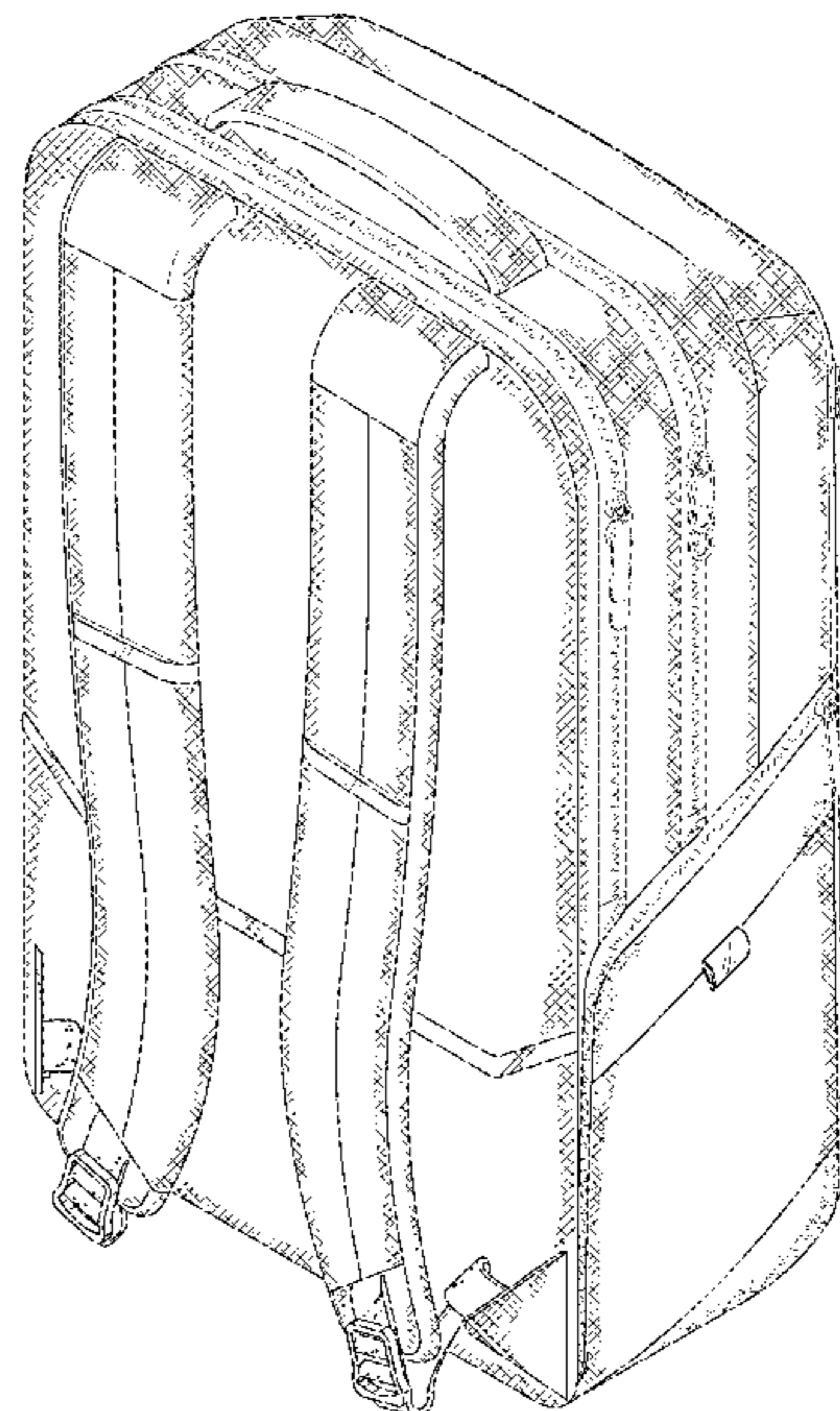
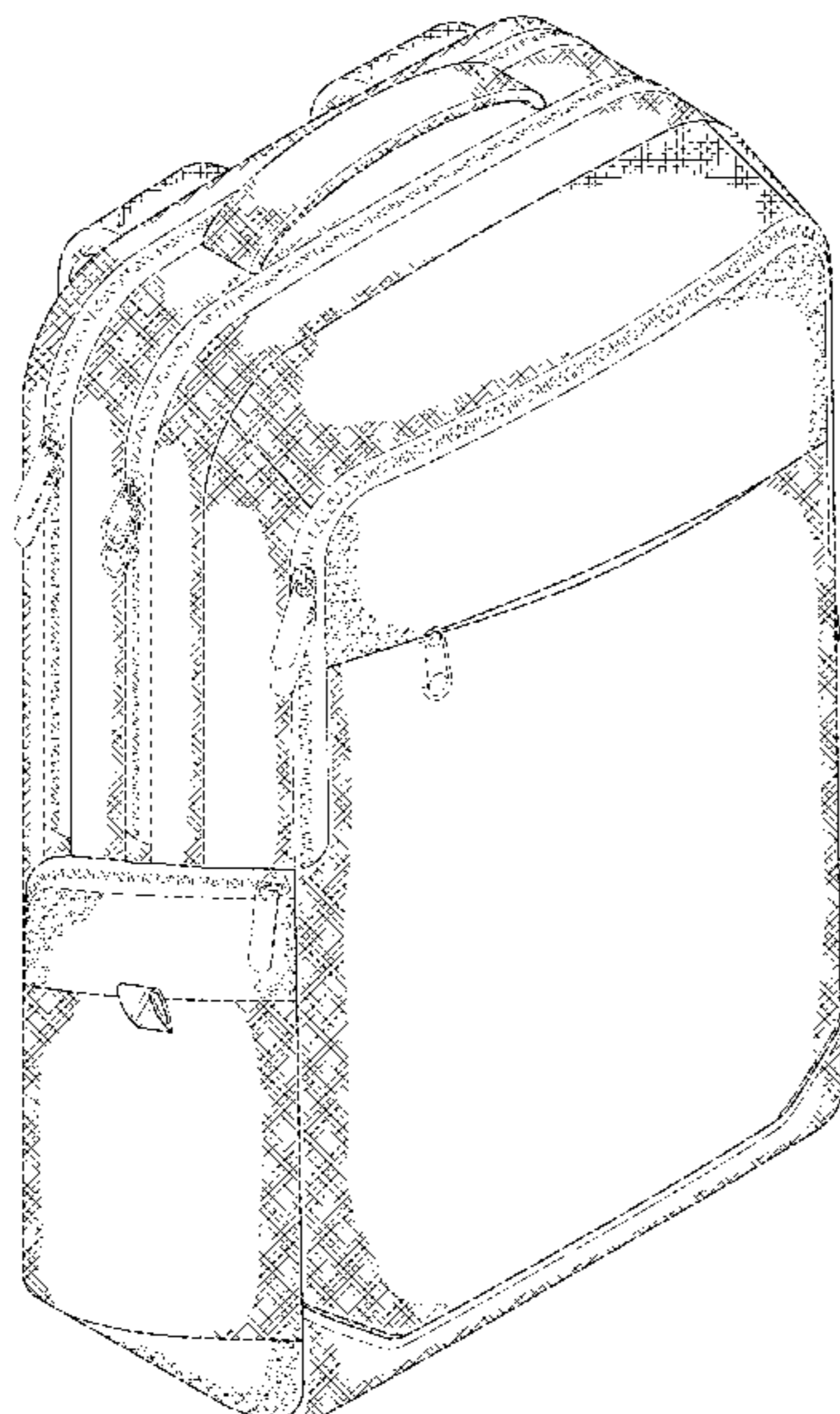

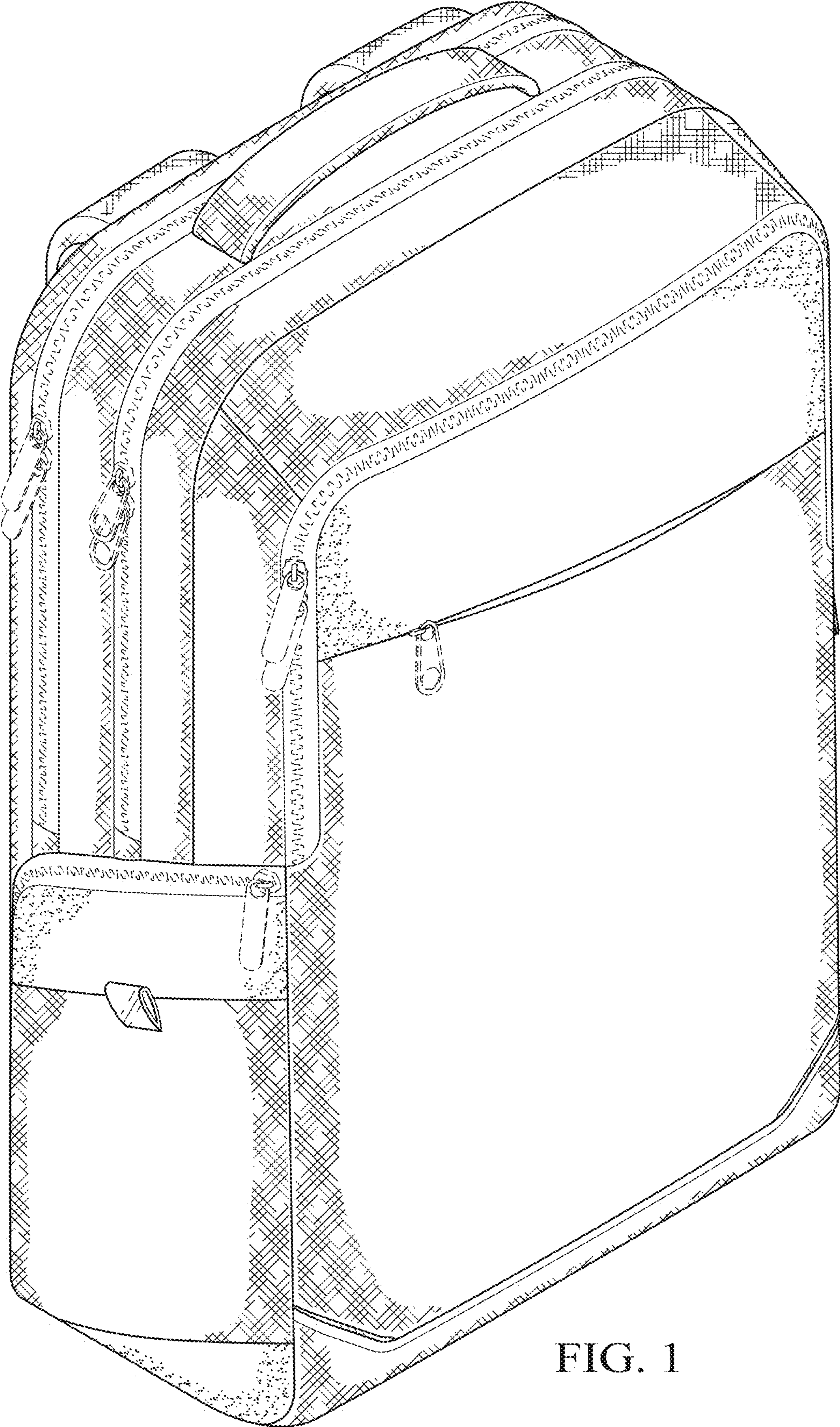

FIG. 1

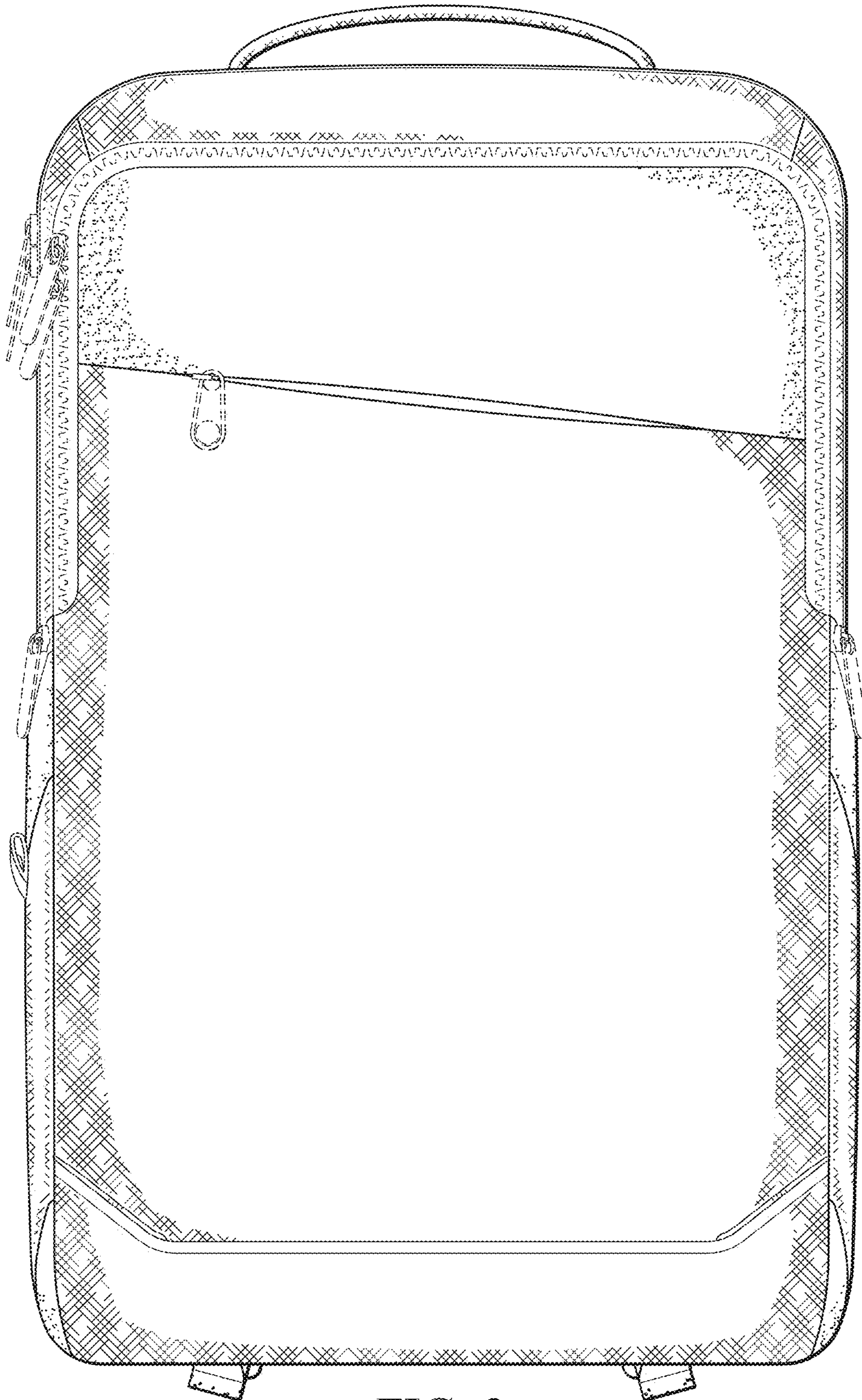

FIG. 2

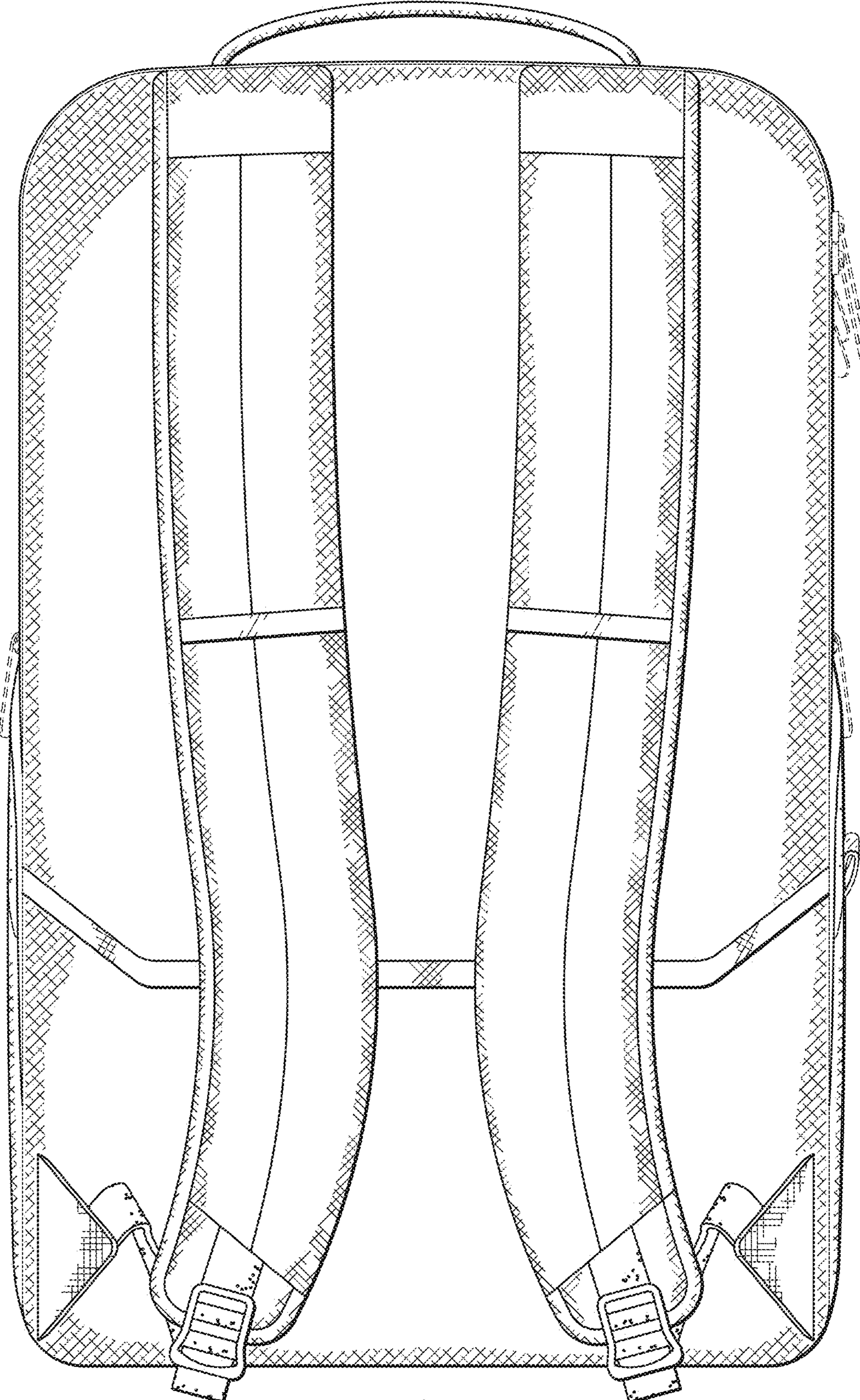

FIG. 3

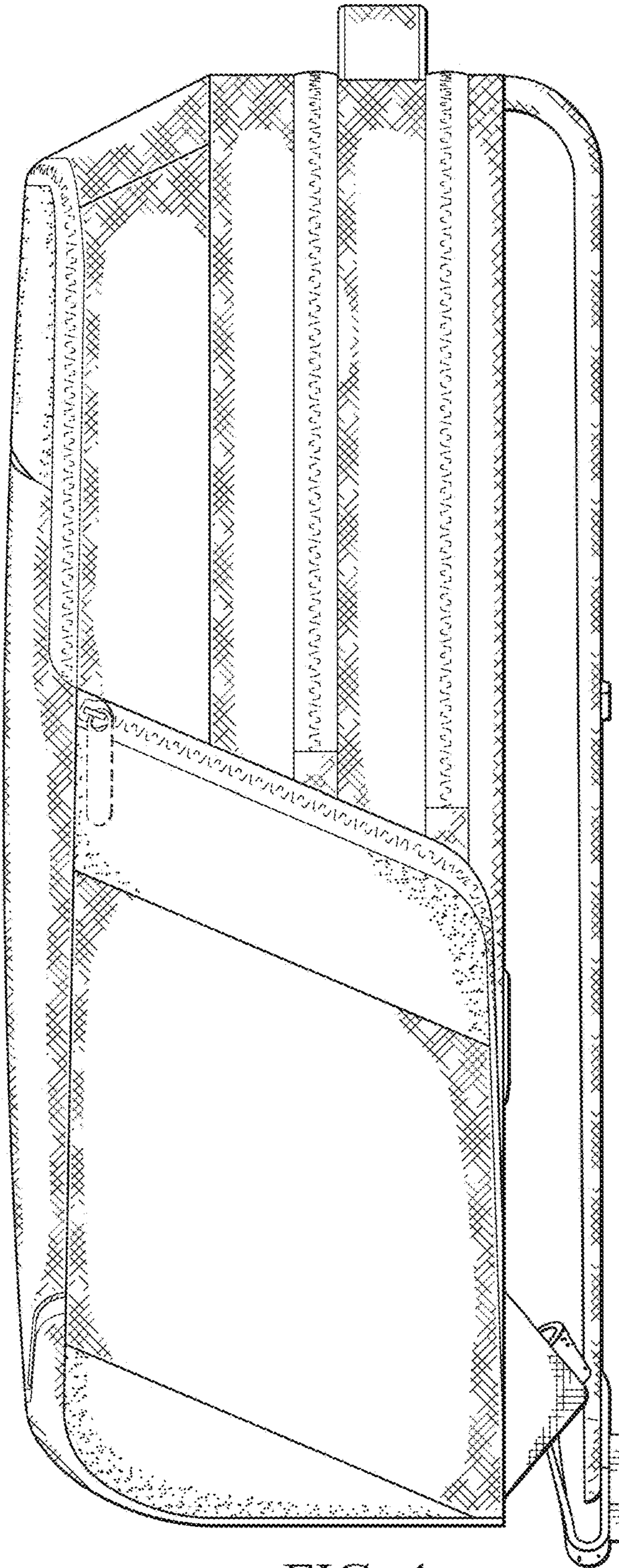

FIG. 4

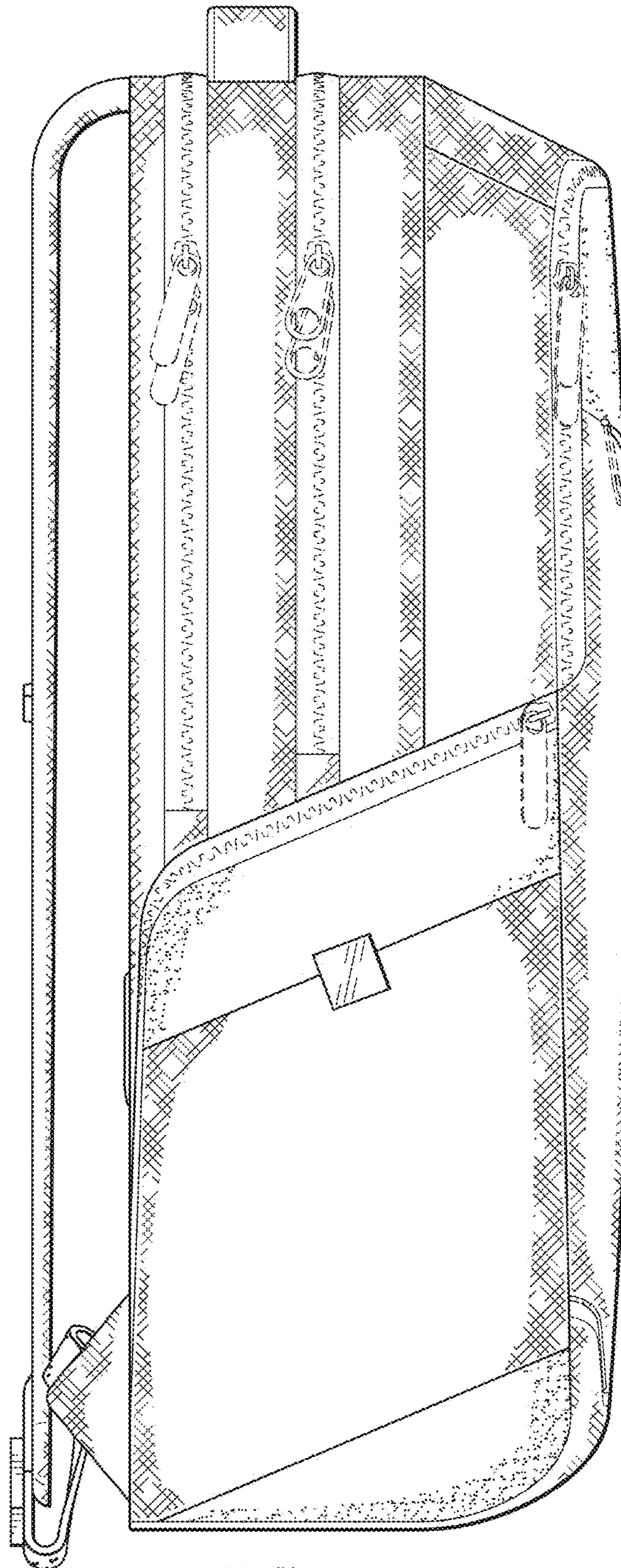

FIG. 5

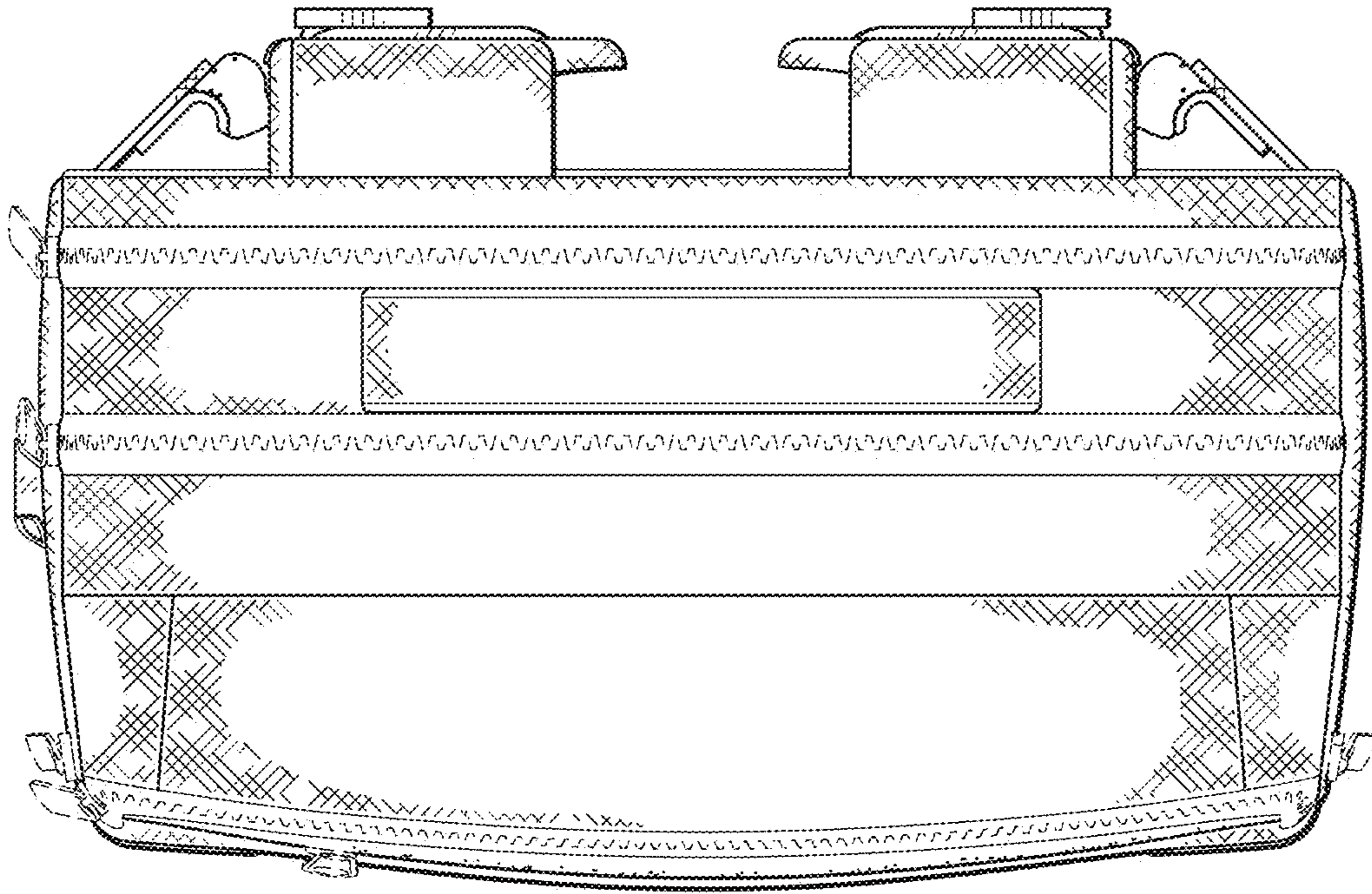

FIG. 6

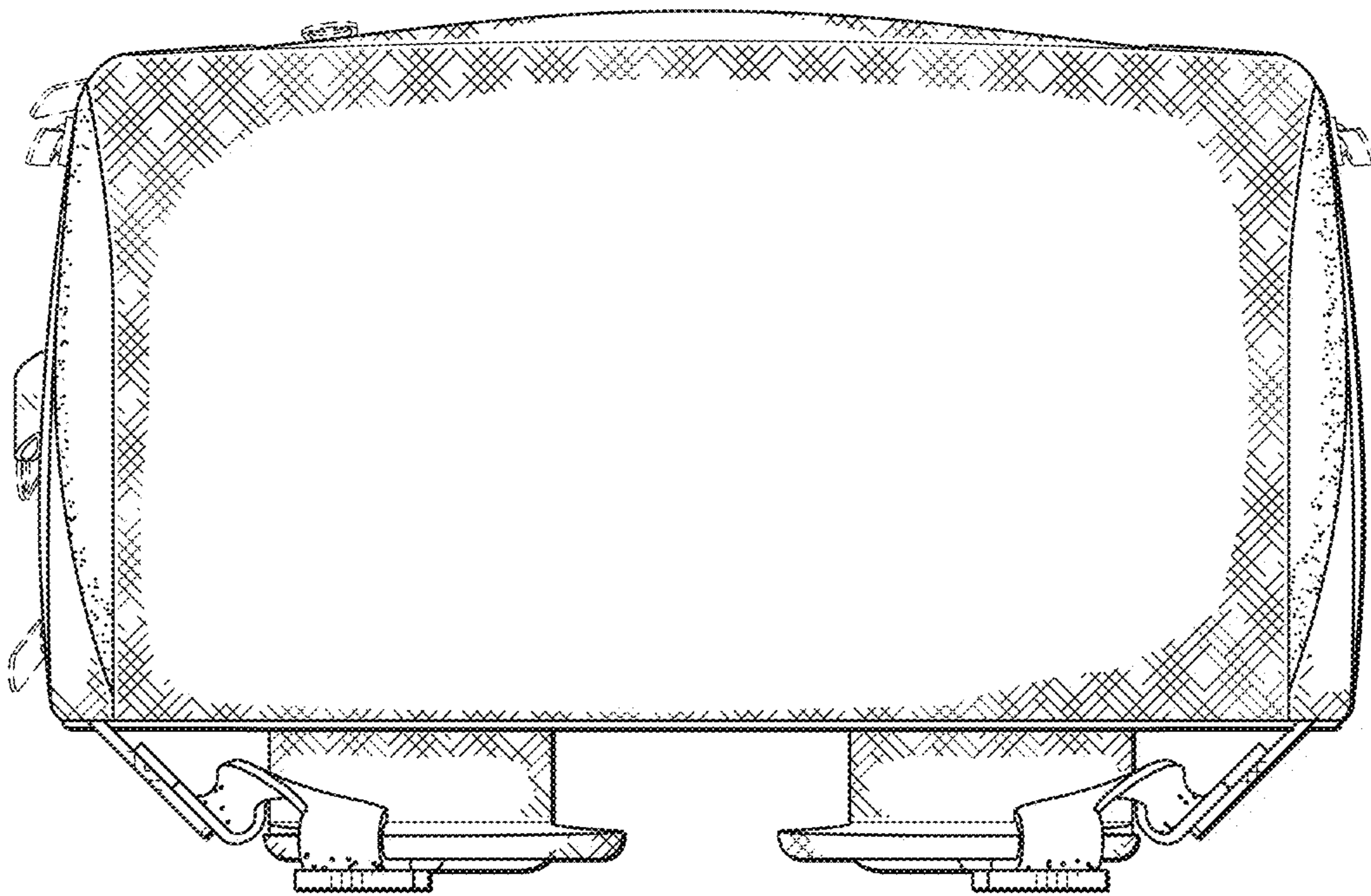

FIG. 7

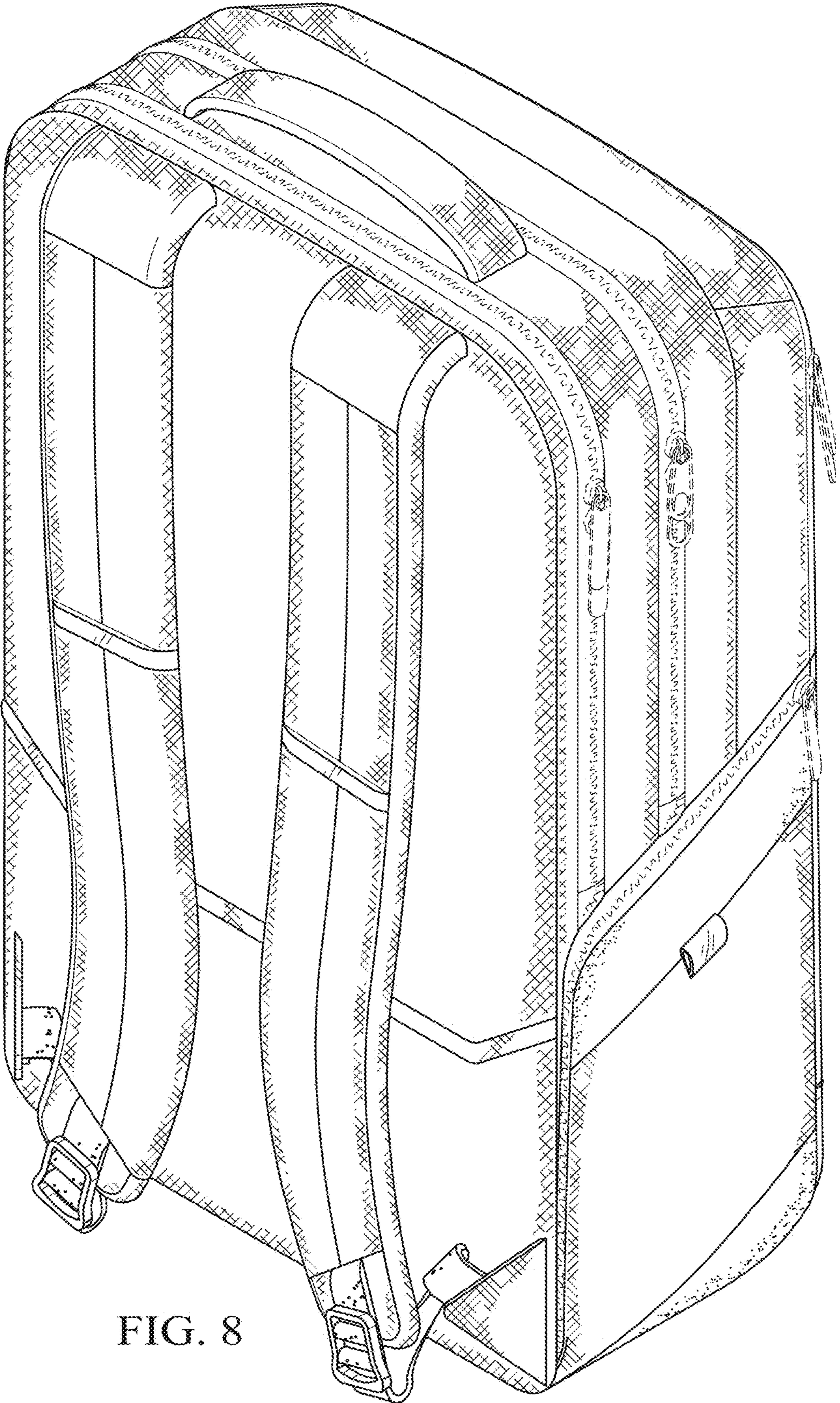

FIG. 8