



US00D865292S

(12) **United States Design Patent**
Peterson, Jr.

(10) **Patent No.:** **US D865,292 S**
(45) **Date of Patent:** **** Oct. 29, 2019**

(54) **COMBINED HAIR CLIPPER AND STAND**

- (71) Applicant: **ANDIS COMPANY**, Sturtevant, WI (US)
- (72) Inventor: **John H. Peterson, Jr.**, Oak Creek, WI (US)
- (73) Assignee: **Andis Company**, Sturtevant, WI (US)
- (**) Term: **15 Years**
- (21) Appl. No.: **29/641,230**
- (22) Filed: **Mar. 20, 2018**
- (51) **LOC (12) Cl.** **28-03**
- (52) **U.S. Cl.**
USPC **D28/53; D28/73**
- (58) **Field of Classification Search**
USPC **D28/49-54, 73**
(Continued)

(56) **References Cited**

U.S. PATENT DOCUMENTS

- D360,485 S * 7/1995 Simonelli D28/73
 - D513,346 S * 12/2005 Buck, Jr. D28/73
- (Continued)

Primary Examiner — Jennifer Rivard

(74) *Attorney, Agent, or Firm* — Reinhart Boerner Van Deuren s.c.

(57) **CLAIM**

I claim the ornamental design for a combined hair clipper and stand, as shown and described.

DESCRIPTION

FIG. 1 is a perspective view of a hair clipper according to an embodiment showing the new design;

FIG. 2 is a top view of the hair clipper shown in FIG. 1; FIG. 3 is a bottom view of the hair clipper shown in FIG. 1; FIG. 4 is an elevation view of a first side of the hair clipper shown in FIG. 1; FIG. 5 is an elevation view of a second side of the hair clipper shown in FIG. 1; FIG. 6 is an elevation view of a first end of the hair clipper shown in FIG. 1; FIG. 7 is an elevation view of a second end of the hair clipper shown in FIG. 1; FIG. 8 is a perspective view of a hair clipper according to another embodiment showing the new design; FIG. 9 is a top view of the hair clipper shown in FIG. 8; FIG. 10 is a bottom view of the hair clipper shown in FIG. 8; FIG. 11 is an elevation view of a first side of the hair clipper shown in FIG. 8; FIG. 12 is an elevation view of a second side of the hair clipper shown in FIG. 8; FIG. 13 is an elevation view of a first end of the hair clipper shown in FIG. 8; FIG. 14 is an elevation view of a second end of the hair clipper shown in FIG. 8; FIG. 15 is a perspective view of a stand for the hair clipper shown in FIGS. 1 and 8; FIG. 16 is an elevation view of a first end of the stand shown in FIG. 15; FIG. 17 is an elevation view of a second end of the stand shown in FIG. 15; FIG. 18 is an elevation view of a first side of the stand shown in FIG. 15; FIG. 19 is an elevation view of a second side of the stand shown in FIG. 15; FIG. 20 is a top view of the stand shown in FIG. 15; and, FIG. 21 is a bottom view of the stand shown in FIG. 15. The present application is directed to the design illustrated in the figures. The broken lines shown in the drawings illustrate portions of the hair clipper and form no part of the claimed design.

1 Claim, 18 Drawing Sheets

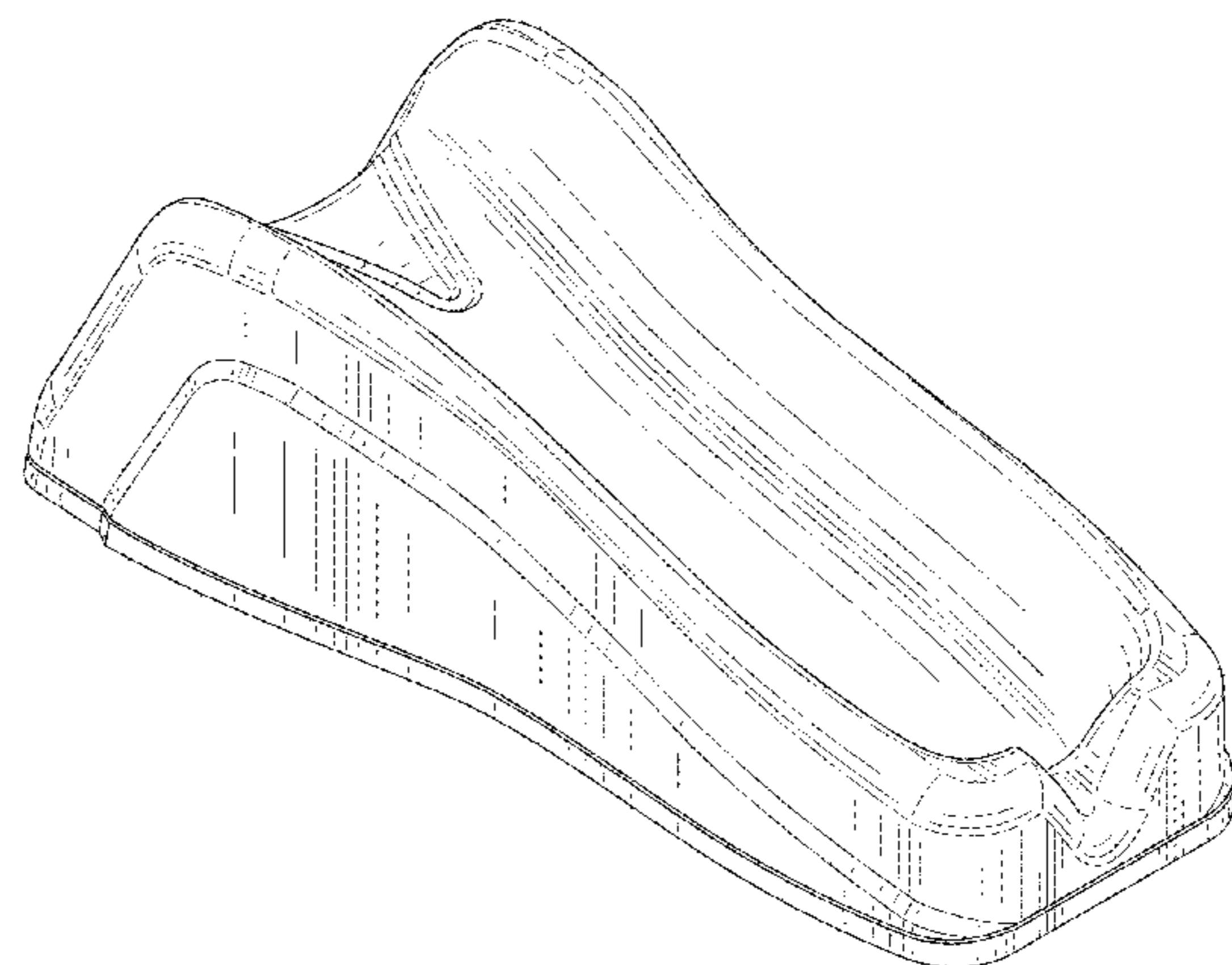
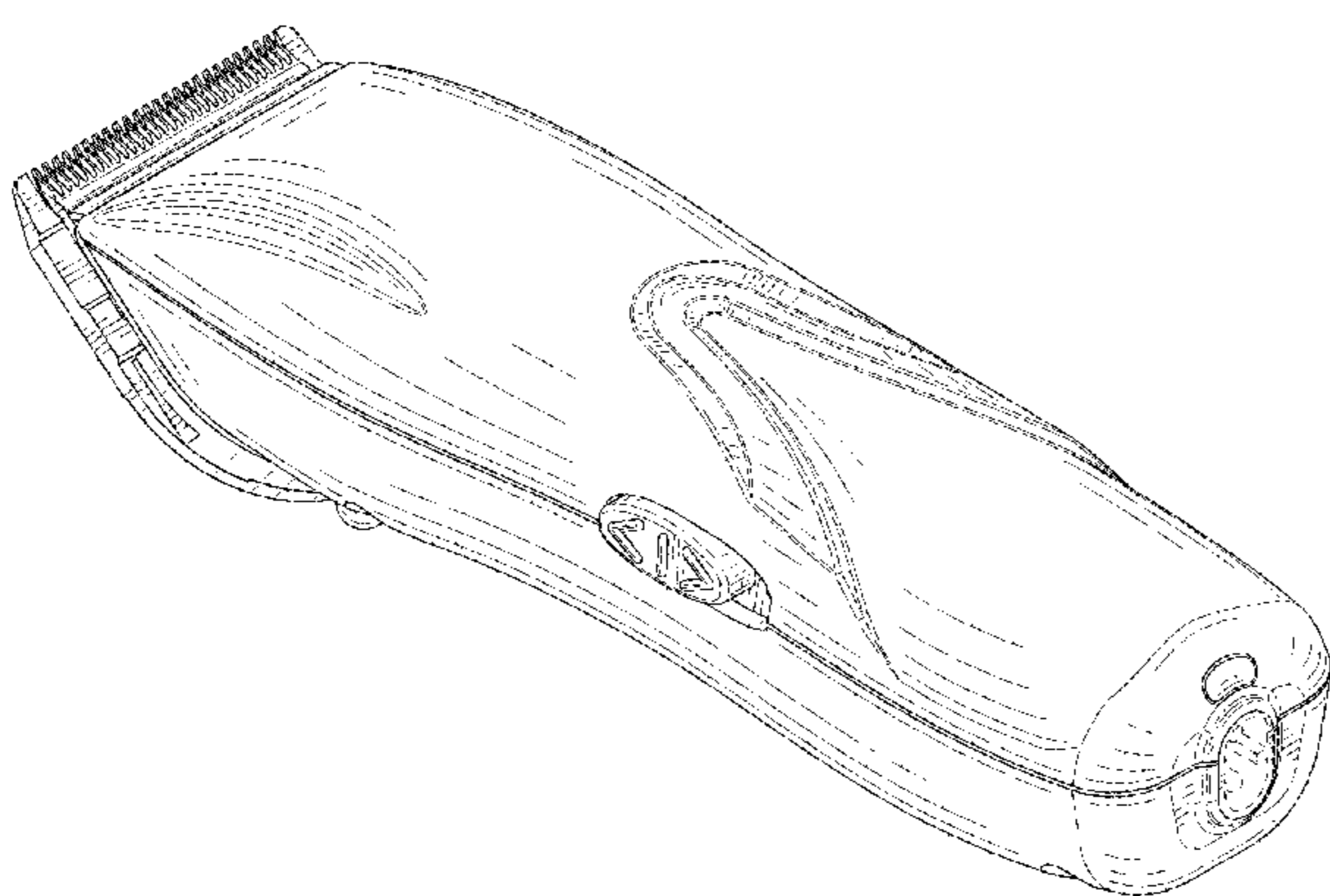

(58) **Field of Classification Search**

CPC B26B 19/00-08; B26B 19/10-107; B26B
19/20-205; B26B 19/38-3833; B26B
19/3853-3866; B26B 19/3886

See application file for complete search history.

(56) **References Cited**

U.S. PATENT DOCUMENTS

D524,988	S *	7/2006	Nielsen	D28/73
D560,311	S *	1/2008	Li	D28/73
7,356,934	B2 *	4/2008	McCambridge	B26B 19/06 206/351
D621,347	S *	8/2010	Aulwes	D13/108
8,141,253	B2 *	3/2012	Royle	B26B 19/06 30/34.05
D657,985	S *	4/2012	Scheunert	D6/526
D673,498	S *	1/2013	Colle	D13/108
D674,556	S *	1/2013	Weinberg	D28/53
D790,132	S *	6/2017	Aulwes	D28/54
D800,965	S *	10/2017	Aulwes	D28/53
D821,652	S *	6/2018	Skuhra	D28/53
2013/0200823	A1 *	8/2013	Chan	H02K 33/16 318/3

* cited by examiner

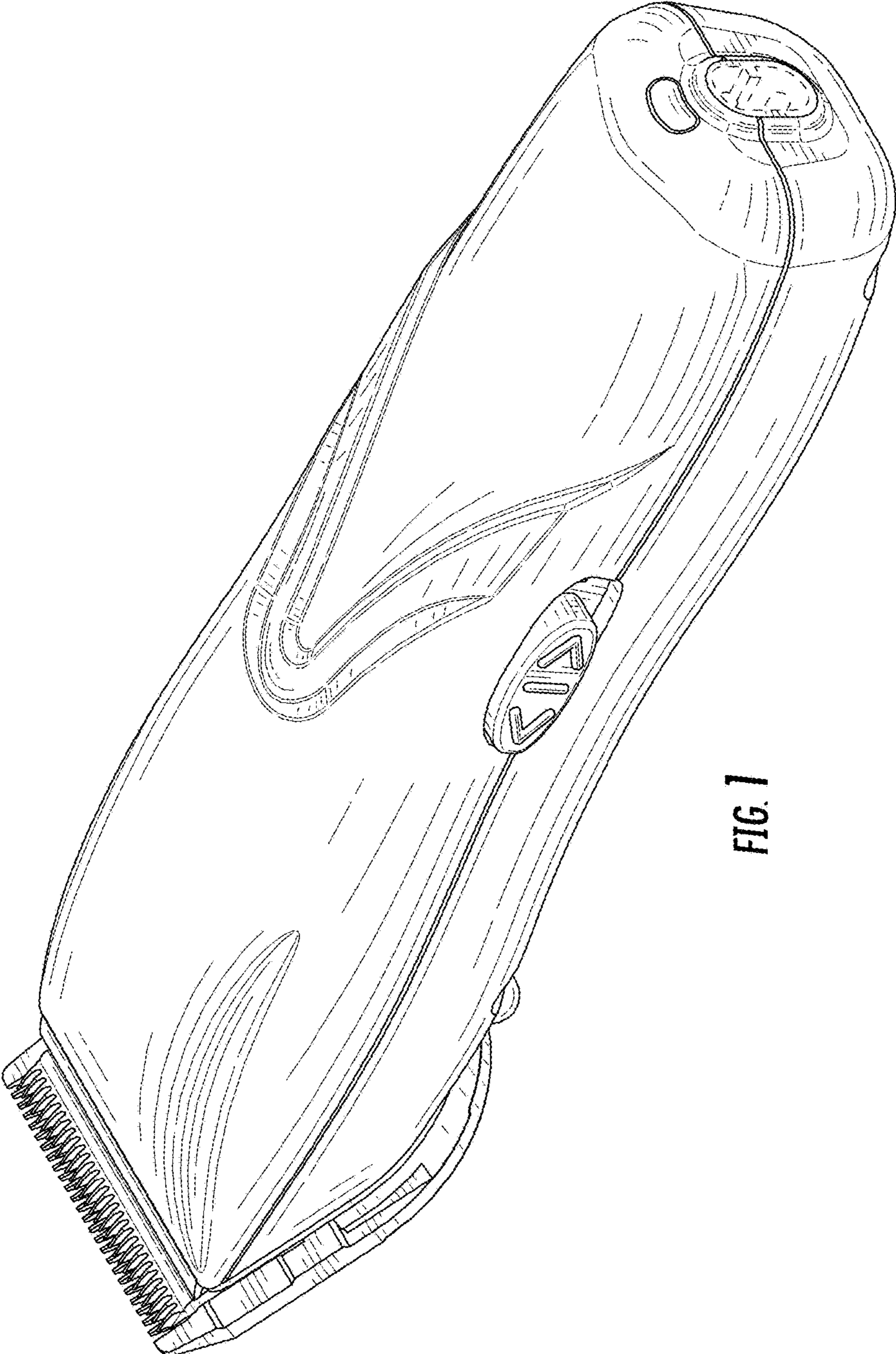

FIG. 1

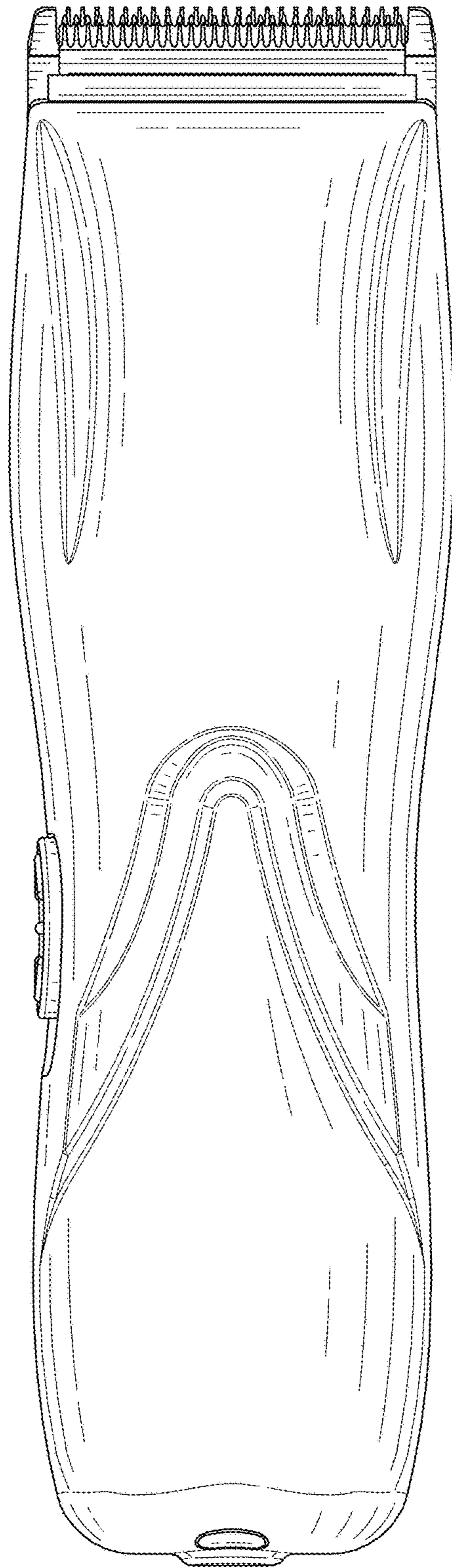

FIG. 2

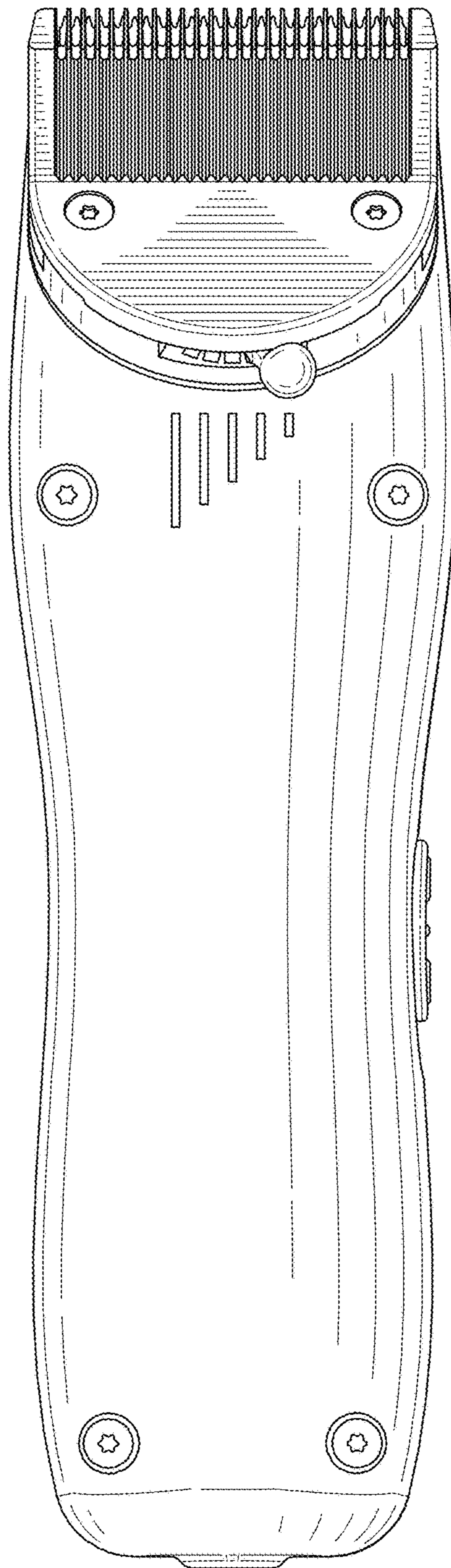

FIG. 3

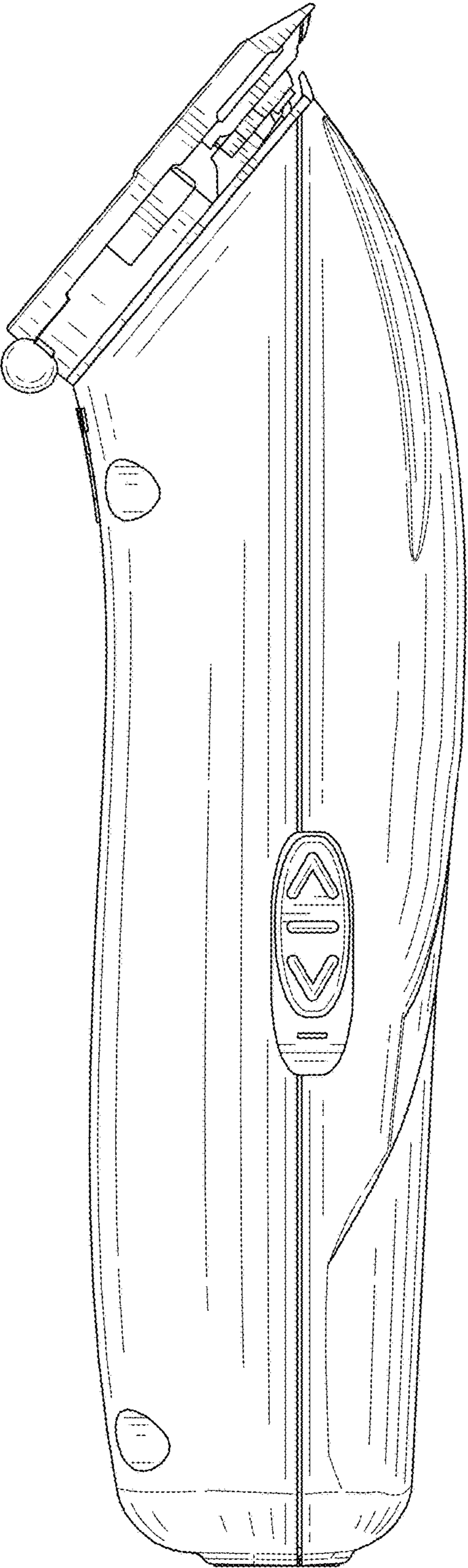

FIG. 4

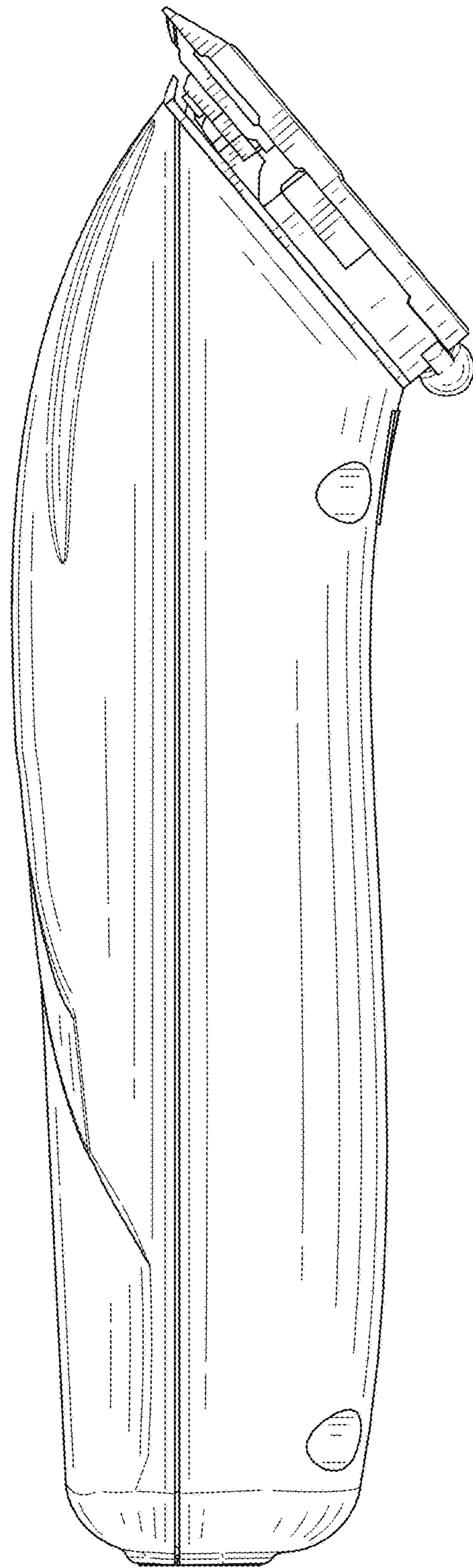

FIG. 5

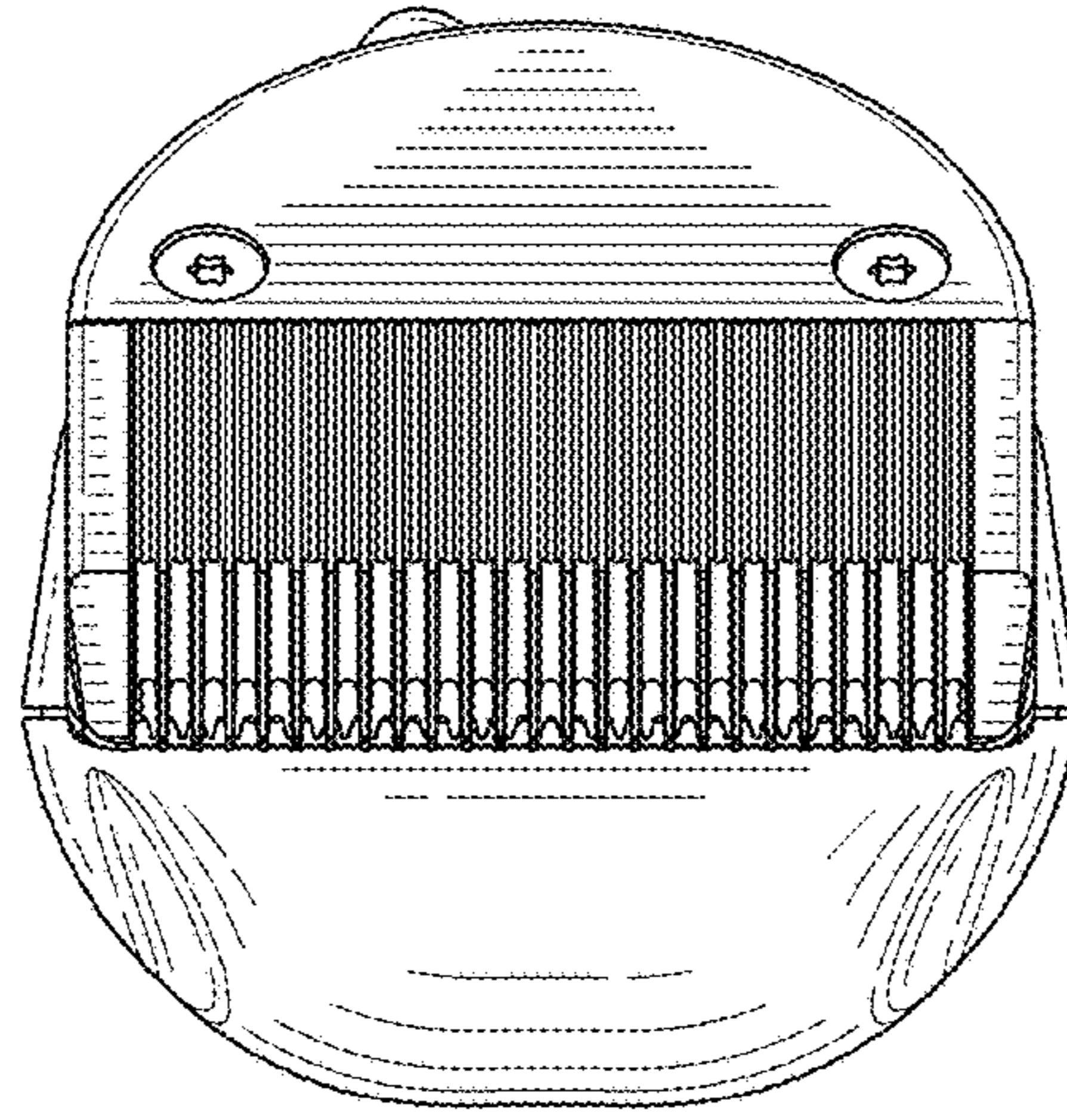

FIG. 6

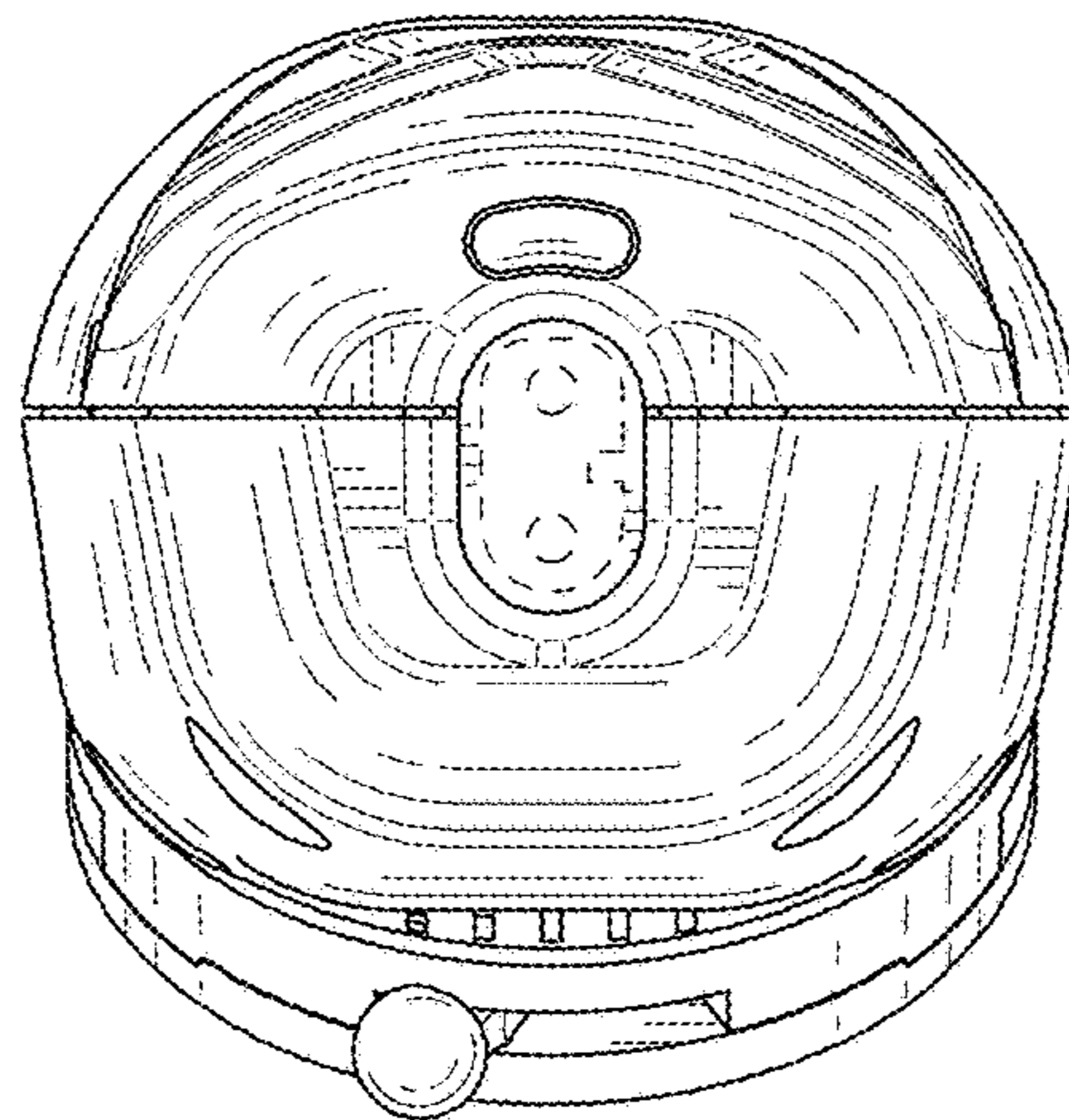

FIG. 7

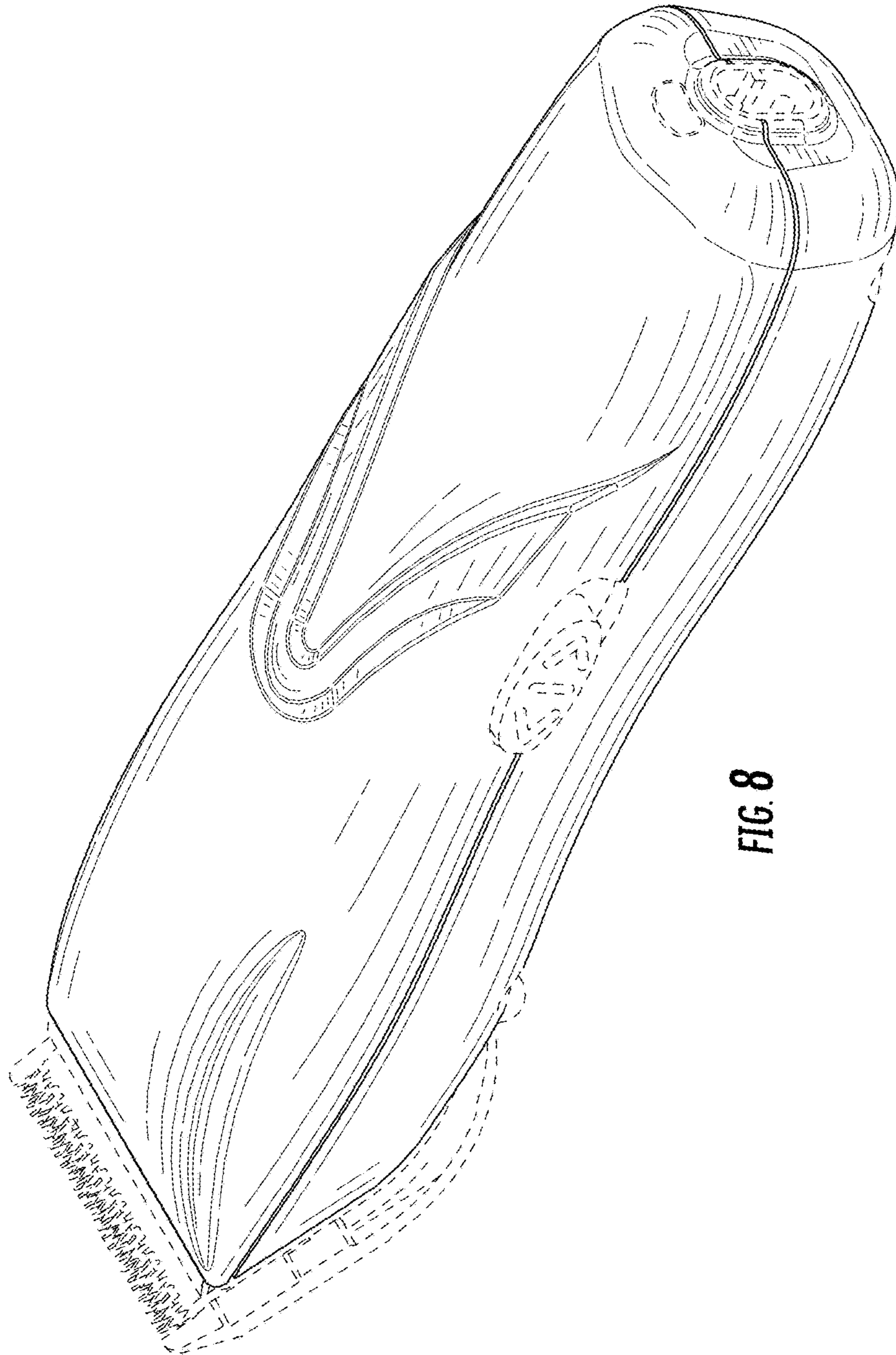

FIG. 8

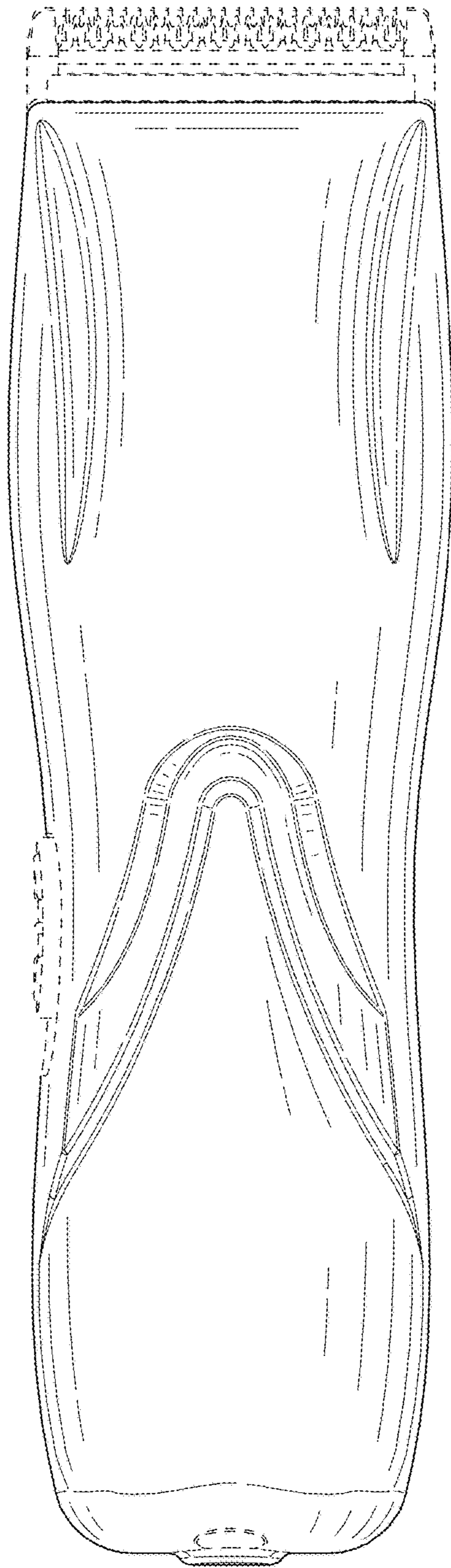

FIG. 9

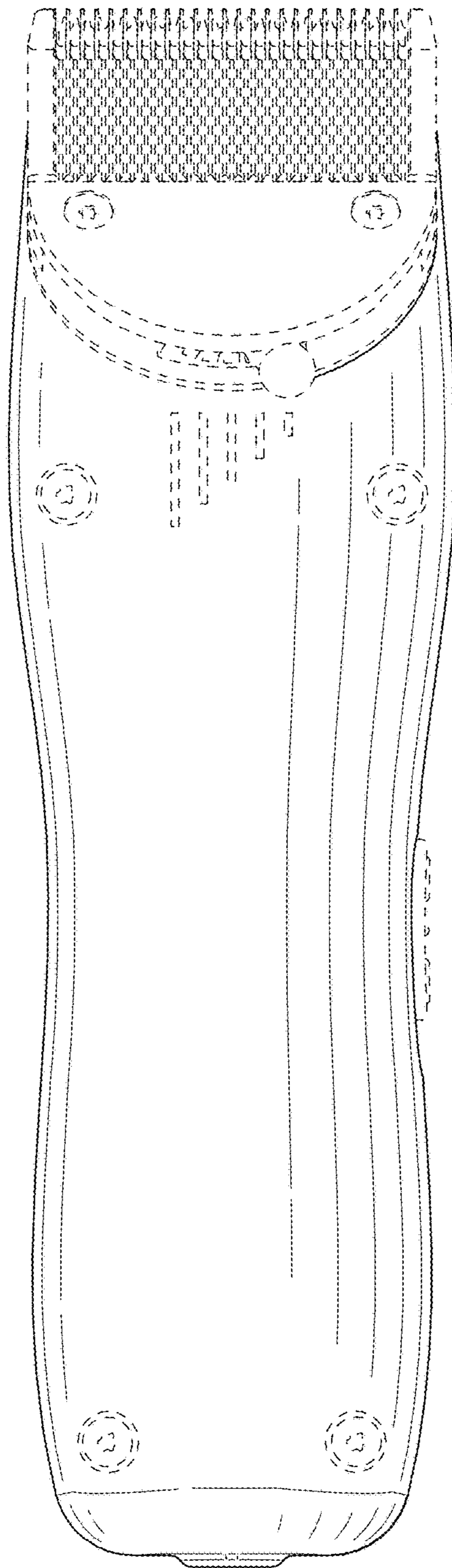

FIG. 10

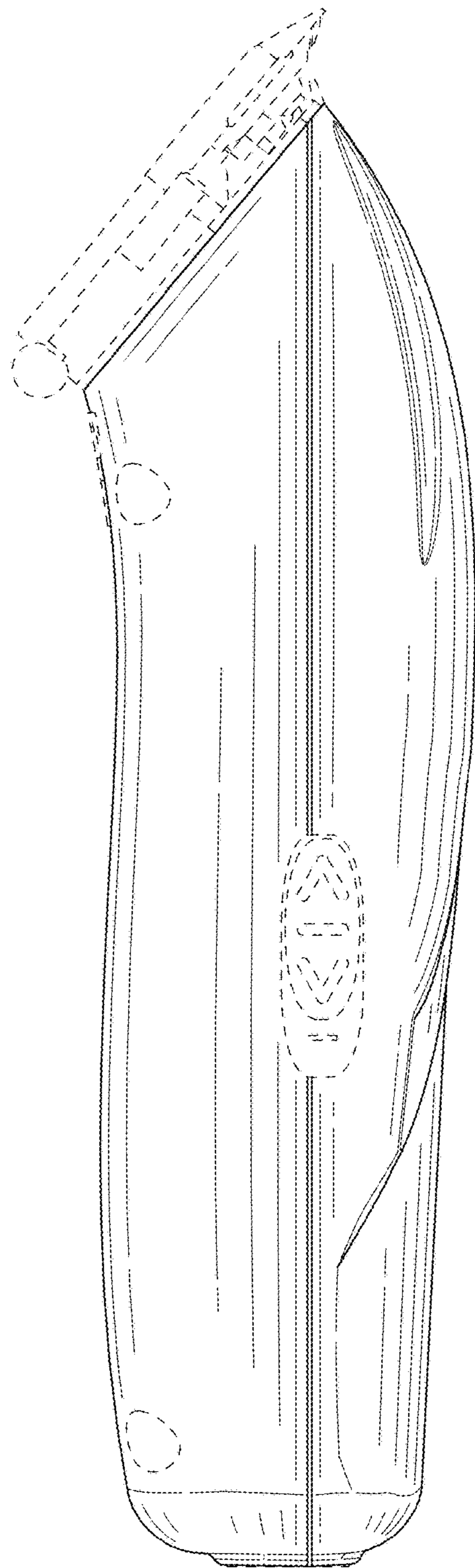

FIG. 11

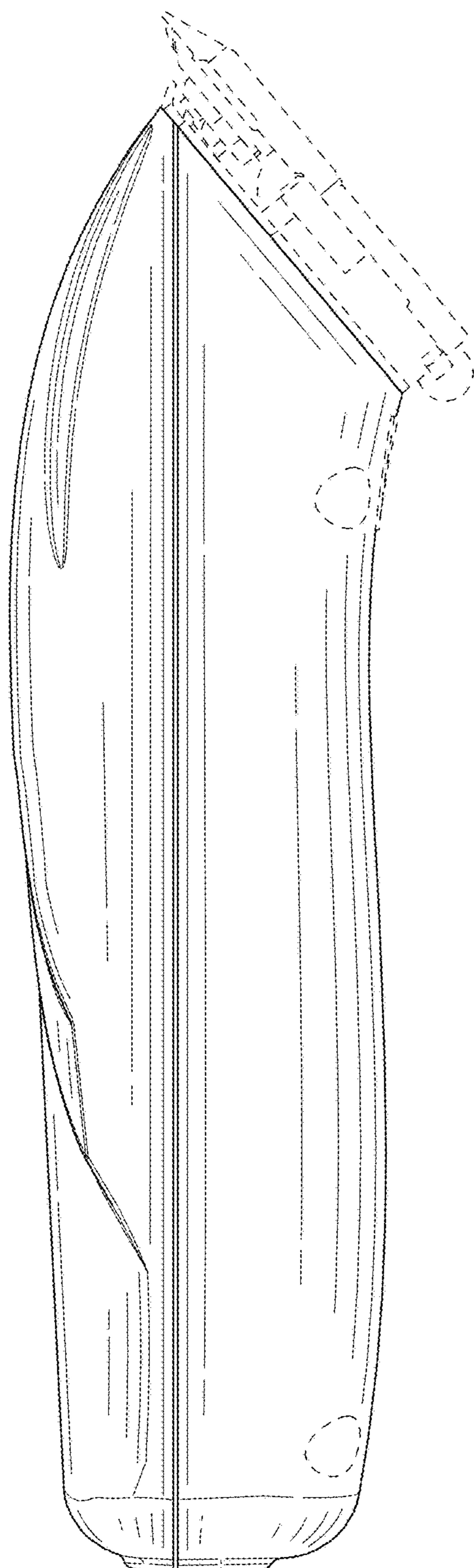

FIG. 12

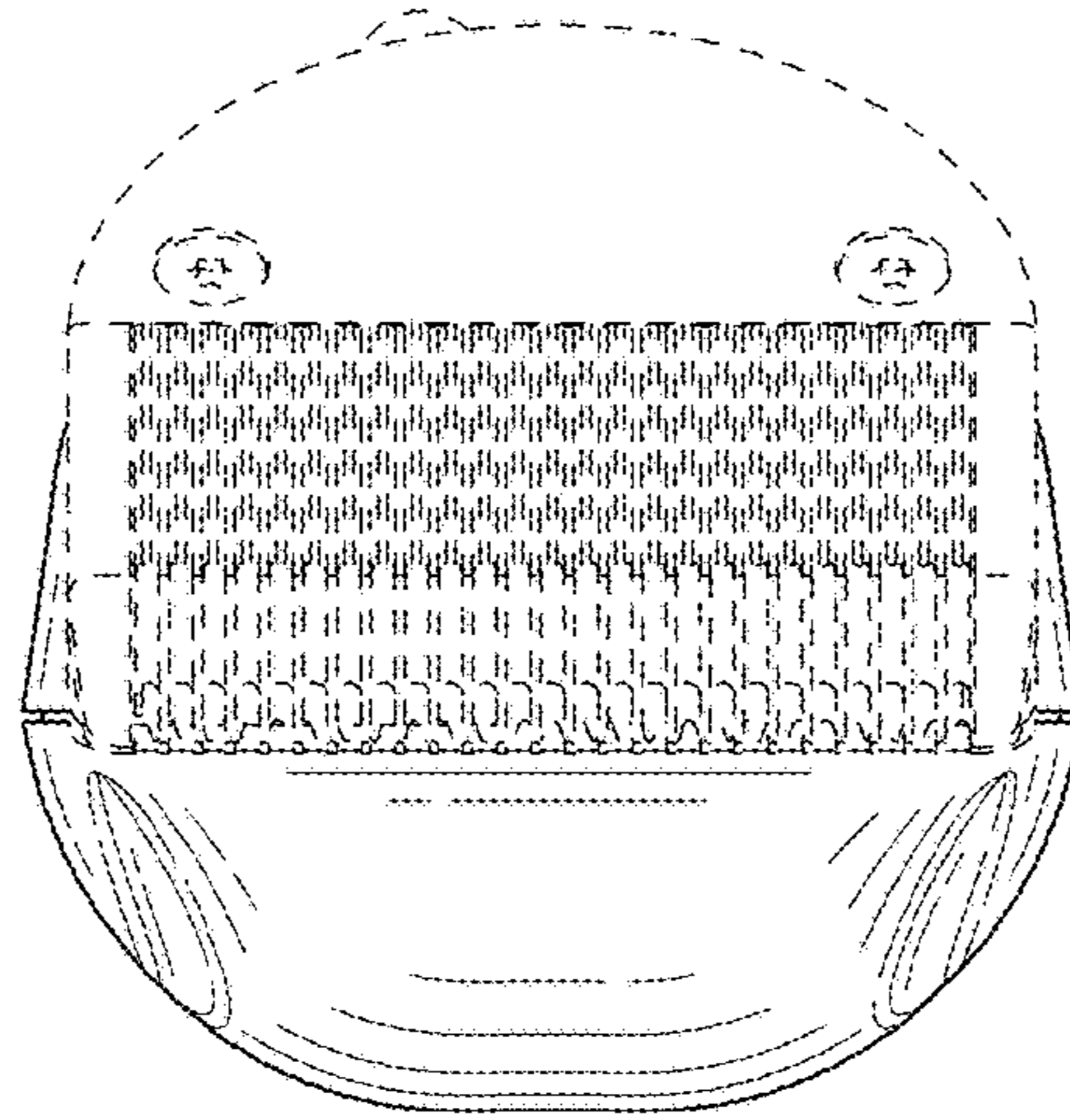

FIG. 13

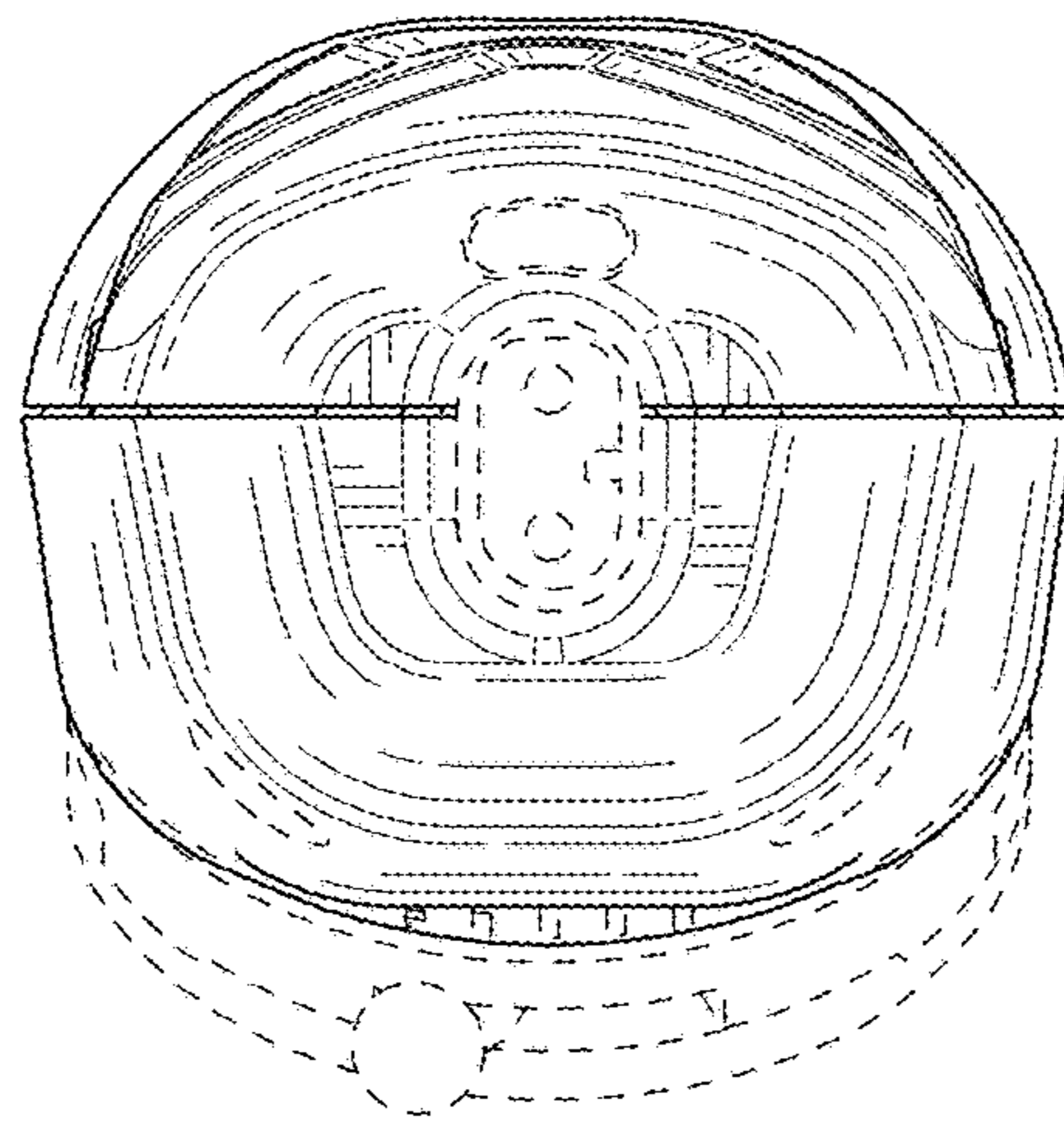

FIG. 14

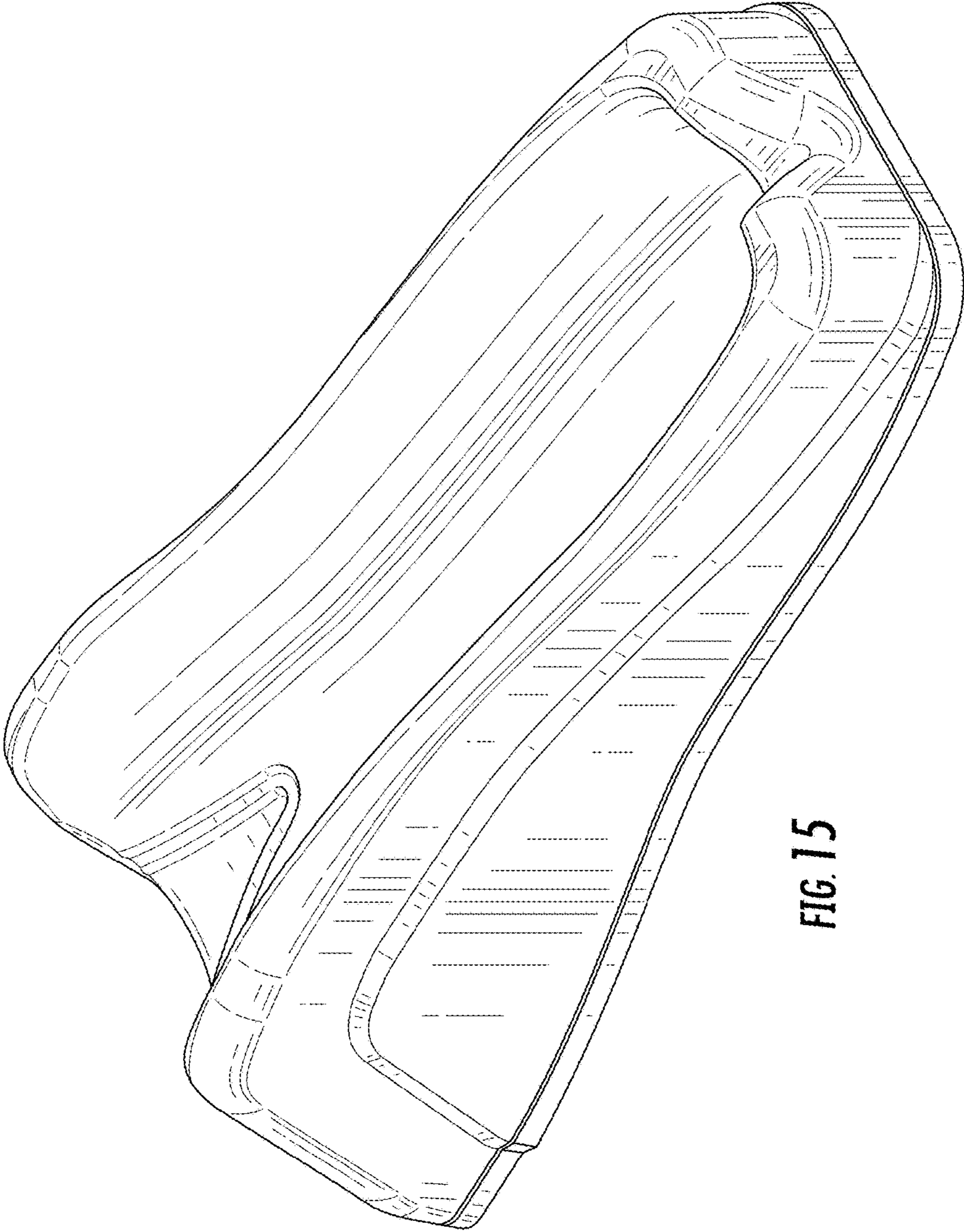

FIG. 15

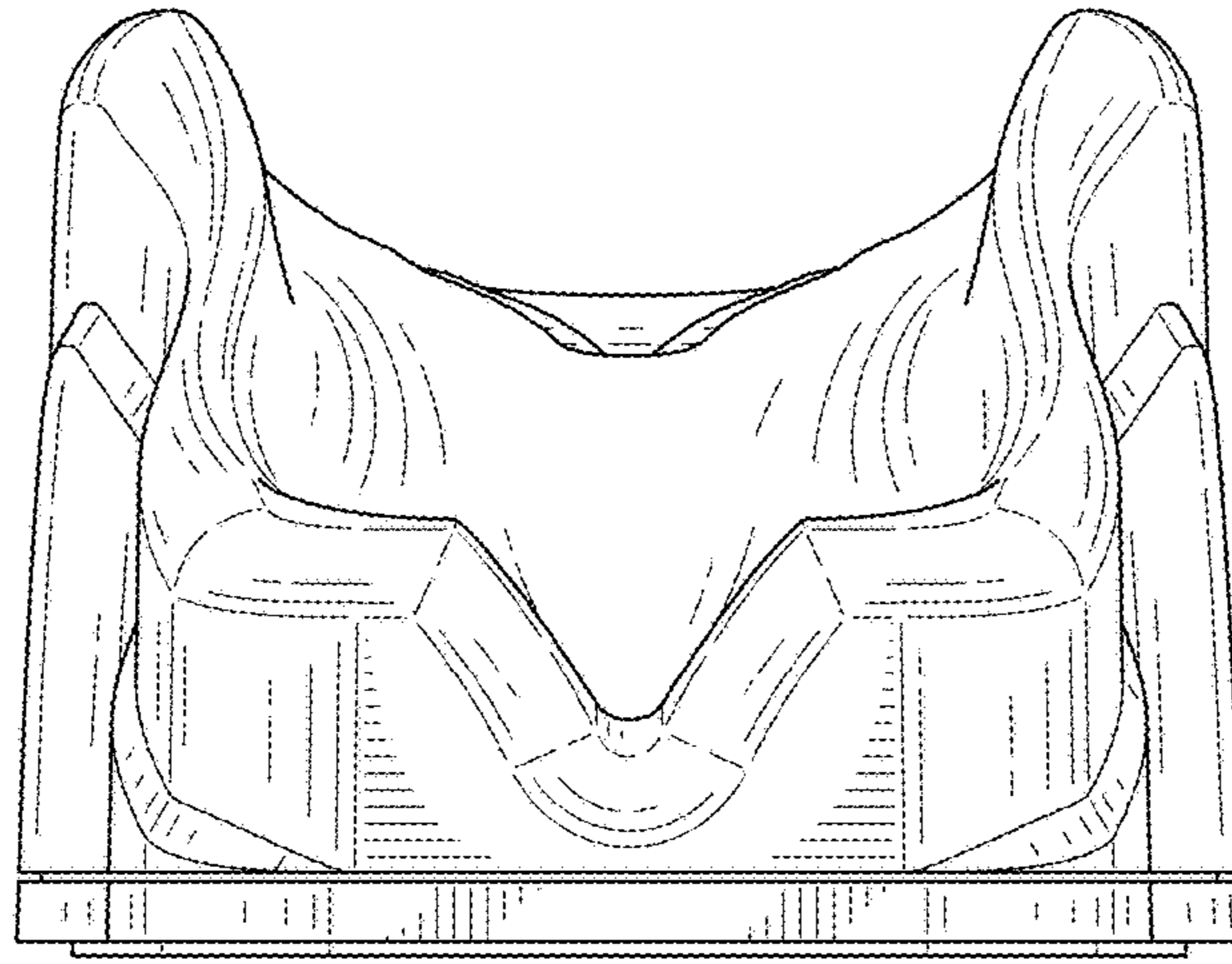

FIG. 16

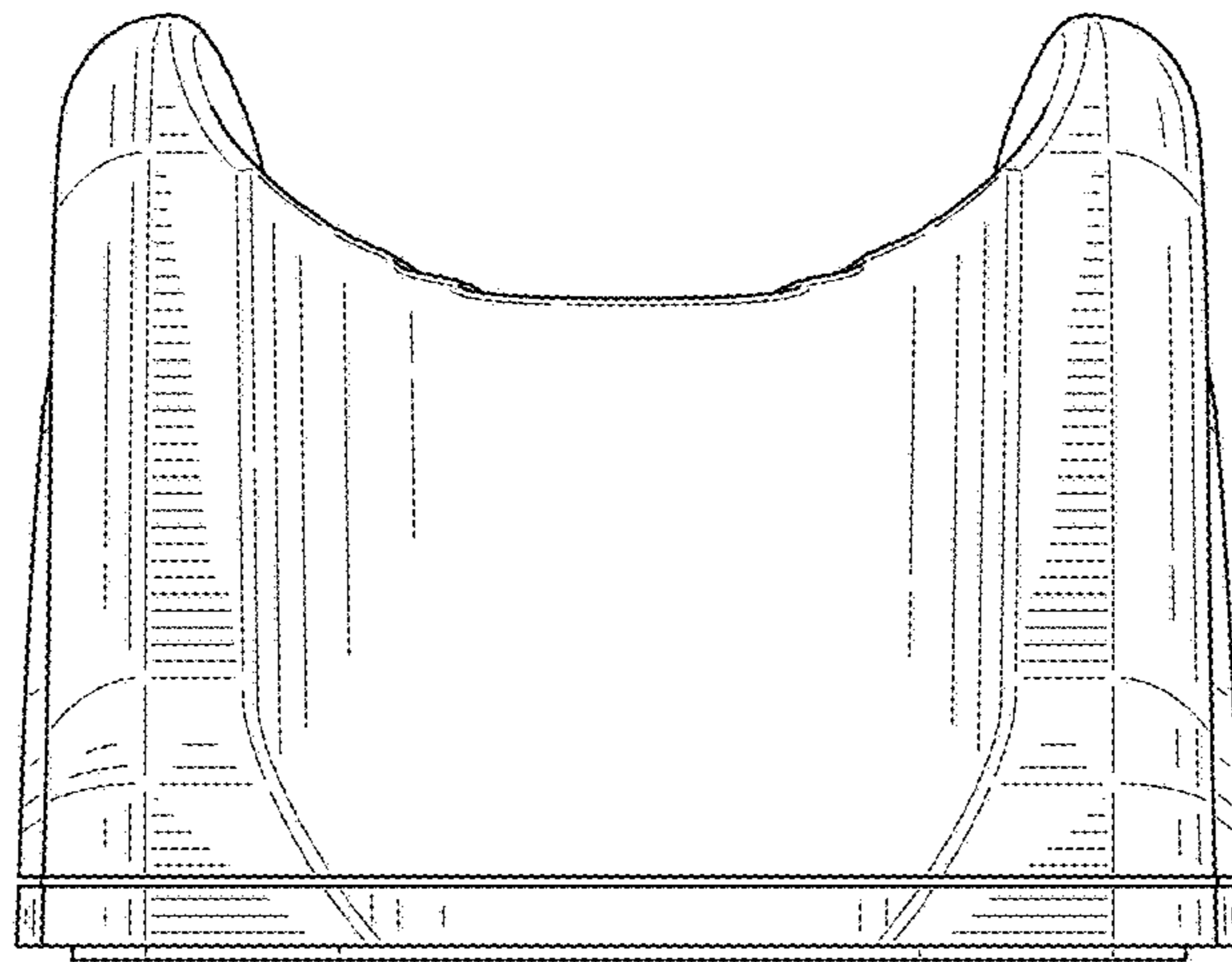

FIG. 17

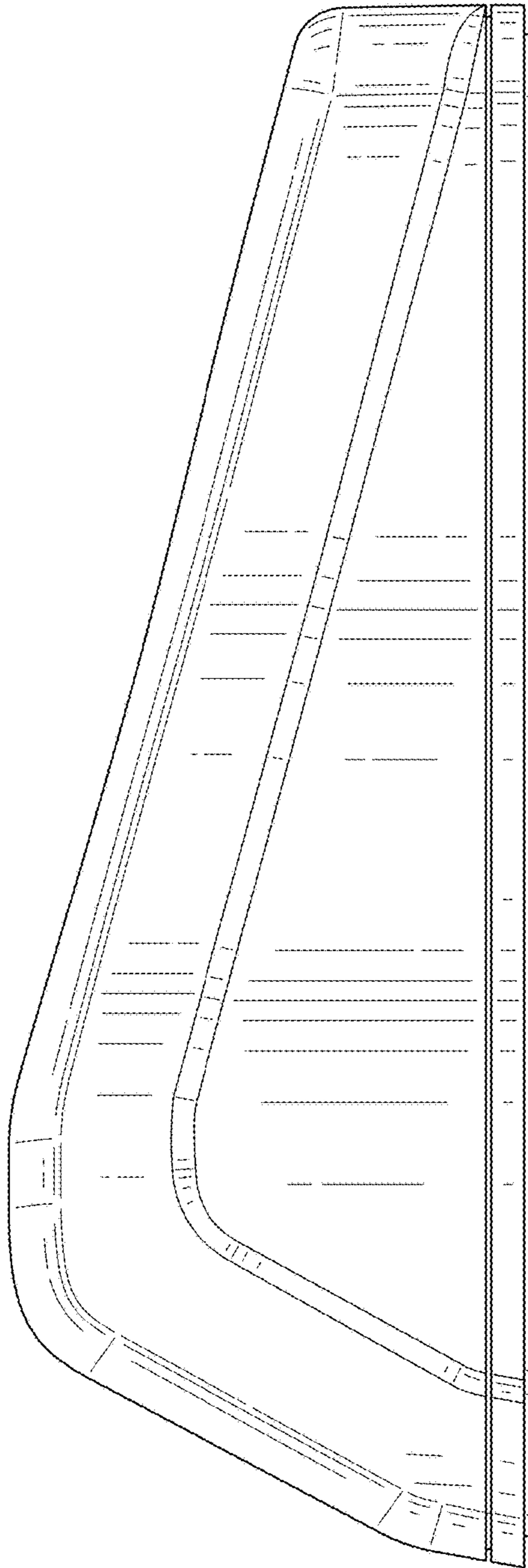

FIG. 18

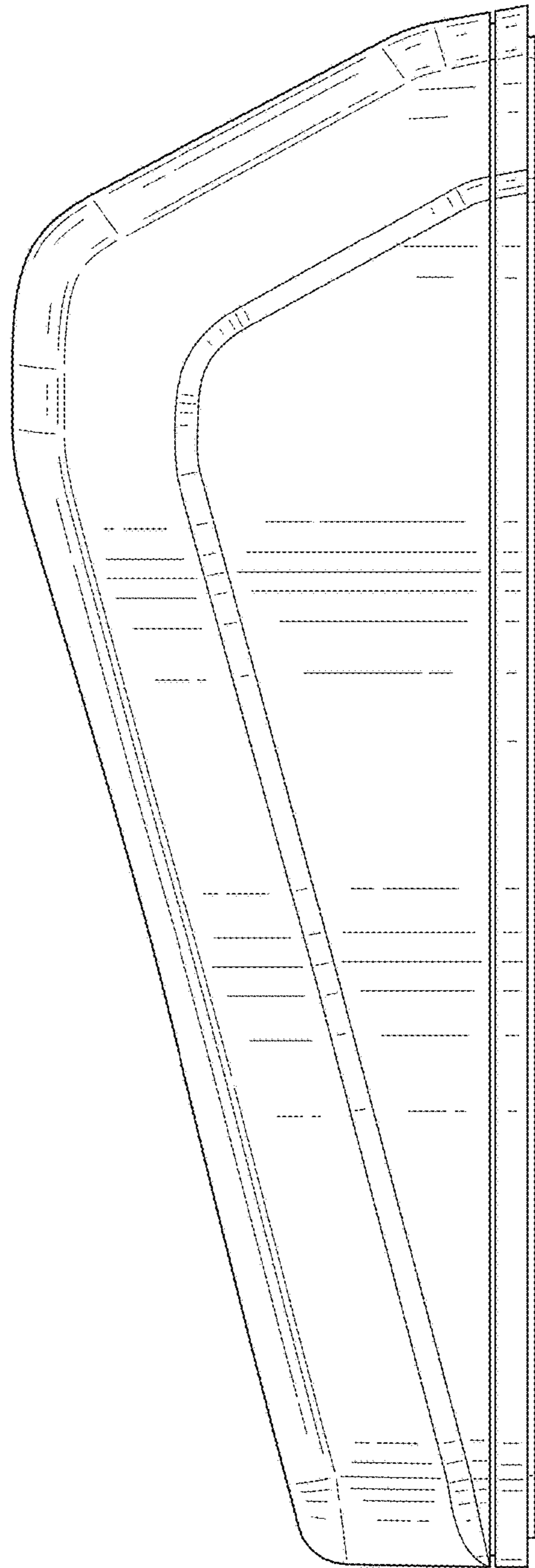

FIG. 19

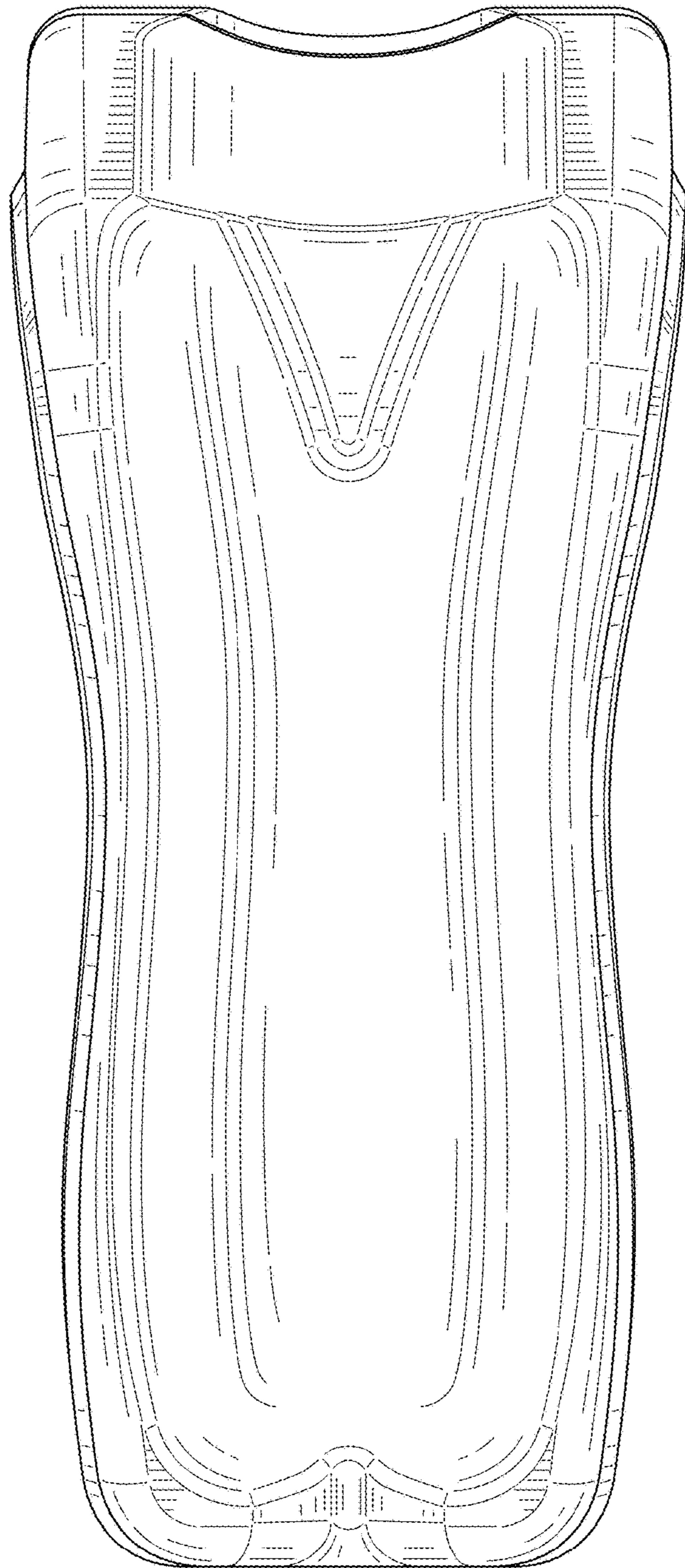

FIG. 20

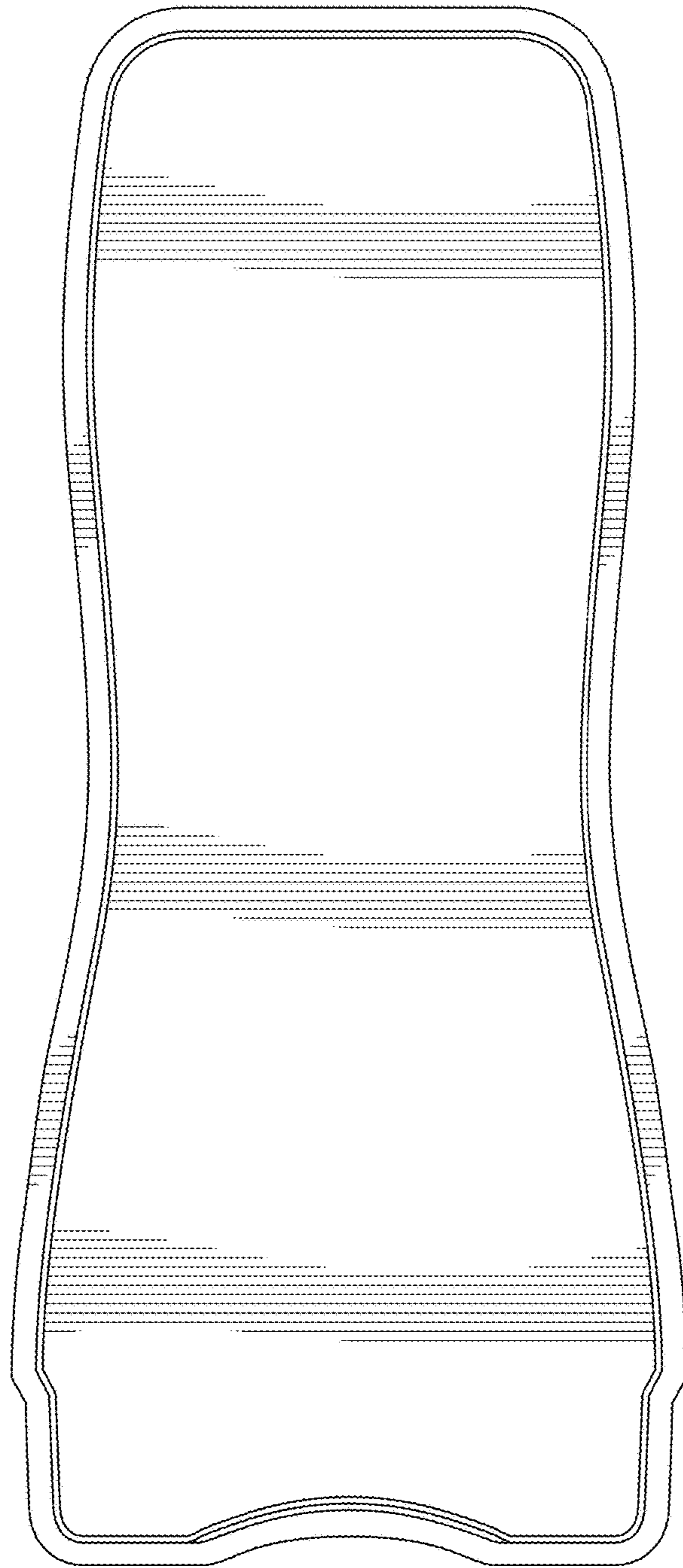

FIG. 21