

US00D865239S

(12) **United States Design Patent** (10) **Patent No.:** **US D865,239 S**
Yu et al. (45) **Date of Patent:** **** Oct. 29, 2019**

(54) **LAMP COVER**

CPC F21S 48/00; F21S 48/10; F21S 48/115;
F21S 48/225; F21S 48/1233; F21S
48/1266; F21S 48/1388; F21S 48/2268;
F21K 9/00; F21K 29/004

(71) Applicant: **CUB ELECPARTS INC.**, Fuxing
Township, Changhua County (TW)

See application file for complete search history.

(72) Inventors: **San-Chuan Yu**, Fuxing Township,
Changhua County (TW); **Ching-Jui
Chuang**, Fuxing Township, Changhua
County (TW); **Yi-Hui Hsu**, Fuxing
Township, Changhua County (TW);
Cheng-Hsin Li, Fuxing Township,
Changhua County (TW); **Wei-Chang
Liang**, Fuxing Township, Changhua
County (TW); **Chi-Ling Chang**, Fuxing
Township, Changhua County (TW);
Ya-Ling Chi, Fuxing Township,
Changhua County (TW)

(56) **References Cited**

U.S. PATENT DOCUMENTS

D316,461 S * 4/1991 McGlothlin D26/139
D318,537 S * 7/1991 Allman D26/139
D632,424 S * 2/2011 Fesler D26/139
D660,507 S * 5/2012 Davidson D26/139

* cited by examiner

Primary Examiner — Marcus A Jackson

(74) *Attorney, Agent, or Firm* — Muncy, Geissler, Olds &
Lowe, PC

(73) Assignee: **CUB ELECPARTS INC.**, Changhua
County (TW)

(57) **CLAIM**

The ornamental design for a lamp cover, as shown.

(**) Term: **15 Years**

DESCRIPTION

(21) Appl. No.: **29/653,679**

FIG. 1 is a perspective view of a lamp cover, showing the
new design;

(22) Filed: **Jun. 18, 2018**

FIG. 2 is a front elevational view thereof;

(30) **Foreign Application Priority Data**

May 29, 2018 (TW) 107303019

FIG. 3 is a rear elevational view thereof;

(51) **LOC (12) Cl.** **26-06**

FIG. 4 is a left side elevational view thereof;

(52) **U.S. Cl.**

FIG. 5 is a right side elevational view thereof;

USPC **D26/28**

FIG. 6 is a top plan view thereof;

(58) **Field of Classification Search**

FIG. 7 is a bottom plan view thereof;

USPC D26/28–36

FIG. 8 is another perspective view thereof; and,

FIG. 9 is still another perspective view thereof.

1 Claim, 9 Drawing Sheets

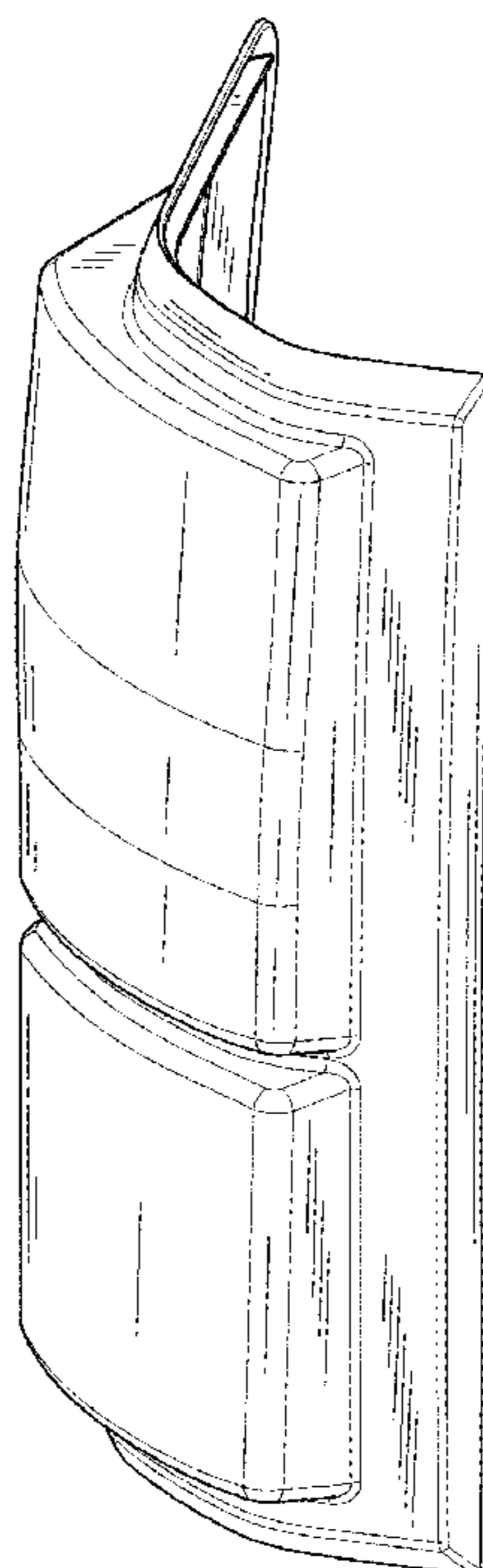

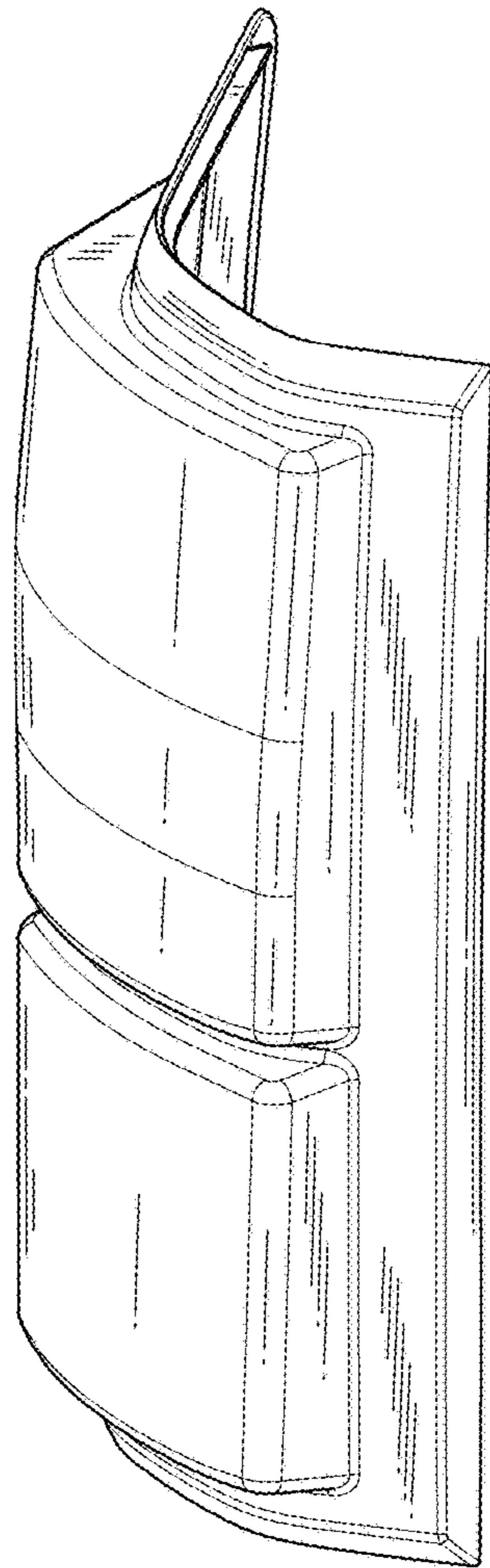

FIG. 1

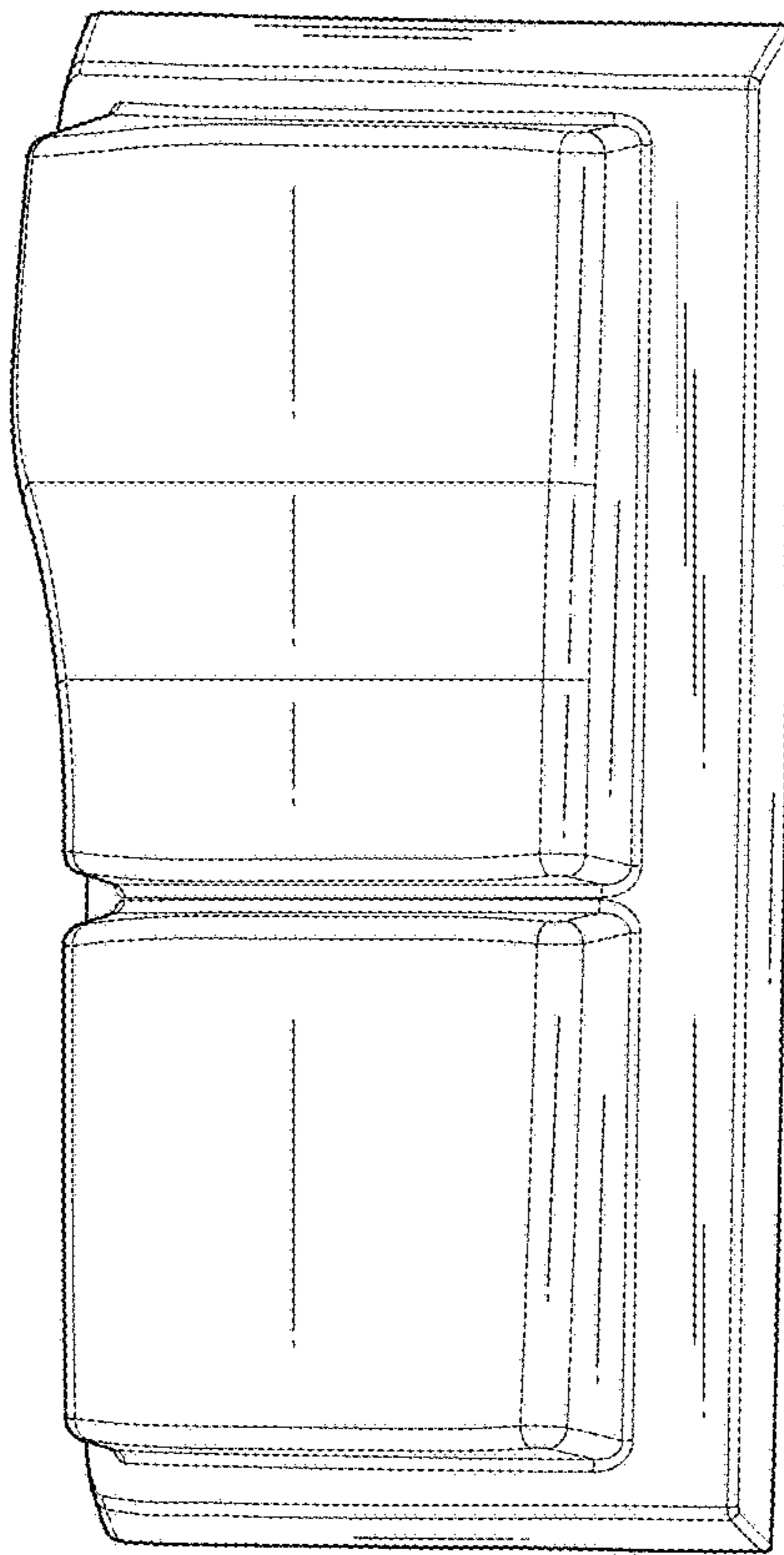

FIG. 2

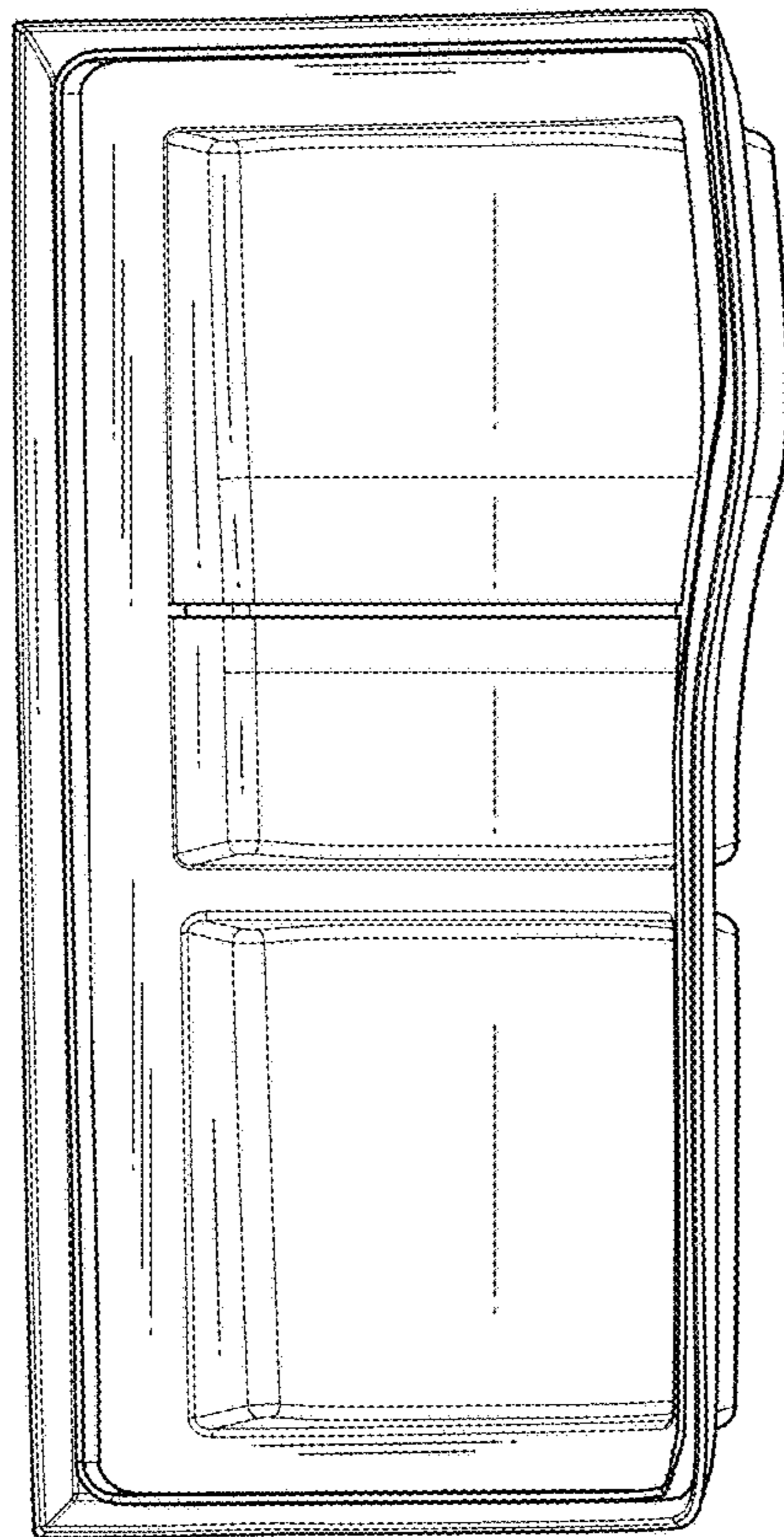

FIG. 3

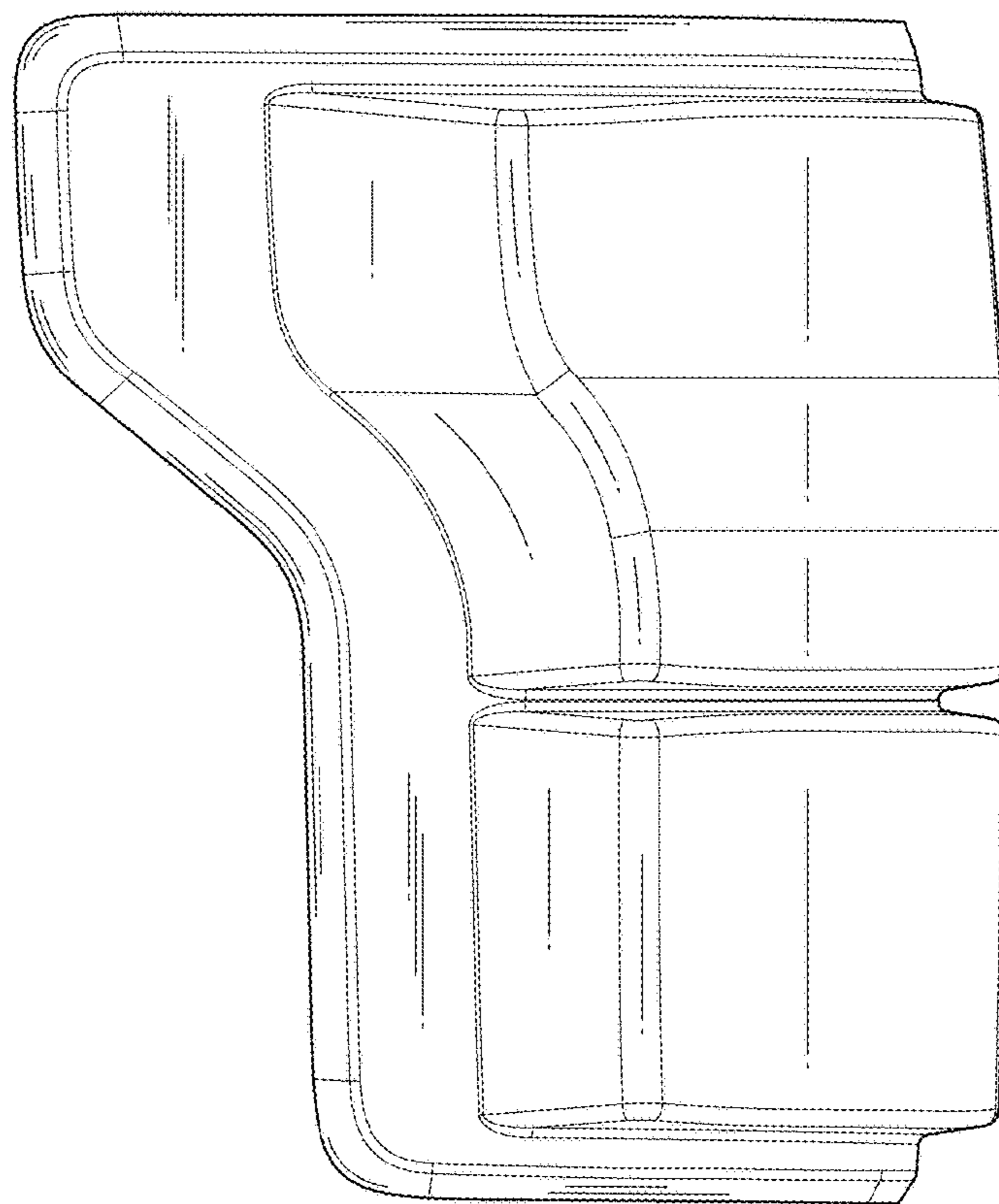

FIG. 4

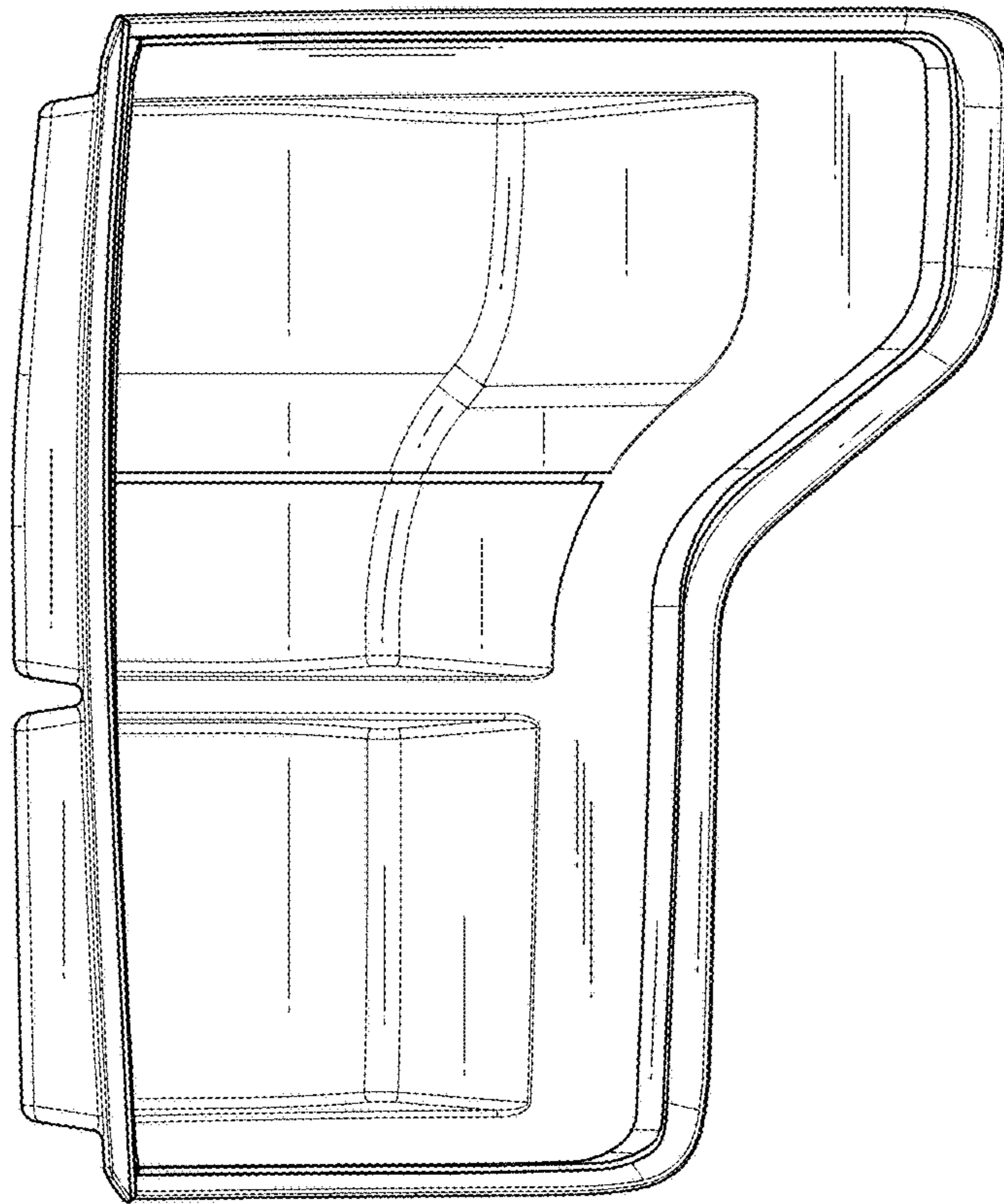

FIG. 5

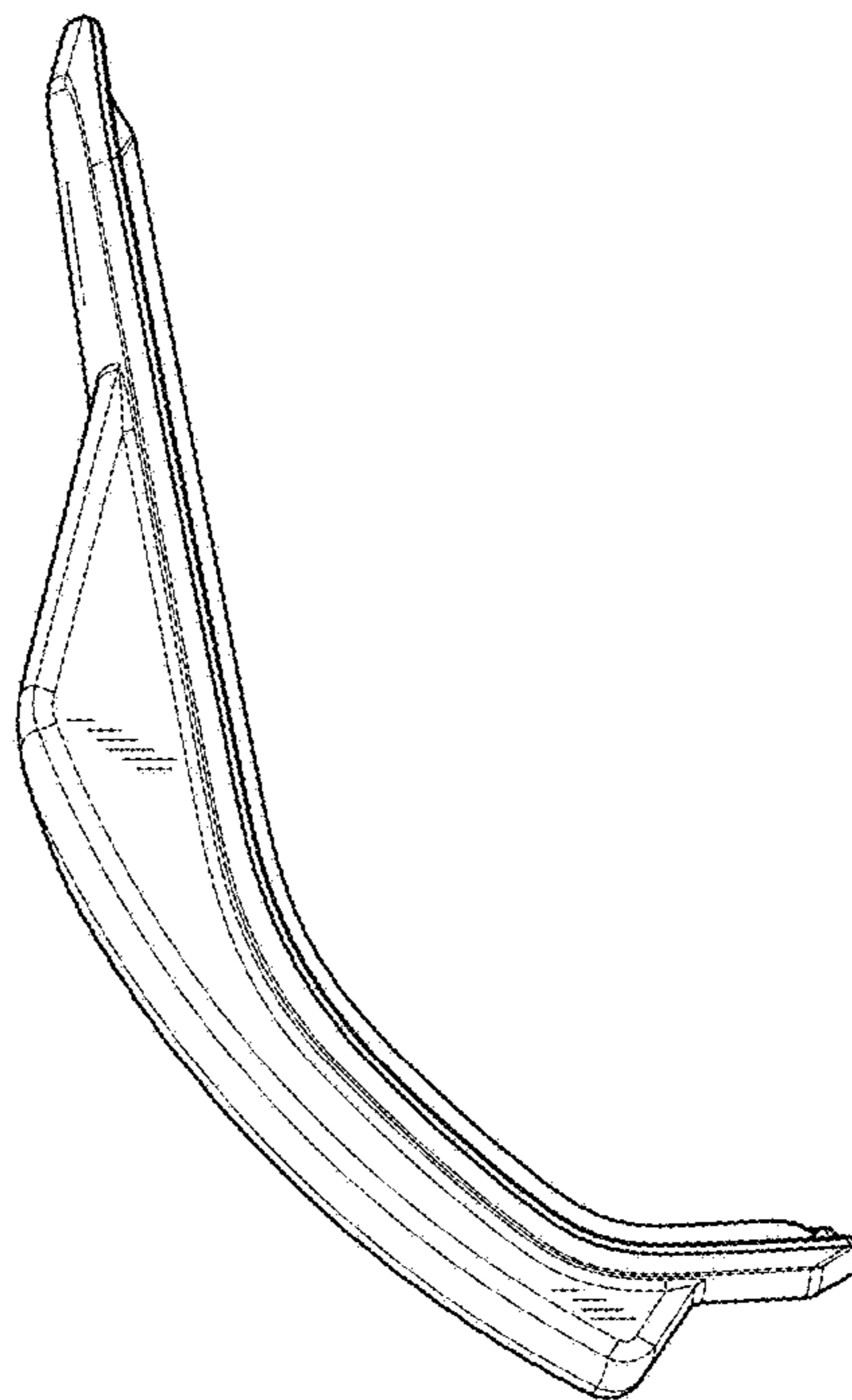

FIG. 6

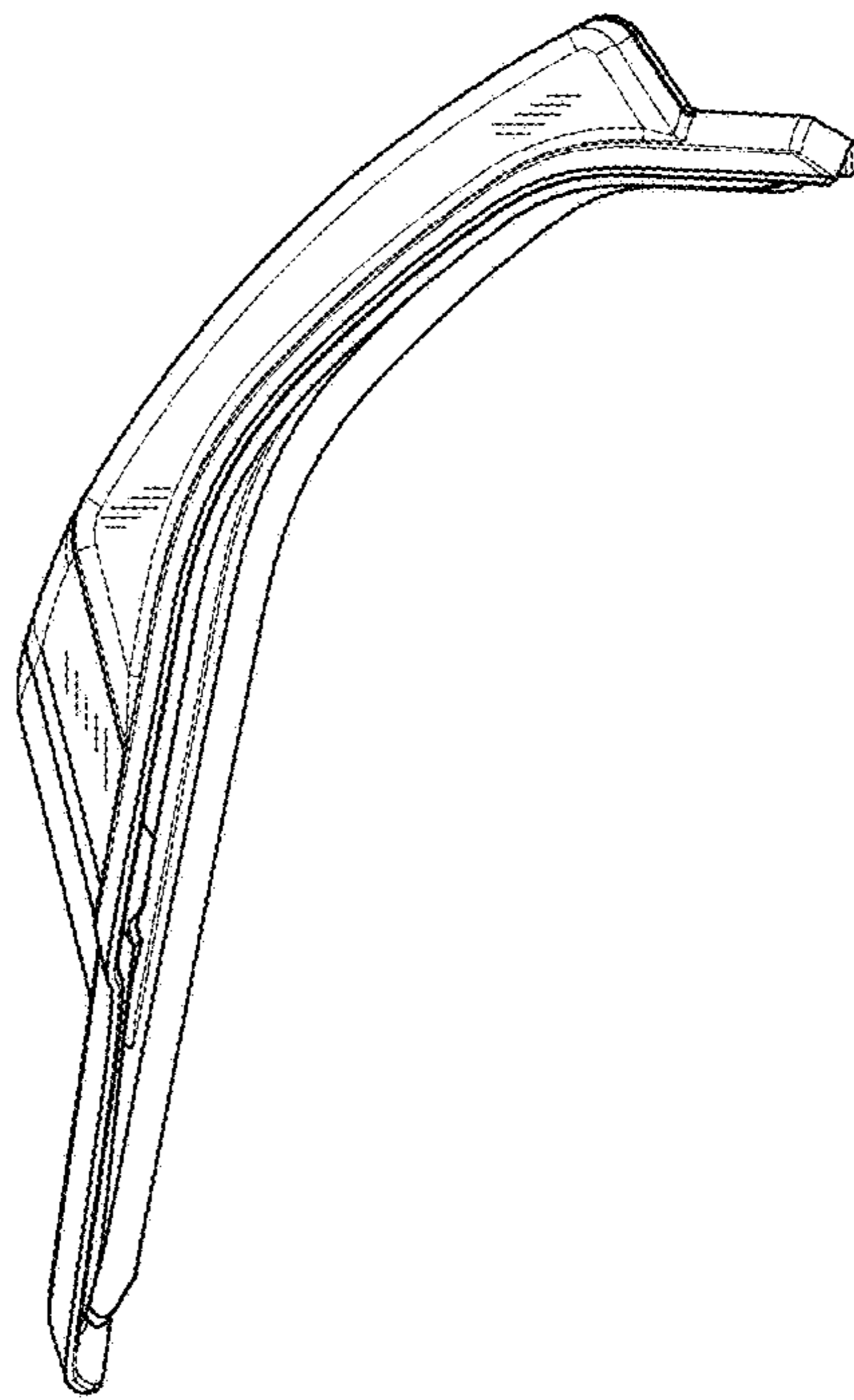

FIG. 7

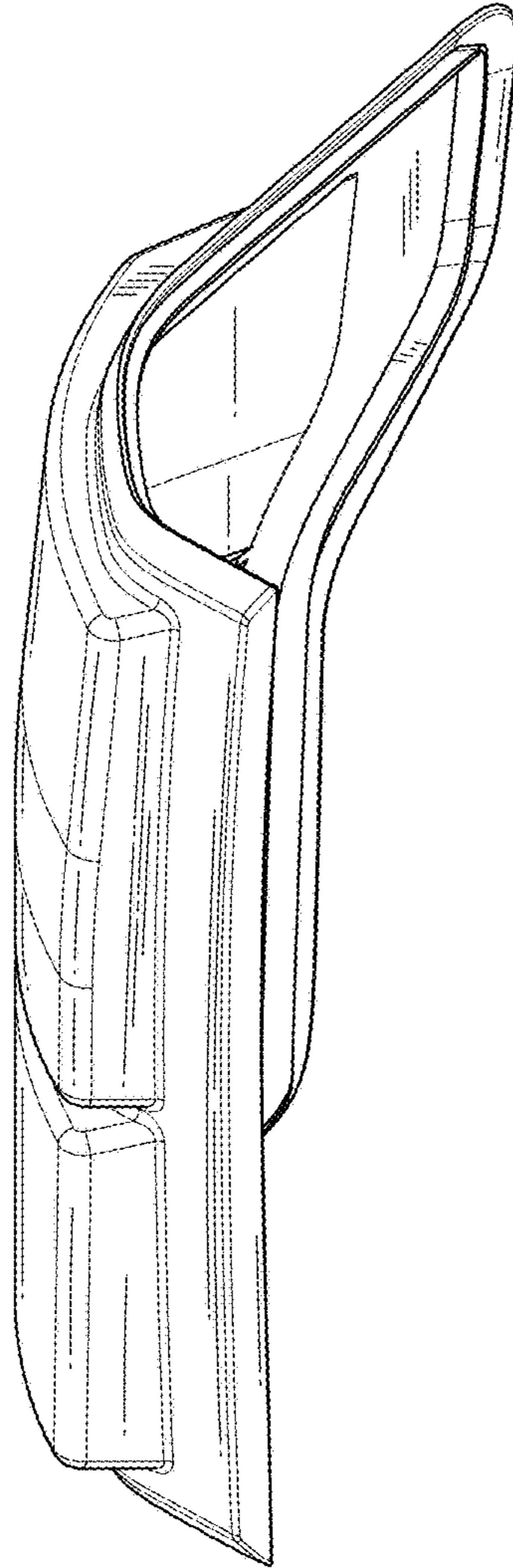

FIG. 8

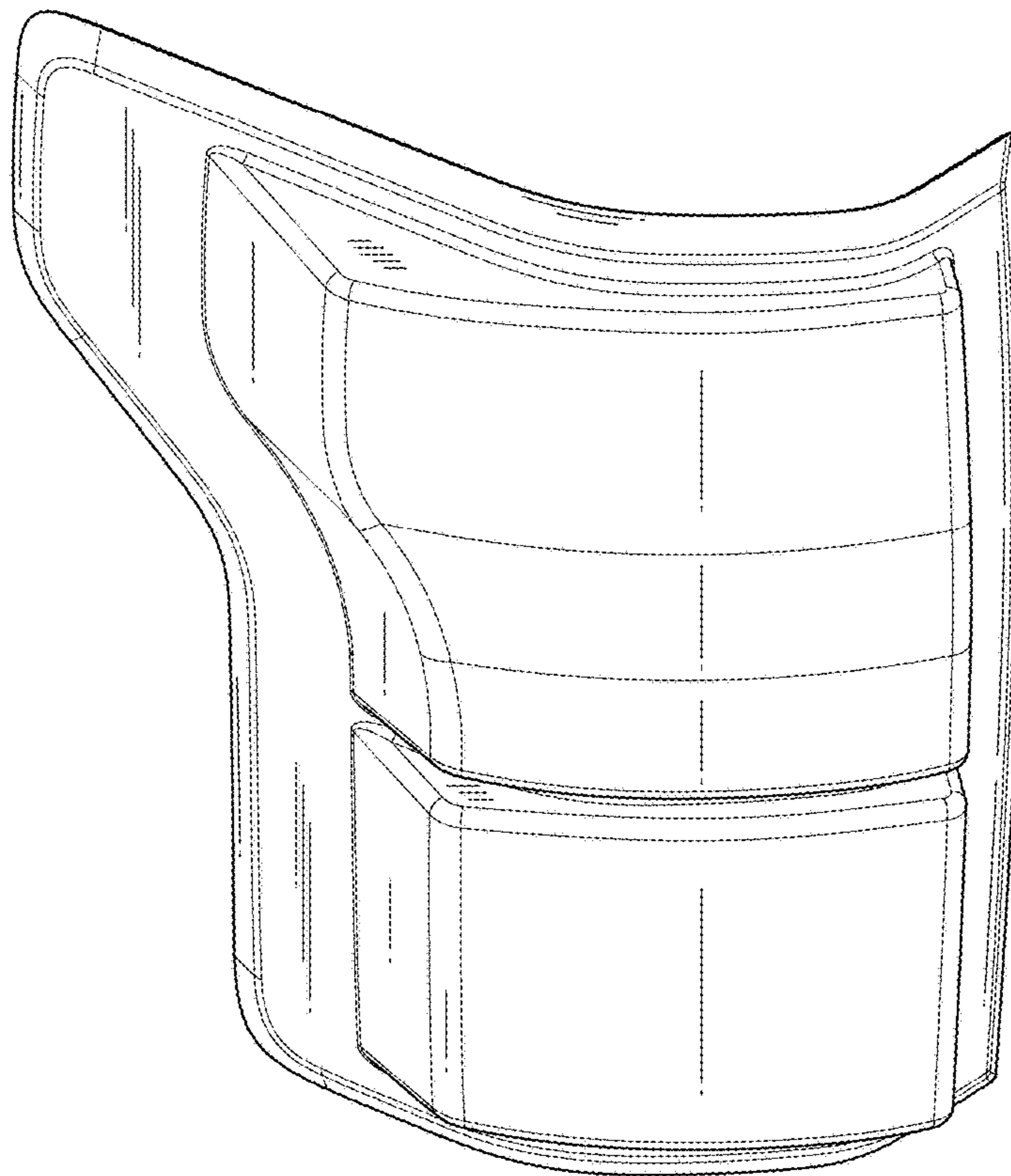

FIG. 9