



US00D865218S

(12) **United States Design Patent** (10) **Patent No.:** **US D865,218 S**
Mathers et al. (45) **Date of Patent:** **** Oct. 29, 2019**

(54) **THERMAL CYCLER HOUSING**
(71) Applicants: **LIFE TECHNOLOGIES CORPORATION**, Carlsbad, CA (US); **LIFE TECHNOLOGIES HOLDINGS PTE LIMITED**, Singapore (SG)
(72) Inventors: **Xin Mathers**, Poway, CA (US); **Sandro Klein**, Irvine, CA (US); **Tiong Han Toh**, Singapore (SG); **Huei Steven Yeo**, Singapore (SG)
(73) Assignee: **LIFE TECHNOLOGIES CORPORATION**, Carlsbad, CA (US)
(**) Term: **15 Years**
(21) Appl. No.: **29/625,653**
(22) Filed: **Nov. 10, 2017**
(51) **LOC (12) Cl.** **24-01**
(52) **U.S. Cl.**
USPC **D24/232**
(58) **Field of Classification Search**
USPC D24/107, 185, 186, 216, 231-234; D10/81
CPC G01N 2035/00306; G01N 2035/00366; G01N 21/6428; G01N 21/645; G01N 2201/068; C12Q 1/686; B01L 7/52
See application file for complete search history.

D733,917 S 7/2015 Klein et al.
D775,365 S * 12/2016 Mathers D24/232
D827,859 S * 9/2018 Mathers D24/232
D834,724 S * 11/2018 Mathers D24/232
2010/0124766 A1* 5/2010 Ng B01L 7/52
435/91.2
2016/0228875 A1* 8/2016 Toh B01L 7/52
2016/0228876 A1* 8/2016 Chu C12Q 1/6806
2016/0361719 A1* 12/2016 Courtney B01L 3/50851
2017/0072398 A1* 3/2017 Boo B01L 7/52
2018/0120575 A1* 5/2018 Chen G01N 21/6456

* cited by examiner

Primary Examiner — Anhdao Doan

(57) **CLAIM**

The ornamental design for a thermal cycler housing, as shown and described.

DESCRIPTION

FIG. 1 is a front perspective view of a first embodiment of a thermal cycler housing showing our new design;
FIG. 2 is a front view thereof;
FIG. 3 is a rear view thereof;
FIG. 4 is a left side view thereof;
FIG. 5 is a right side view thereof;
FIG. 6 is a top view thereof;
FIG. 7 is a bottom view thereof;
FIG. 8 is a front perspective view of a second embodiment of a thermal cycler housing showing our new design;
FIG. 9 is a front view thereof;
FIG. 10 is a rear view thereof;
FIG. 11 is a left side view thereof;
FIG. 12 is a right side view thereof;
FIG. 13 is a top view thereof; and,
FIG. 14 is a bottom view thereof.
The broken lines in the Figures show portions of the thermal cycler housing that form no part of the claimed design.

1 Claim, 14 Drawing Sheets

(56) **References Cited**
U.S. PATENT DOCUMENTS
5,525,300 A 6/1996 Danssaert et al.
D467,349 S 12/2002 Niedbala et al.
D537,951 S 3/2007 Okamoto et al.
8,046,175 B2 10/2011 Kuo et al.
8,859,271 B2 10/2014 Shin et al.
D717,968 S 11/2014 Klein et al.
D731,673 S * 6/2015 Klein D24/232

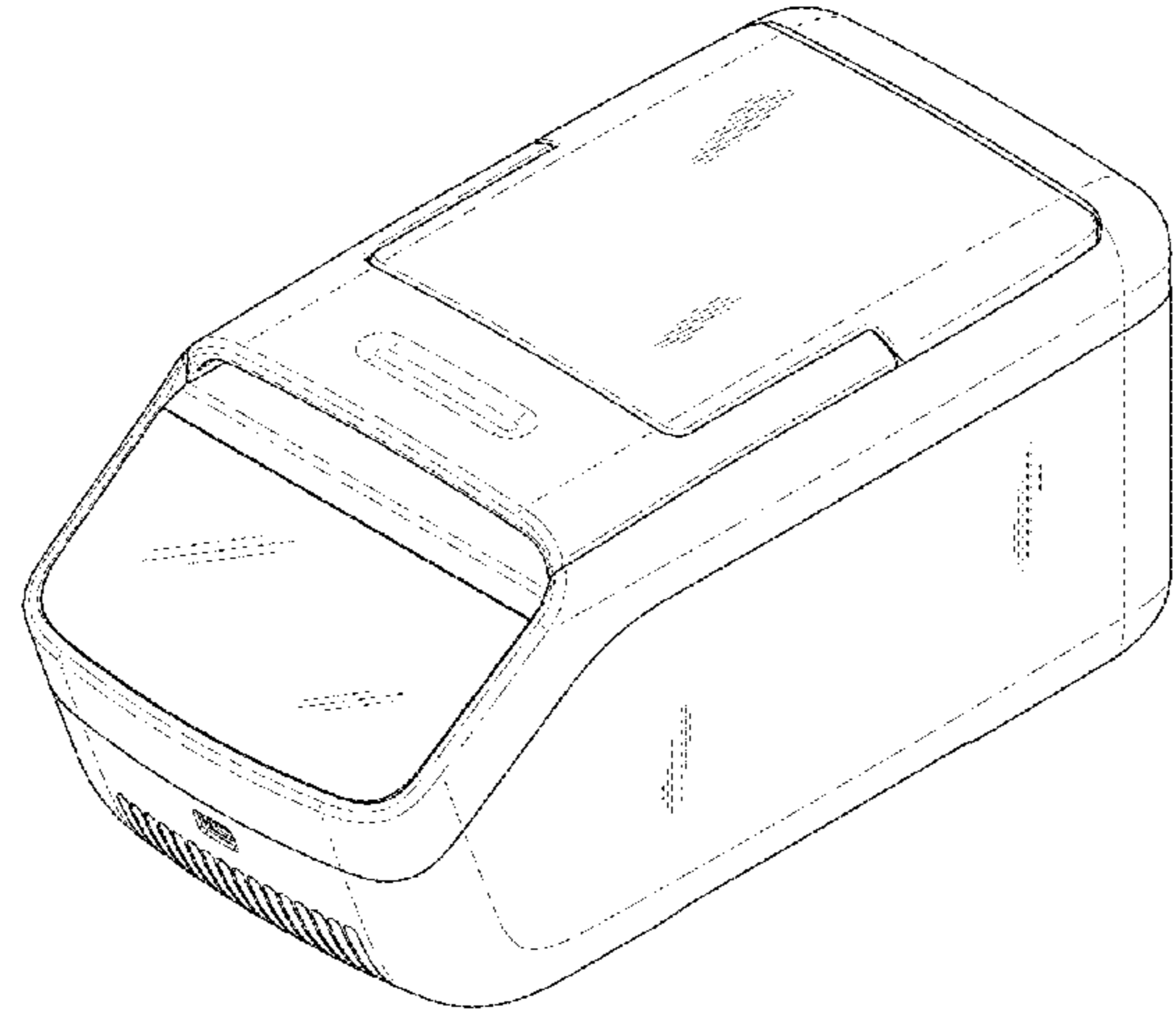

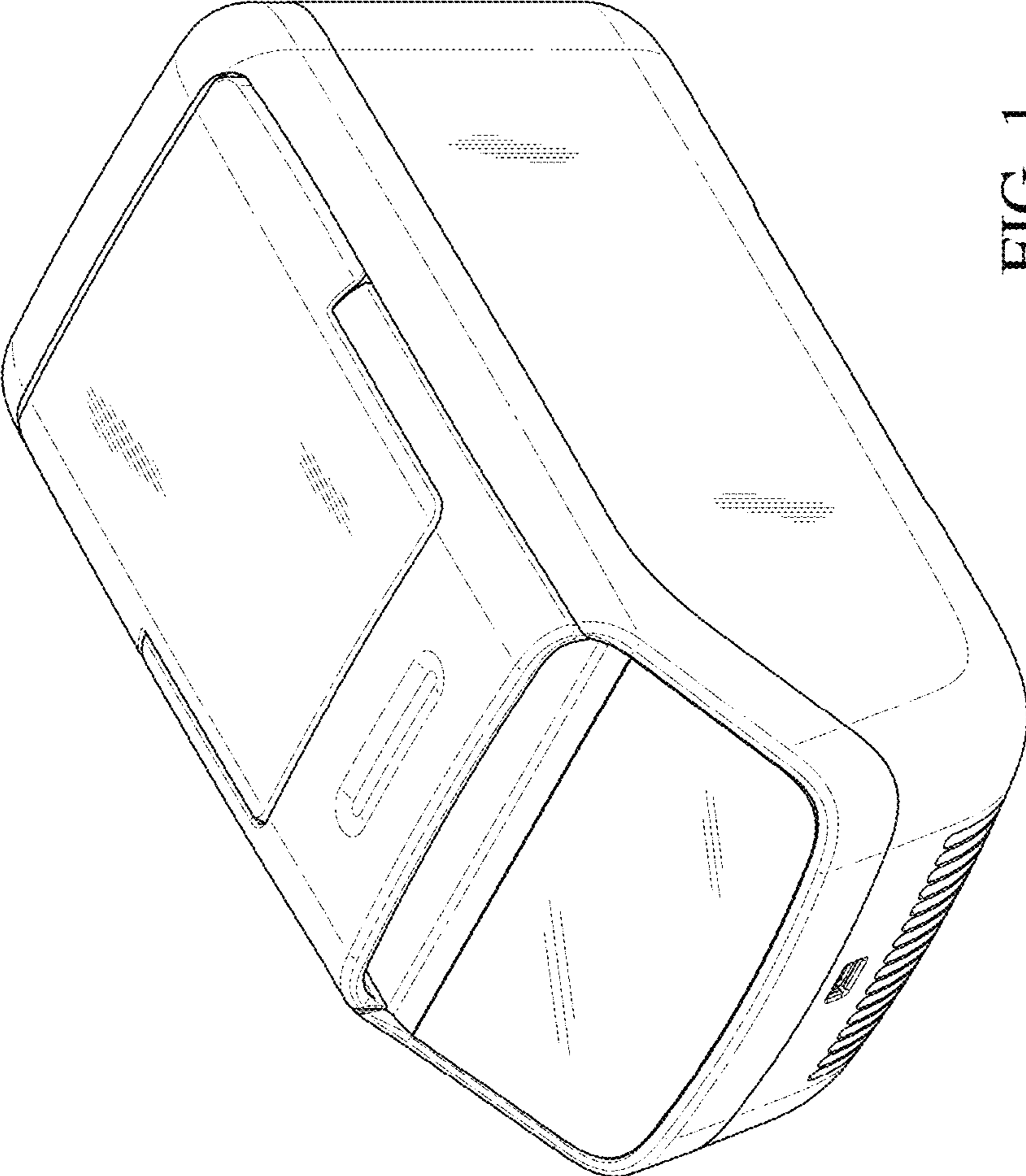

FIG. 1

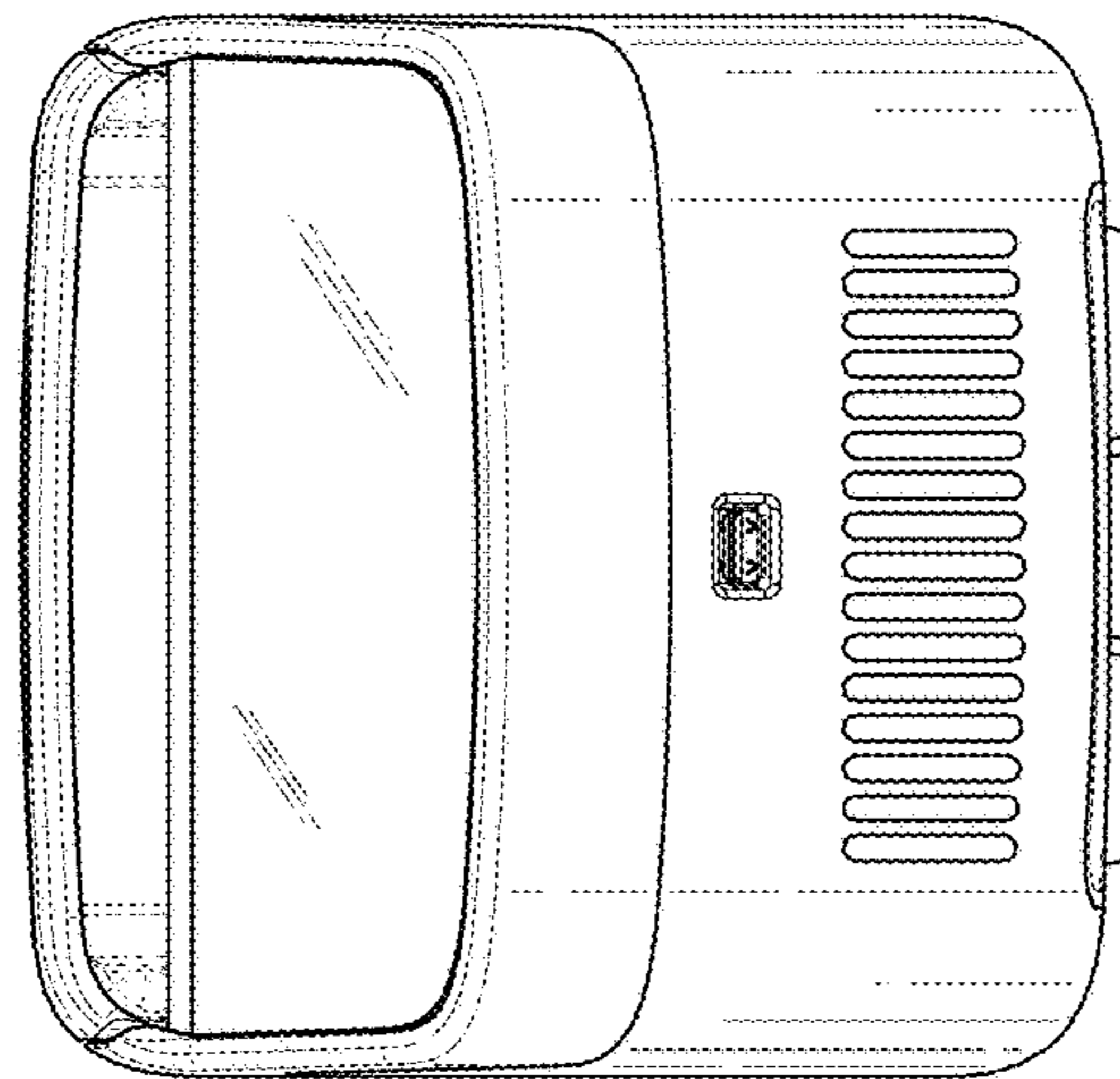

FIG. 2

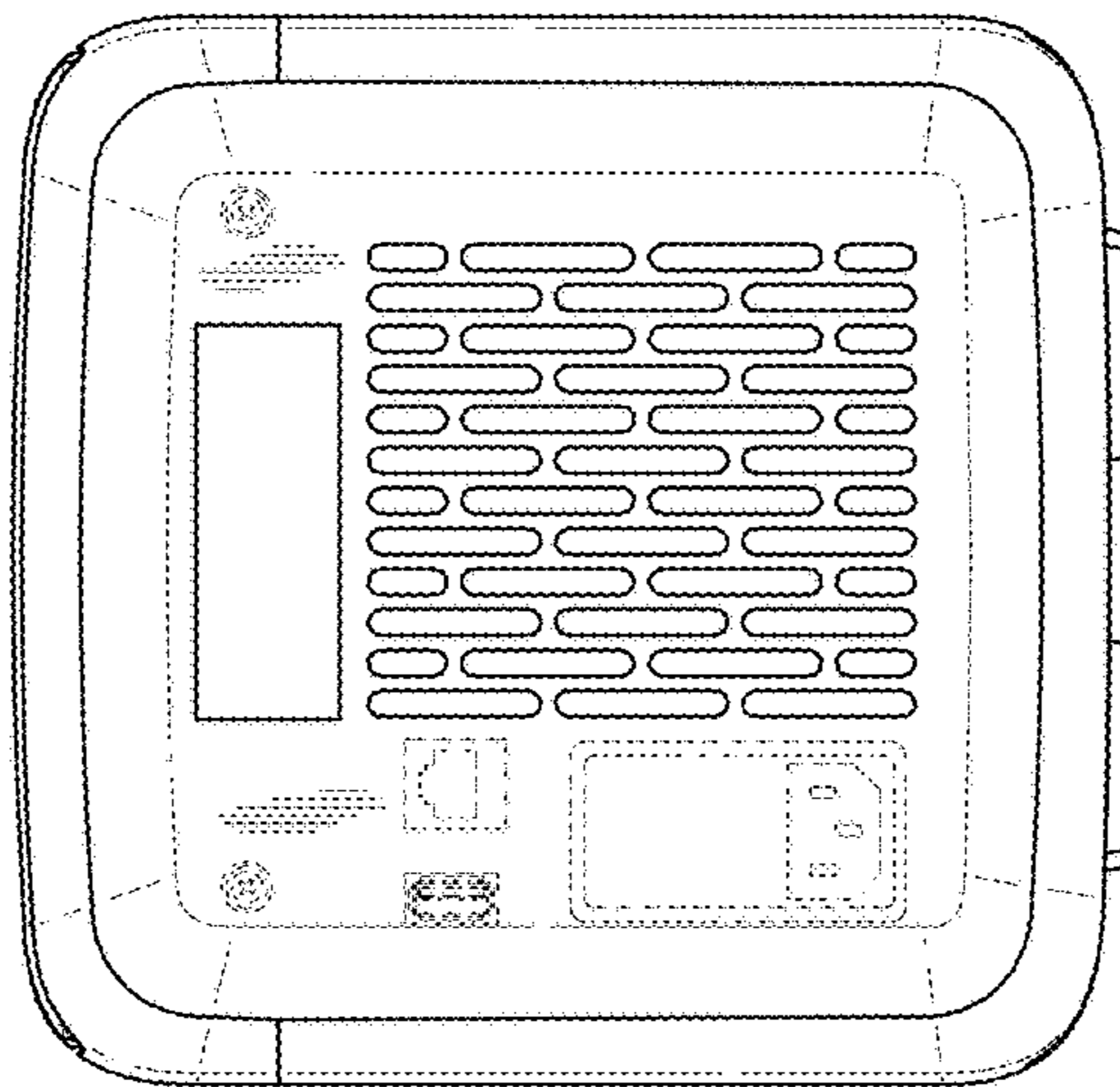

FIG. 3

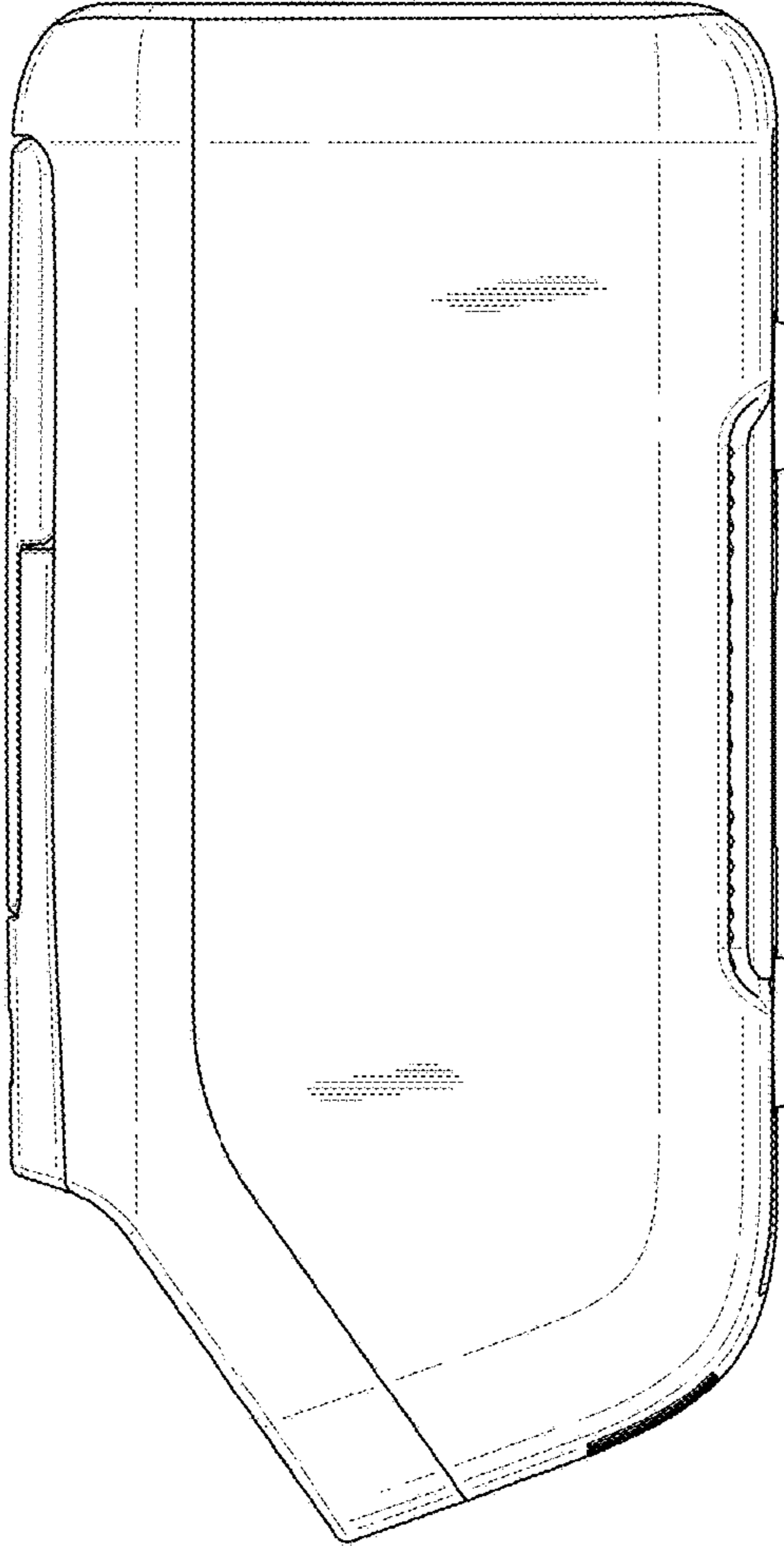

FIG. 4

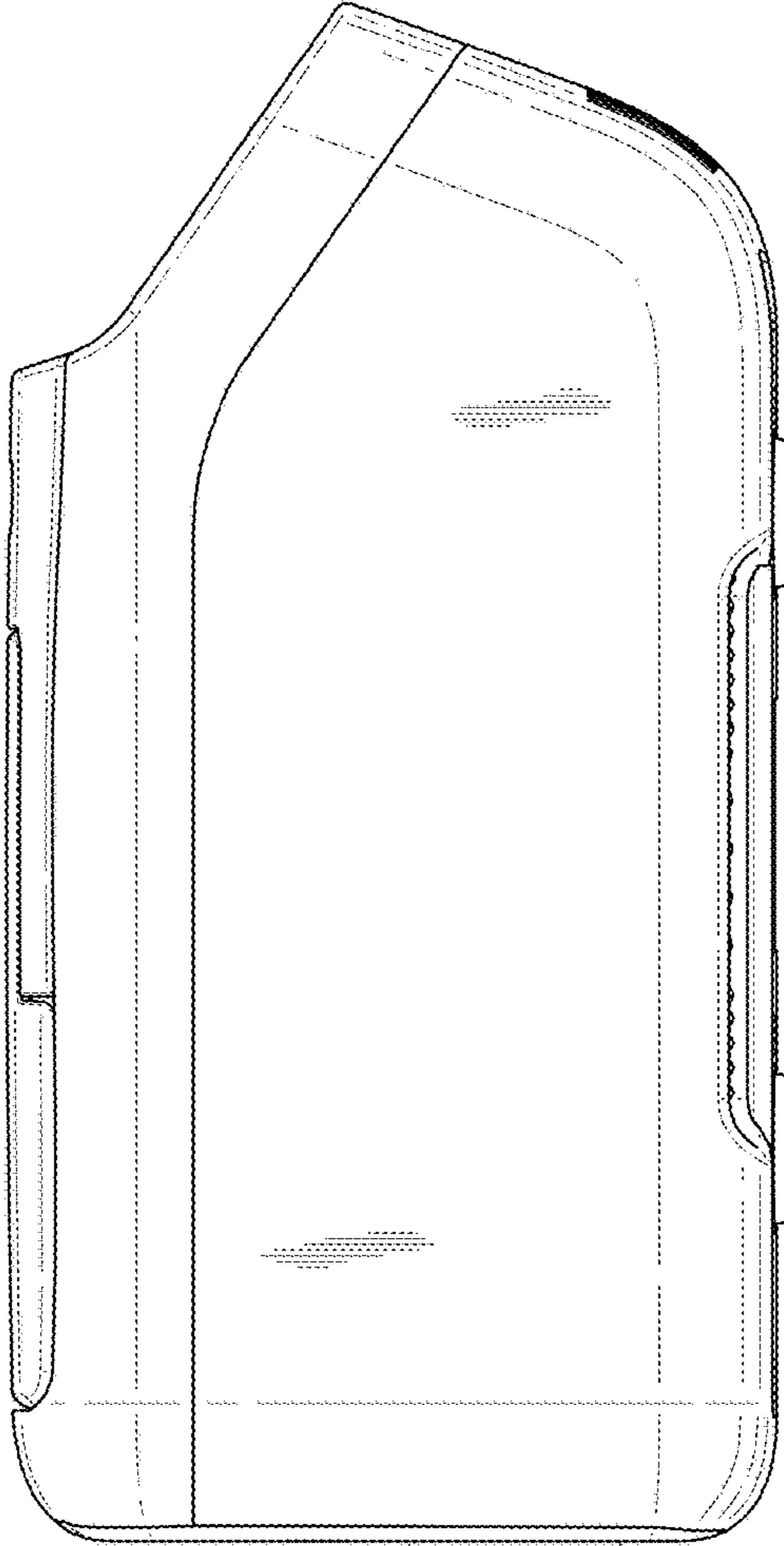

FIG. 5

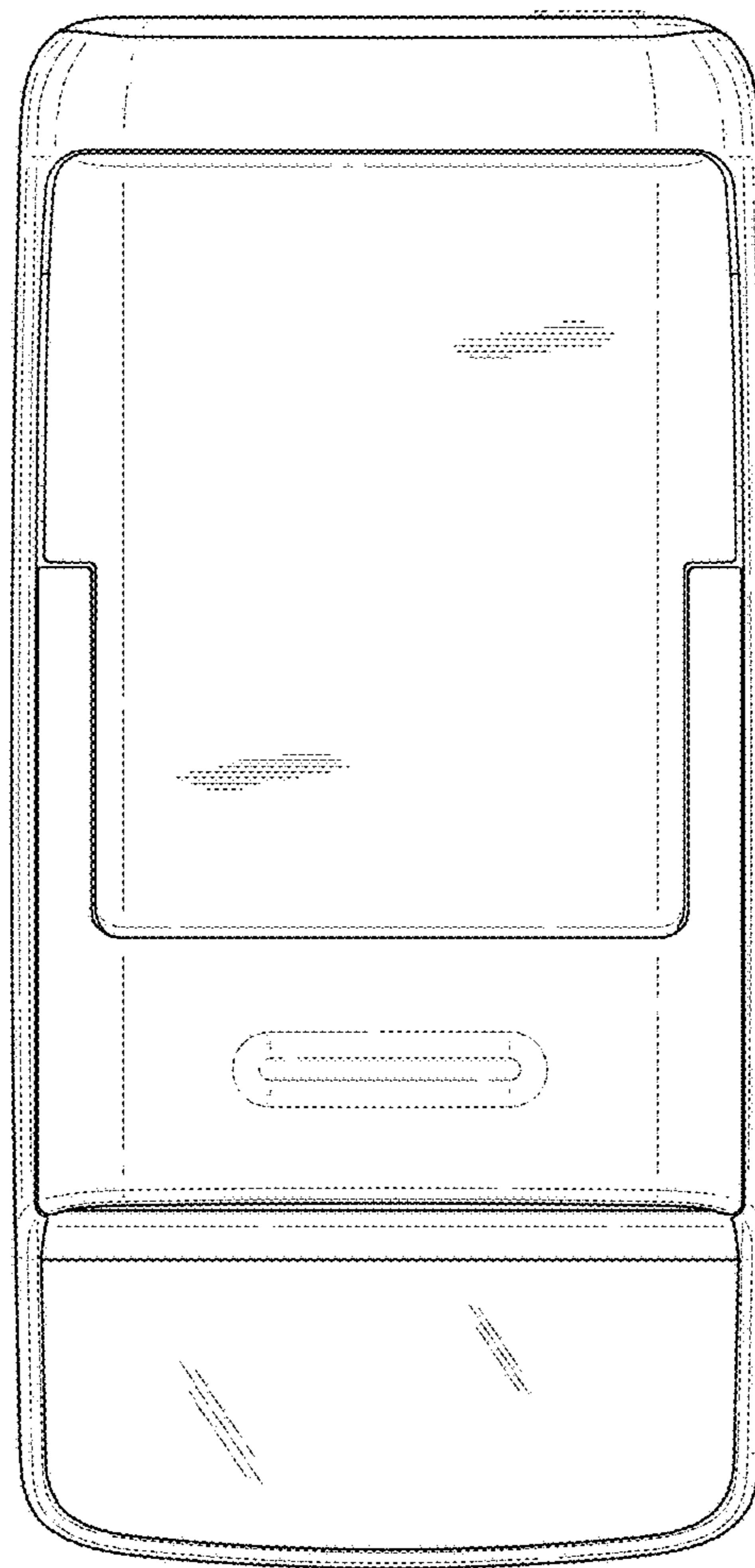

FIG. 6

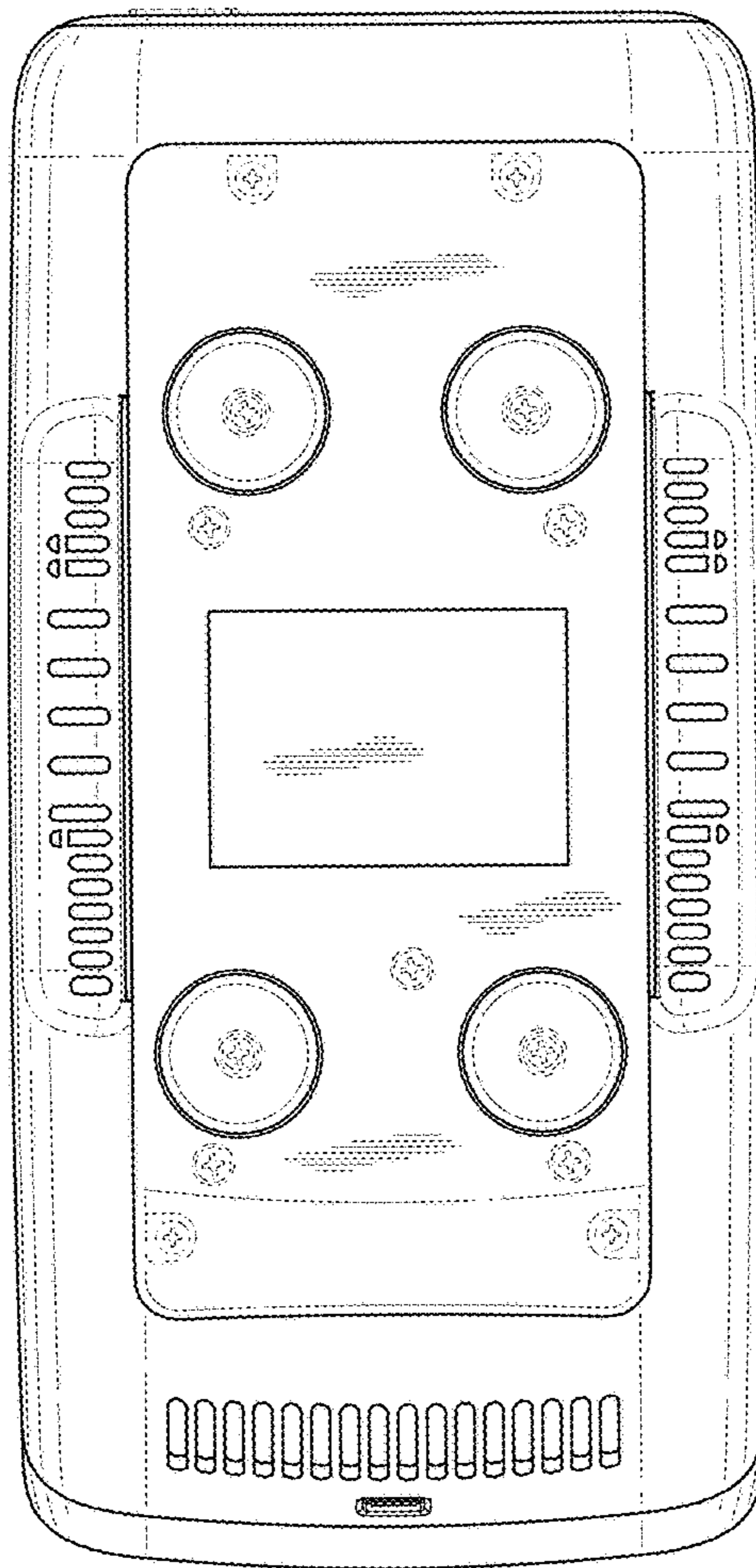

FIG. 7

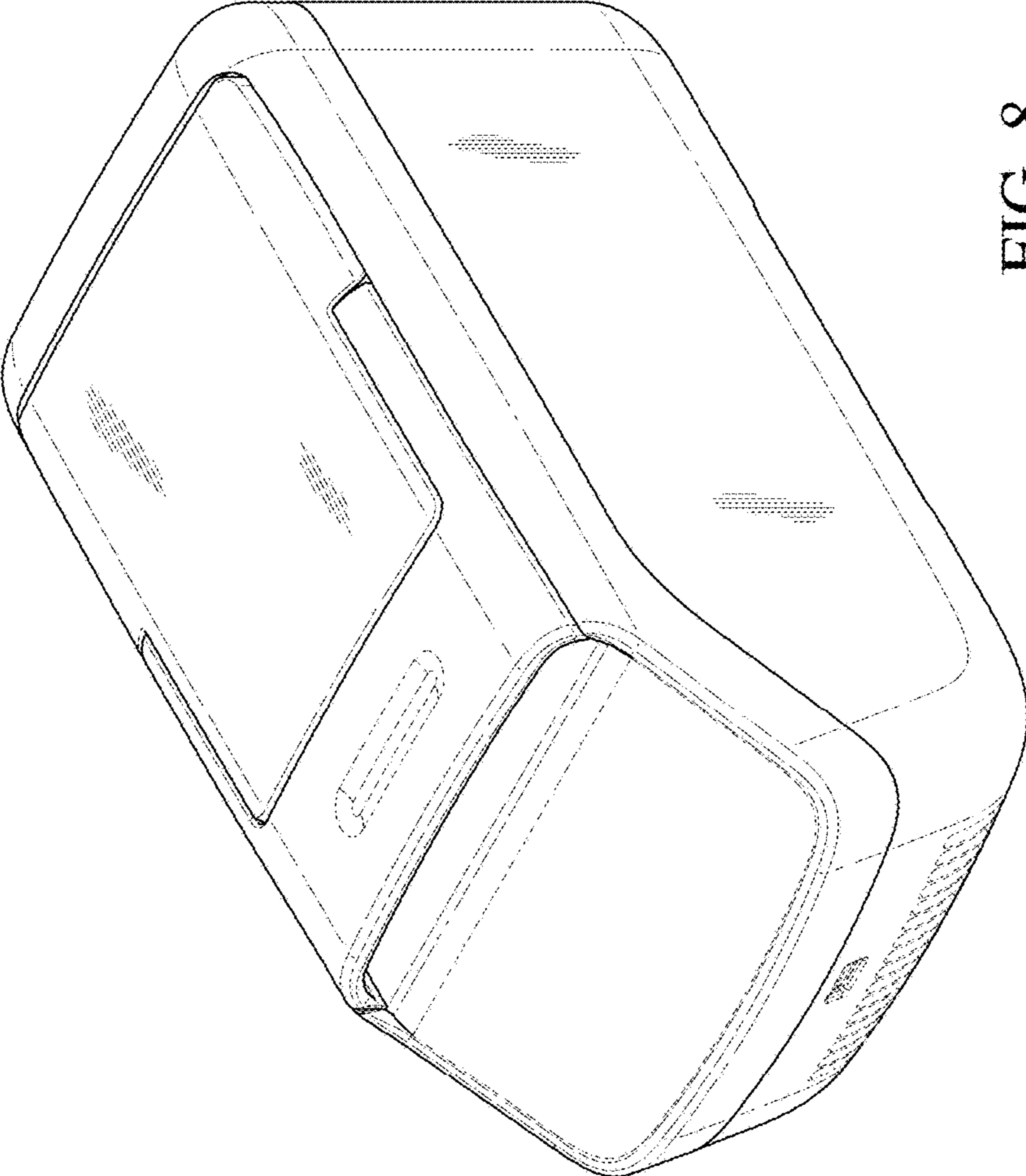

FIG. 8

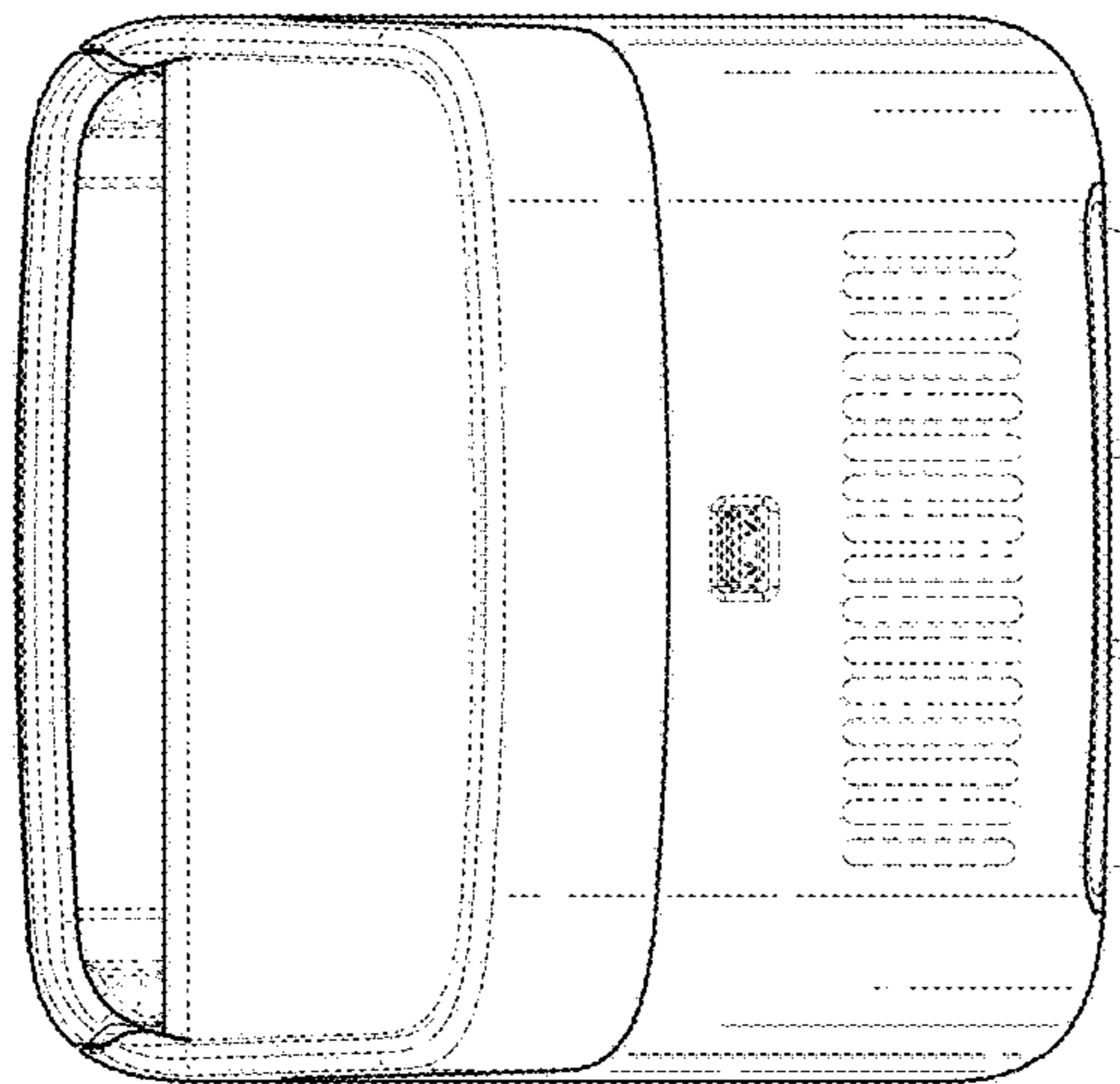

FIG. 9

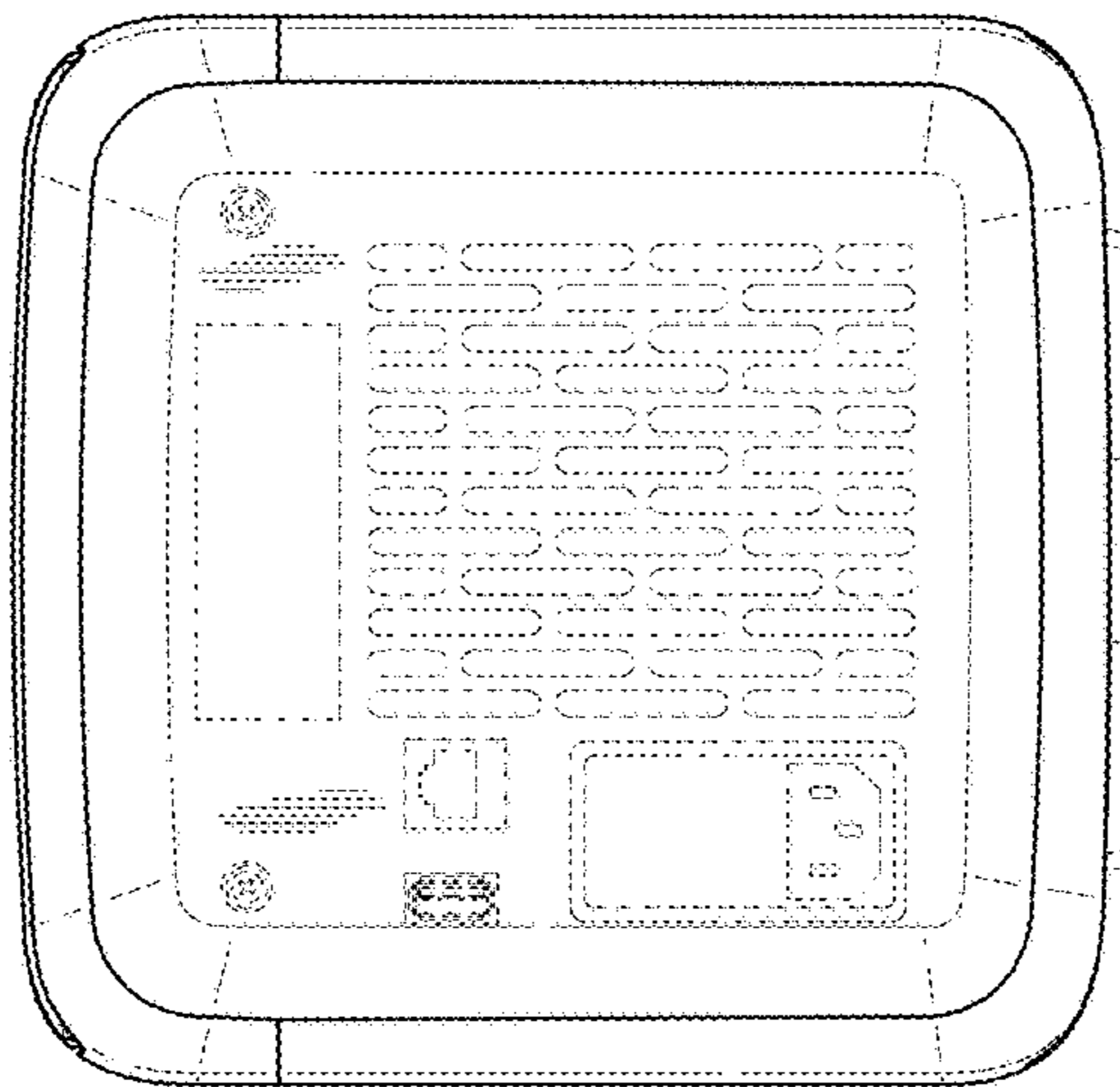

FIG. 10

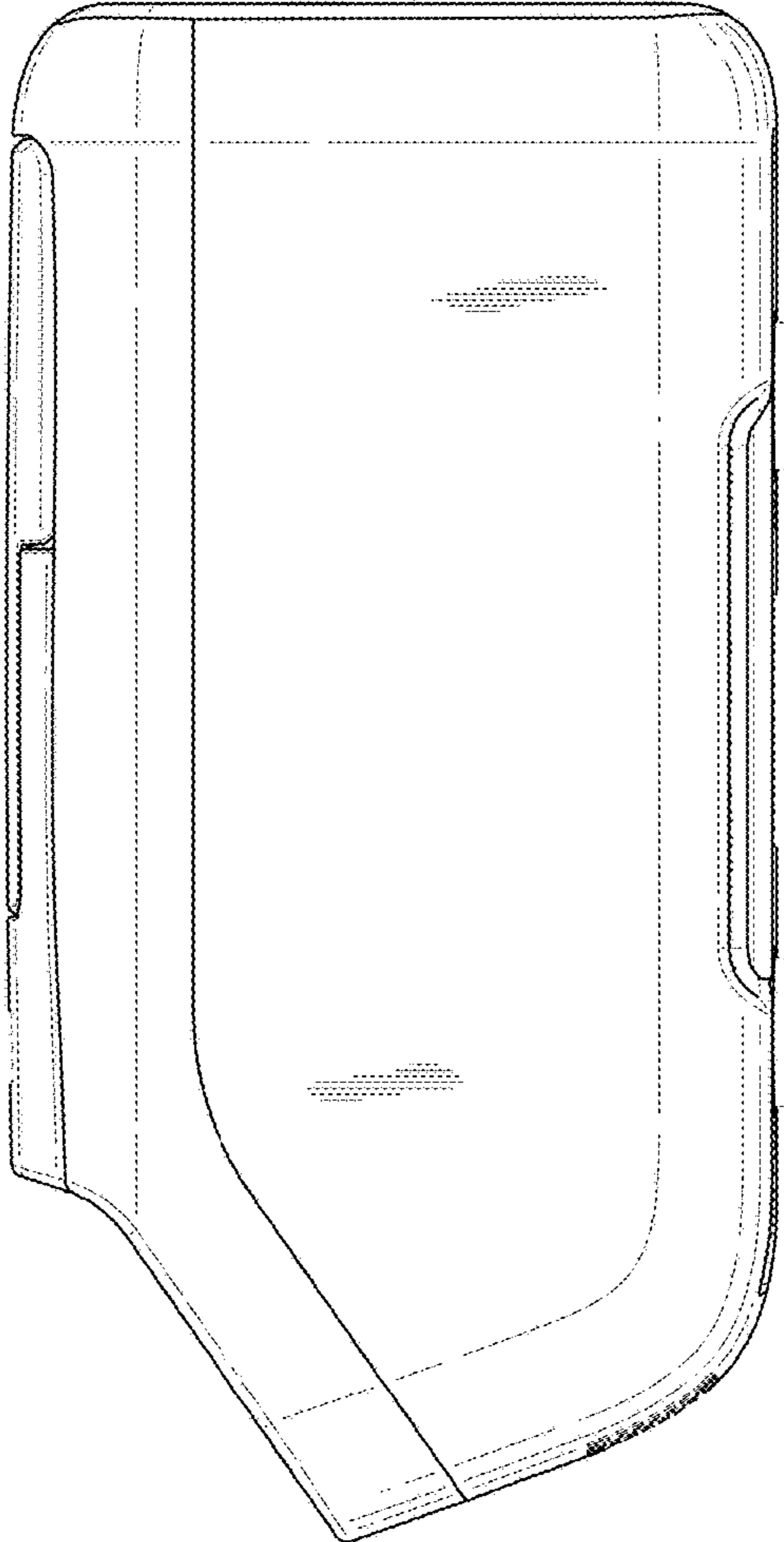

FIG. 11

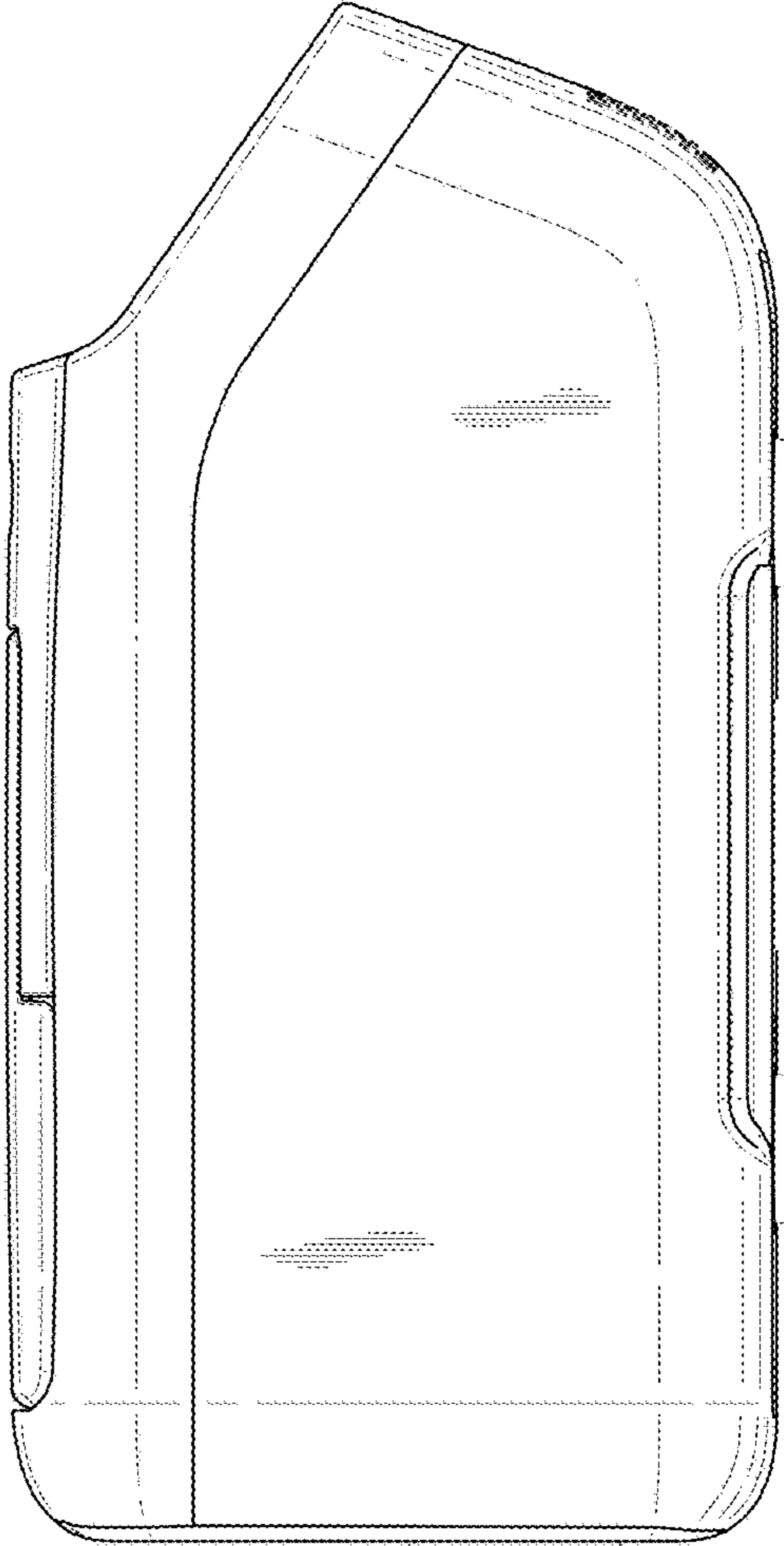

FIG. 12

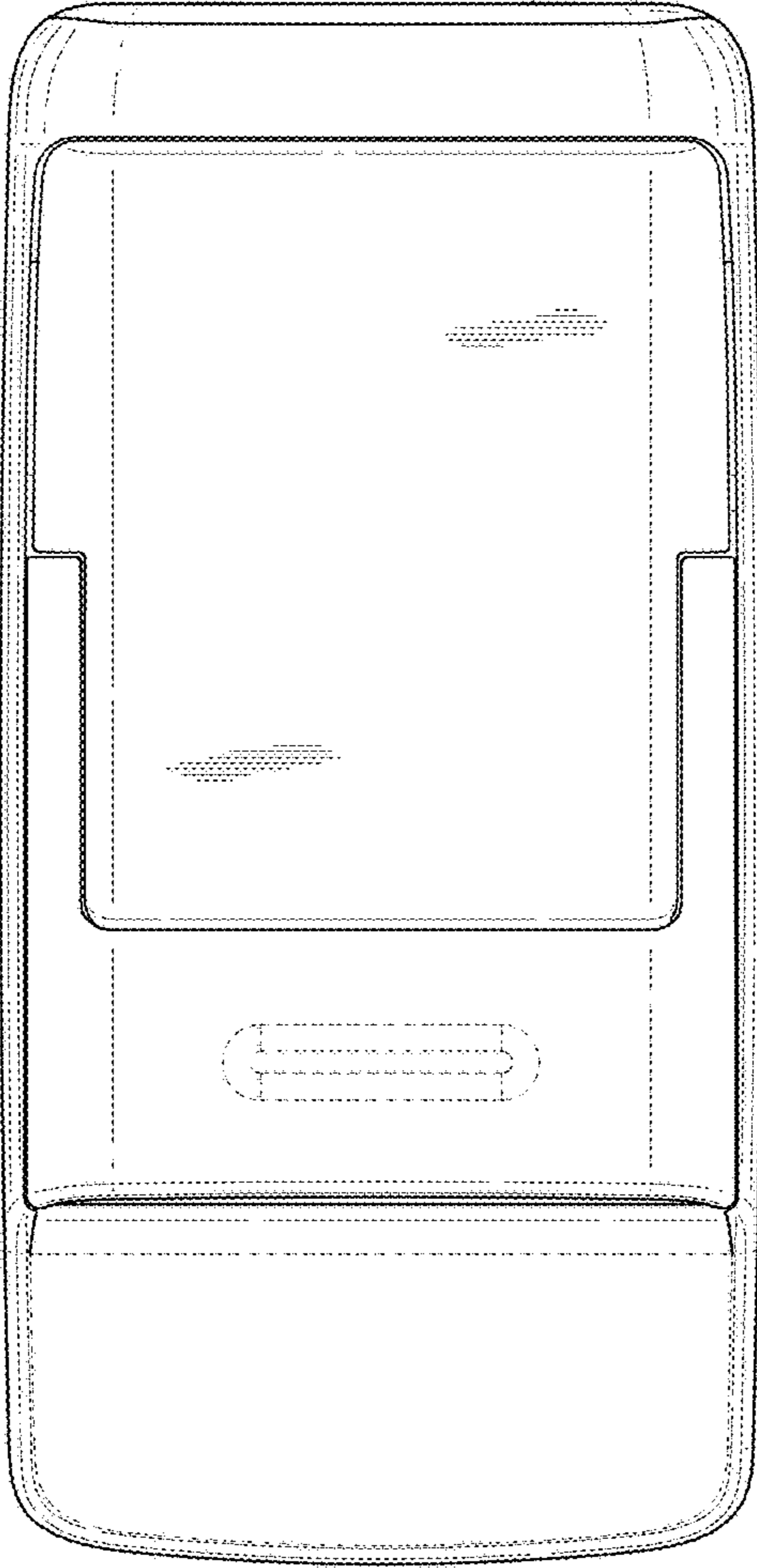

FIG. 13

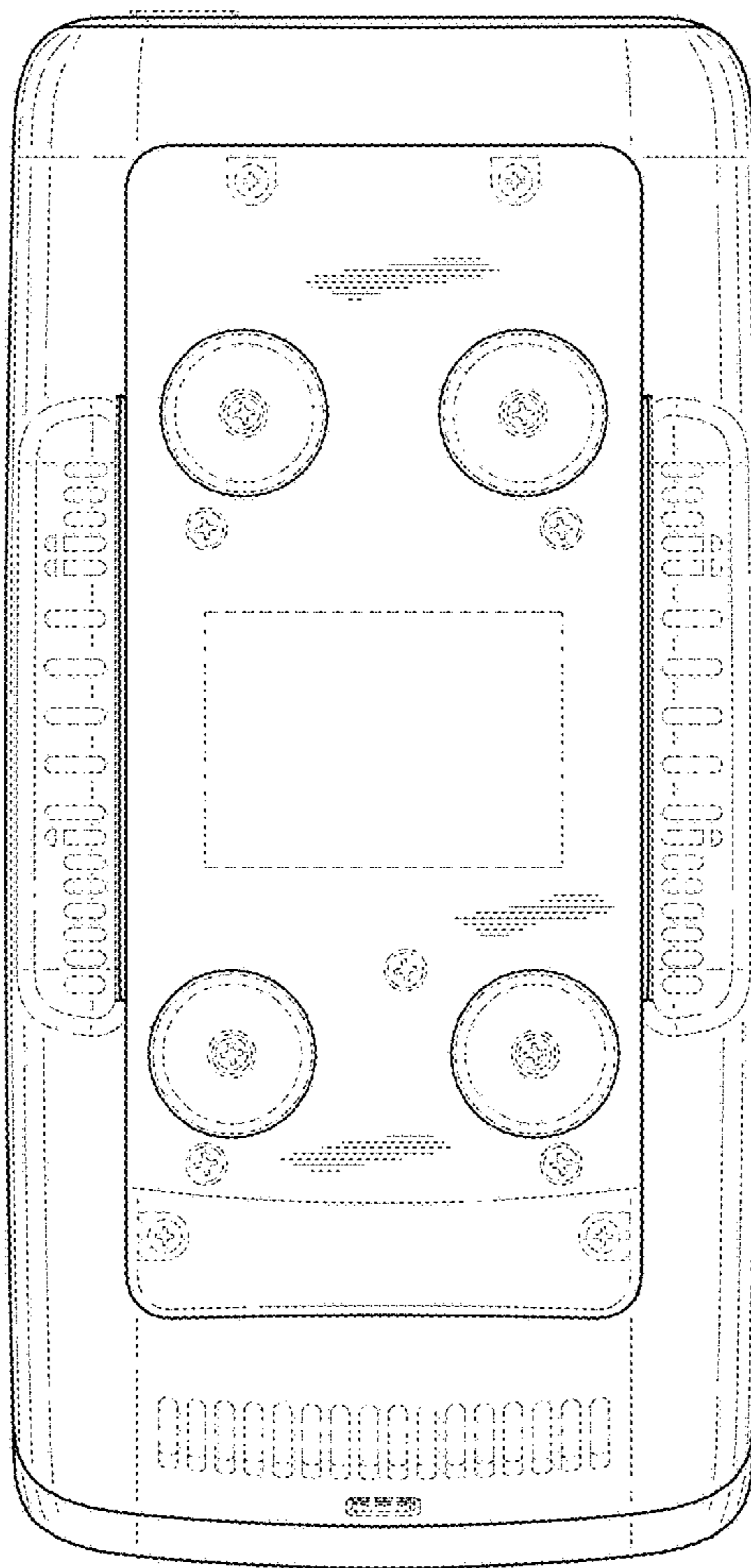

FIG. 14