



US00D865209S

(12) **United States Design Patent**
Nichols

(10) **Patent No.:** **US D865,209 S**

(45) **Date of Patent:** **** Oct. 29, 2019**

(54) **SKIN CARE DEVICE WITH CAMERA**

(71) Applicant: **Thomas Nichols**, Laguna Niguel, CA
(US)

(72) Inventor: **Thomas Nichols**, Laguna Niguel, CA
(US)

(**) Term: **15 Years**

(21) Appl. No.: **29/597,385**

(22) Filed: **Mar. 16, 2017**

(51) **LOC (12) Cl.** **28-03**

(52) **U.S. Cl.**

USPC **D24/214**; D16/208

(58) **Field of Classification Search**

USPC D24/200, 211, 212, 213, 214, 215, 133,
D24/137, 150, 151, 157, 158; 601/19,
601/22, 40, 46, 52, 63, 99, 110–113,
601/118–120, 125, DIG. 12, DIG. 14,
601/DIG. 15, DIG. 16, DIG. 17;
D16/130, 208, 237; D4/102
CPC A61H 1/00; A61H 2015/0007; A61H
2015/0014; A61H 2015/0042; A61H
15/00; A61H 11/00; A61H 21/00; A61H
37/00

See application file for complete search history.

(56) **References Cited**

U.S. PATENT DOCUMENTS

D445,817 S * 7/2001 Okuley D16/202
D540,838 S * 4/2007 Aronsson D16/206

D589,650 S * 3/2009 Adriaenssen D24/133
D649,636 S * 11/2011 Bean D24/133
D675,829 S * 2/2013 Jakubow D4/102
D742,003 S * 10/2015 Tasar D24/146
D747,800 S * 1/2016 Dunleavy D24/133
D780,245 S * 2/2017 Ruback D16/206
D795,423 S * 8/2017 Chen D24/133
D805,571 S * 12/2017 Hogstedt D16/206
D805,572 S * 12/2017 Hogstedt D16/206
D848,013 S * 5/2019 Fuhner D24/215

* cited by examiner

Primary Examiner — Sandra S Snapp

(74) *Attorney, Agent, or Firm* — Knobbe Martens Olson
& Bear LLP

(57) **CLAIM**

I claim the ornamental design for a skin care device with camera, as shown and described.

DESCRIPTION

FIG. 1 is a front, right side perspective view of a skin care device with camera embodying our design;
FIG. 2 is a front elevation view thereof;
FIG. 3 is a rear elevation view thereof;
FIG. 4 is a left side elevation view thereof;
FIG. 5 is a right side elevation view thereof;
FIG. 6 is a top plan view thereof;
FIG. 7 is a bottom plan view thereof; and,
FIG. 8 is a front, right side exploded perspective view thereof.

The broken lines shown in the figures represent portions of the skin care device with camera that form no part of the claimed design.

1 Claim, 8 Drawing Sheets

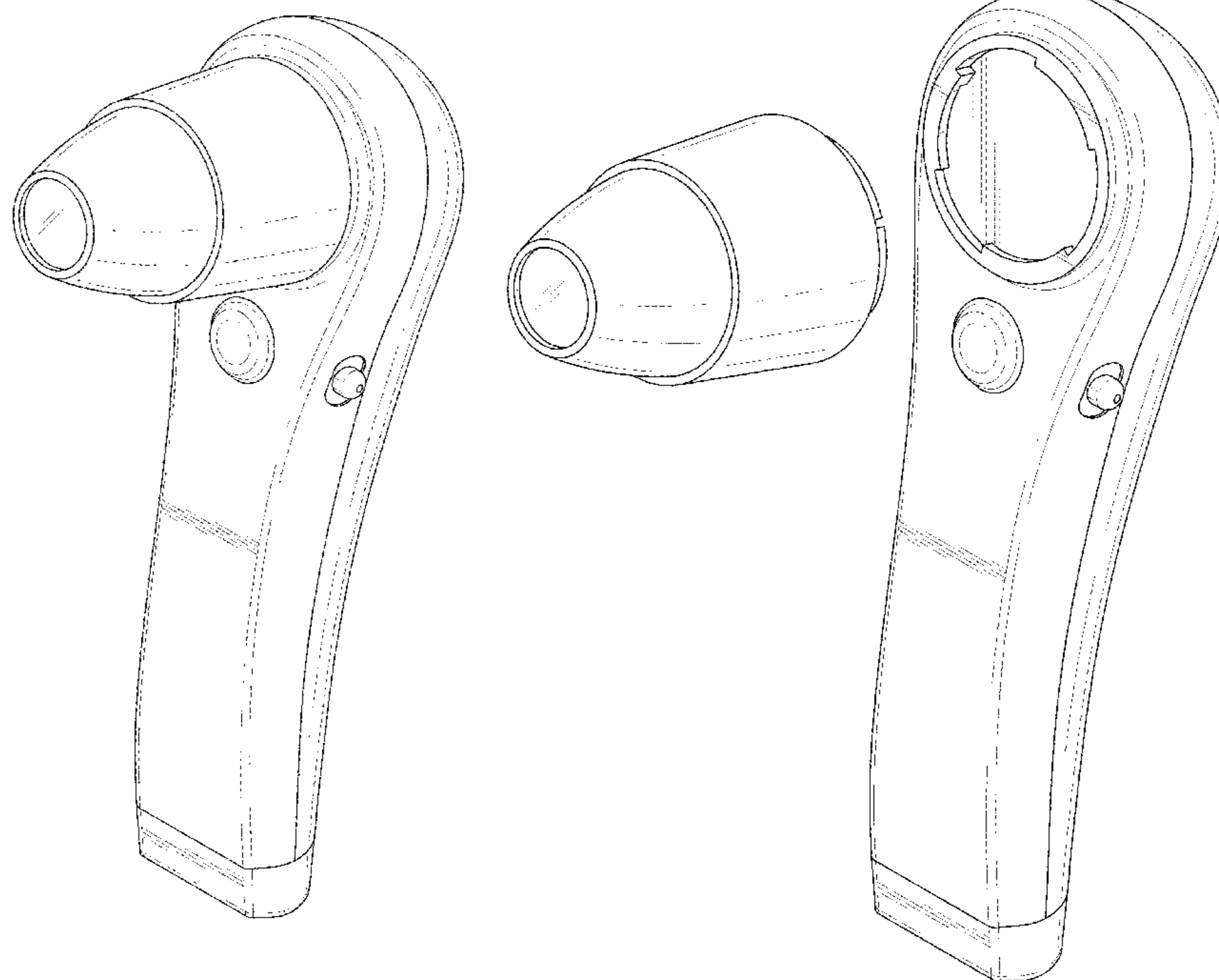

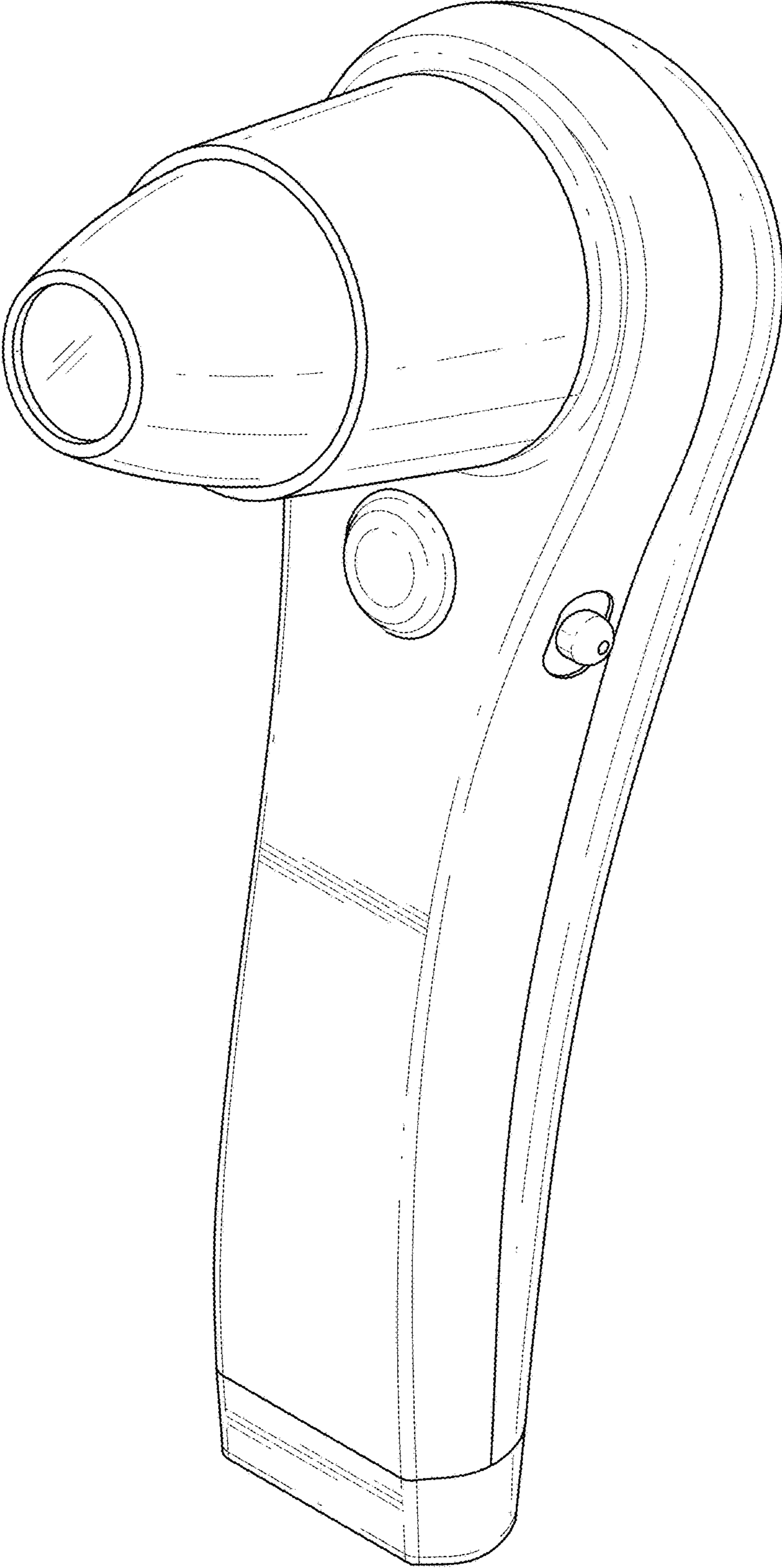

FIG. 1

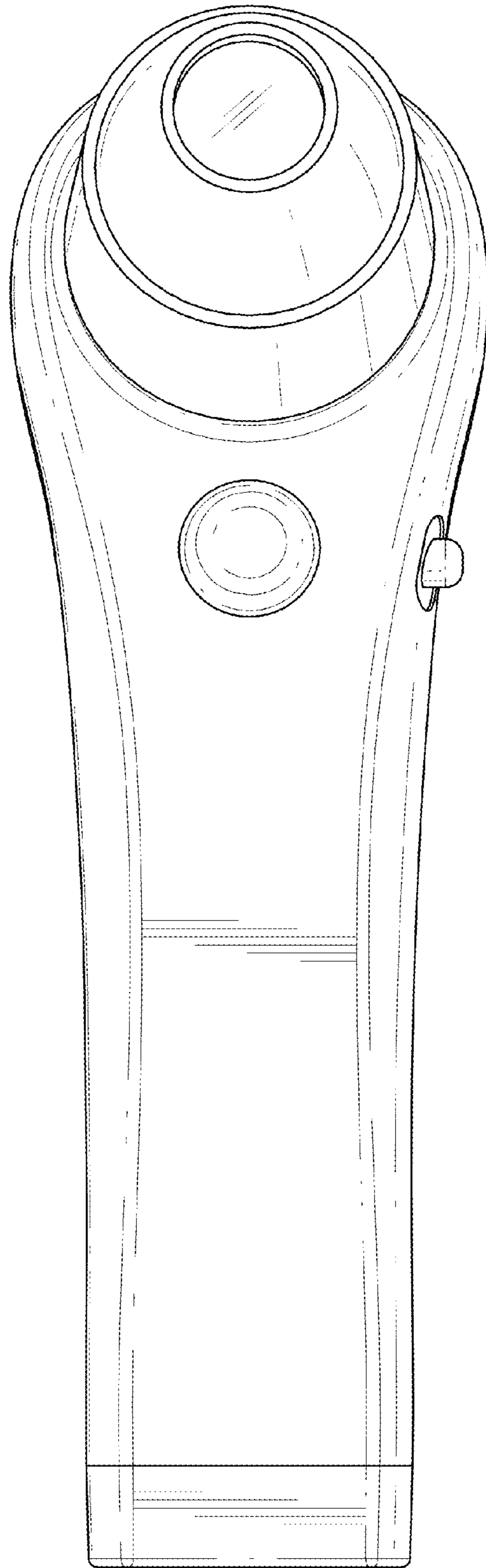

FIG. 2

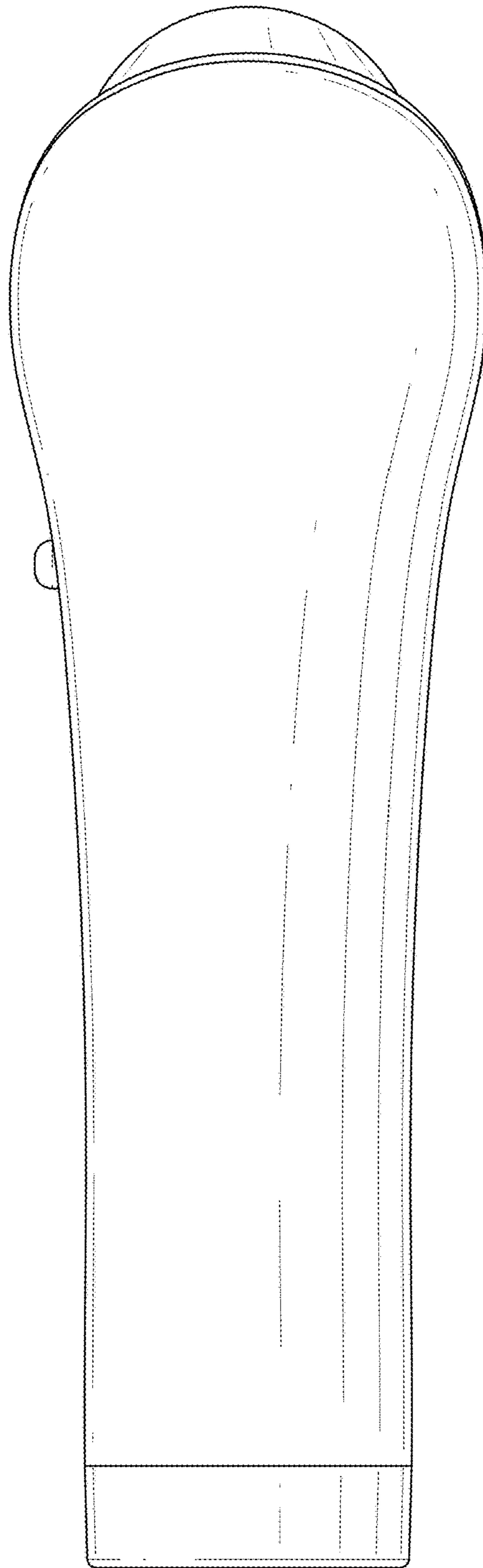

FIG. 3

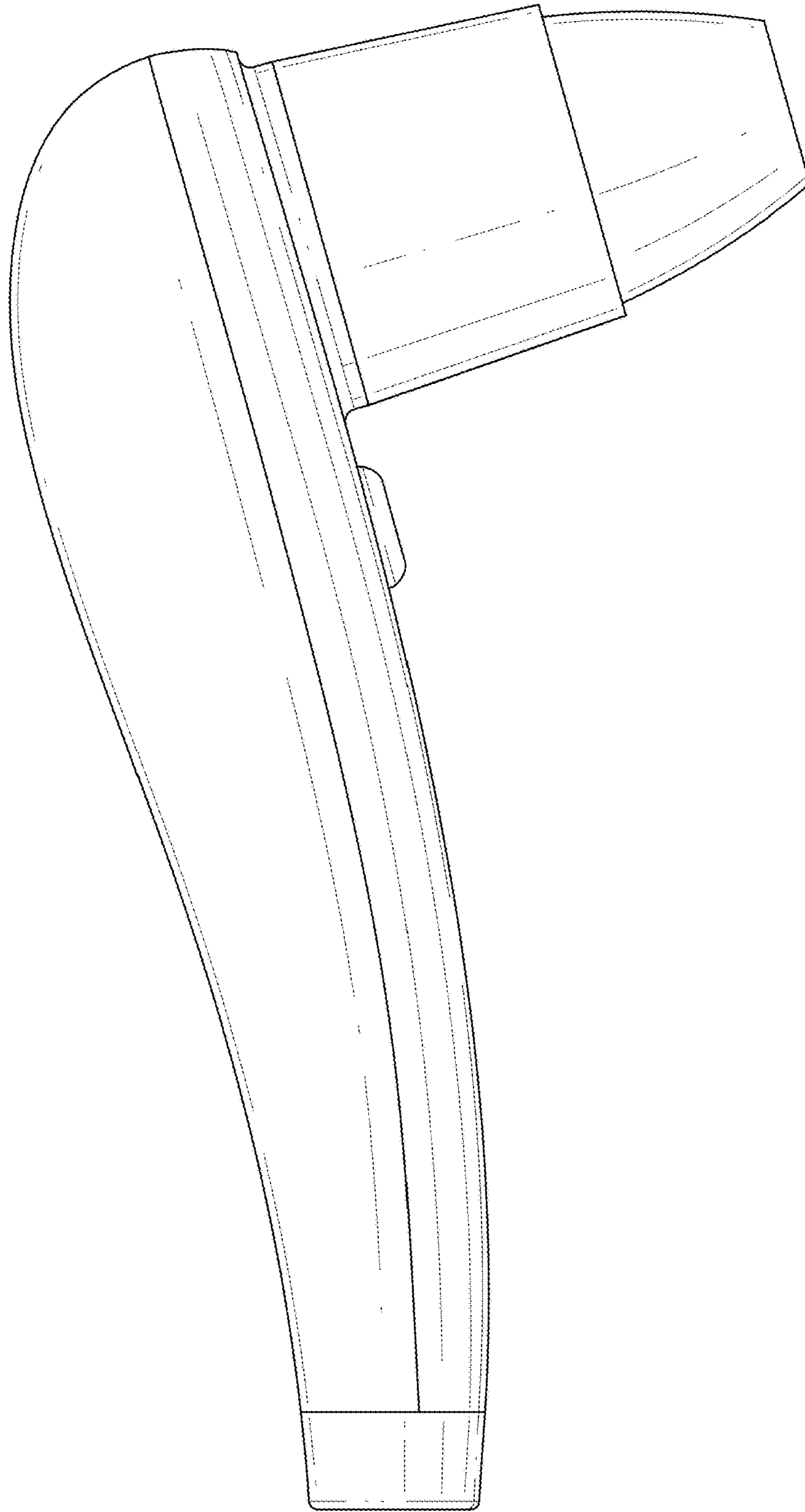

FIG. 4

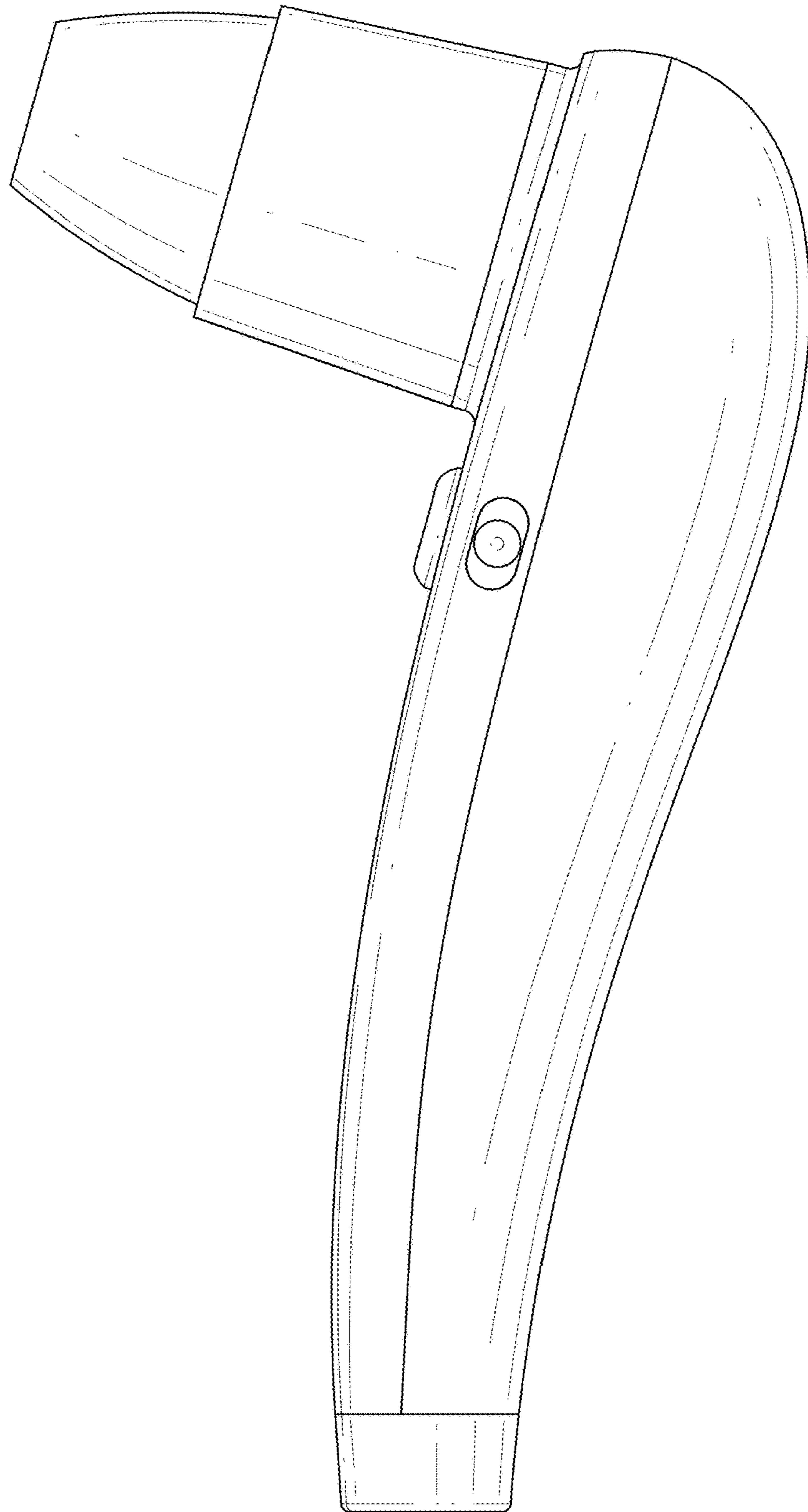

FIG. 5

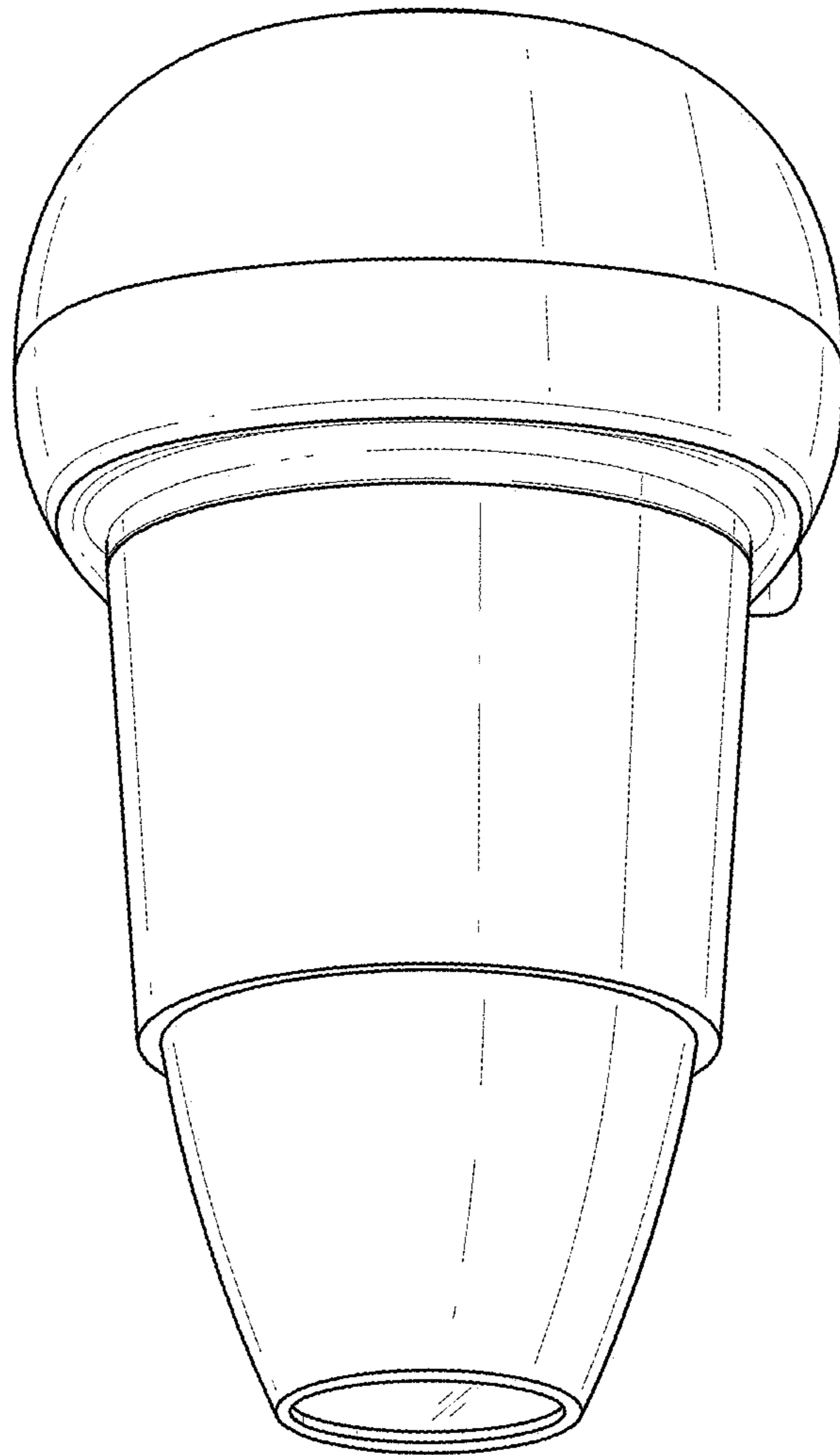

FIG. 6

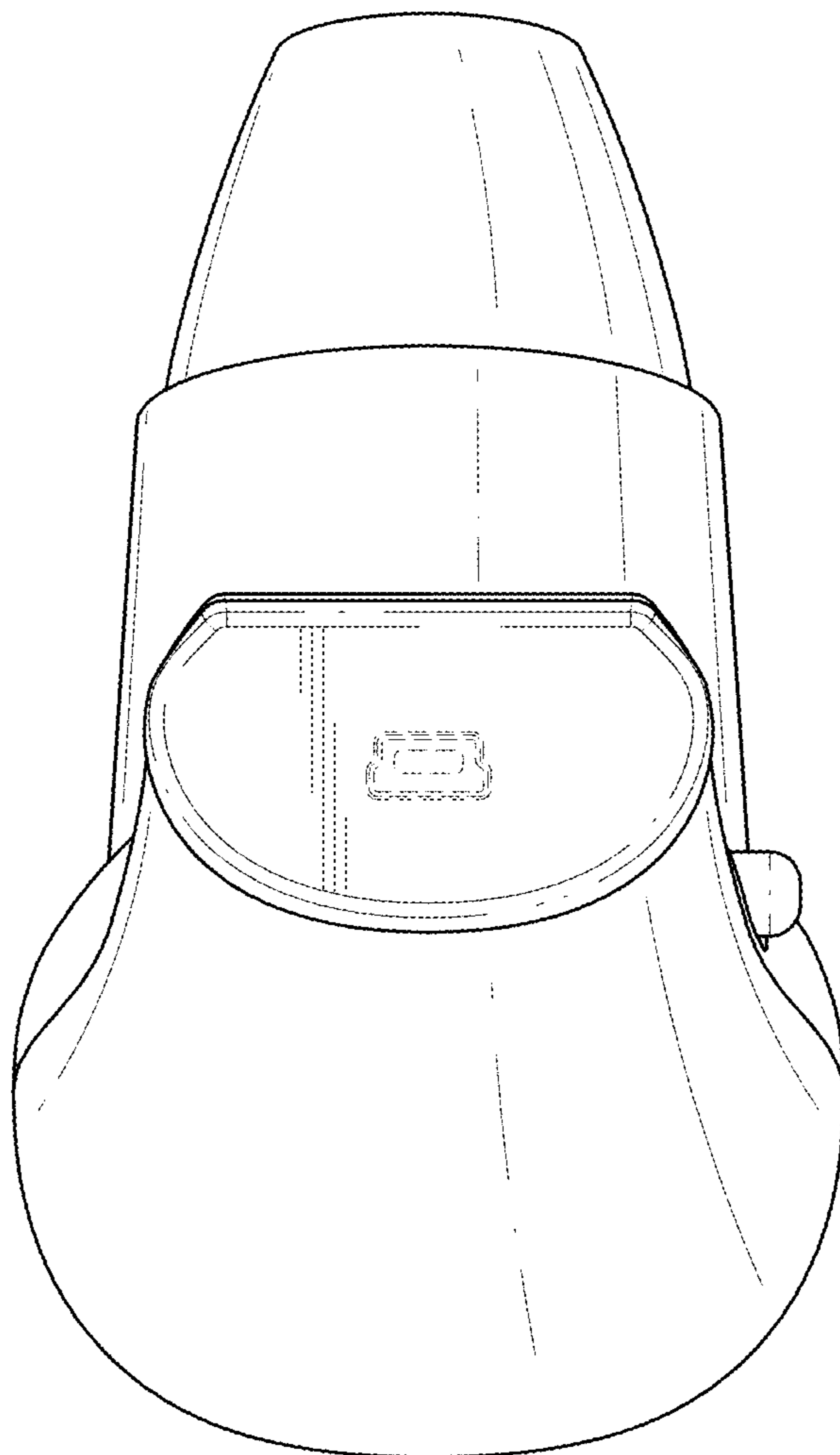

FIG. 7

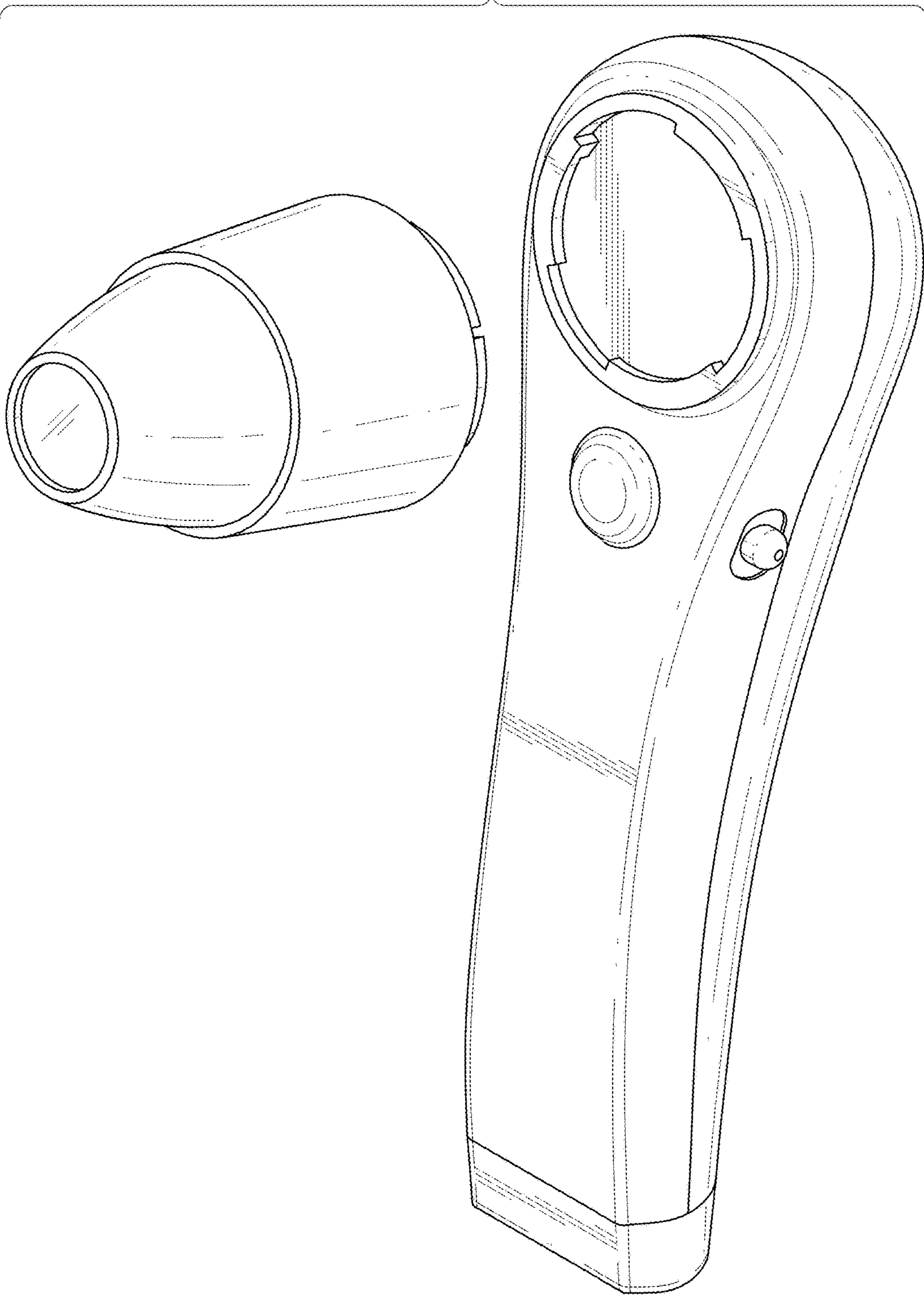

FIG. 8