

US00D865171S

(12) **United States Design Patent** (10) **Patent No.:** **US D865,171 S**  
**Tajima** (45) **Date of Patent:** **\*\* Oct. 29, 2019**

(54) **INDUSTRIAL ENDOSCOPE**  
(71) Applicant: **OLYMPUS CORPORATION**, Tokyo (JP)  
(72) Inventor: **Kenji Tajima**, Hachioji (JP)  
(73) Assignee: **OLYMPUS CORPORATION**, Tokyo (JP)

D705,424 S \* 5/2014 Yarbrough ..... D24/144  
D723,684 S \* 3/2015 Funakoshi ..... D24/138  
D755,379 S \* 5/2016 Amano ..... D24/138  
D762,853 S \* 8/2016 Amano ..... D24/138  
D780,917 S \* 3/2017 Meguro ..... D24/138  
D782,673 S \* 3/2017 Meguro ..... D24/138  
D803,387 S \* 11/2017 Bodwell ..... D24/108  
2013/0079594 A1 \* 3/2013 Motoki ..... A61B 1/00039  
600/109

(\*\*) Term: **15 Years**

\* cited by examiner

(21) Appl. No.: **29/649,272**

*Primary Examiner* — Eliza Z Bennett-Hattan

(22) Filed: **May 29, 2018**

(74) *Attorney, Agent, or Firm* — Scully, Scott, Murphy & Presser, P.C.

(30) **Foreign Application Priority Data**

(57) **CLAIM**

Nov. 29, 2017 (JP) ..... 2017-026514

The ornamental design for an industrial endoscope, as shown and described.

(51) **LOC (12) Cl.** ..... **24-02**

(52) **U.S. Cl.**  
USPC ..... **D24/138**

**DESCRIPTION**

(58) **Field of Classification Search**  
USPC ..... D24/138, 137, 147, 144, 108, 113, 127,  
D24/133; D14/203.1  
CPC ..... G02B 23/2476; G02B 23/26;  
G02B 23/2484; G02B 23/2492; G02B  
23/16; G02B 23/243; G02B 7/023  
See application file for complete search history.

FIG. 1 is a front perspective view of an industrial endoscope showing my new design;  
FIG. 2 is a rear perspective view thereof;  
FIG. 3 is a front view thereof;  
FIG. 4 is a rear view thereof;  
FIG. 5 is a top view thereof;  
FIG. 6 is a bottom view thereof;  
FIG. 7 is a right side view thereof; and,  
FIG. 8 is a left side view thereof.

(56) **References Cited**

The appearance of the industrial endoscope shown between the dot-dash break lines forms no part of the claimed design.

**U.S. PATENT DOCUMENTS**

D599,017 S \* 8/2009 Urushihata ..... D24/138  
D601,699 S \* 10/2009 Urushihata ..... D24/138

**1 Claim, 8 Drawing Sheets**

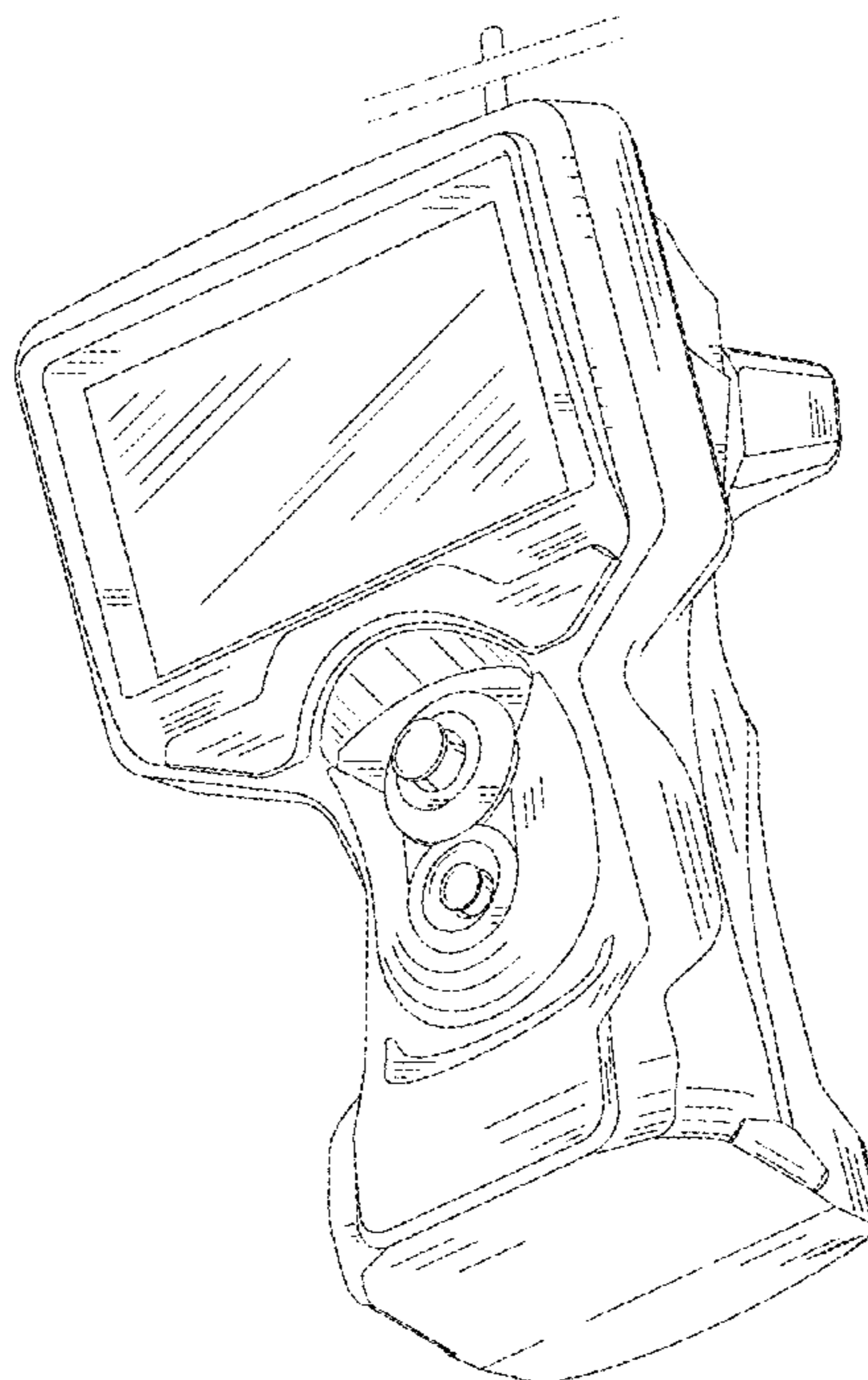

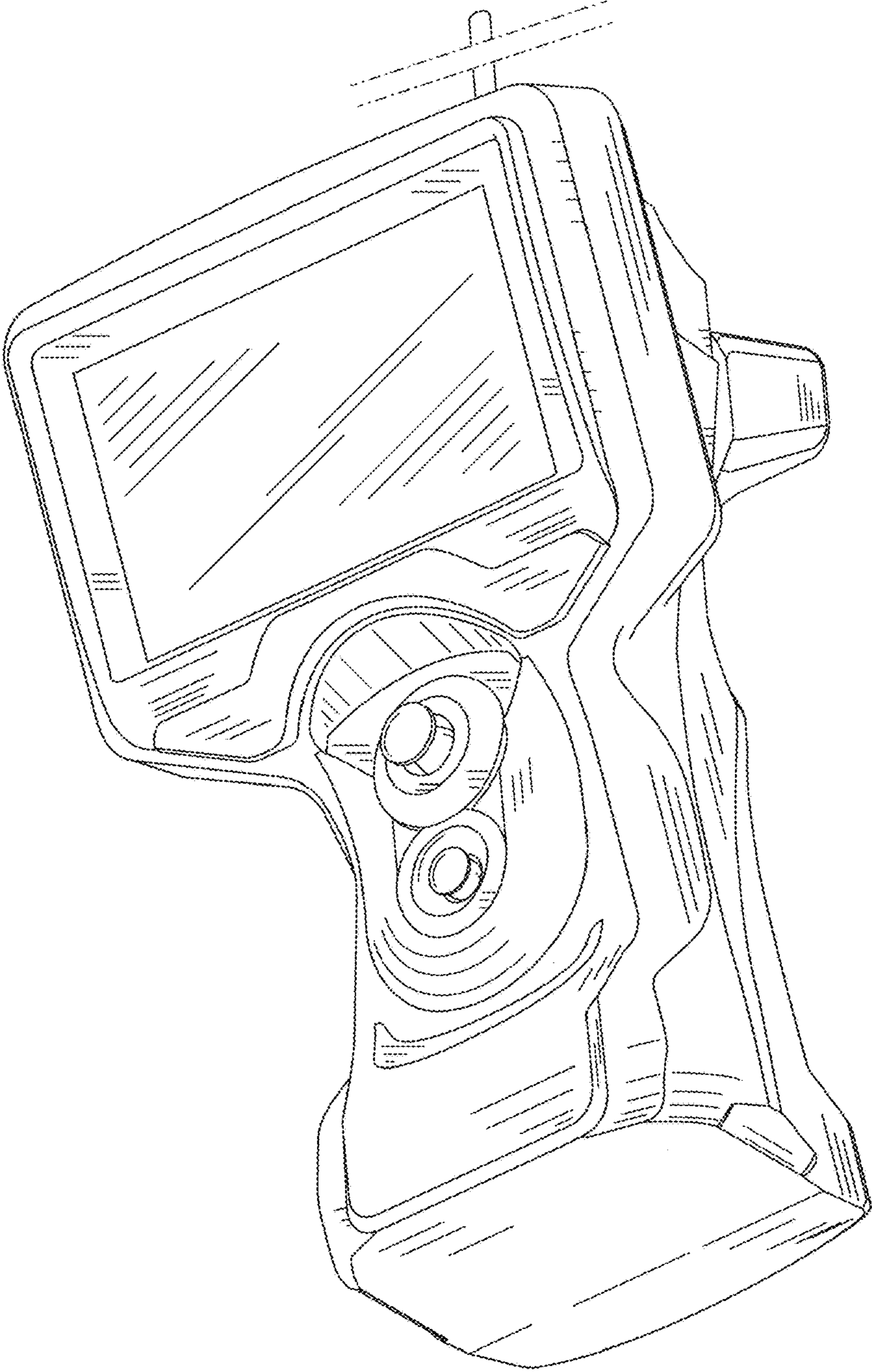

Fig. 1



Fig. 2



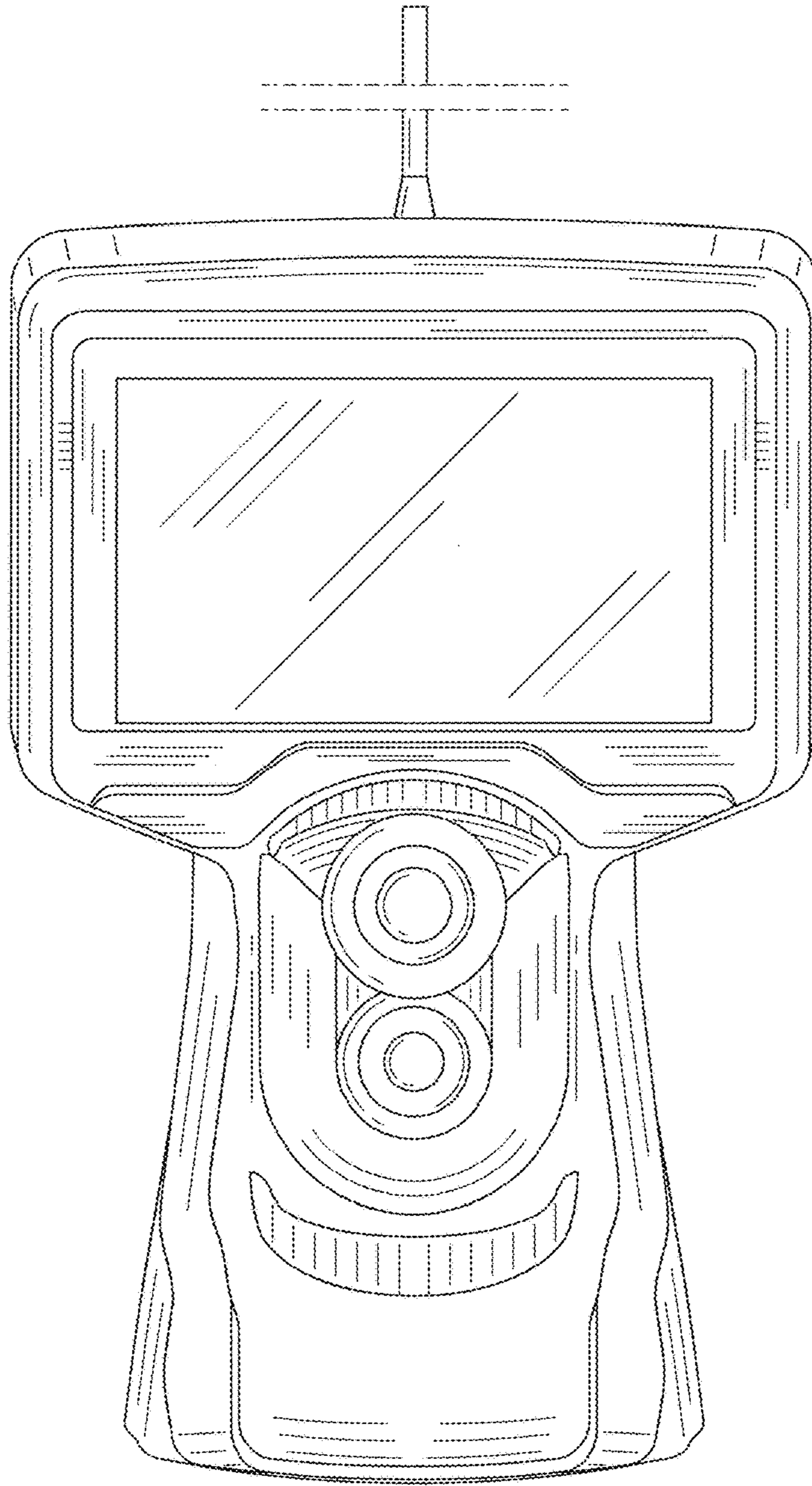

Fig. 3

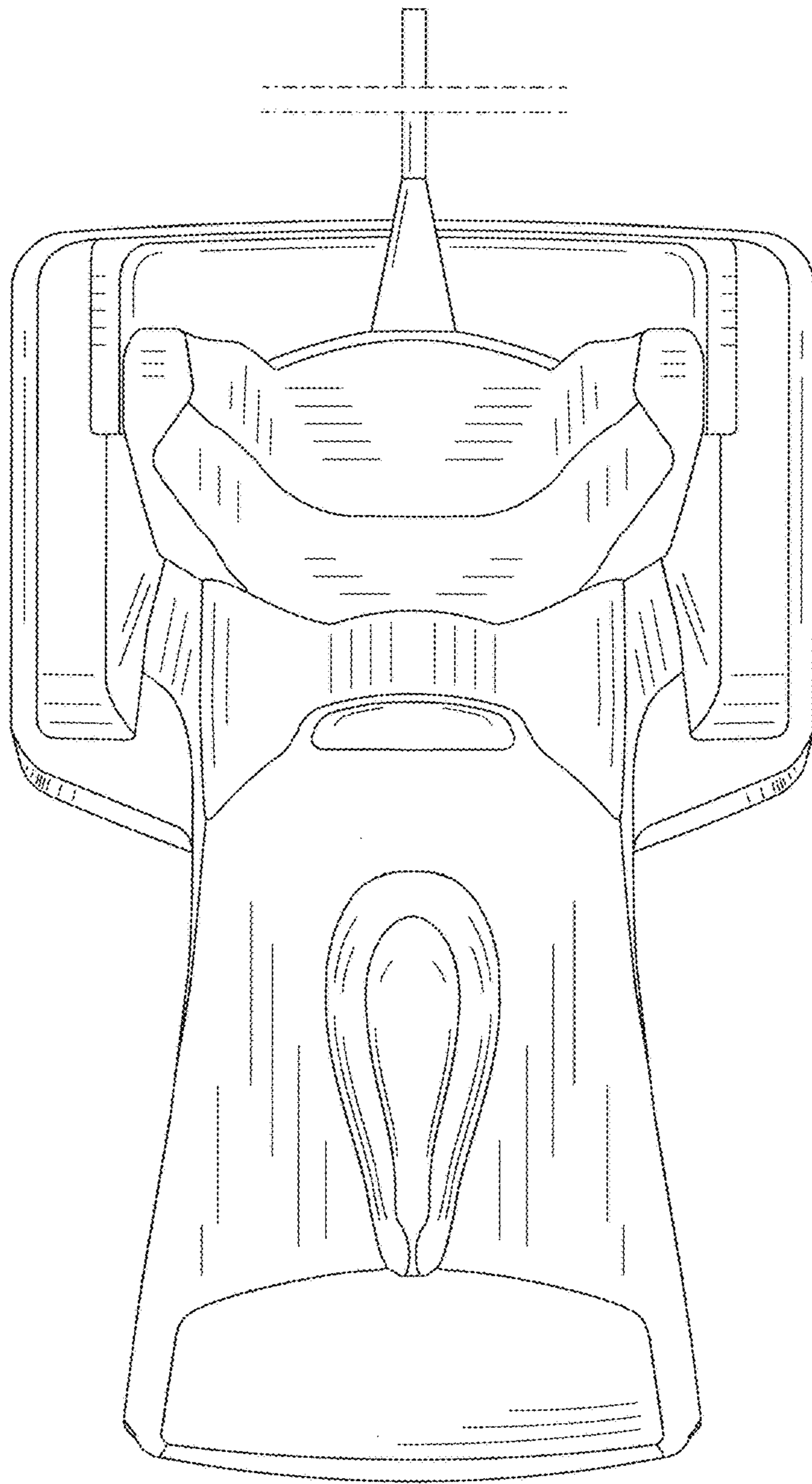

Fig. 4

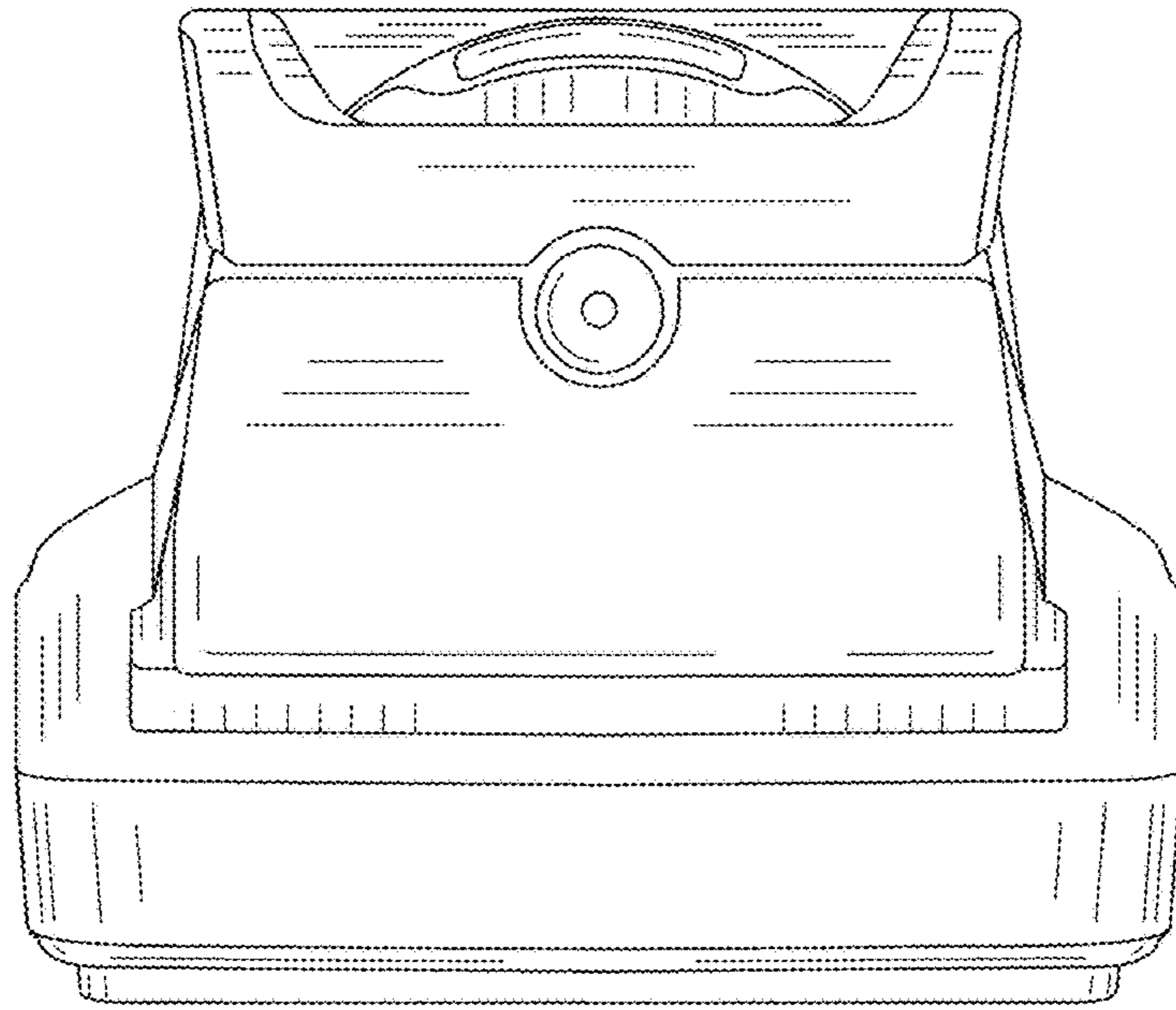

Fig. 5

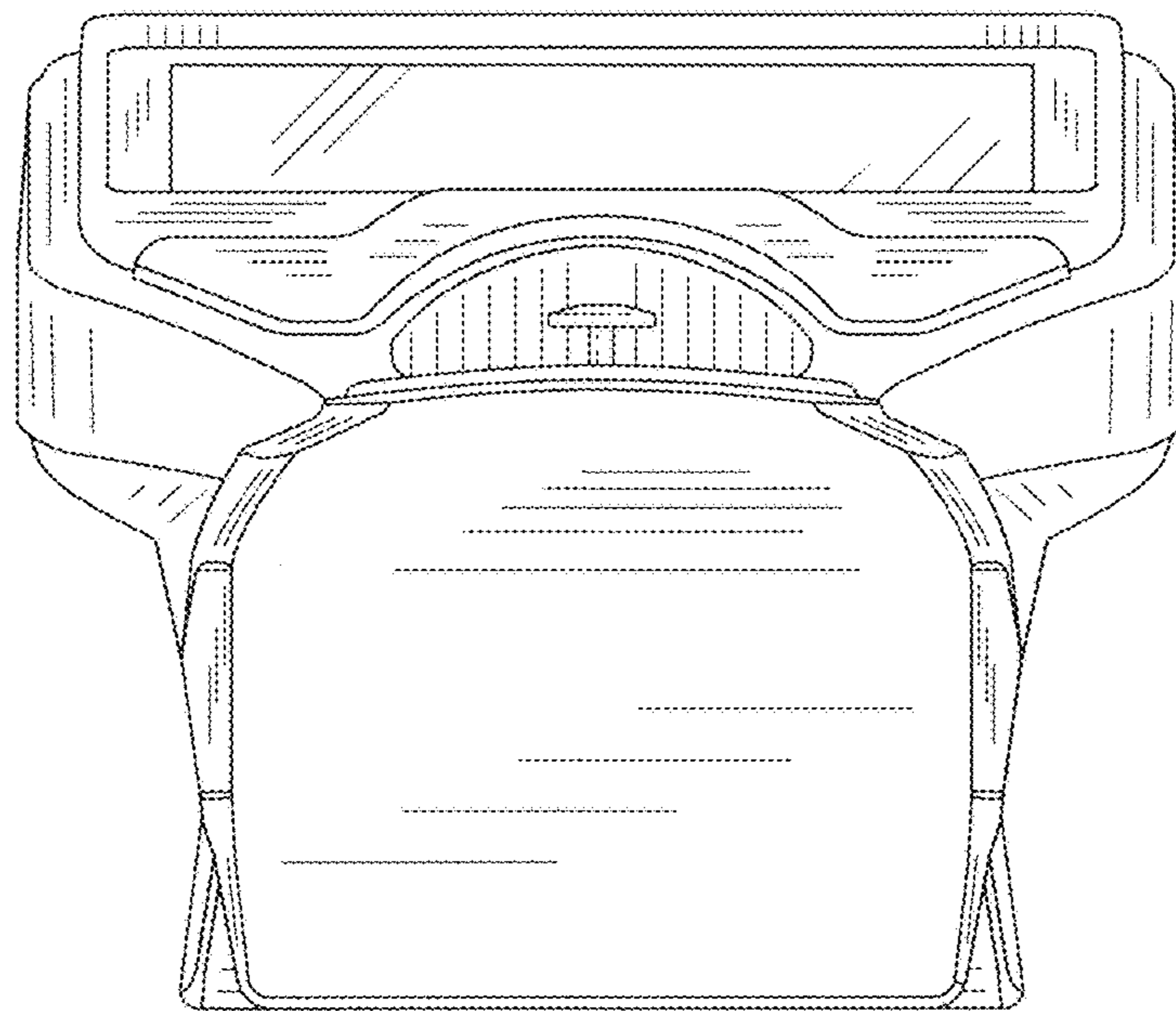

Fig. 6

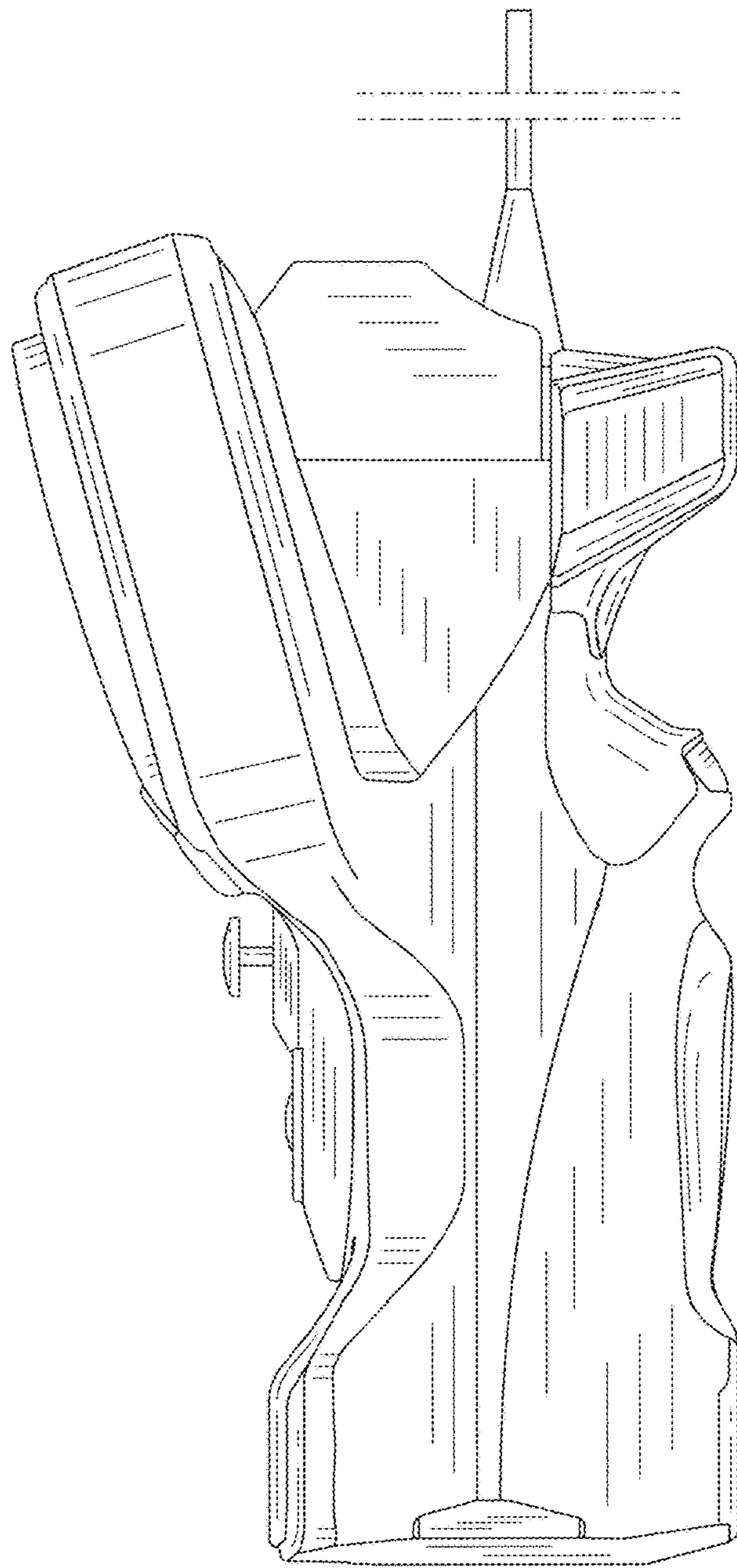

Fig. 7



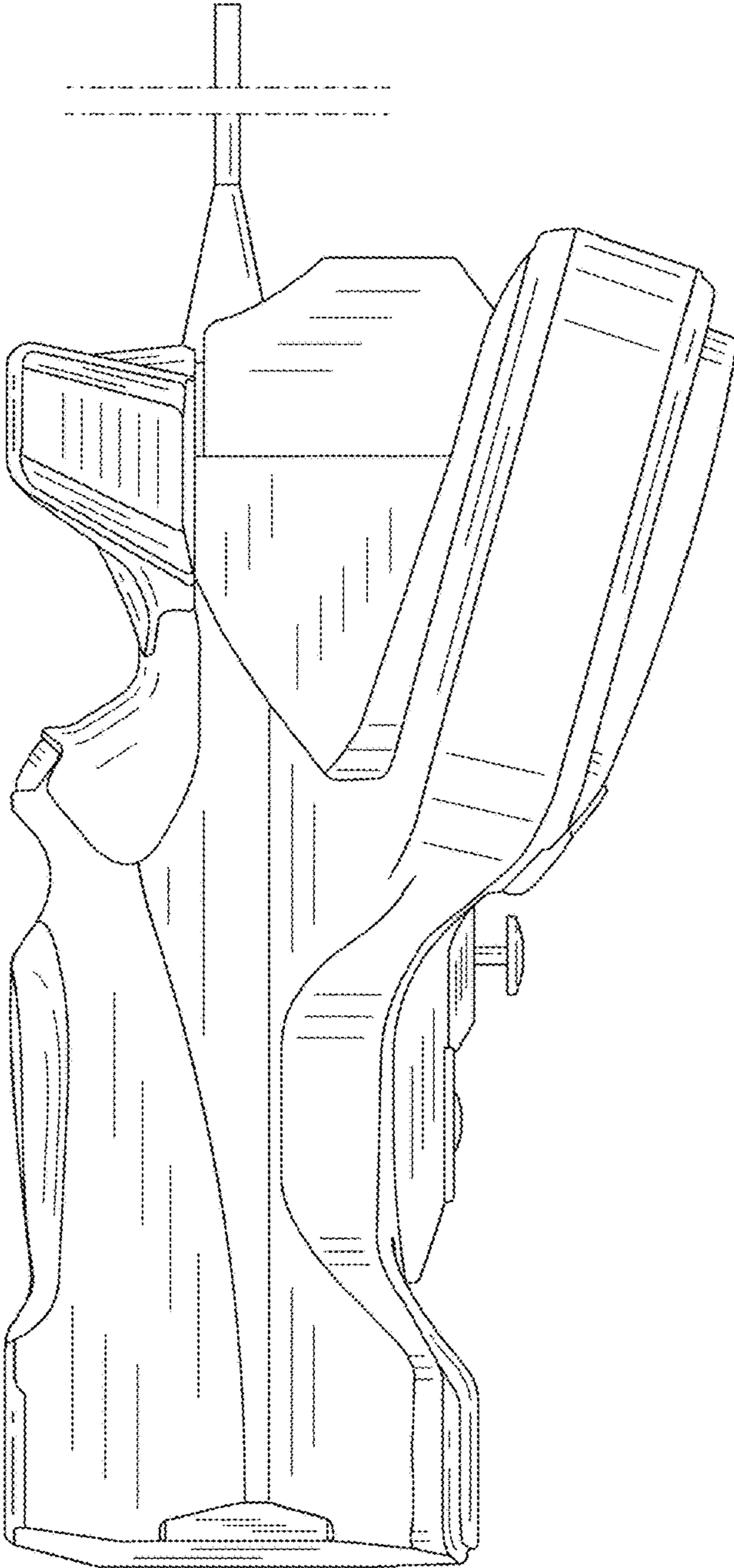

Fig. 8