



US00D865098S

(12) **United States Design Patent** (10) **Patent No.:** **US D865,098 S**
Sunday (45) **Date of Patent:** **** Oct. 29, 2019**

(54) **HIP ROTATION TRAINING APPARATUS**

(71) Applicant: **Darrin Sunday**, Ambler, PA (US)

(72) Inventor: **Darrin Sunday**, Ambler, PA (US)

(**) Term: **15 Years**

(21) Appl. No.: **29/617,199**

(22) Filed: **Sep. 12, 2017**

5,135,446 A	8/1992	Cooley	482/51
5,390,929 A	2/1995	Todaro	473/215
D364,911 S	12/1995	Todaro	D21/791
5,501,382 A	3/1996	Webb	206/372
D380,797 S *	7/1997	Schwan	D21/699
5,643,097 A	7/1997	Bechler	473/277
5,879,240 A	3/1999	Stuart	473/215
5,921,898 A *	7/1999	McDonald	A61H 37/005
			441/108
D423,596 S *	4/2000	Morrison	D21/754
6,283,351 B1	9/2001	Brite	224/238
D476,052 S *	6/2003	Barth	D21/698

(Continued)

Related U.S. Application Data

(63) Continuation-in-part of application No. 14/620,267, filed on Feb. 12, 2015, now abandoned.

(51) **LOC (12) Cl.** **21-02**

(52) **U.S. Cl.**
USPC **D21/780**

(58) **Field of Classification Search**
USPC D21/302-305, 731, 771, 791, 780, 804,
D21/805; D2/625, 639, 705, 714, 715,
D2/853, 864
CPC A63B 69/3608; A63B 69/00; A63B
2208/0204; A63B 2069/0008; A63B
2071/0602
See application file for complete search history.

(56) **References Cited**

U.S. PATENT DOCUMENTS

2,930,618 A	3/1960	Glantz	473/474
3,178,851 A	4/1965	Gage	273/DIG. 19
3,224,774 A	12/1965	Klotz	473/576
3,227,336 A	1/1966	Dickey	224/192
3,782,727 A	1/1974	Chirnomas	473/576
4,120,434 A	10/1978	Hewes	224/249
D263,408 S	3/1982	McMeley	D21/731
D275,779 S	10/1984	McMeley	D21/731
4,544,089 A	1/1985	Tabler	224/192
4,621,753 A	11/1986	Ridings	224/234
4,688,800 A	8/1987	Lopez	473/215
4,928,793 A	5/1990	Westimayer	108/152

OTHER PUBLICATIONS

“Hip Strike”, posted Apr. 5, 2017 [online], [retrieved Aug. 16, 2019]. Retrieved from internet, <https://www.youtube.com/watch?v=VZpKR7pD-Ug>.*

(Continued)

Primary Examiner — Kevin K Rudzinski
Assistant Examiner — Mehri F Bajoul
(74) *Attorney, Agent, or Firm* — Hayes Soloway P.C.

(57) **CLAIM**

I claim the ornamental design for a hip rotation training apparatus, as shown and described.

DESCRIPTION

FIG. 1 is a perspective view of a hip rotation training apparatus showing my new design;
FIG. 2 is a bottom view thereof;
FIG. 3 is a top view thereof;
FIG. 4 is a front side view thereof;
FIG. 5 is a back side view thereof;
FIG. 6 is a first side view thereof; and,
FIG. 7 is a second side view thereof.
Portions of the drawings shown in broken lines form are not part of the claimed design.

1 Claim, 4 Drawing Sheets

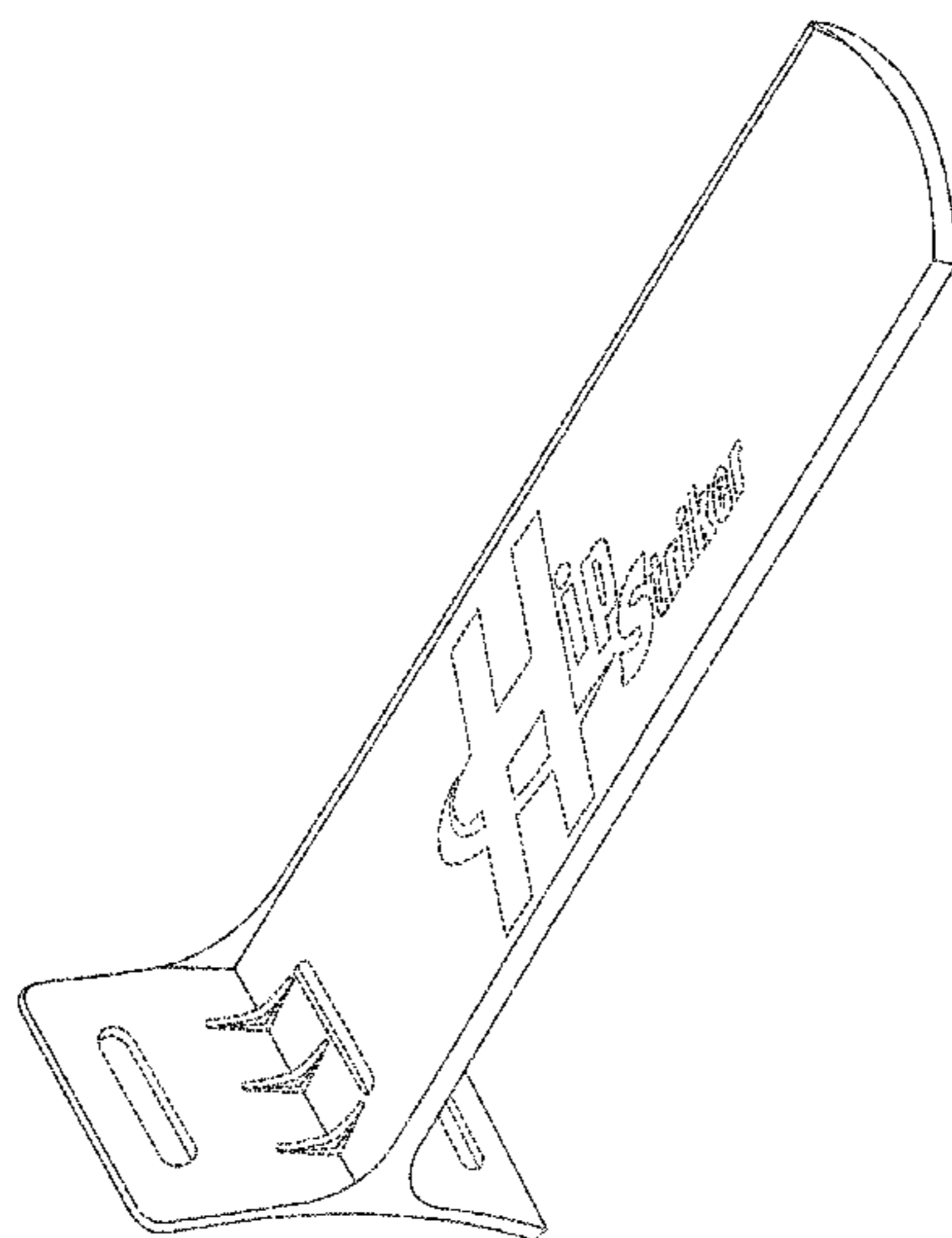

(56)

References Cited

U.S. PATENT DOCUMENTS

6,582,318	B1	6/2003	Halfacre	473/207
D489,867	S *	5/2004	Stahl	D2/639
6,896,631	B1	5/2005	Fairchild	473/422
6,932,724	B2	8/2005	Socci	473/422
D510,398	S *	10/2005	Heil	D21/771
D518,545	S *	4/2006	Renahan	D21/791
D538,373	S *	3/2007	Hedgepath	D21/780
D623,708	S *	9/2010	Masters	D21/719
D654,131	S *	2/2012	Crabtree	D21/791
D673,346	S *	1/2013	Kosh	D2/639
D692,641	S *	11/2013	Lai	D2/853
8,740,730	B1	6/2014	Przyborowski	473/438
8,986,139	B1	3/2015	Gideon	473/422
D794,148	S *	8/2017	Barlow-Gamble	D21/780
D809,903	S *	2/2018	Rothbaum	D8/356
D827,988	S *	9/2018	Jordan	D2/859
2012/0289382	A1 *	11/2012	Haddad	A63B 69/0024 482/93
2015/0151181	A1 *	6/2015	Jones	A63B 69/3608 473/210
2016/0236052	A1 *	8/2016	Sunday	A63B 69/00

OTHER PUBLICATIONS

“Hip striker rotational training aid”, posted date not available [online], [retrieved Aug. 16, 2019]. Retrieved from internet, https://www.hittingworld.com/ProductDetails.asp?ProductCode=HIP-100&Click=23323&utm_source=googlebase&utm_medium=shoppingengine&gclid=EAlaIQobChMI8qrf15GI5AIVhZ6zCh1EVQW1EAQYAiABEgK5GvD_BwE.*

“Hip striker rotational training aid”, posted date not available [online], [retrieved Aug. 16, 2019]. Retrieved from internet, https://www.amazon.com/s?k=The+Hip+Striker+Rotational+Training+Aid&ref=nb_sb_noss.*

U.S. Appl. No. 14/620,267, filed Feb. 12, 2015.

Office Action issued in U.S. Appl. No. 14/620,267, dated Jan. 4, 2016 (13 pgs).

Office Action issued in U.S. Appl. No. 14/620,267, dated Jan. 13, 2017 (25 pgs).

Office Action issued in U.S. Appl. No. 14/620,267, dated May 16, 2016 (21 pgs).

Office Action issued in U.S. Appl. No. 14/620,267, dated Jun. 12, 2017 (35 pgs).

* cited by examiner

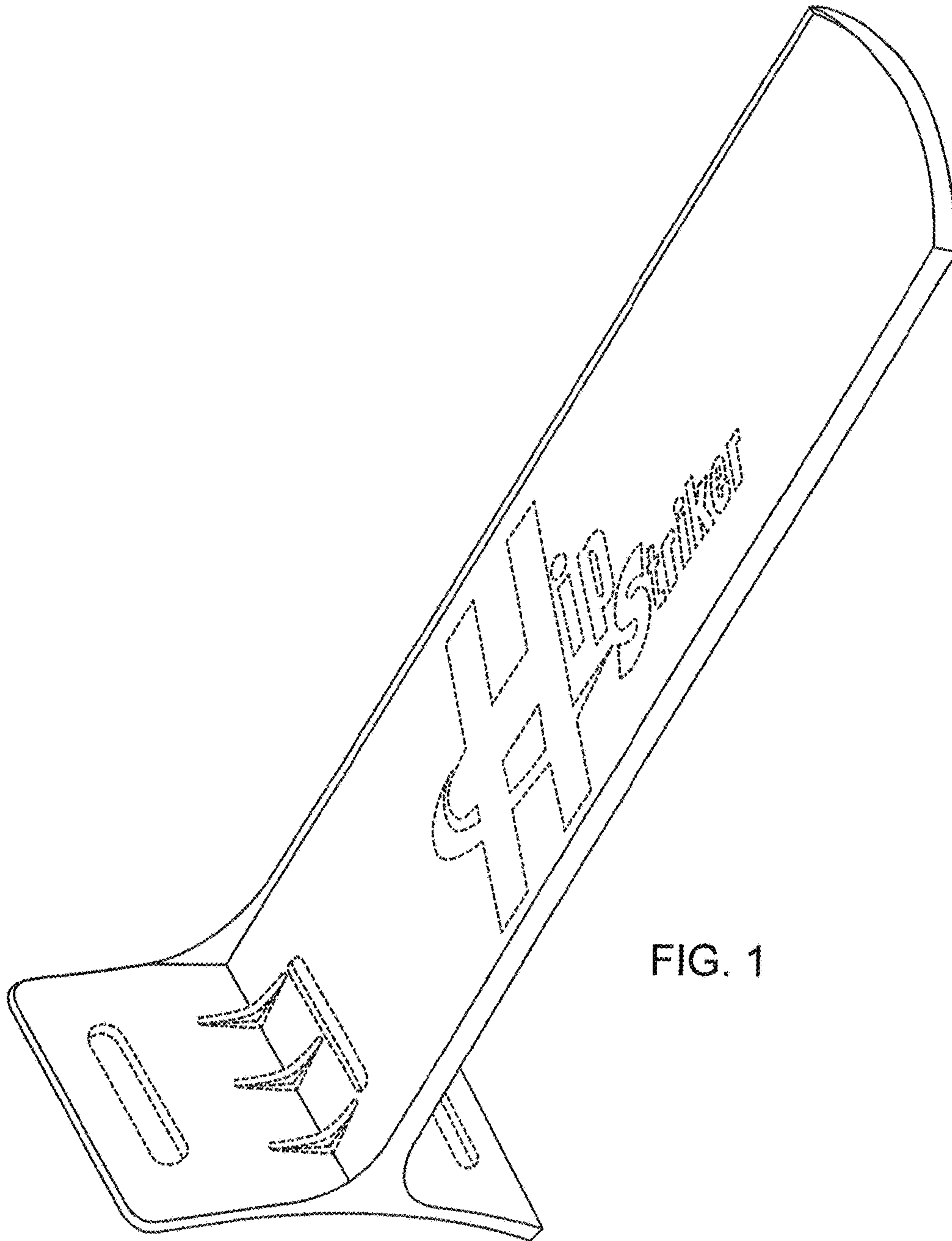

FIG. 1

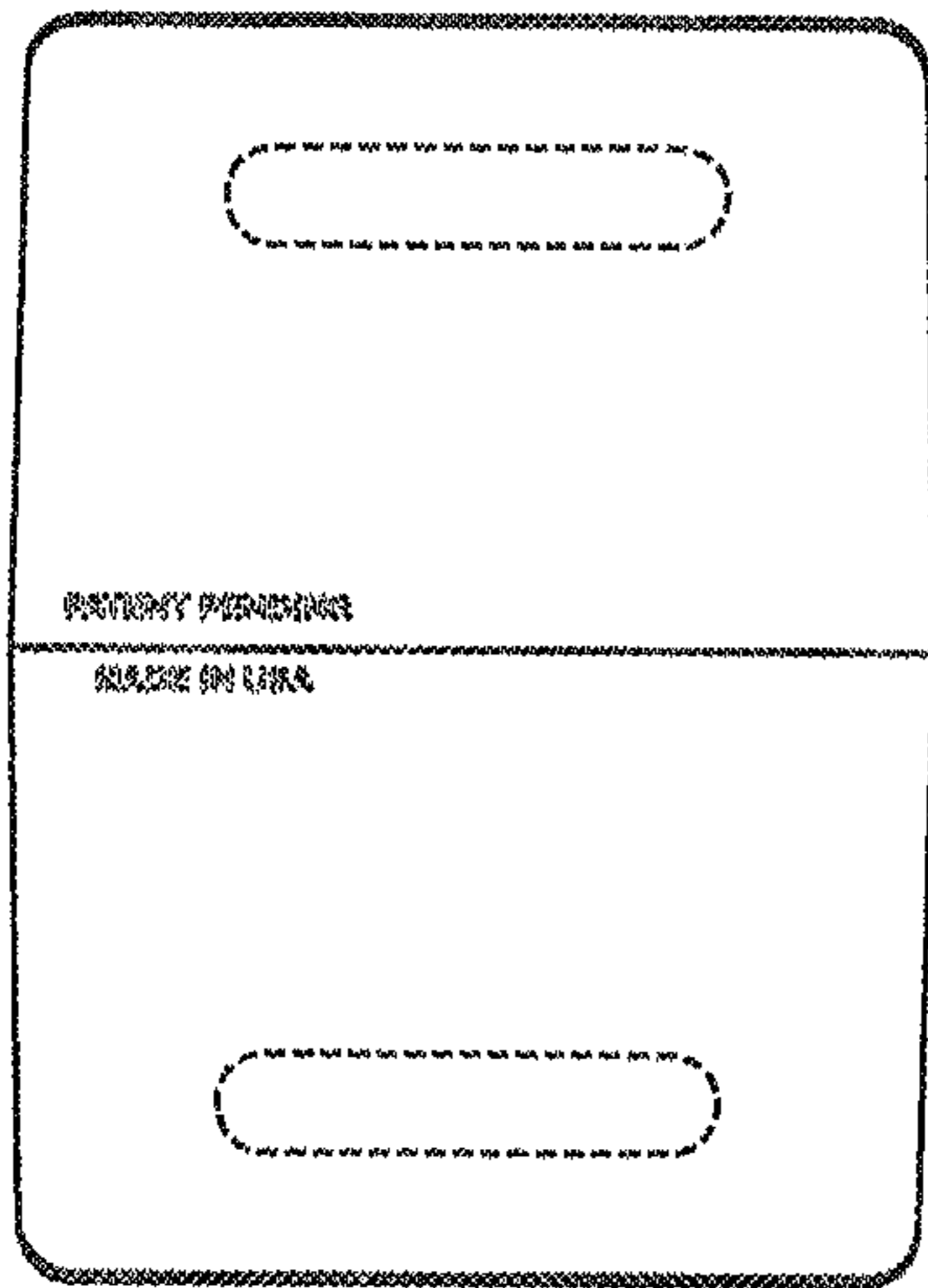

FIG. 2

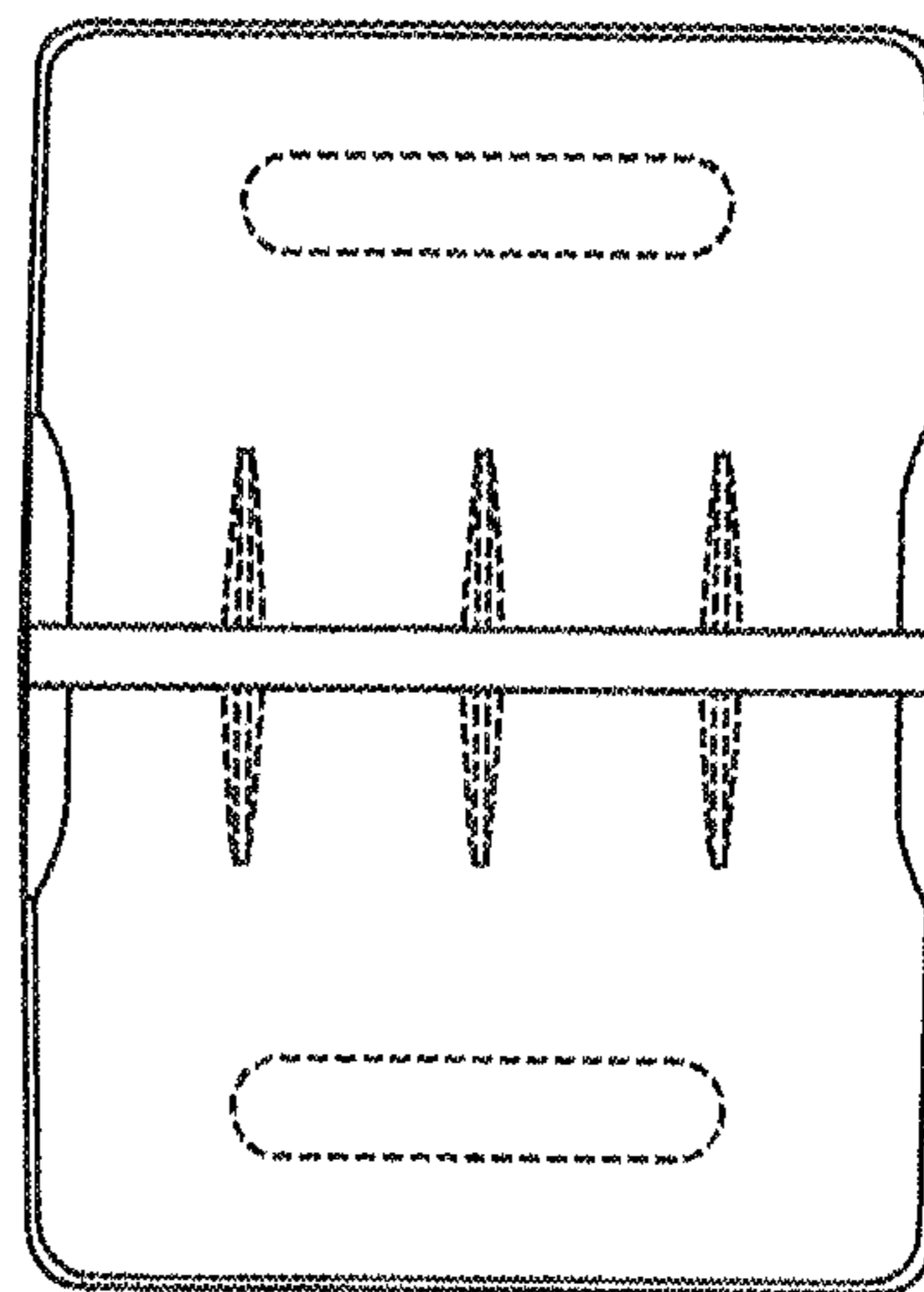

FIG. 3

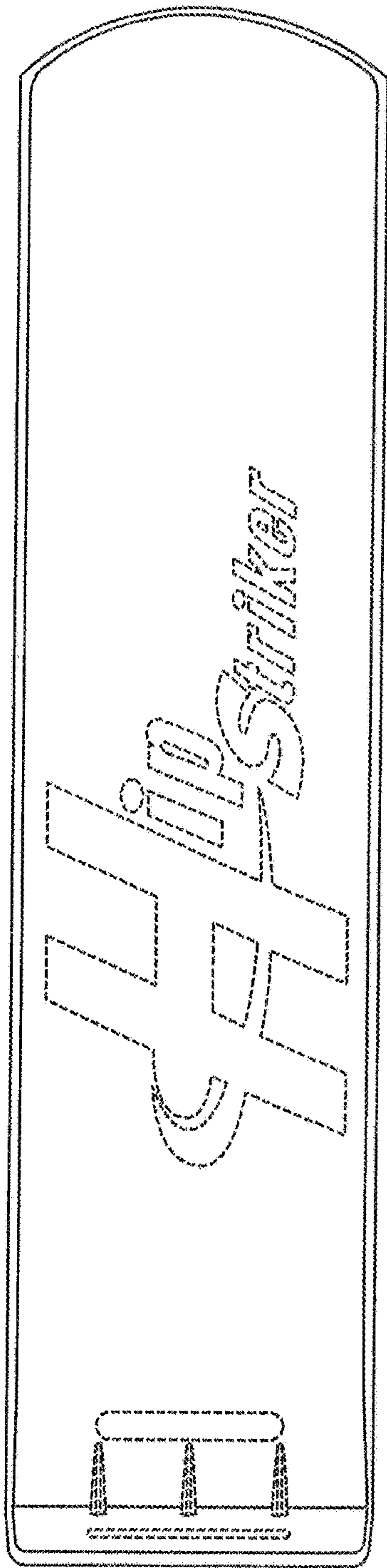

FIG. 4

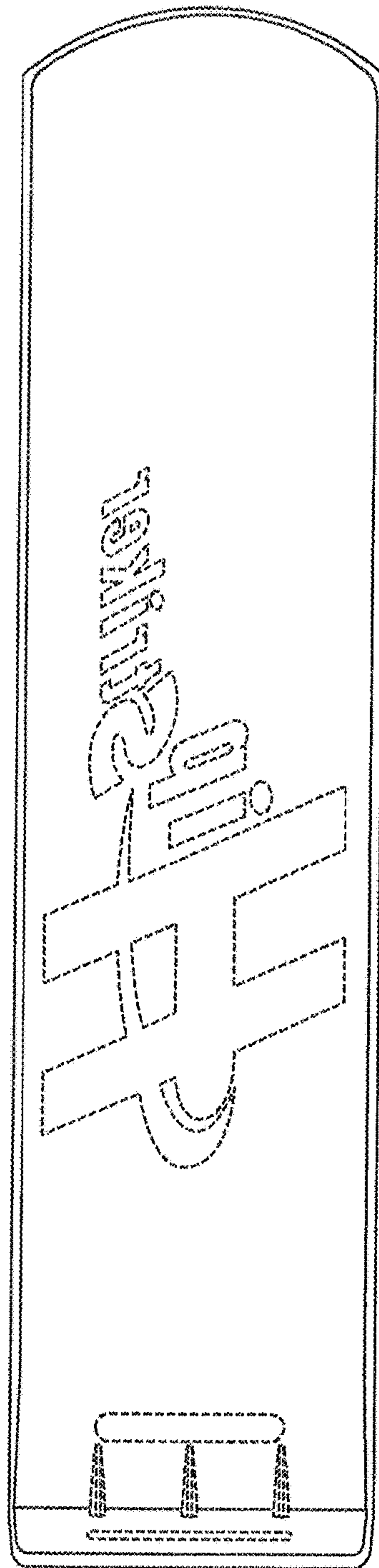

FIG. 5

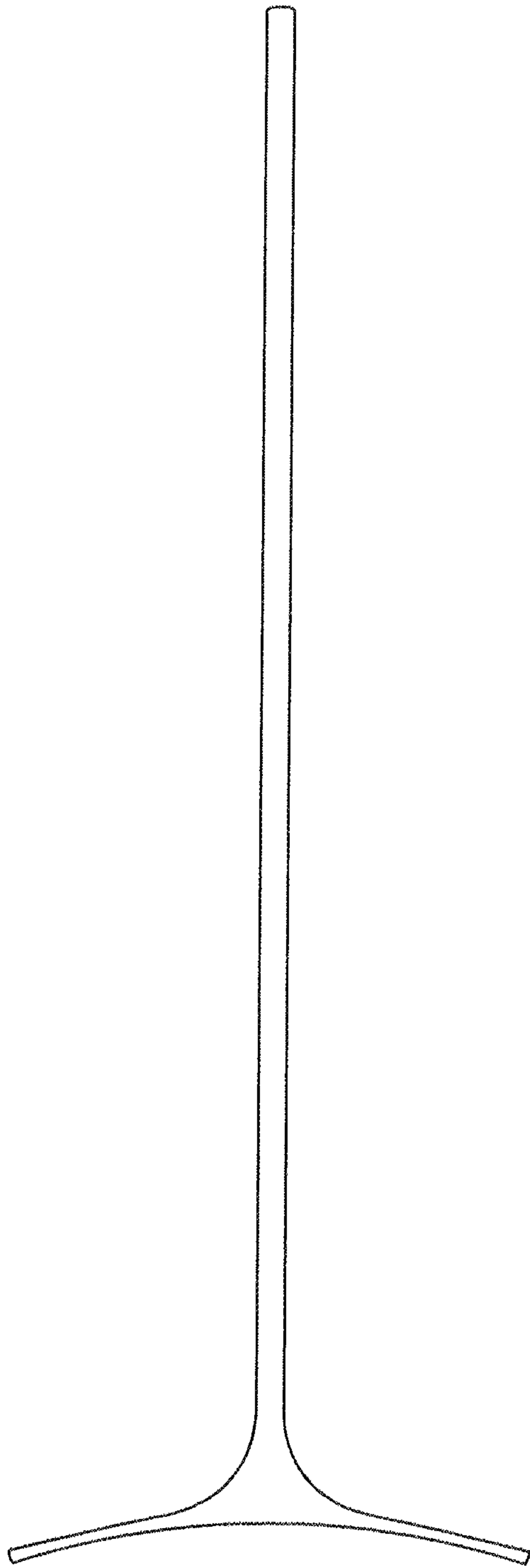

FIG. 6

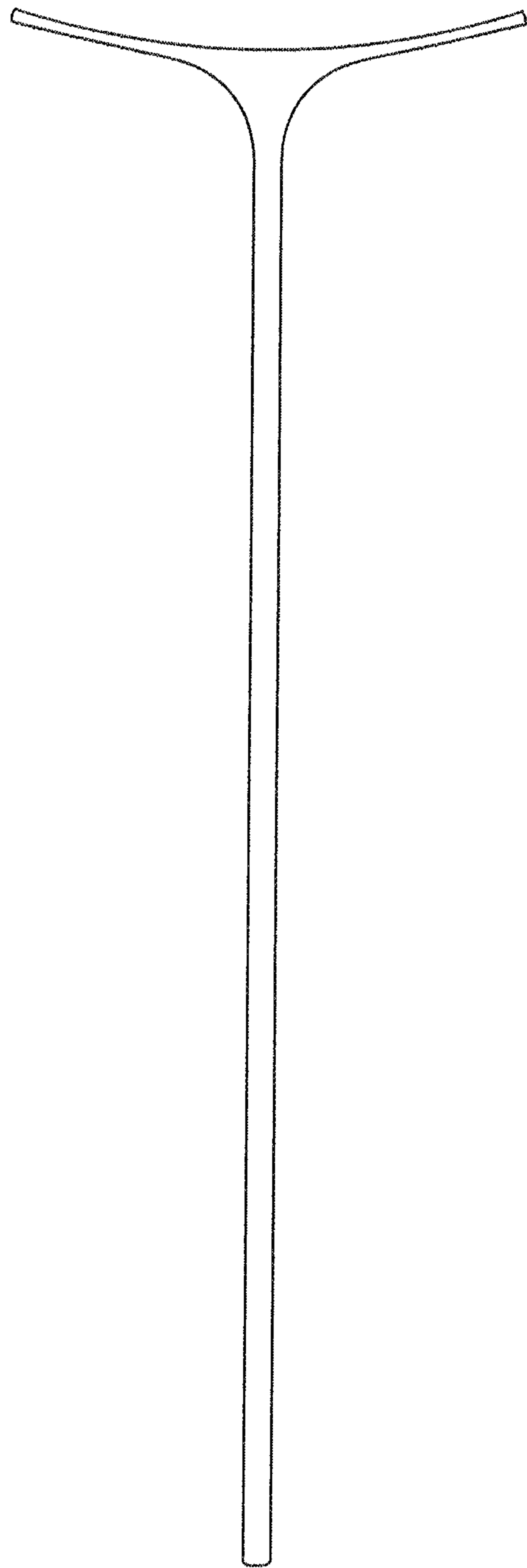

FIG. 7