

US00D865082S

(12) **United States Design Patent**
Zhao

(10) **Patent No.:** **US D865,082 S**

(45) **Date of Patent:** **** Oct. 29, 2019**

(54) **TOY BOY**

(71) Applicant: **QuanZhou ZhuTing Trading Co., Ltd.**, Quanzhou, Fujian (CN)

(72) Inventor: **FuXiao Zhao**, Fujian (CN)

(73) Assignee: **QuanZhou ZhuTing Trading Co., Ltd.**, Quanzhou (CN)

(**) Term: **15 Years**

(21) Appl. No.: **29/697,723**

(22) Filed: **Jul. 10, 2019**

(51) **LOC (12) Cl.** **21-01**

(52) **U.S. Cl.**
USPC **D21/621**

(58) **Field of Classification Search**
USPC D21/621, 622, 630, 658, 659, 660, 661
CPC A63H 3/00-31
See application file for complete search history.

(56) **References Cited**

U.S. PATENT DOCUMENTS

D323,197 S 1/1992 Mariol
D440,263 S * 4/2001 Norman D21/621
D509,267 S 9/2005 Robinson

D614,252 S * 4/2010 Pilgaard D21/621
D647,979 S * 11/2011 Fromuth D21/621
D650,869 S * 12/2011 Eisenstein D21/621
D657,007 S * 4/2012 O'Leary D21/621
D842,396 S * 3/2019 Vezina D21/621
D846,433 S * 4/2019 Charria D11/160
D847,915 S * 5/2019 Dawson D21/621

* cited by examiner

Primary Examiner — Zenia I Bennett

(57) **CLAIM**

The ornamental design for a toy boy, as shown and described.

DESCRIPTION

FIG. 1 is a front and top perspective view of a toy boy showing my new design;
FIG. 2 is a back and bottom perspective view thereof;
FIG. 3 is a front view thereof;
FIG. 4 is a back view thereof;
FIG. 5 is a left side view thereof;
FIG. 6 is a right side view thereof;
FIG. 7 is a top view thereof;
FIG. 8 is a bottom view thereof; and,
FIG. 9 is a perspective view of the toy boy when it is in use.
The broken lines in the figures illustrate portions of the toy boy that form no part of the claimed design. The broken lines in the figures indicate the environmental structure that form no part of the claimed design.

1 Claim, 9 Drawing Sheets





FIG. 1

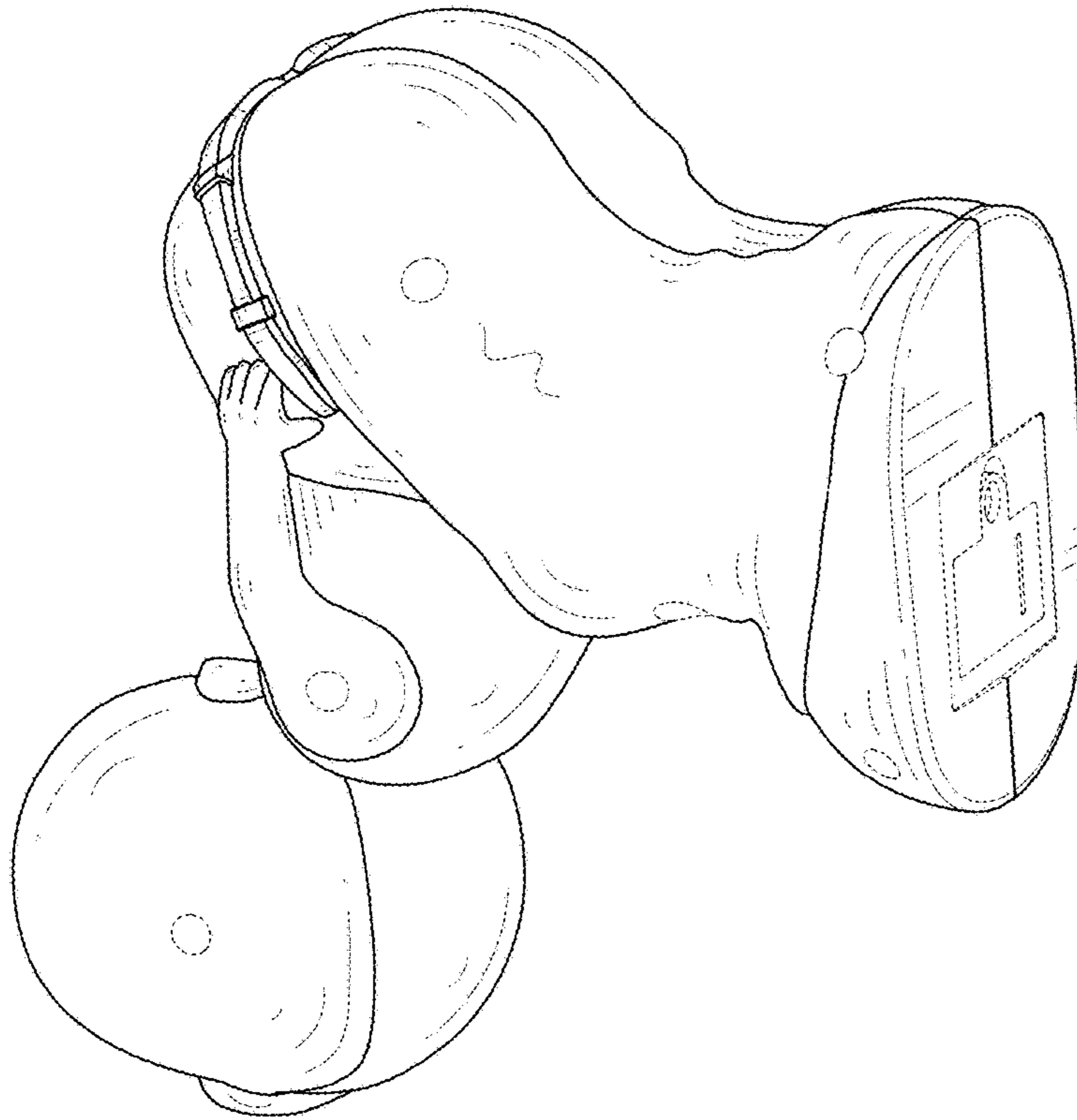

FIG. 2

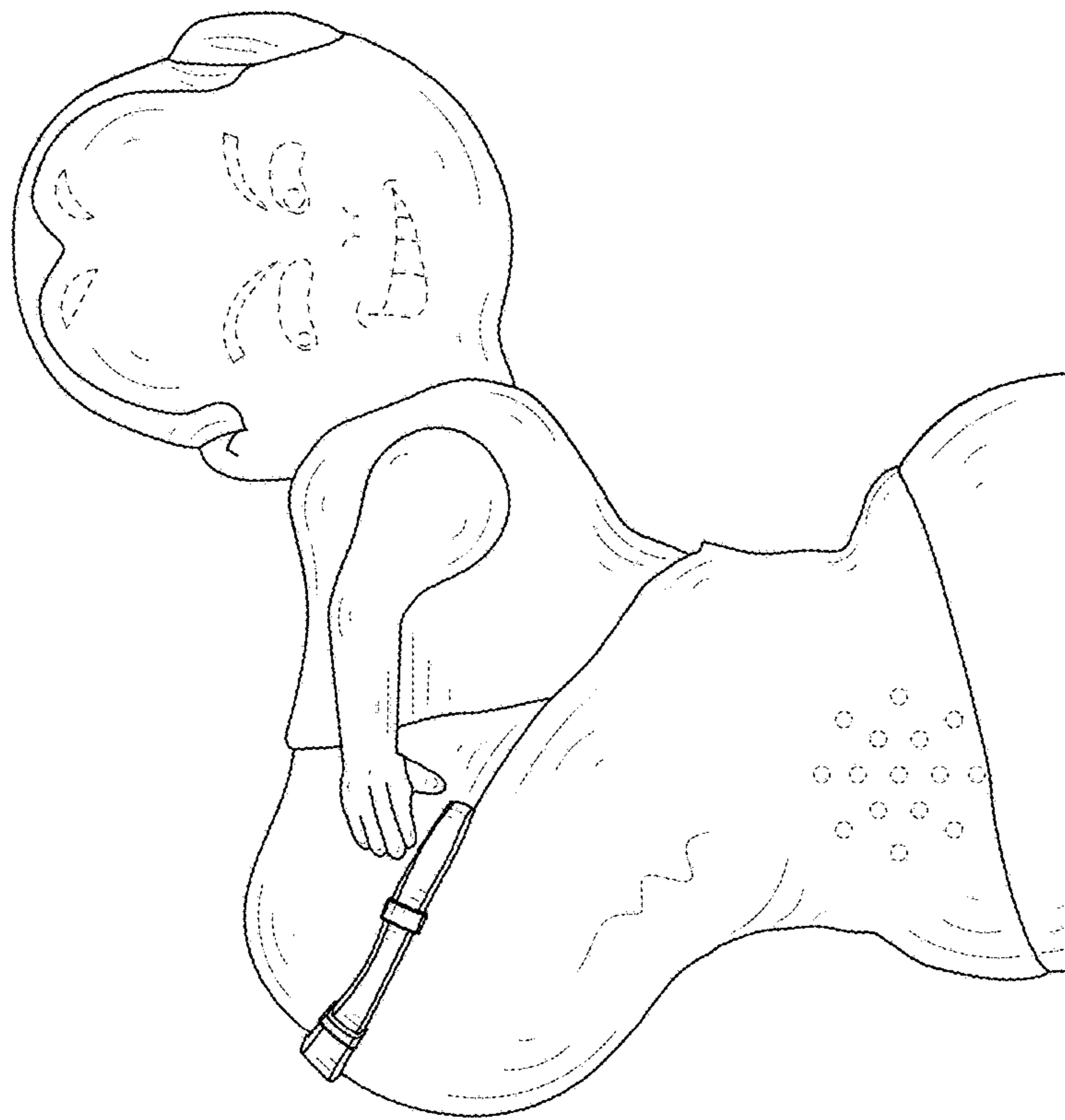

FIG. 3

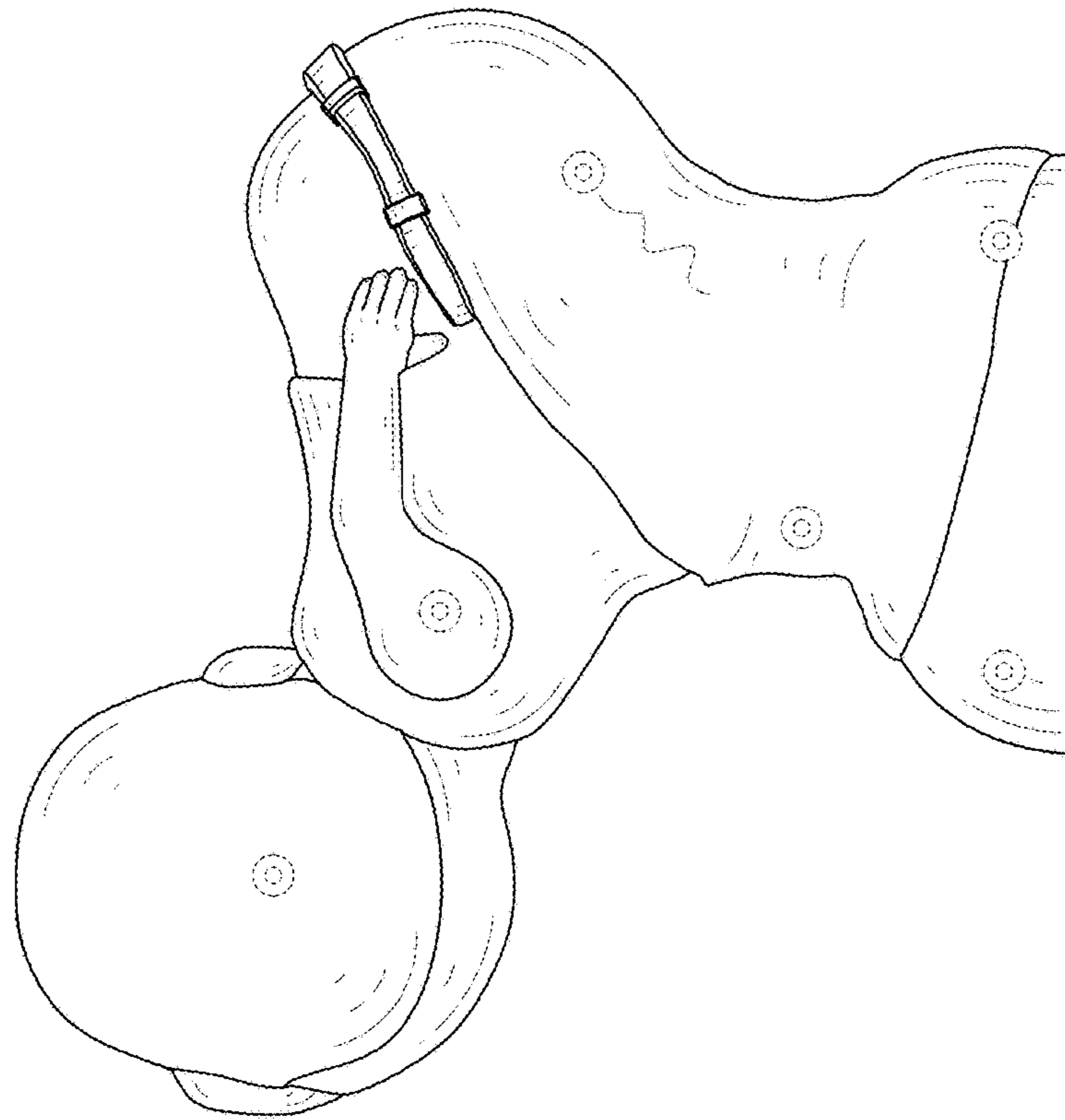

FIG. 4

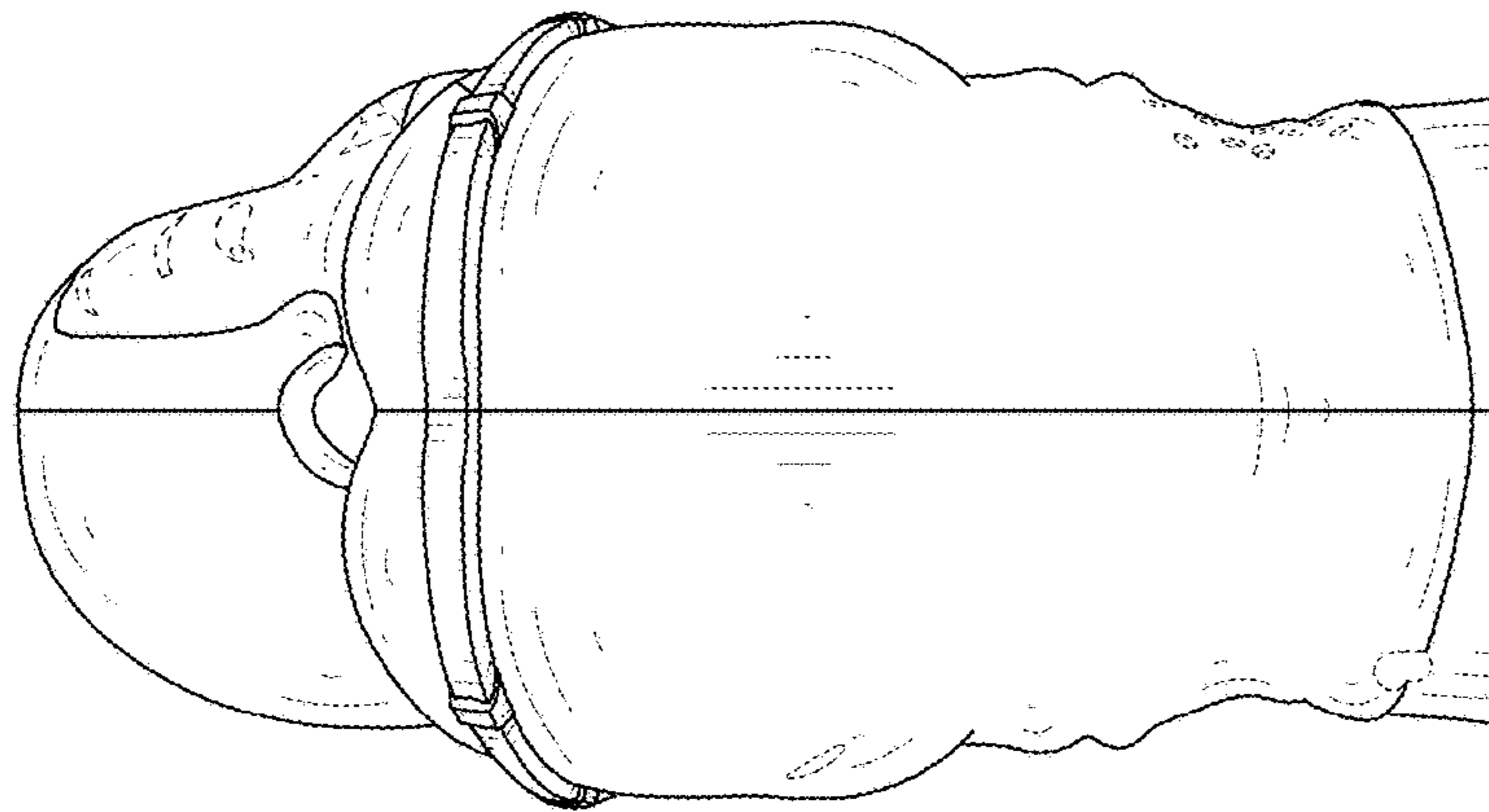

FIG. 5

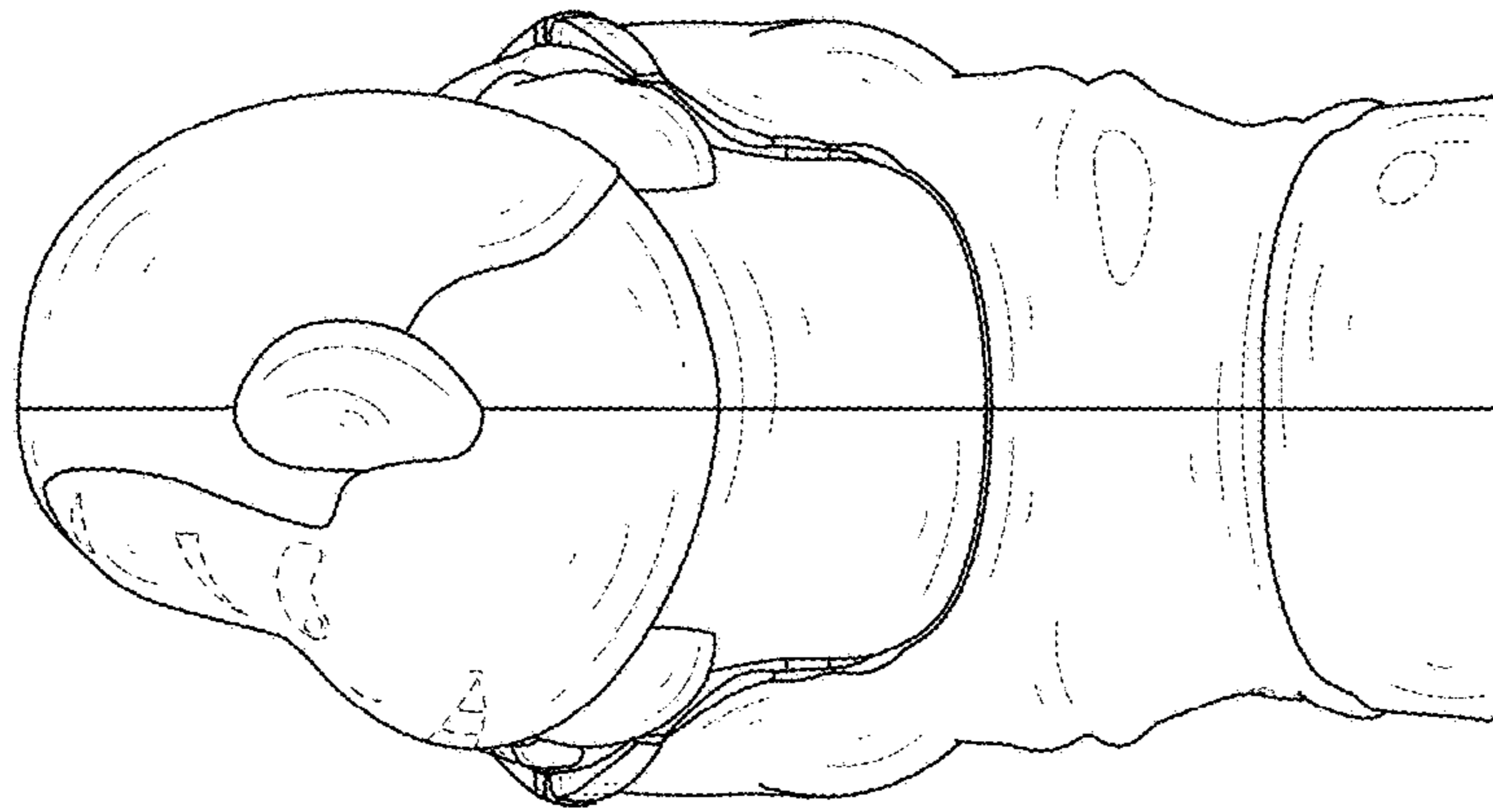

FIG. 6

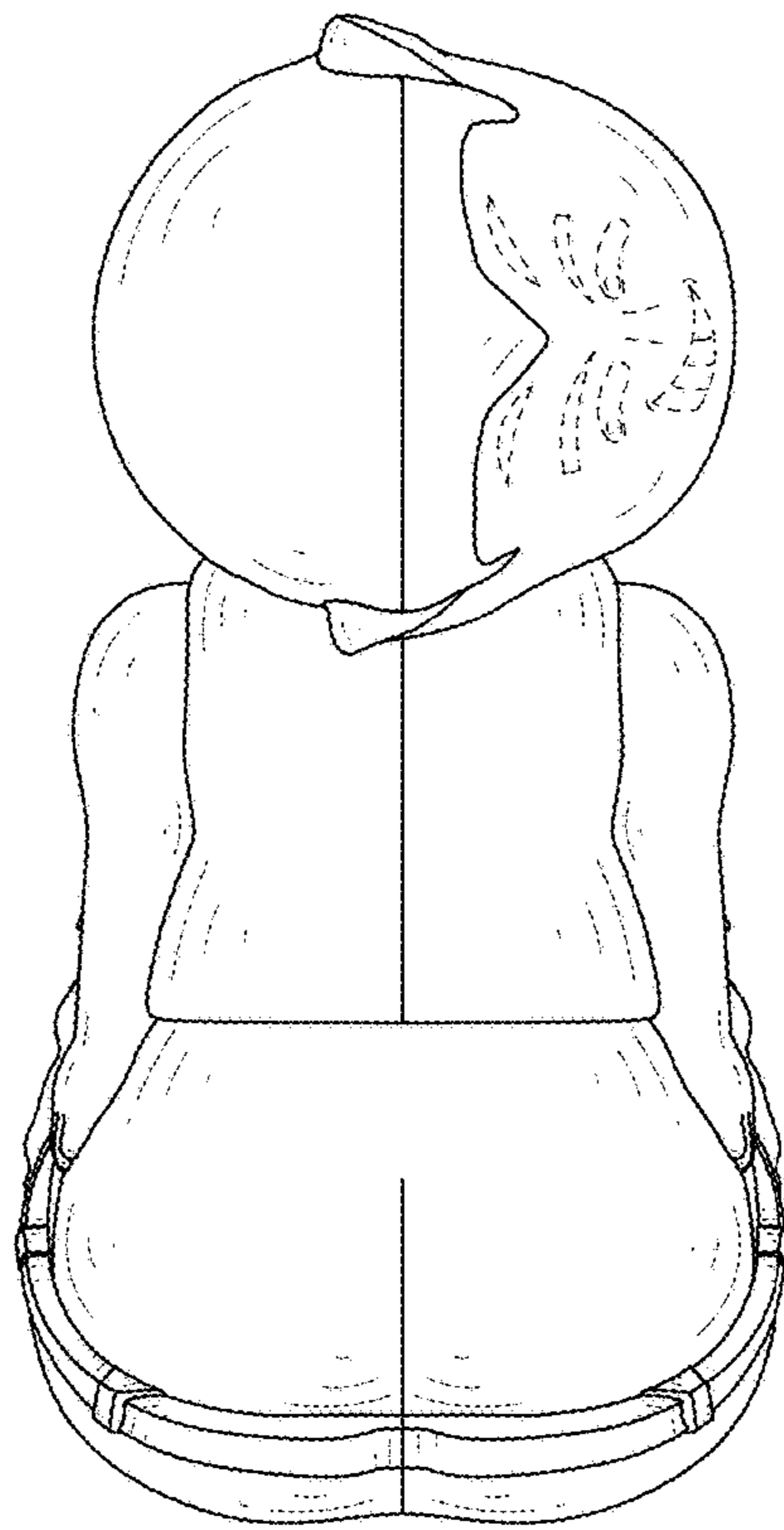

FIG. 7

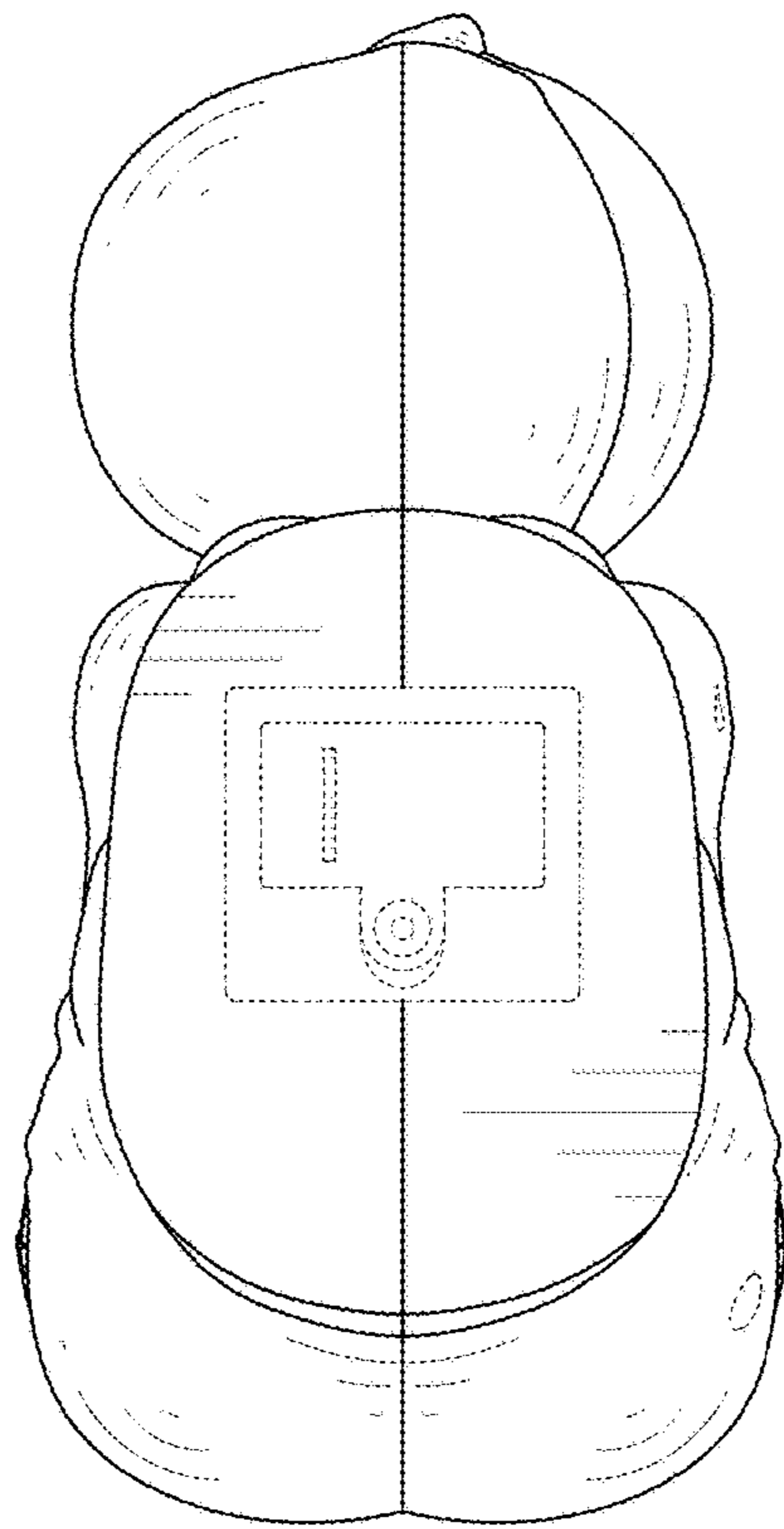

FIG. 8



FIG. 9