



US00D865074S

(12) **United States Design Patent**
Holman

(10) **Patent No.:** **US D865,074 S**
(45) **Date of Patent:** **** Oct. 29, 2019**

(54) **SIMPLE MACHINES PLAY CONSTRUCTION KIT**

(71) Applicant: **Heroes Will Rise, Inc.**, Hope, RI (US)

(72) Inventor: **Cas Holman**, Hope, RI (US)

(**) Term: **15 Years**

(21) Appl. No.: **29/663,063**

(22) Filed: **Sep. 11, 2018**

(51) **LOC (12) Cl.** **21-01**

(52) **U.S. Cl.**
USPC **D21/484**; D21/492

(58) **Field of Classification Search**
USPC D21/333, 373, 386, 389, 404, 468, 470,
D21/471, 475, 484-505

(Continued)

(56) **References Cited**

U.S. PATENT DOCUMENTS

1,763,302 A * 6/1930 Gilbert A63H 33/042
446/90
1,792,976 A * 2/1931 Gilbert A63H 33/042
446/112

(Continued)

Primary Examiner — Cynthia M. Chin

(74) *Attorney, Agent, or Firm* — Joseph D. Hodler

(57) **CLAIM**

The ornamental design for a simple machines play construction kit, as shown and described.

DESCRIPTION

FIG. 1 is a top, front, right isometric view of a first part of the simple machines play construction kit;

FIG. 2 is a front view of the first part, the rear view being a mirror image thereof;

FIG. 3 is a right view of the first part, the left view being a mirror image thereof;

FIG. 4 is a top, front, right isometric view of a second part of the simple machines play construction kit;

FIG. 5 is a front view of the second part, the rear view being a mirror image thereof;

FIG. 6 is a right view of the second part;

FIG. 7 is a top, front, right isometric view of a third part of the simple machines play construction kit;

FIG. 8 is a front view of the third part, the rear view being a mirror image thereof;

FIG. 9 is a right view of the third part, the left view being a mirror image thereof;

FIG. 10 is a top, front, right isometric view of a fourth part of the simple machines play construction kit;

FIG. 11 is a front view of the fourth part, the rear view being a mirror image thereof;

FIG. 12 is a right view of the fourth part;

FIG. 13 is an enlarged top, front, right isometric view of a fifth part of the simple machines play construction kit;

FIG. 14 is an enlarged front view of the fifth part, the rear view being a mirror image thereof;

FIG. 15 is an enlarged right view of the fifth part, the left view being a mirror image thereof;

FIG. 16 is a top, front, left isometric view of a sixth part of the simple machines play construction kit;

FIG. 17 is a left view of the sixth part;

FIG. 18 is a front view of the sixth part, the rear view being a mirror image thereof;

FIG. 19 is a right view of the sixth part;

FIG. 20 is a bottom view of the sixth part, the top view being a mirror image thereof;

FIG. 21 is an enlarged top, front, left isometric view of a seventh part of the simple machines play construction kit;

FIG. 22 is an enlarged left view of the seventh part;

FIG. 23 is an enlarged front view of the seventh part, the rear view being a mirror image thereof;

FIG. 24 is an enlarged right view of the seventh part;

FIG. 25 is an enlarged bottom view of the seventh part, the top view being a mirror image thereof;

FIG. 26 is a top, front, right isometric view of an eighth part of the simple machines play construction kit;

FIG. 27 is a front view of the eighth part, the rear view being a mirror image thereof;

(Continued)

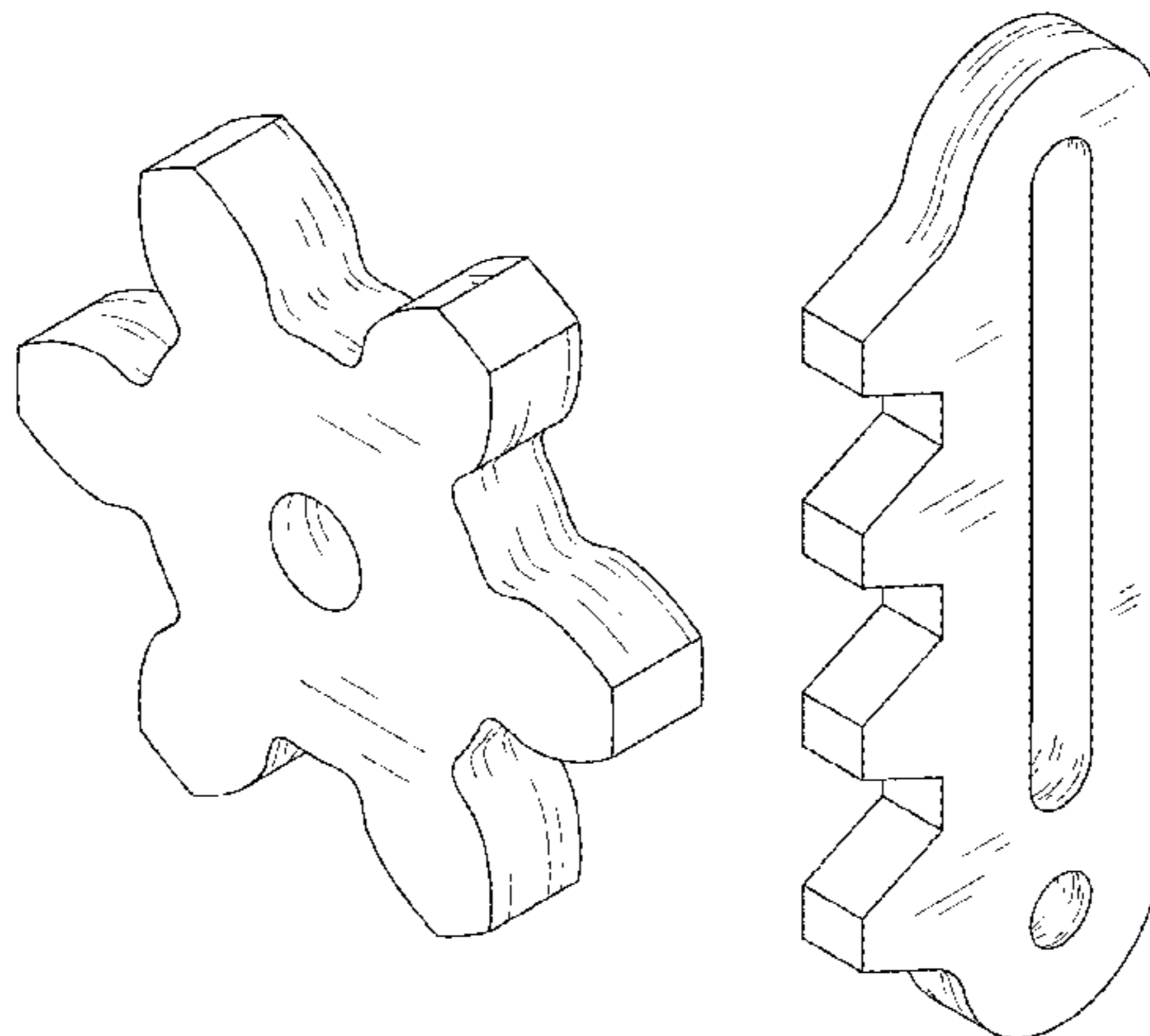

FIG. 28 is a right view of the eighth part, the left view being a mirror image thereof;
 FIG. 29 is an enlarged top, front, right isometric view of a ninth part of the simple machines play construction kit;
 FIG. 30 is an enlarged front view of the ninth part, the rear view being a mirror image thereof;
 FIG. 31 is an enlarged right view of the ninth part, the left view being a mirror image thereof;
 FIG. 32 is a top, front, right isometric view of a tenth part of the simple machines play construction kit;
 FIG. 33 is a left view of the tenth part;
 FIG. 34 is a right view of the tenth part;
 FIG. 35 is a top view of the tenth part, the bottom view being a mirror image thereof;
 FIG. 36 is a front view of the tenth part;
 FIG. 37 is a top, front, right isometric view of an eleventh part of the simple machines play construction kit;
 FIG. 38 is a left view of the eleventh part;
 FIG. 39 is a right view of the eleventh part;
 FIG. 40 is a top view of the eleventh part;
 FIG. 41 is a front view of the eleventh part;
 FIG. 42 is a bottom view of the eleventh part;
 FIG. 43 is a top, front, right isometric view of a twelfth part of the simple machines play construction kit;
 FIG. 44 is a left view of the twelfth part;
 FIG. 45 is a front view of the twelfth part; the rear view being a mirror image thereof;
 FIG. 46 is a right view of the twelfth part;
 FIG. 47 is a bottom view of the twelfth part; the top view being a mirror image thereof; and,
 FIG. 48 is a top, front, right view of the second part of the simple machines play construction kit shown in an exemplary assembly. The broken lines represent an exemplary arrangement in which the article resides and forms no part of the claim.

The twelve parts from the simple machines play construction kit are shown separately, and enlarged where appropriate, for ease and clarity of illustration.

1 Claim, 24 Drawing Sheets

(58) **Field of Classification Search**

CPC A63H 33/04; A63H 33/06; A63H 33/062;
 A63H 33/08; A63H 33/086; A63H
 33/088; A63H 33/10; A63H 33/101;
 A63H 33/108; A63H 33/12; A63F 9/12;
 A63F 9/1224

See application file for complete search history.

(56)

References Cited

U.S. PATENT DOCUMENTS

1,996,722	A *	4/1935	Gilbert	A63H 33/12 446/116
D206,012	S *	10/1966	Kristiansen	D21/488
4,547,160	A *	10/1985	Labelle	G09B 1/40 273/292
4,589,853	A *	5/1986	Hidvegi	A63H 33/12 446/104
D330,052	S *	10/1992	Klitsner	D21/488
D364,199	S *	11/1995	Schmidt	D21/488
D366,073	S *	1/1996	Schmidt	D21/488
D452,121	S *	12/2001	Teichelman	D21/488
D685,861	S	7/2013	Holman	
D723,631	S *	3/2015	Kanbar	D21/488
D723,632	S *	3/2015	Kanbar	D21/488
9,550,130	B2 *	1/2017	Petty	A63H 33/042
D786,364	S *	5/2017	Richards	D21/484
D830,473	S	10/2018	Holman	

* cited by examiner

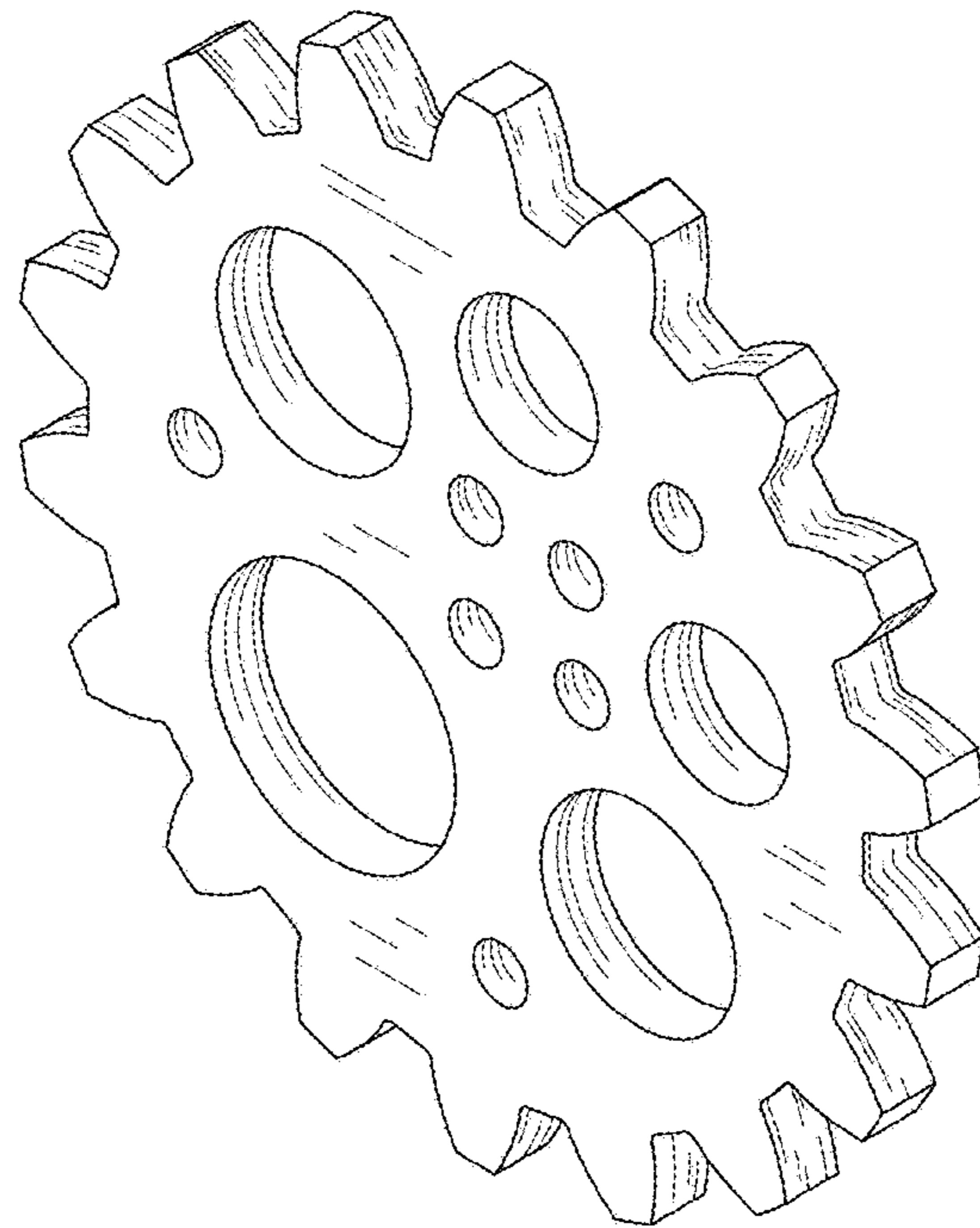

Fig. 1

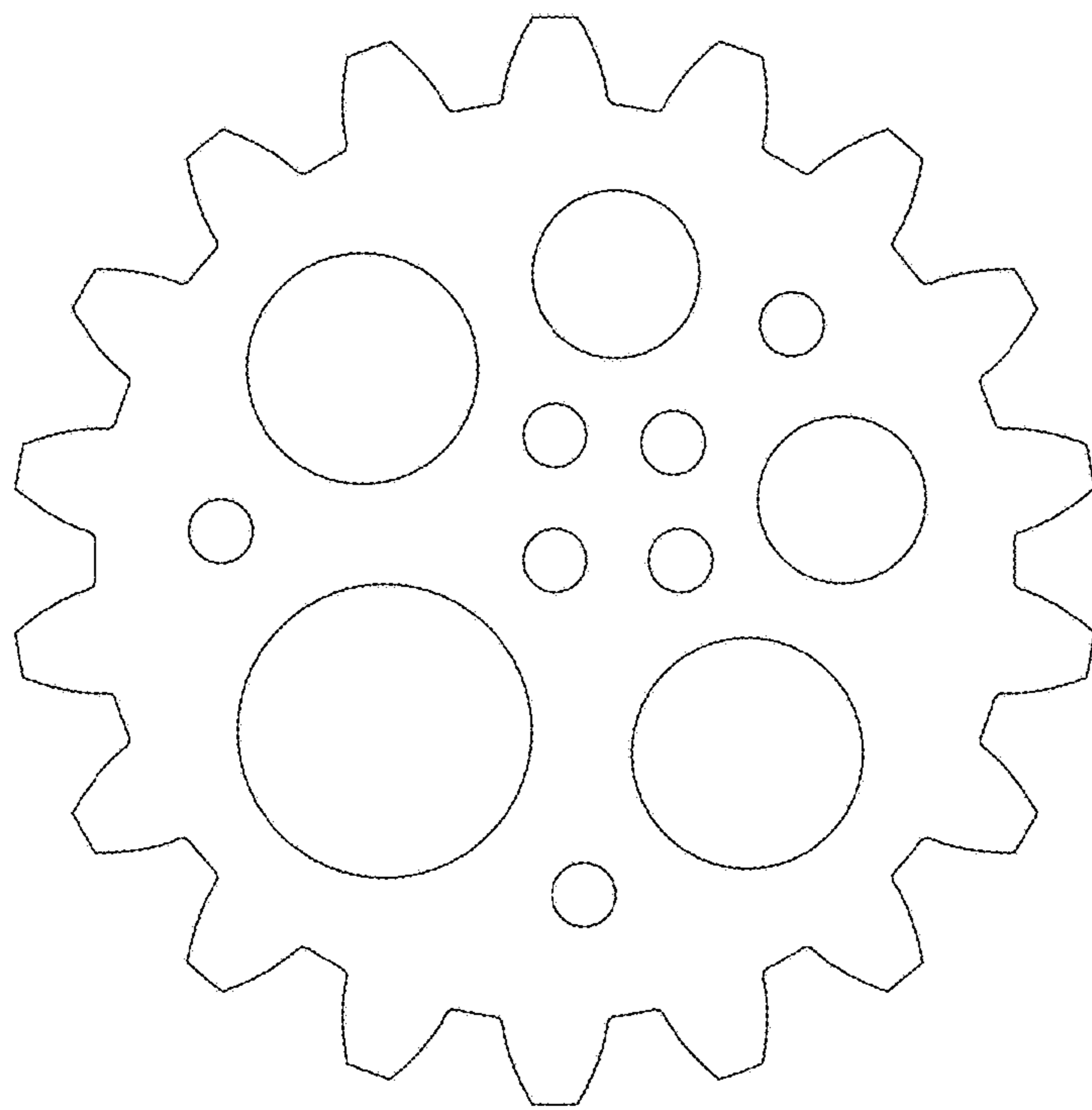

Fig. 2



Fig. 3

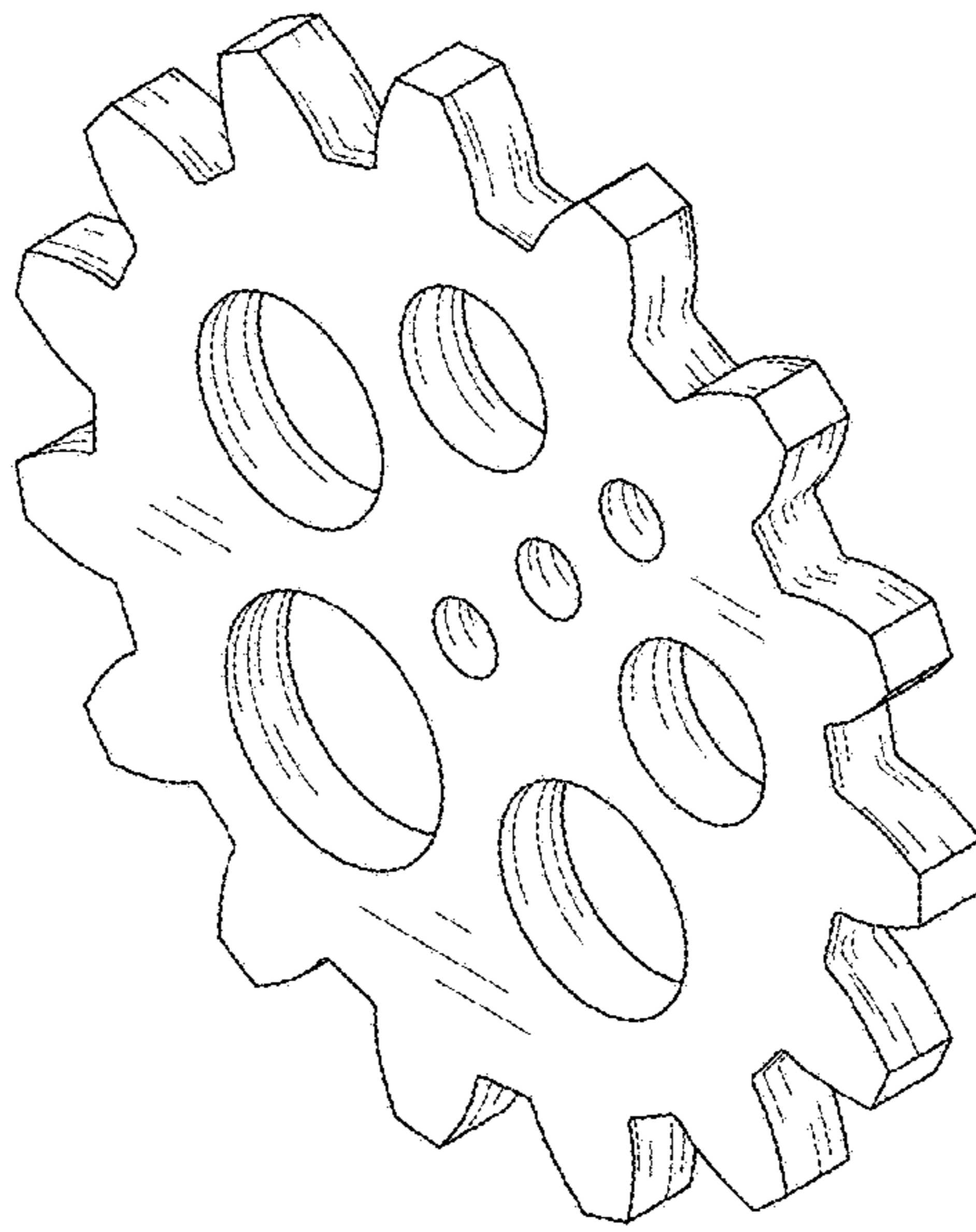

Fig. 4

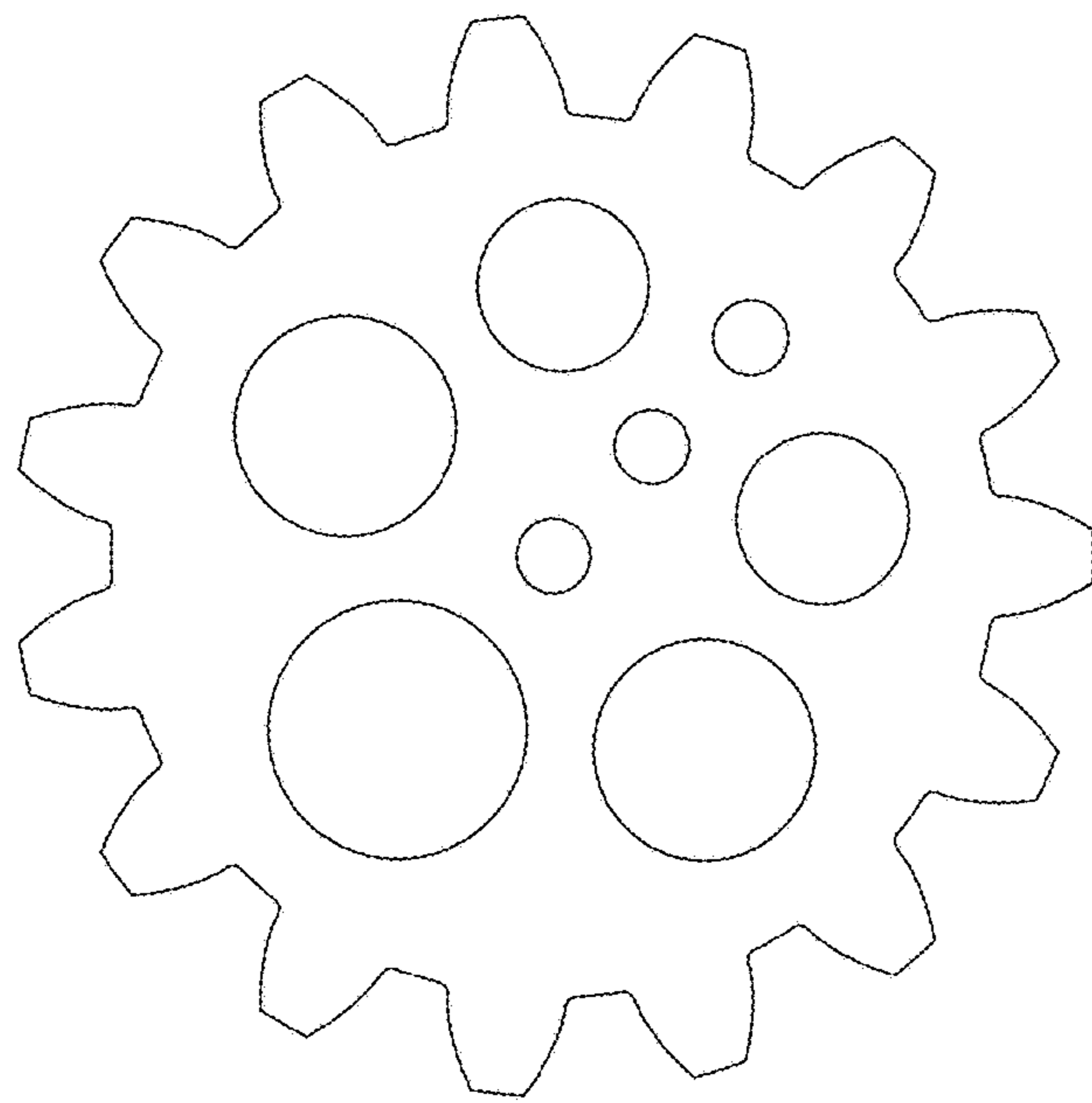

Fig. 5

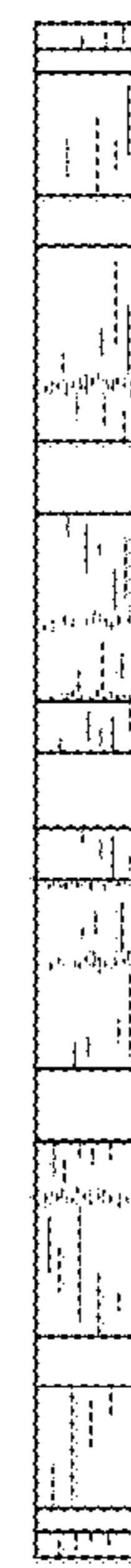

Fig. 6

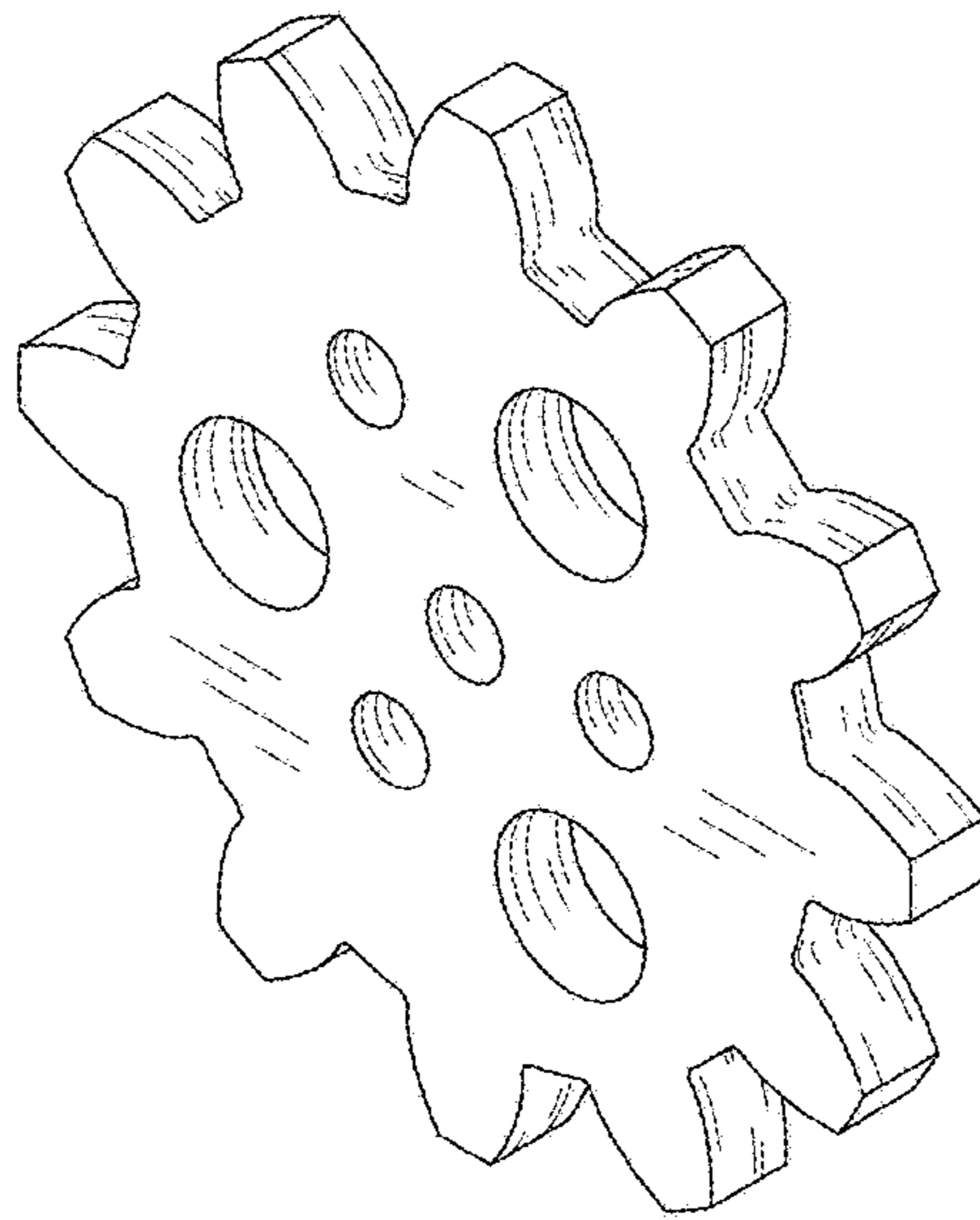

Fig. 7

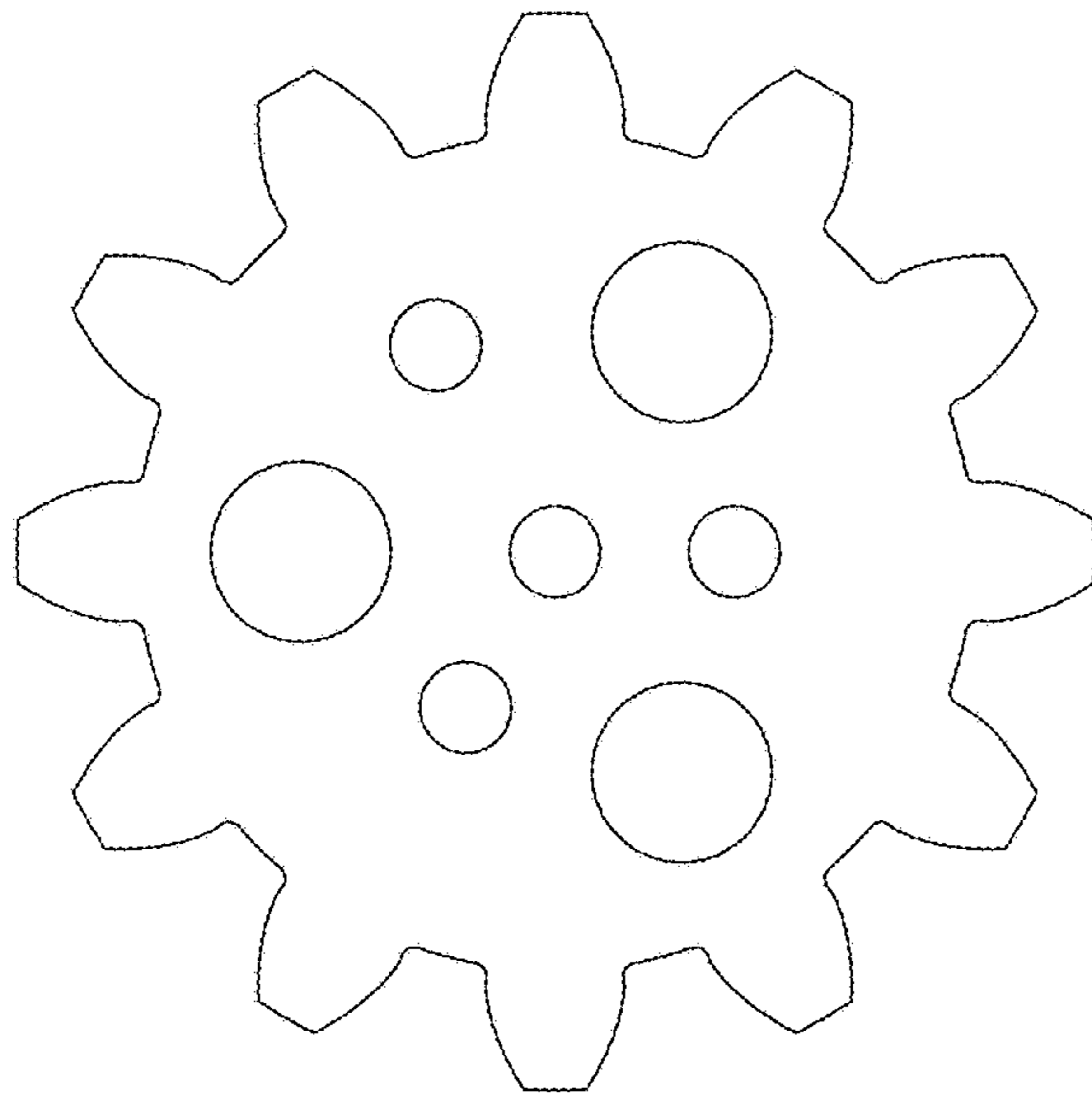

Fig. 8

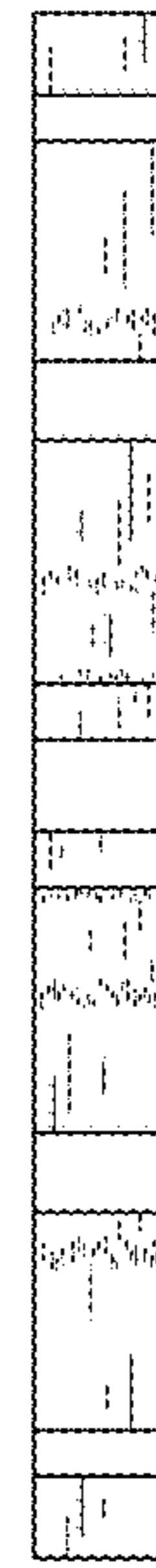

Fig. 9

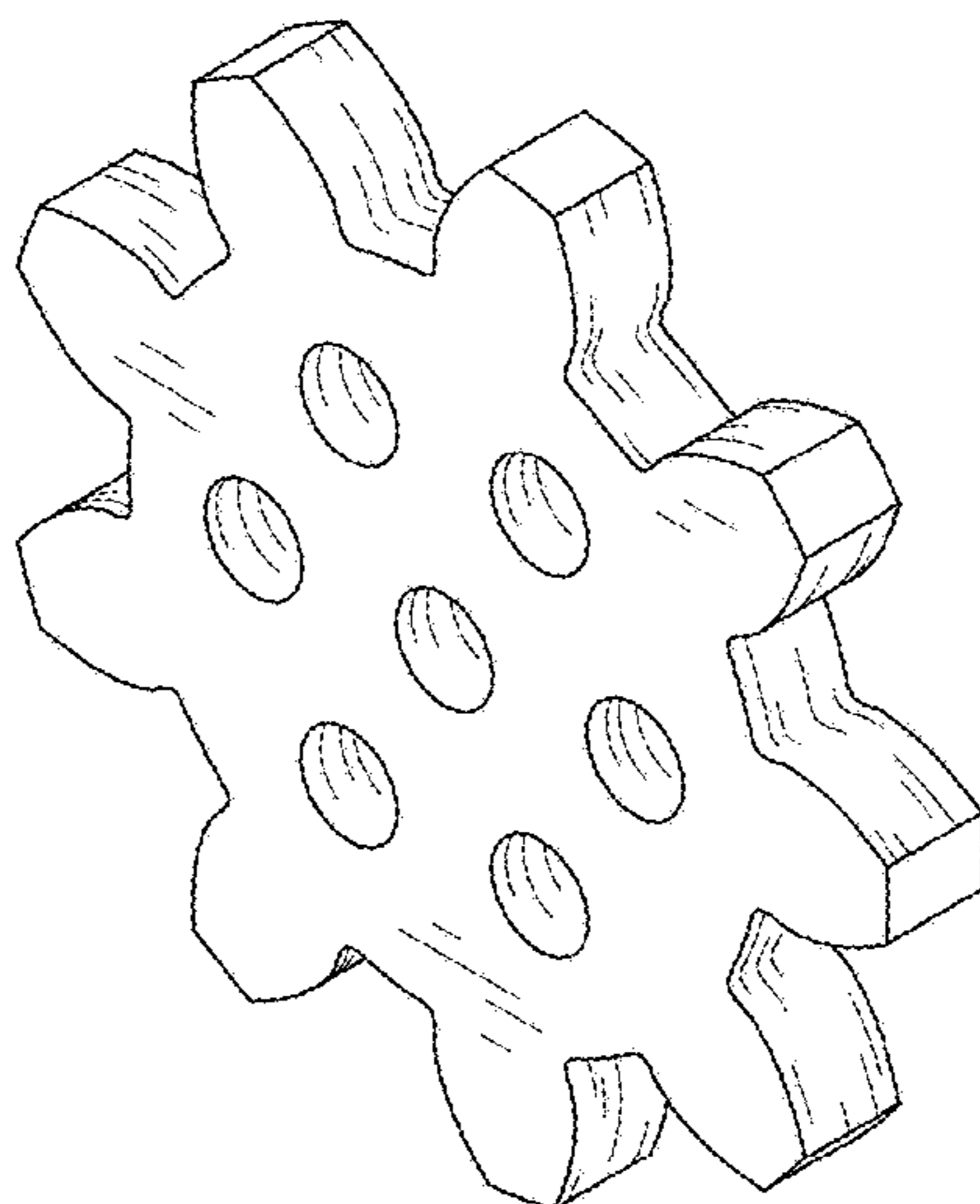

Fig. 10

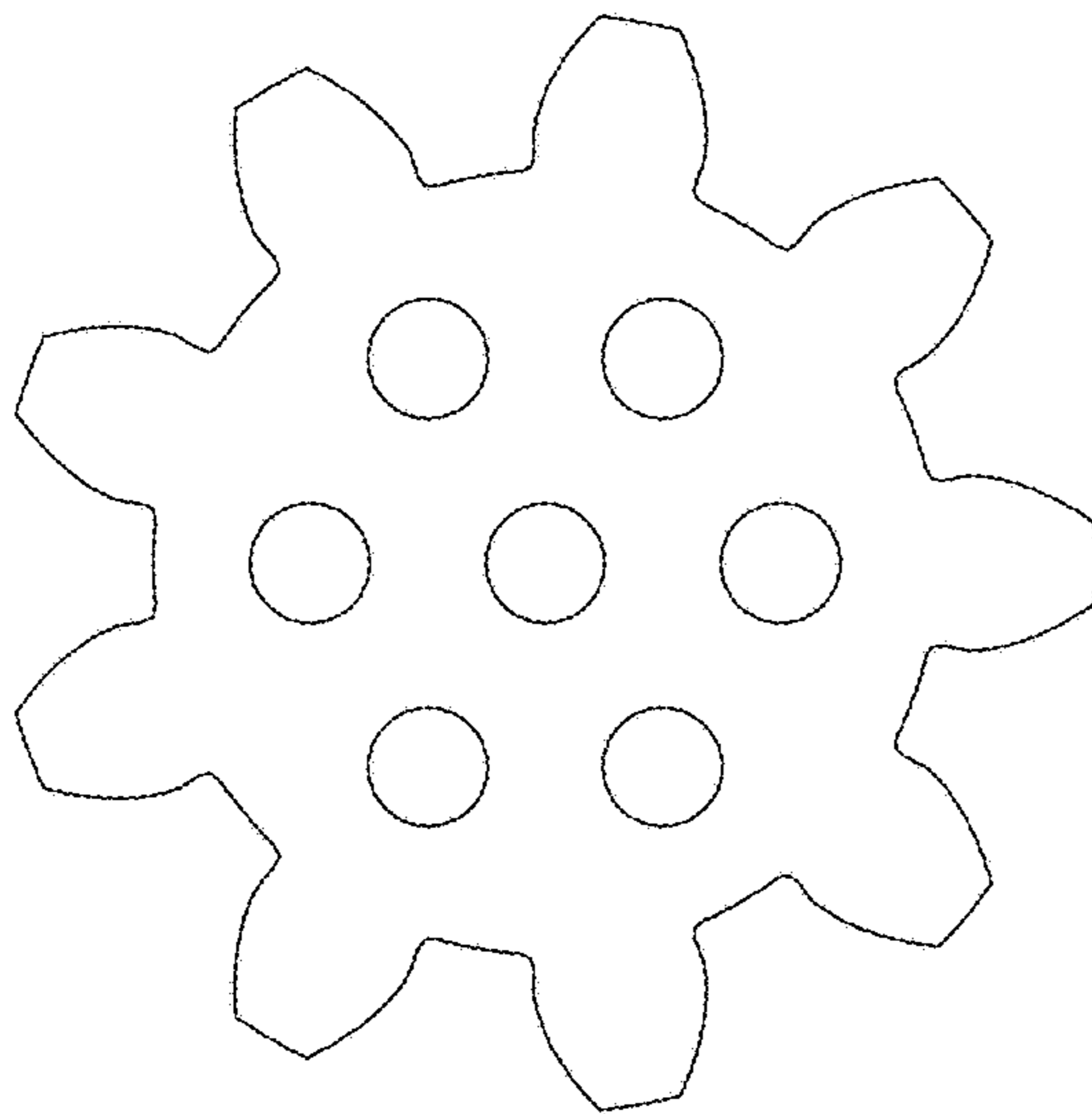

Fig. 11

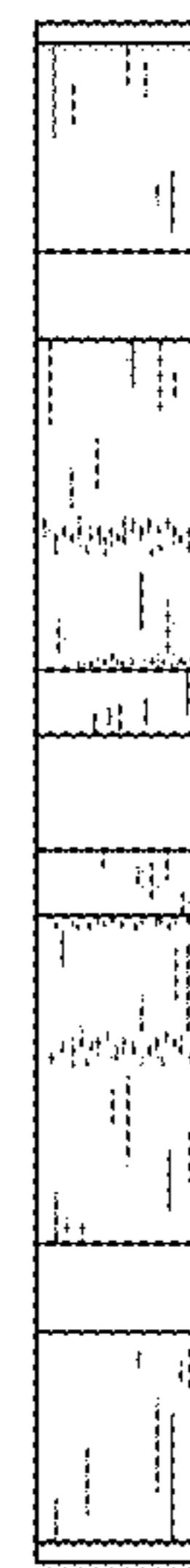

Fig. 12

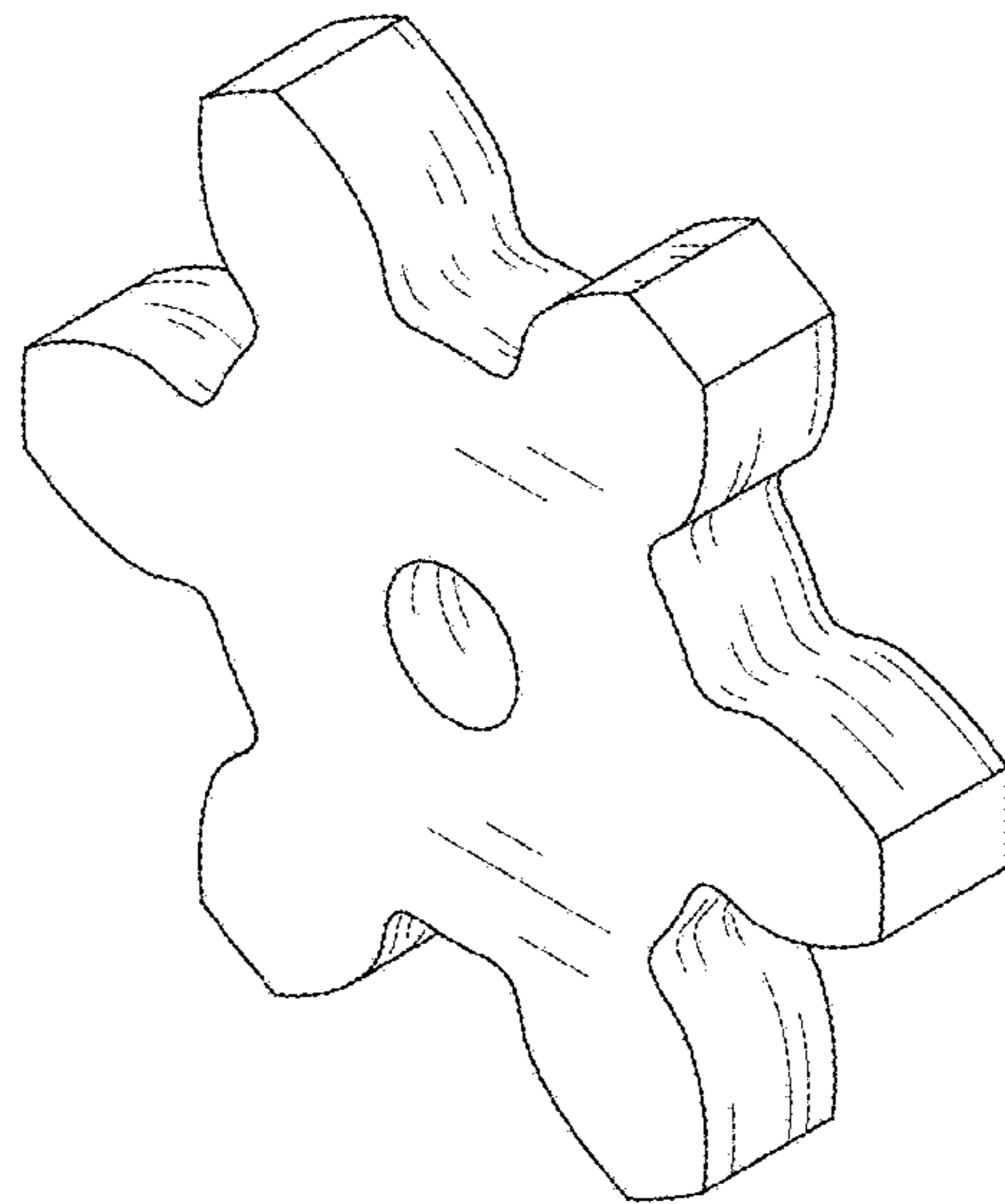

Fig. 13

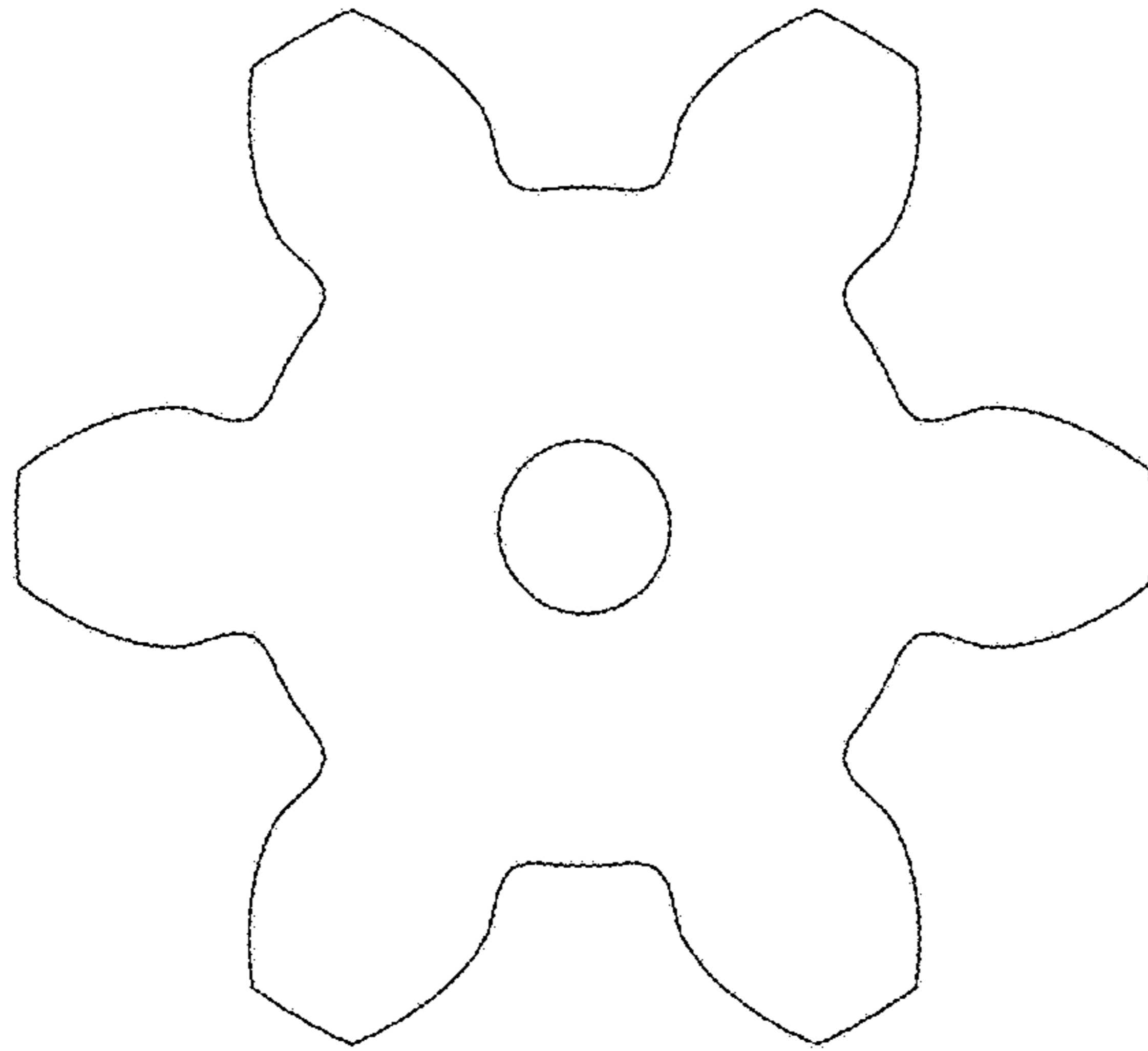

Fig. 14



Fig. 15

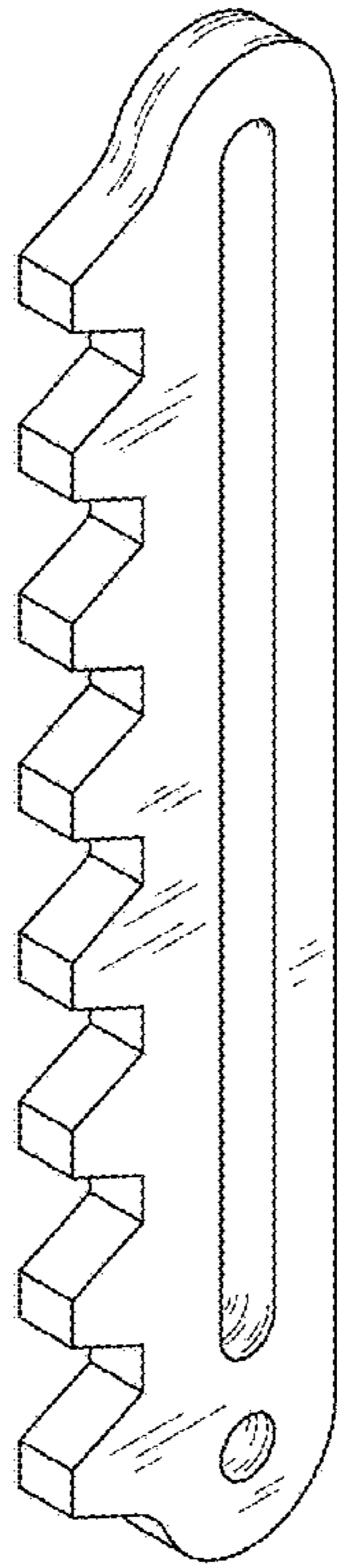

Fig. 16

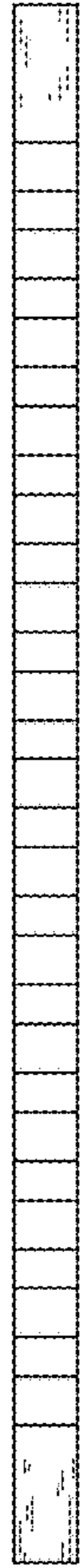

Fig. 17

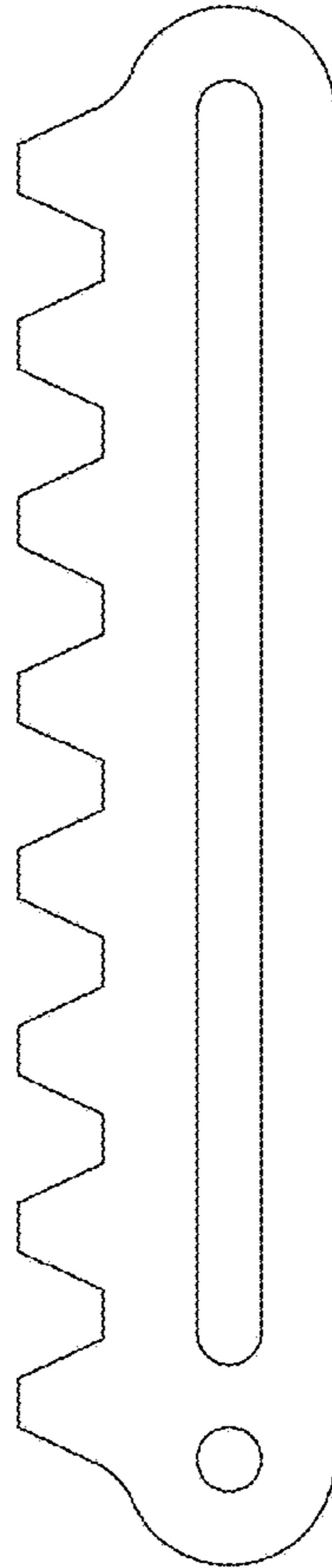

Fig. 18

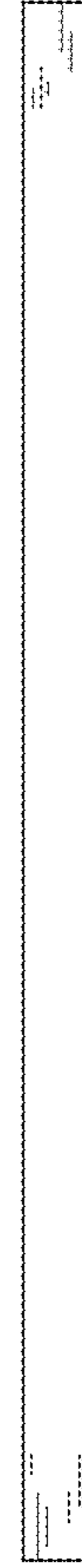

Fig. 19

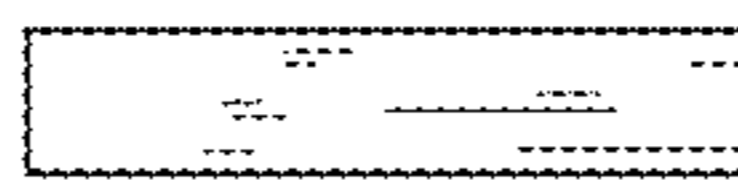

Fig. 20

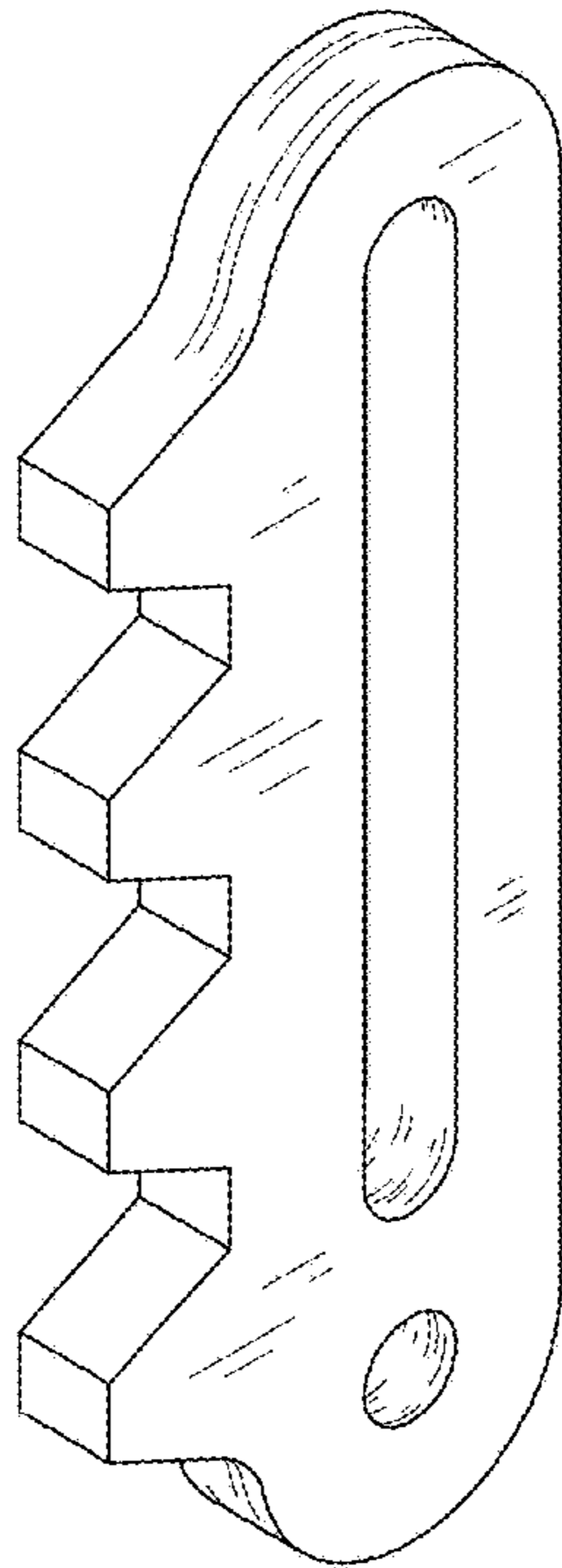

Fig. 21

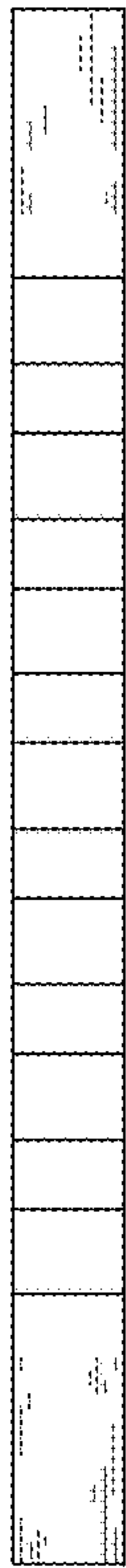

Fig. 22

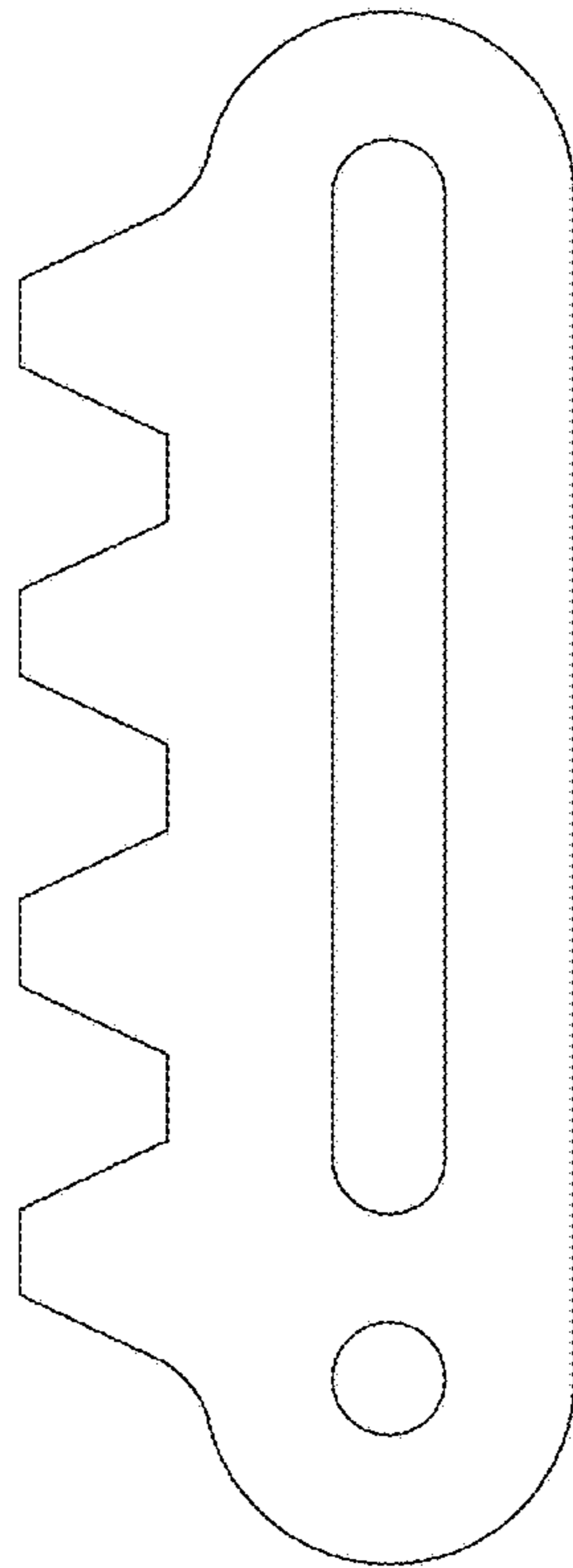

Fig. 23



Fig. 24

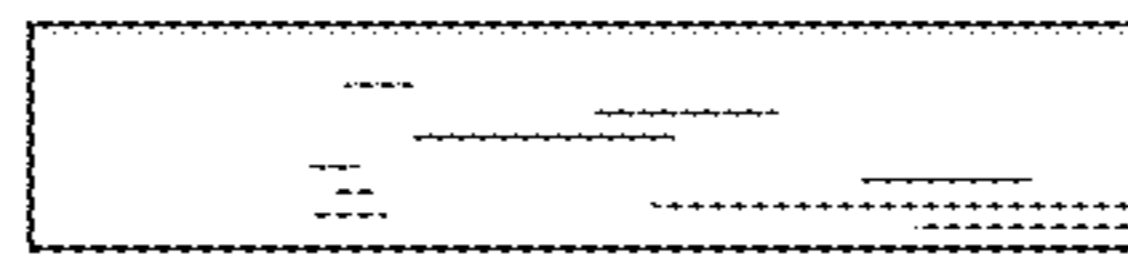

Fig. 25

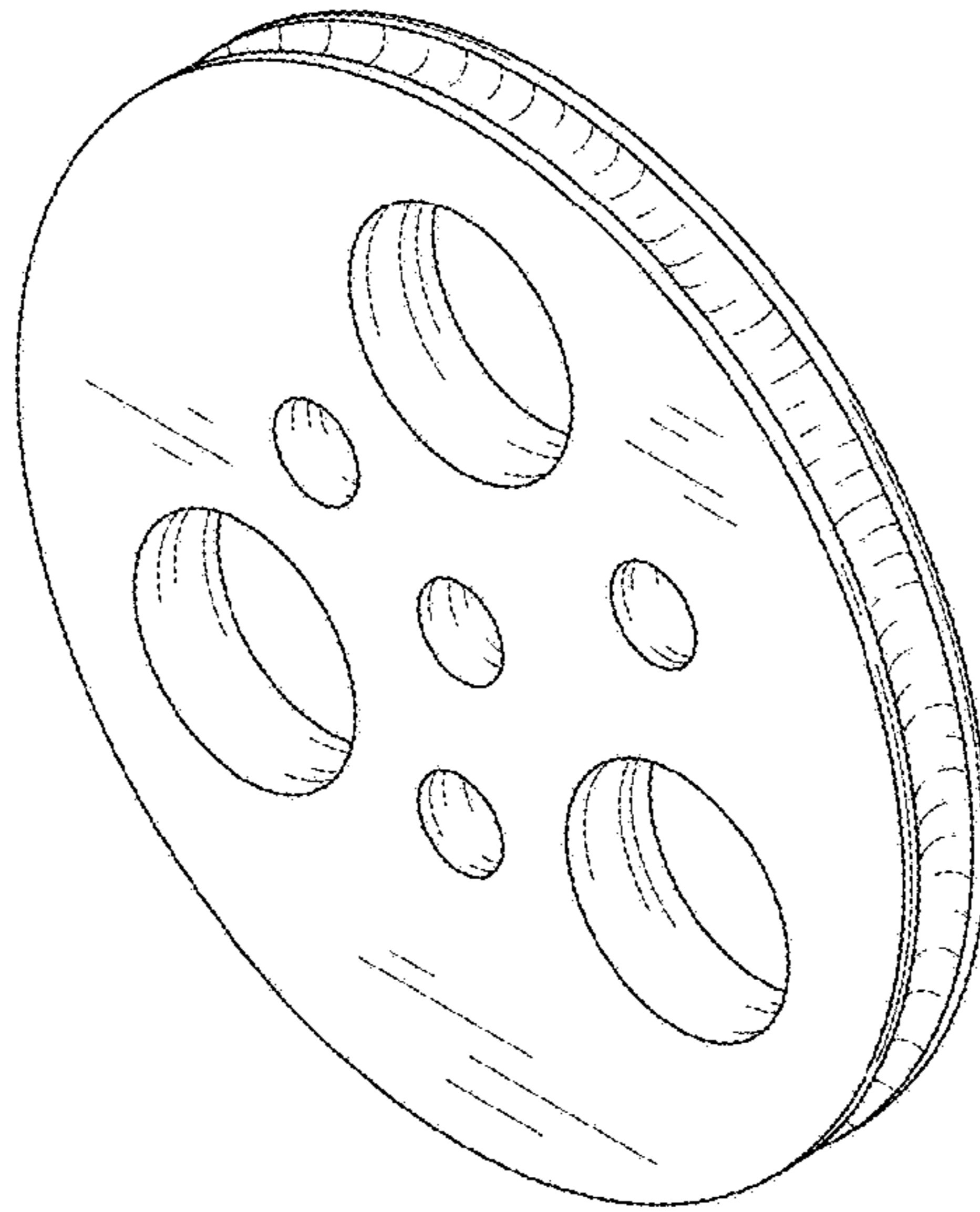

Fig. 26

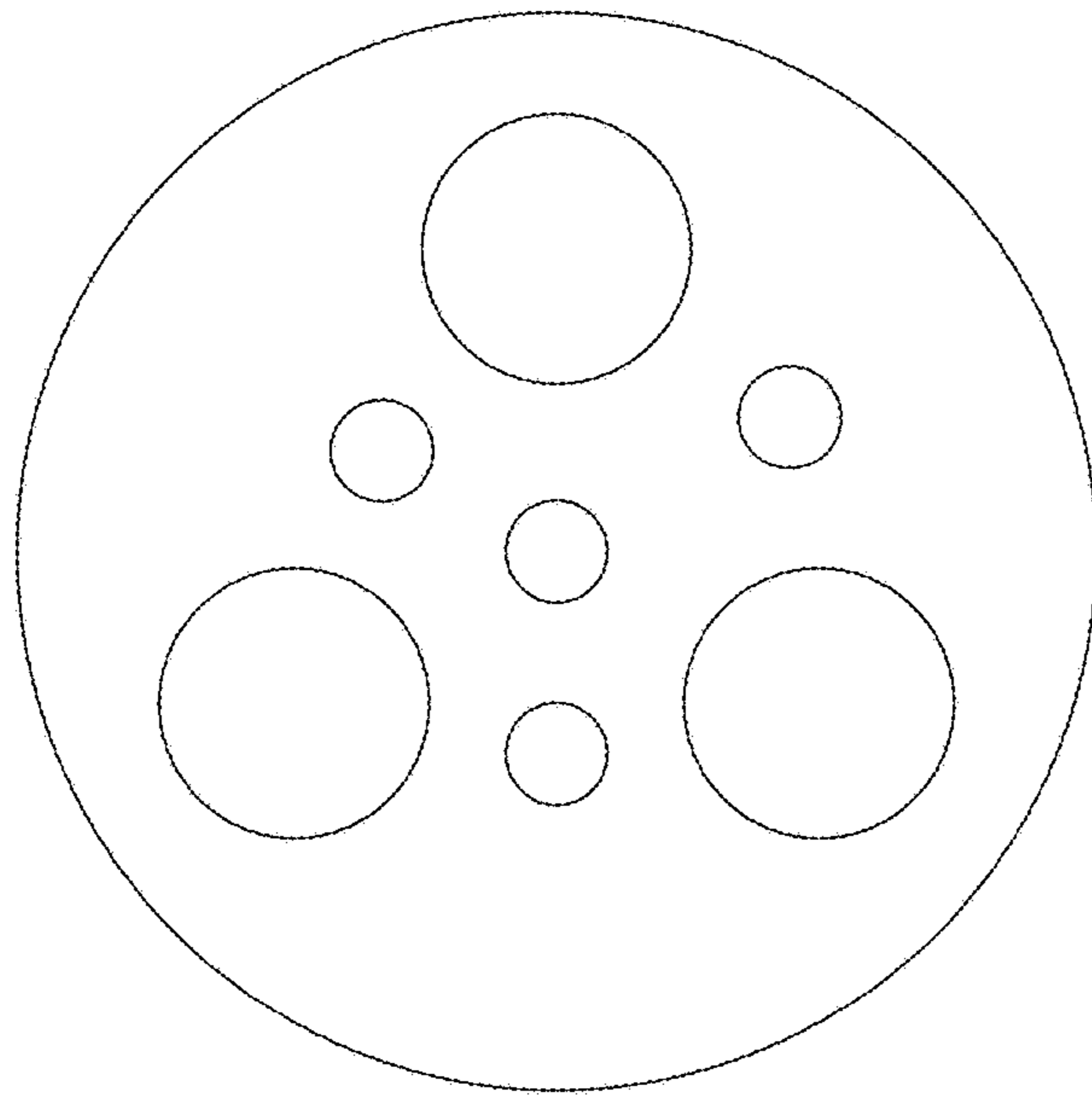

Fig. 27



Fig. 28

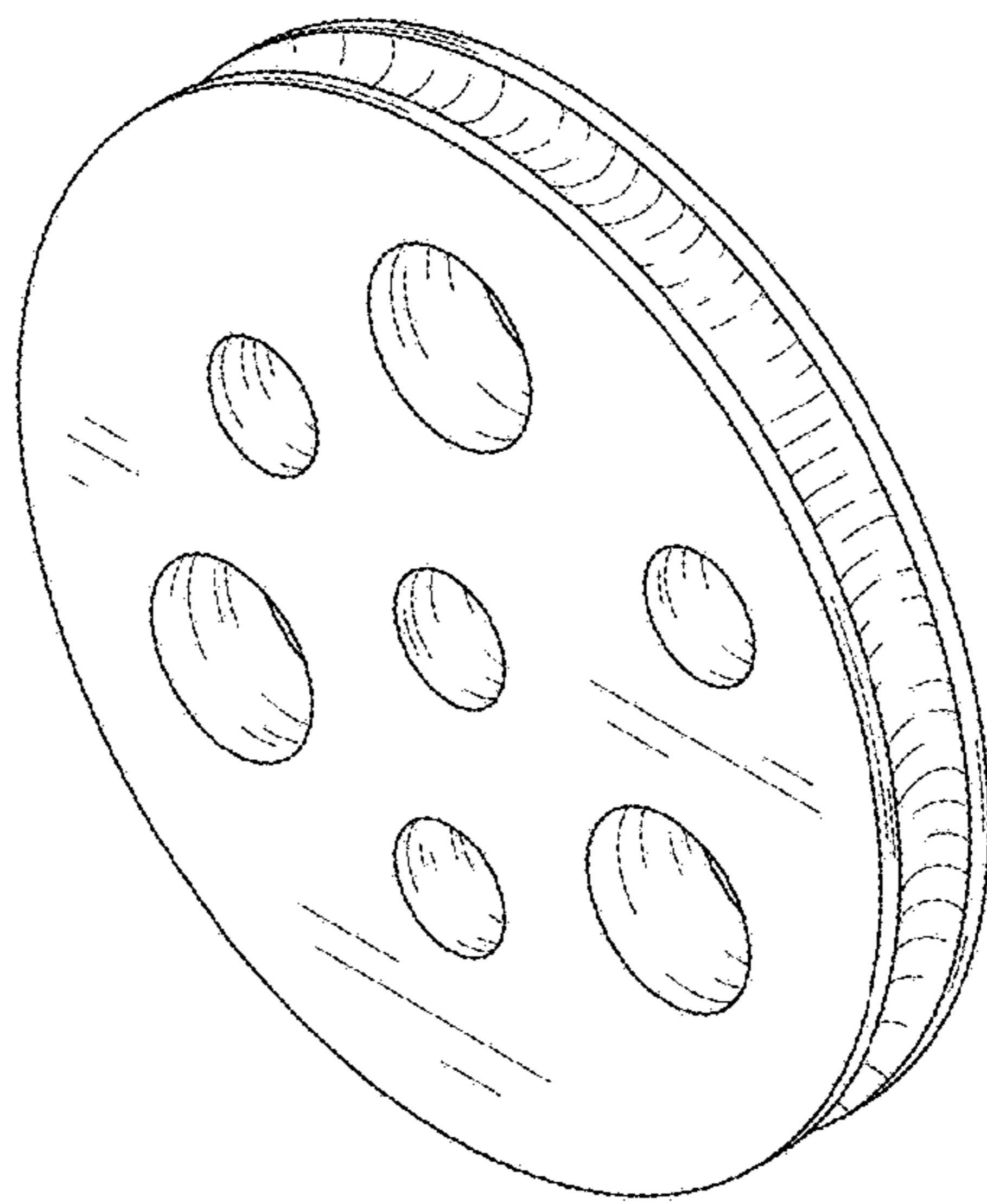

Fig. 29

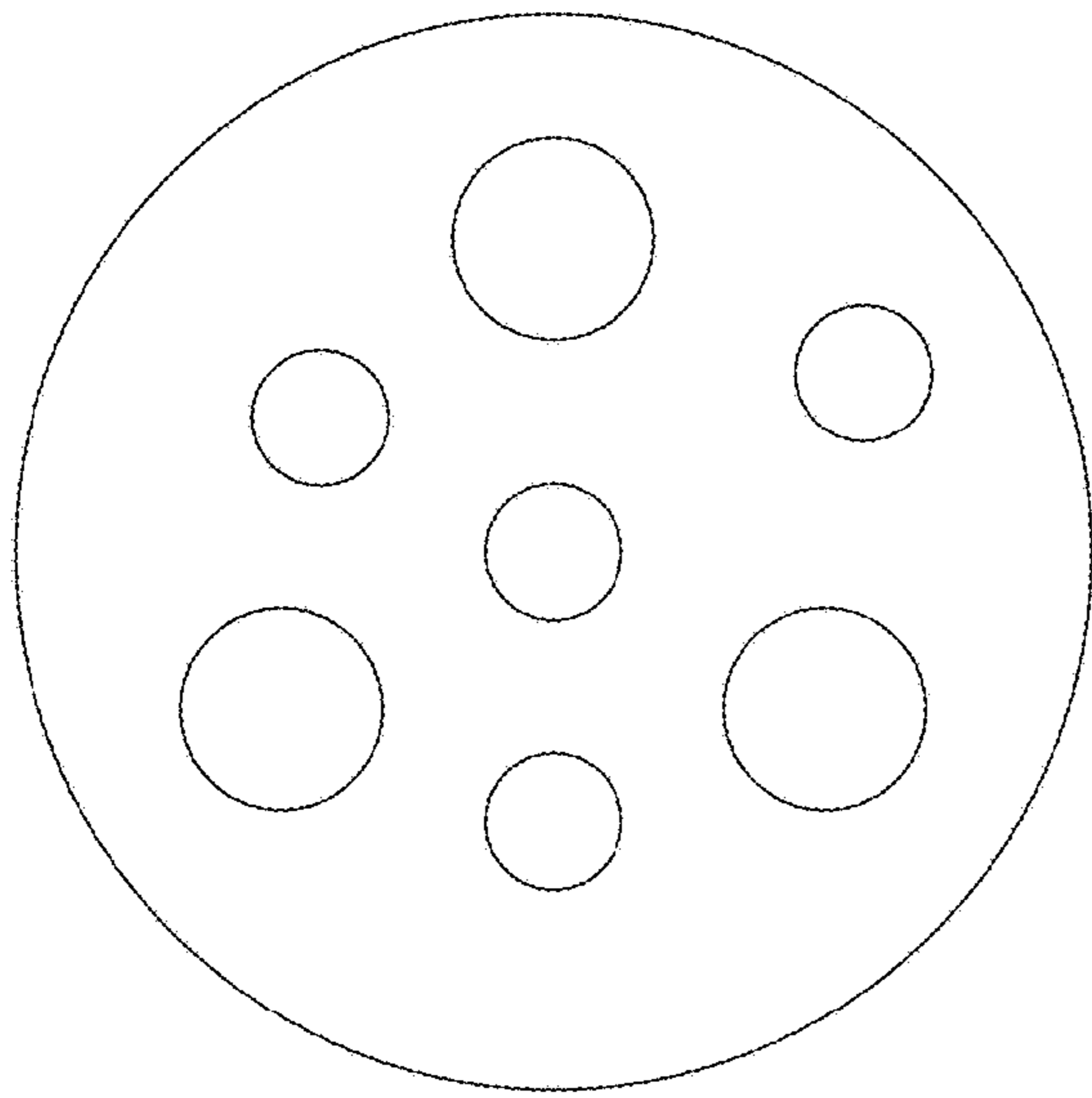

Fig. 30

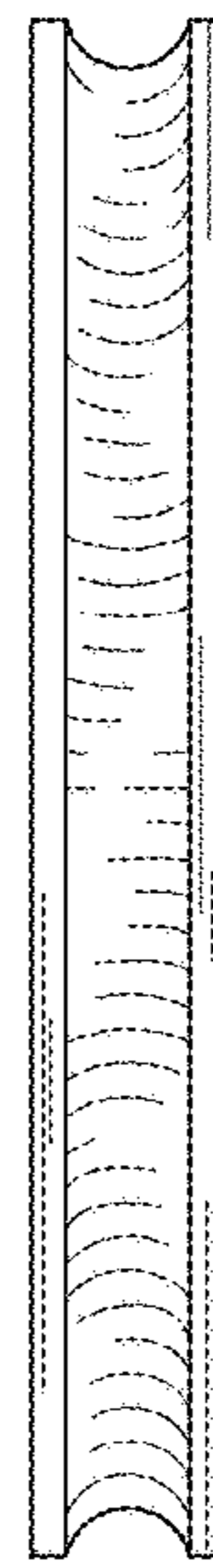

Fig. 31

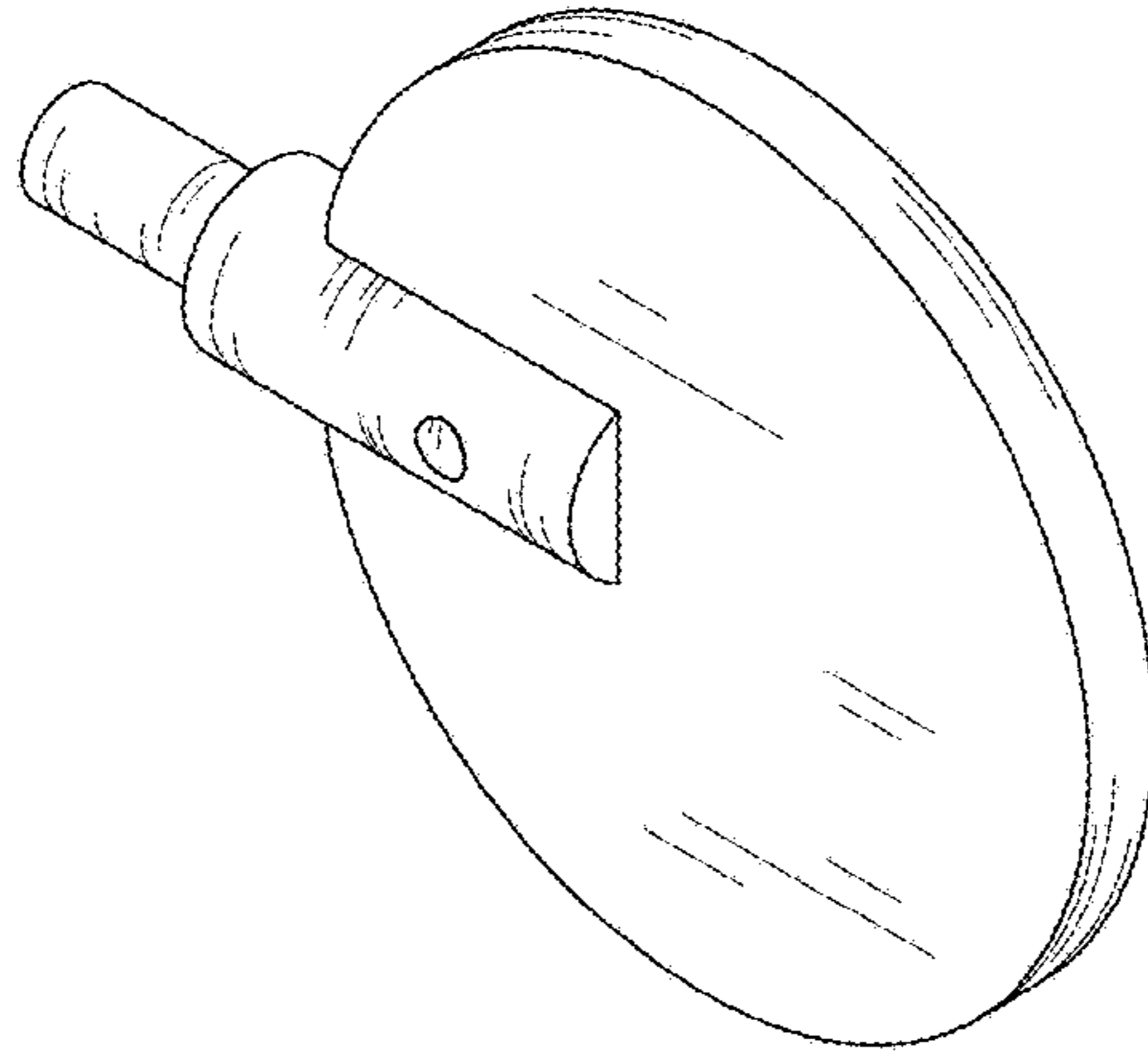

Fig. 32

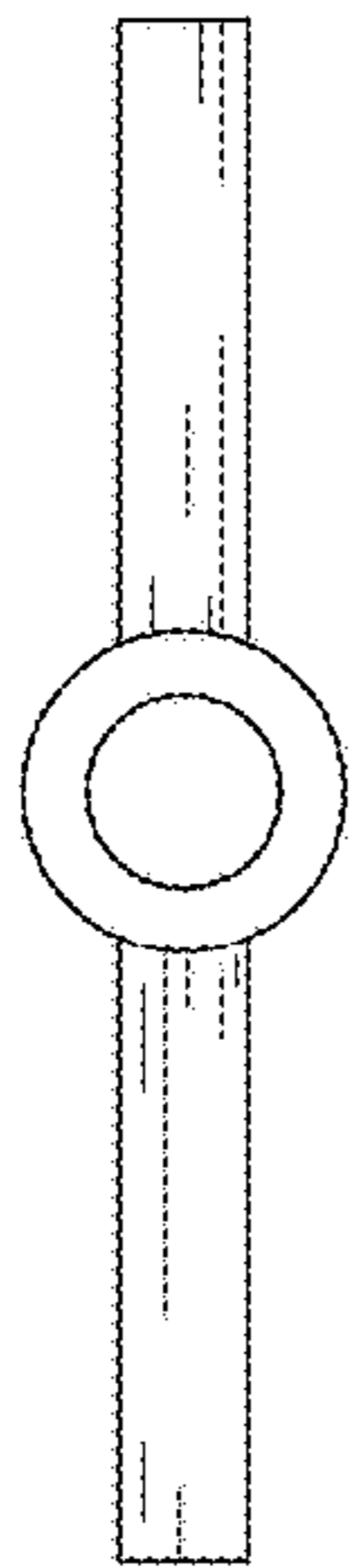

Fig. 33

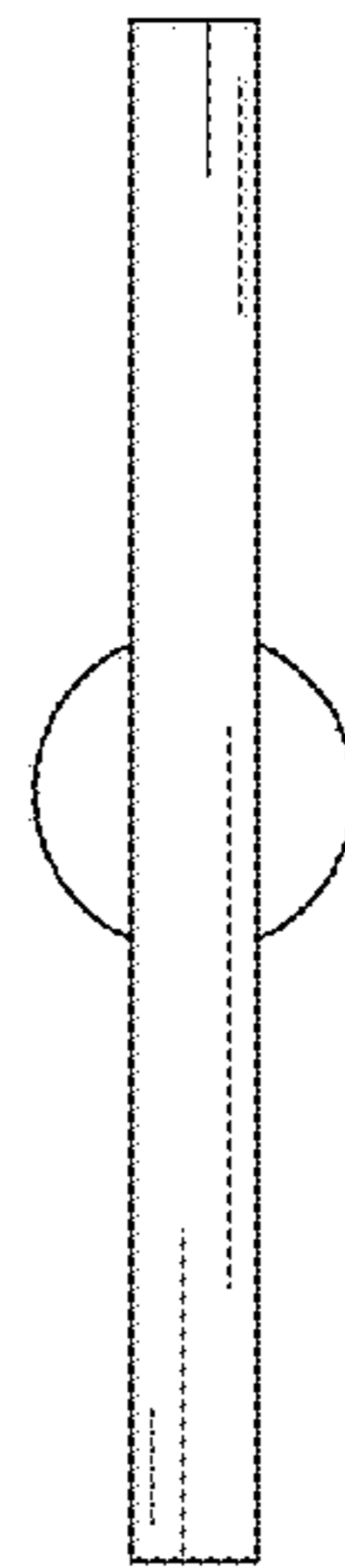

Fig. 34

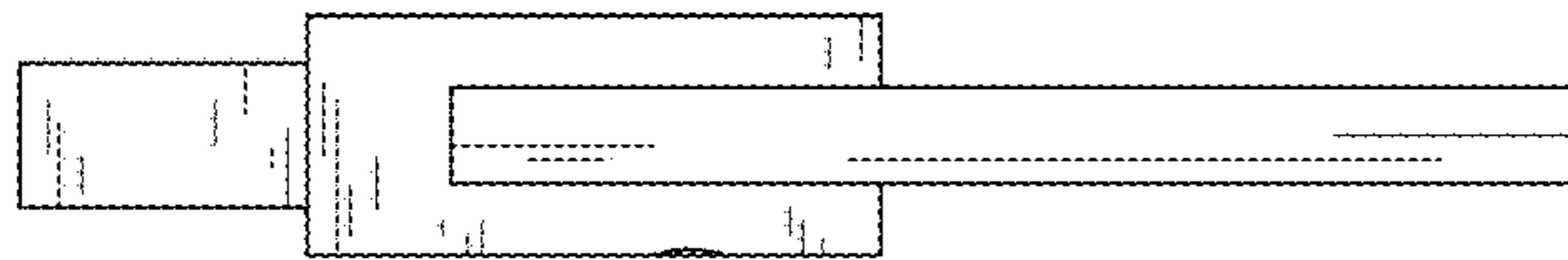

Fig. 35

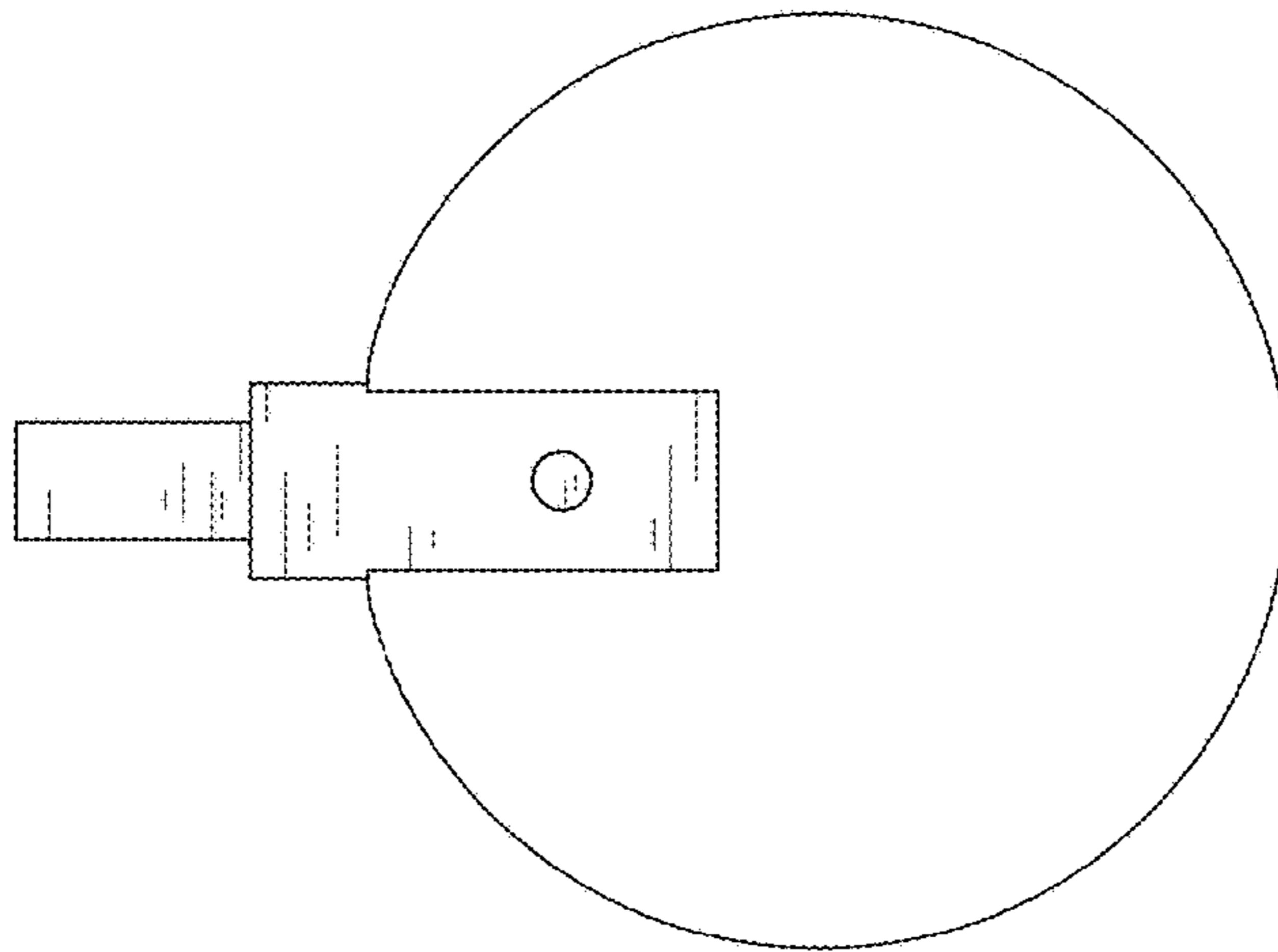

Fig. 36

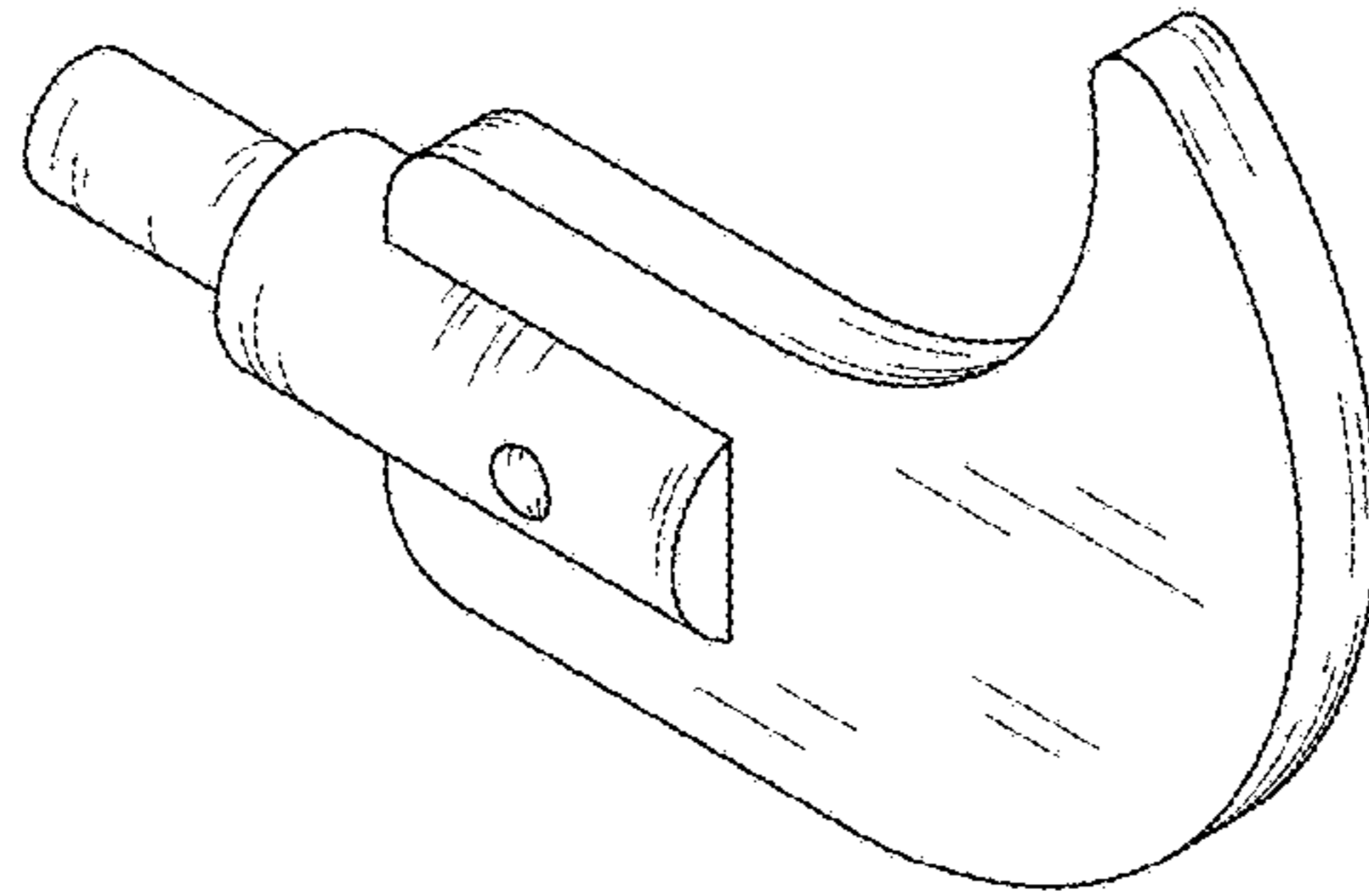

Fig. 37

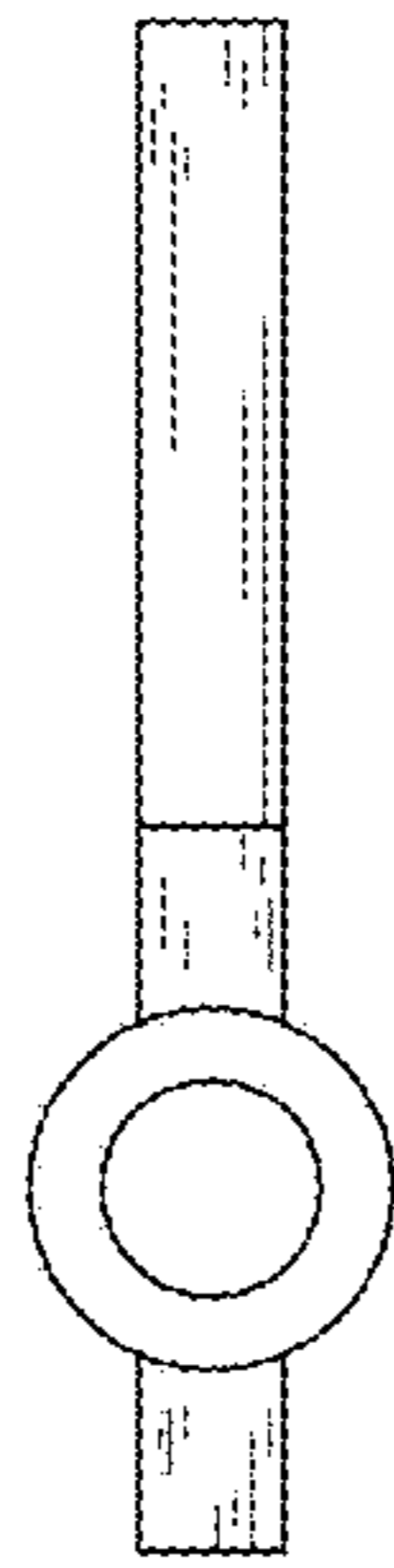

Fig. 38

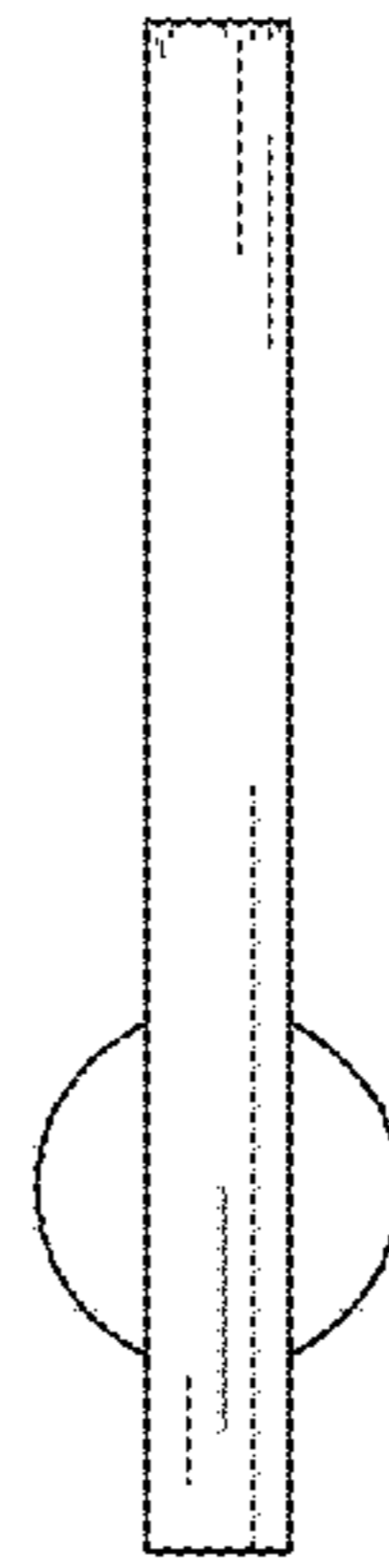

Fig. 39

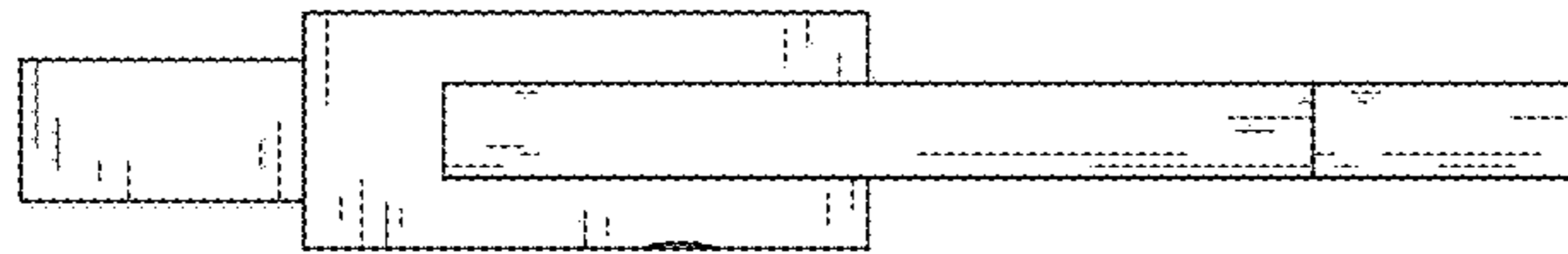

Fig. 40

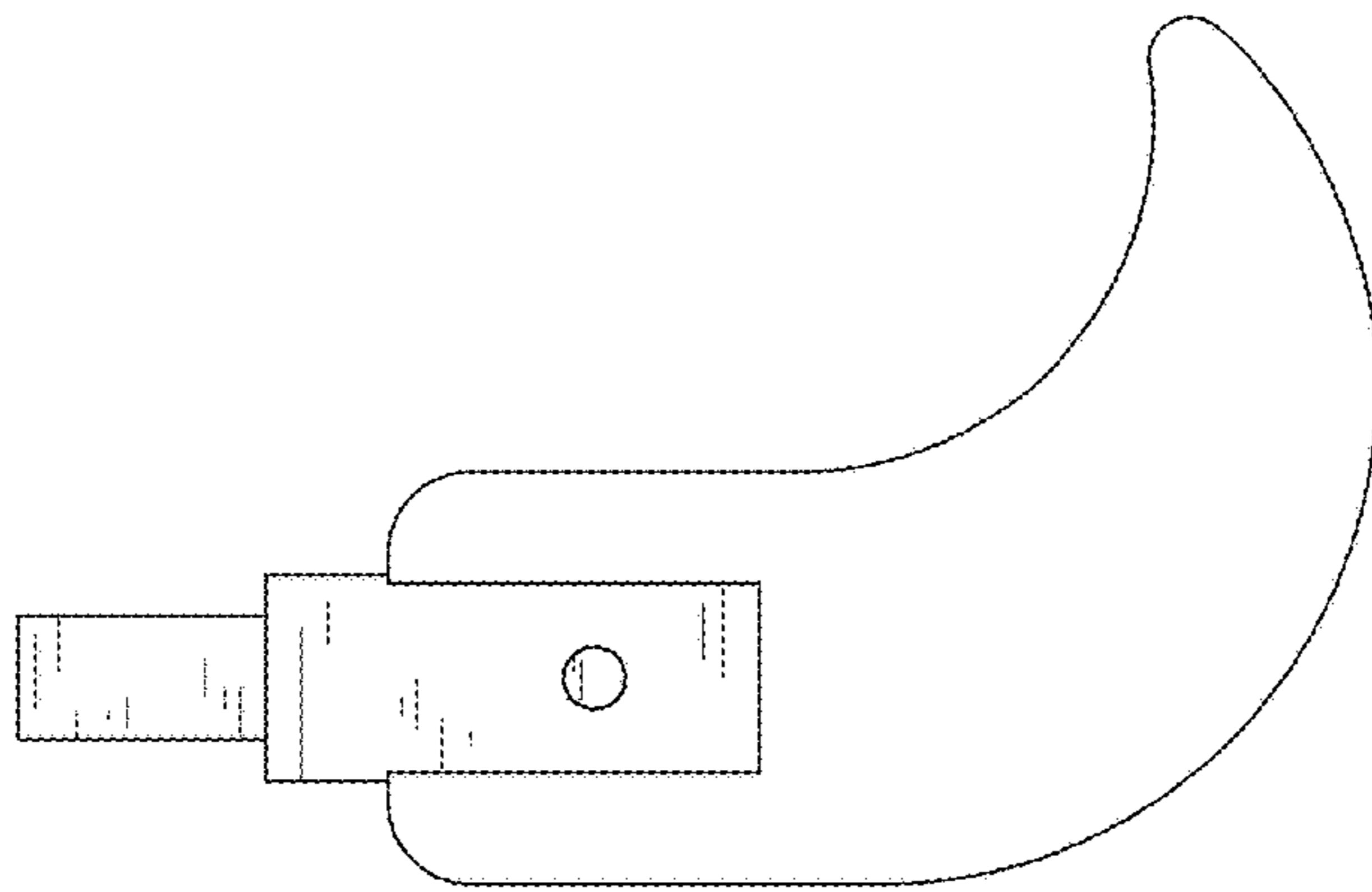

Fig. 41

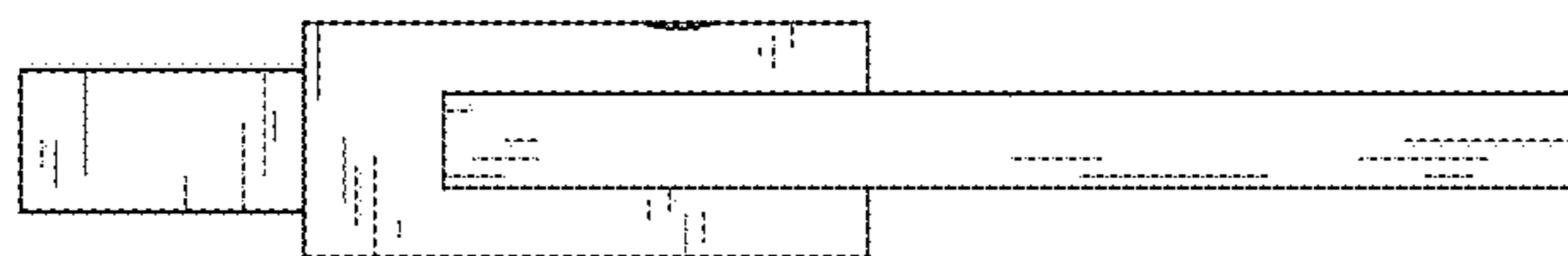

Fig. 42

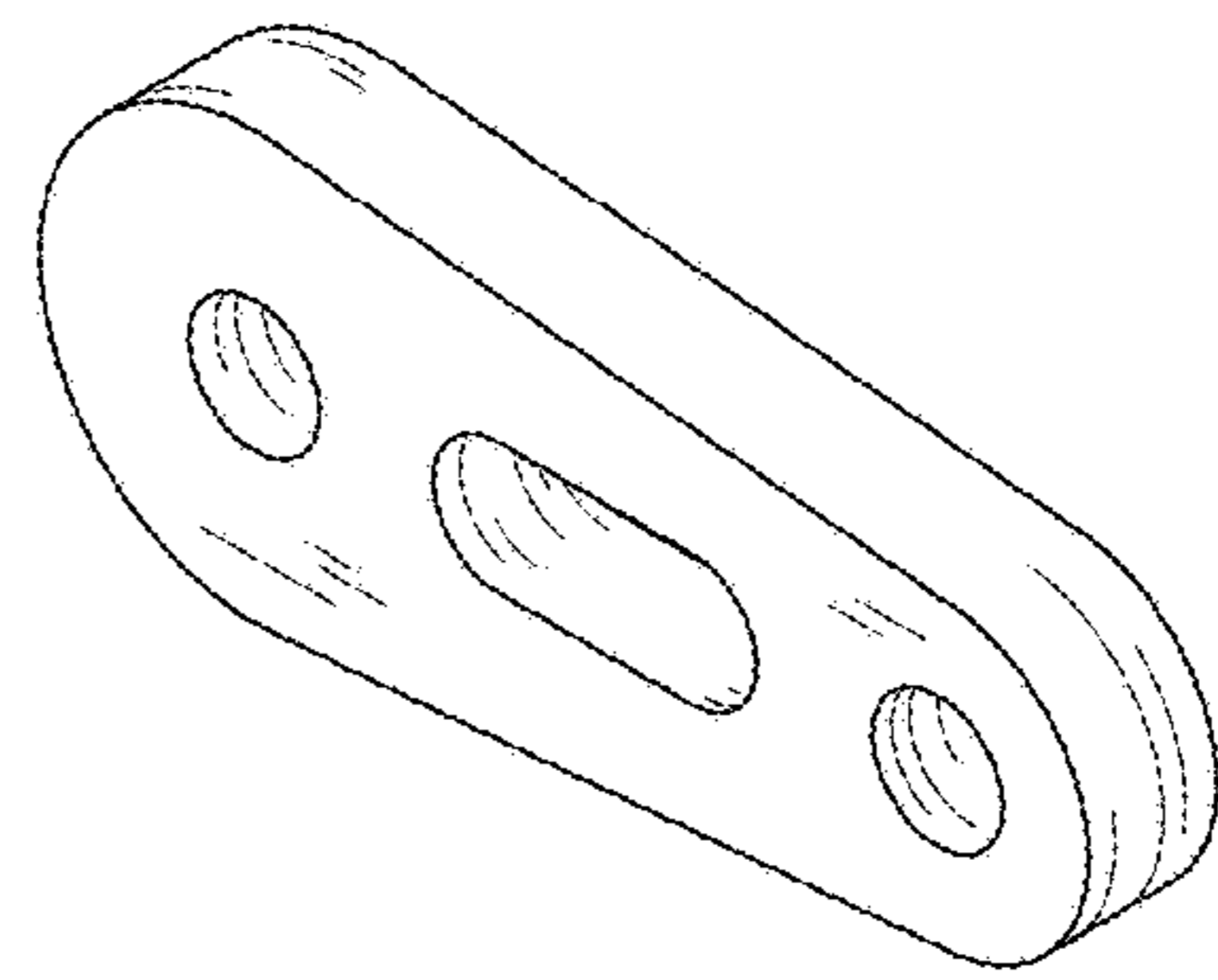

Fig. 43

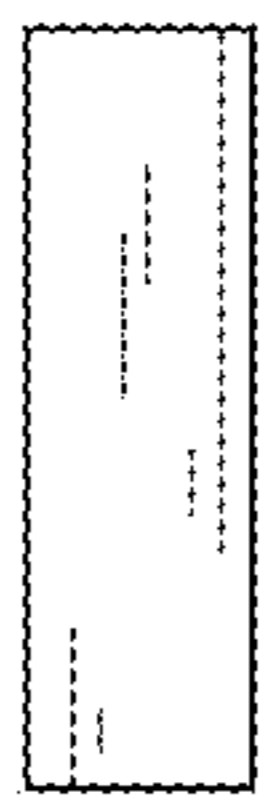

Fig. 44

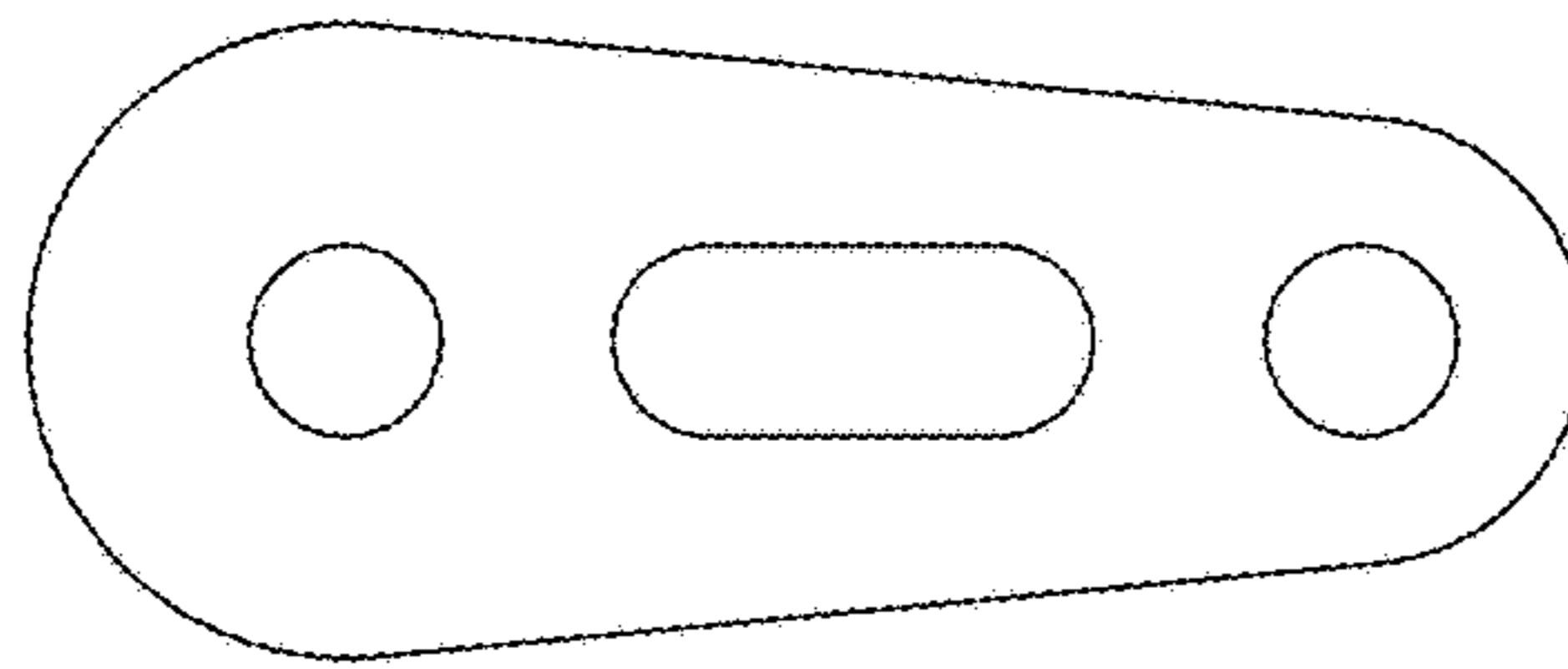

Fig. 45



Fig. 46



Fig. 47

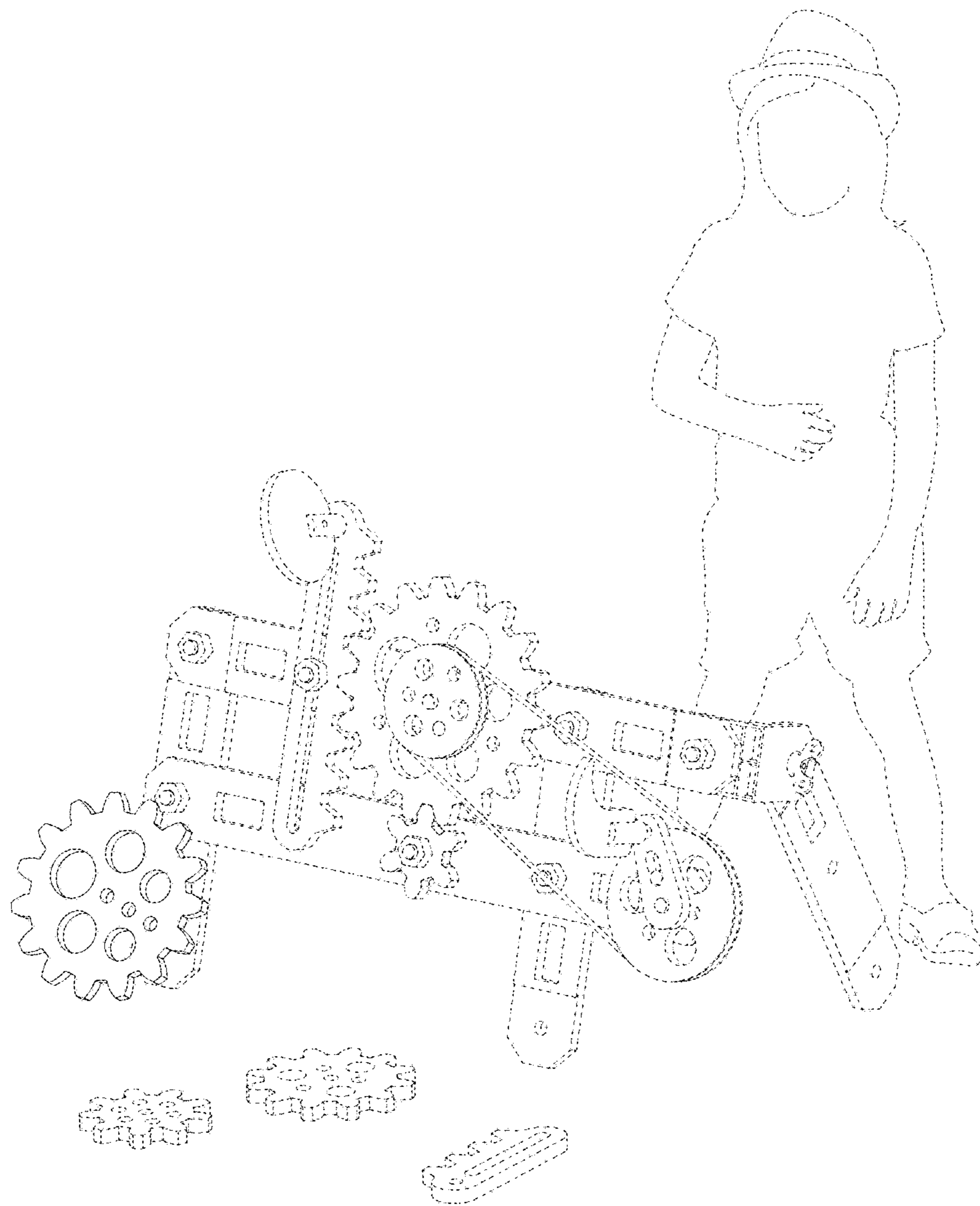

Fig. 48