



US00D865044S

(12) **United States Design Patent**
Tatsumi

(10) **Patent No.:** **US D865,044 S**

(45) **Date of Patent:** **** Oct. 29, 2019**

(54) **PIANO PERFORMANCE CONTROLLER**

(71) Applicant: **YAMAHA CORPORATION**,
Hamamatsu-shi (JP)

(72) Inventor: **Keizo Tatsumi**, Hamamatsu (JP)

(73) Assignee: **YAMAHA CORPORATION**,
Hamamatsu-shi, Shizuoka (JP)

(**) Term: **15 Years**

(21) Appl. No.: **29/643,601**

(22) Filed: **Apr. 10, 2018**

(51) **LOC (12) Cl.** **17-01**

(52) **U.S. Cl.**
USPC **D17/9**

(58) **Field of Classification Search**
USPC D17/1, 5, 7, 9; D21/405, 409; D14/188
CPC G10B 3/12; G10B 3/14
See application file for complete search history.

(56) **References Cited**

U.S. PATENT DOCUMENTS

D278,153 S *	3/1985	Ohta	D17/9
D349,719 S *	8/1994	Ohta	D14/188
D501,659 S *	2/2005	Yamaji	D14/188
D567,240 S *	4/2008	Griffin	D14/392
D578,505 S *	10/2008	Tejima	D14/188
D636,375 S *	4/2011	Kim	D14/188

D658,153 S *	4/2012	Woo	D14/188
D800,829 S *	10/2017	Kouthoofd	D17/1
D810,044 S *	2/2018	Ohmachi	D14/188
D840,466 S *	2/2019	Kitamura	D17/99

* cited by examiner

Primary Examiner — R. Johnson

(74) *Attorney, Agent, or Firm* — Sughrue Mion, PLLC

(57) **CLAIM**

The ornamental design for a piano performance controller, as shown and described.

DESCRIPTION

FIG. 1 is a perspective view of the front, bottom and right side of a piano performance controller showing my new design;

FIG. 2 is a front view thereof;

FIG. 3 is a rear view thereof;

FIG. 4 is a left side view thereof;

FIG. 5 is a right side view thereof;

FIG. 6 is a top view thereof; and,

FIG. 7 is a bottom view thereof.

The broken line showing of the piano performance controller is included for the purpose of illustrating portions of the piano performance controller and forms no part of the claimed design.

1 Claim, 5 Drawing Sheets

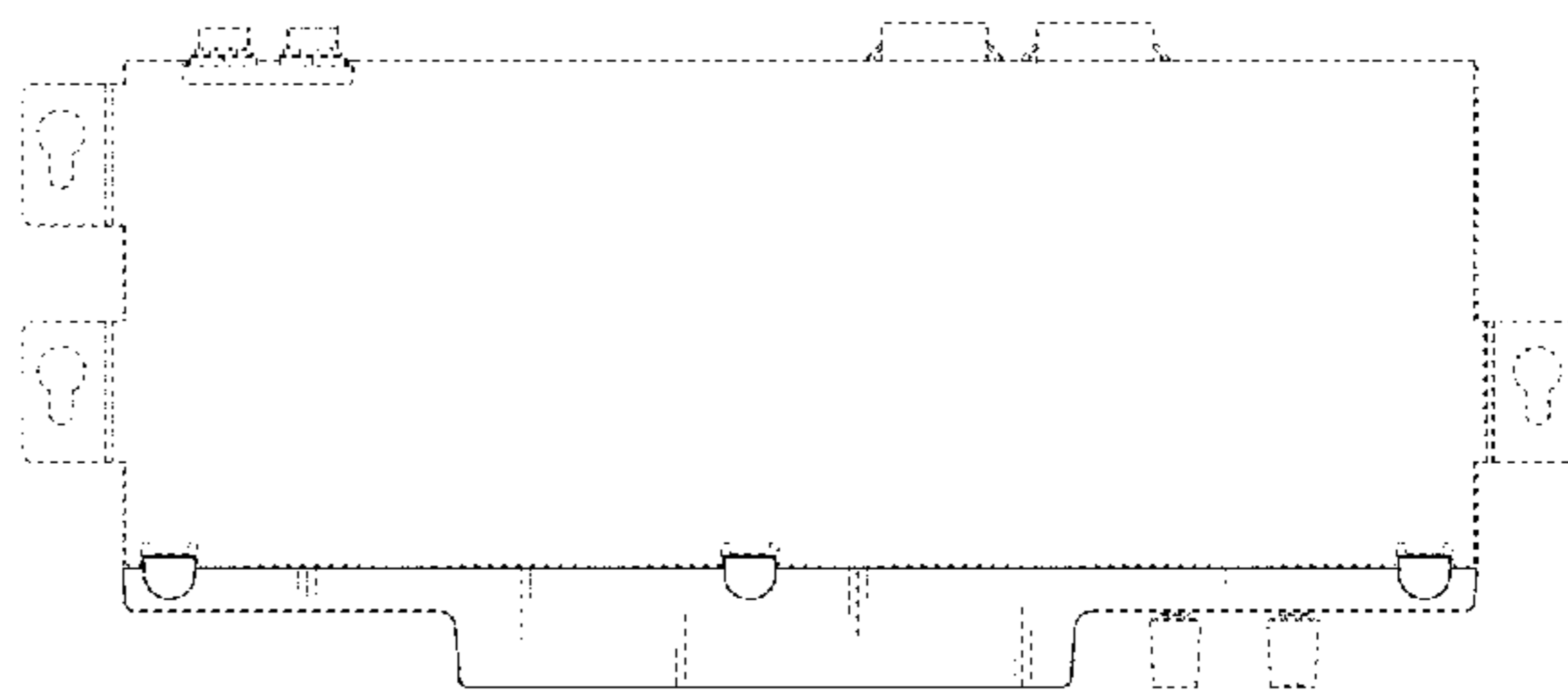
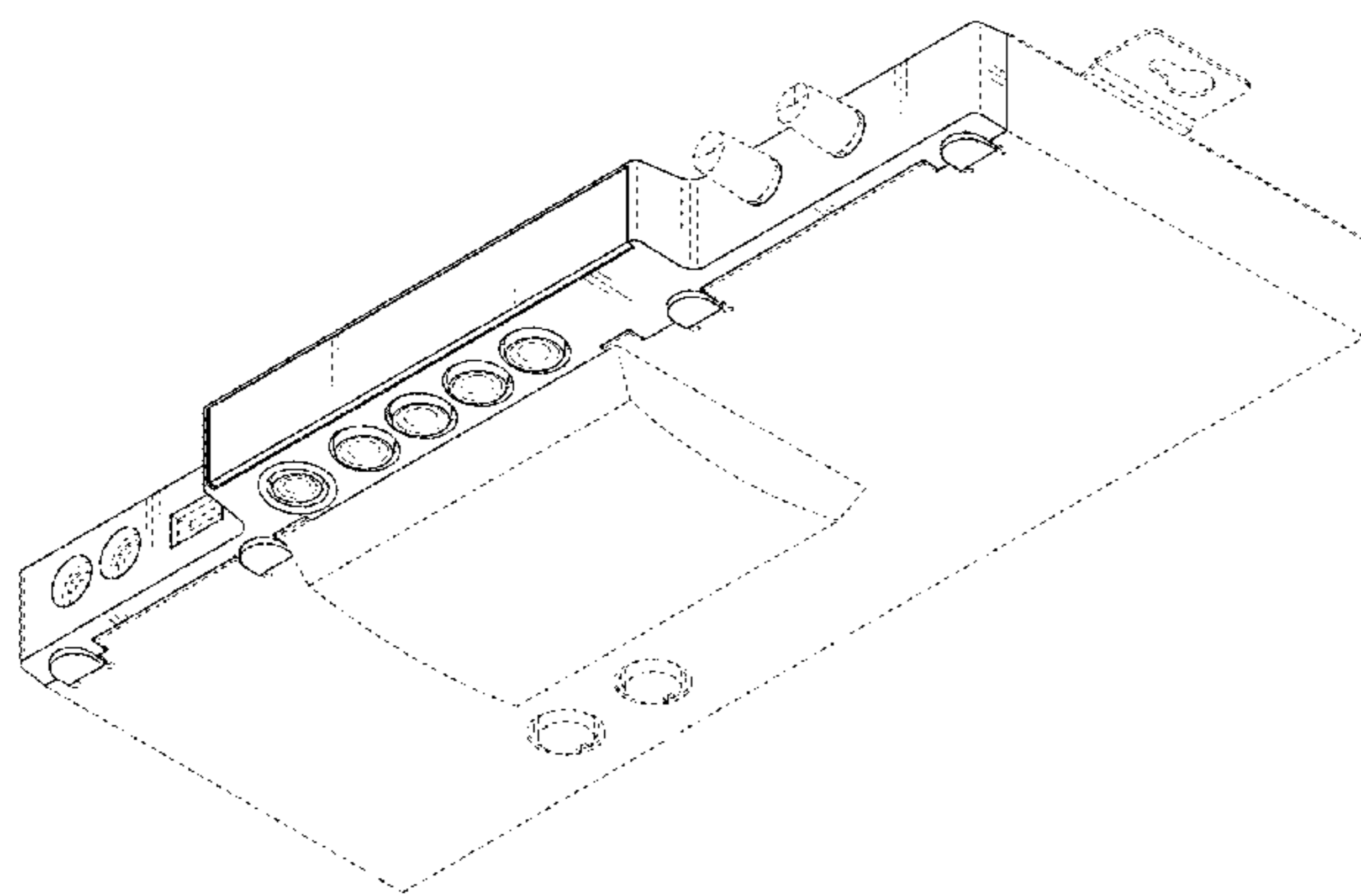

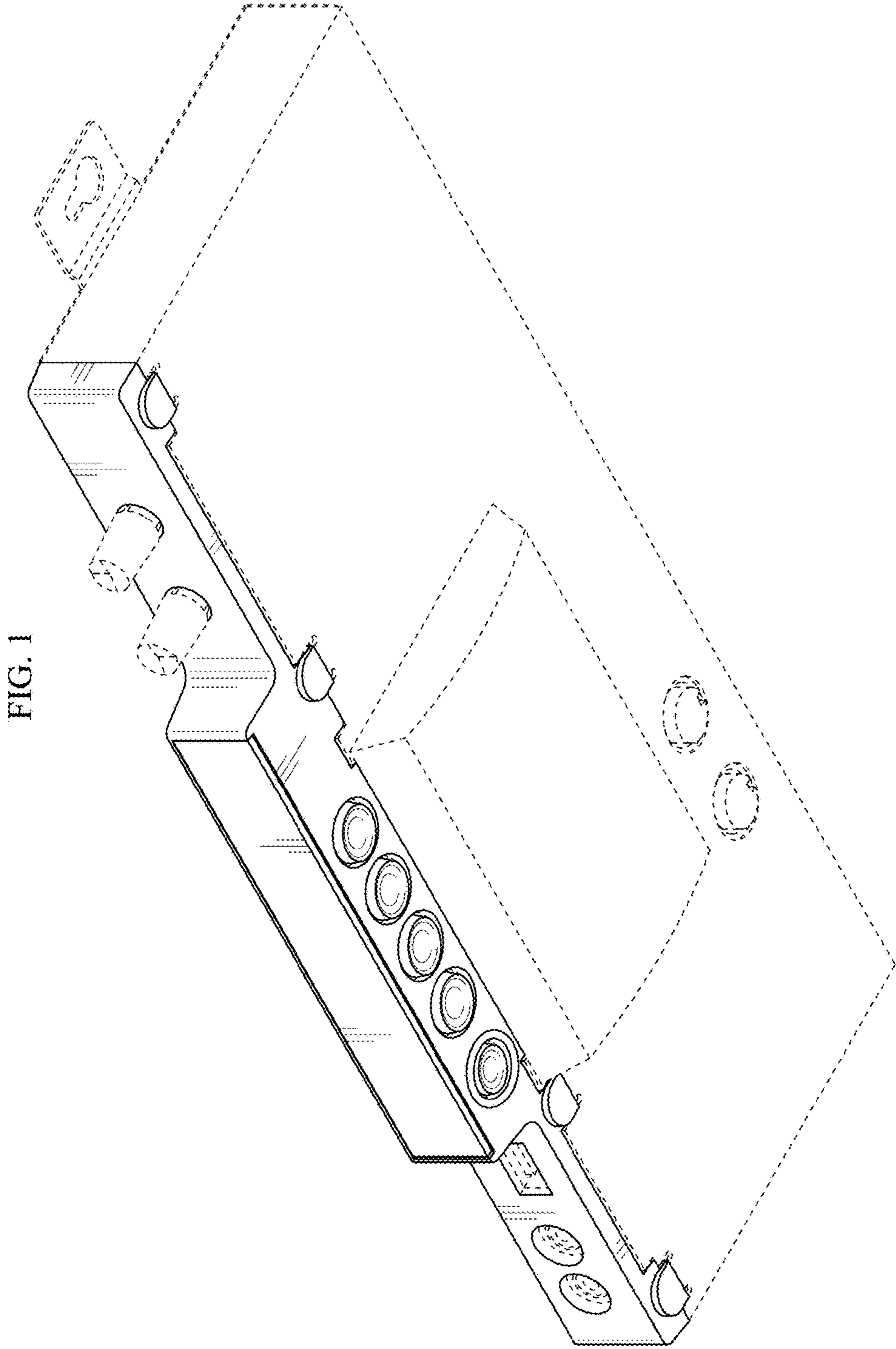

FIG. 2

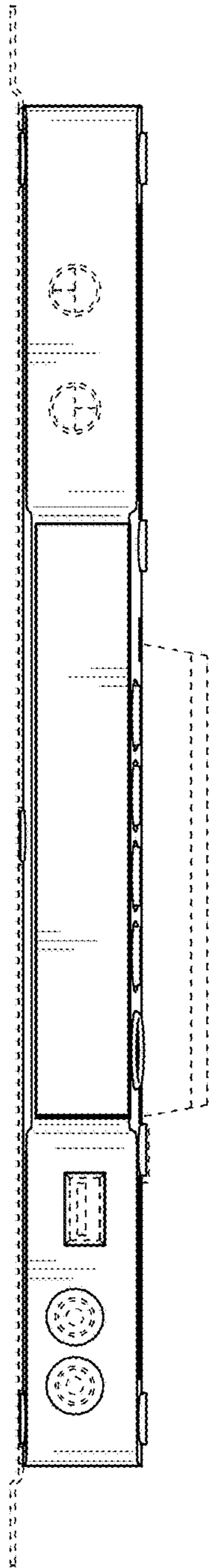

FIG. 3

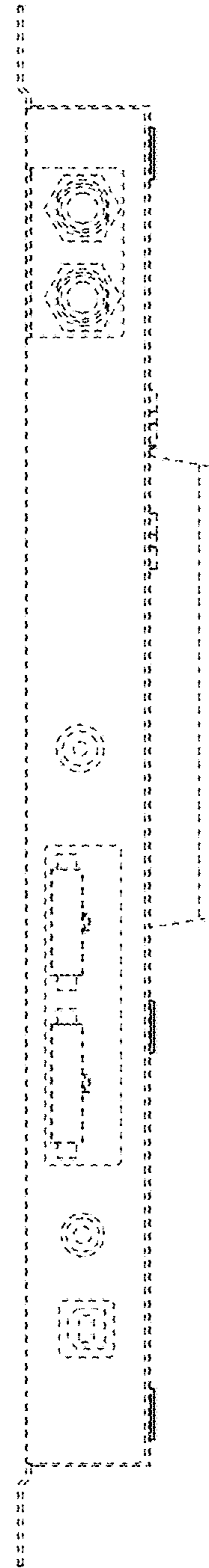

FIG. 5

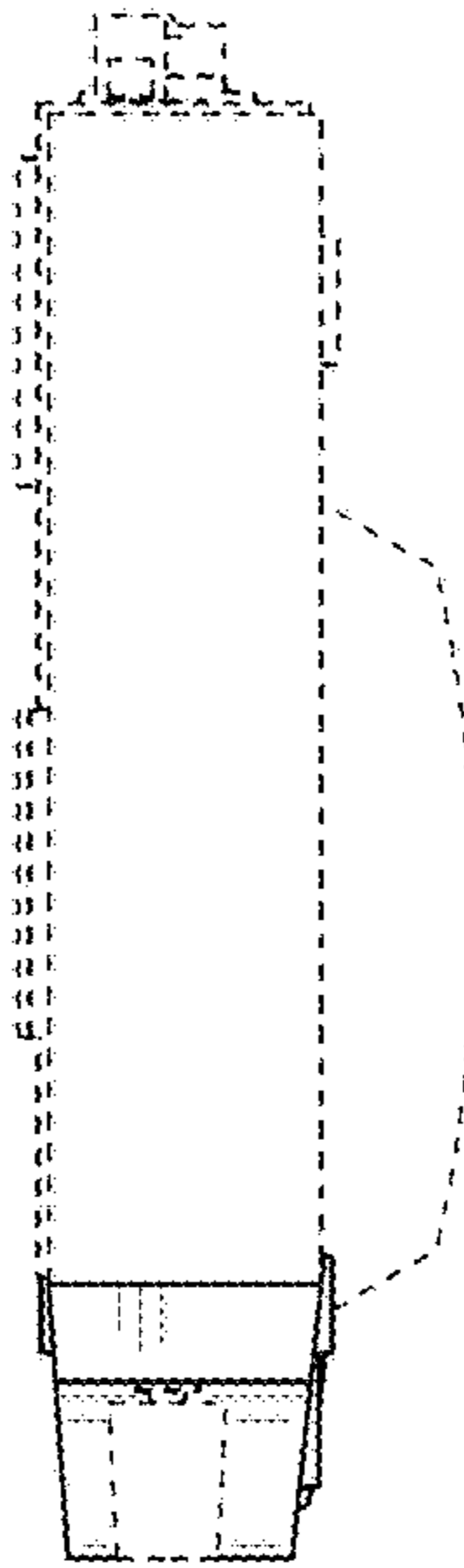

FIG. 4

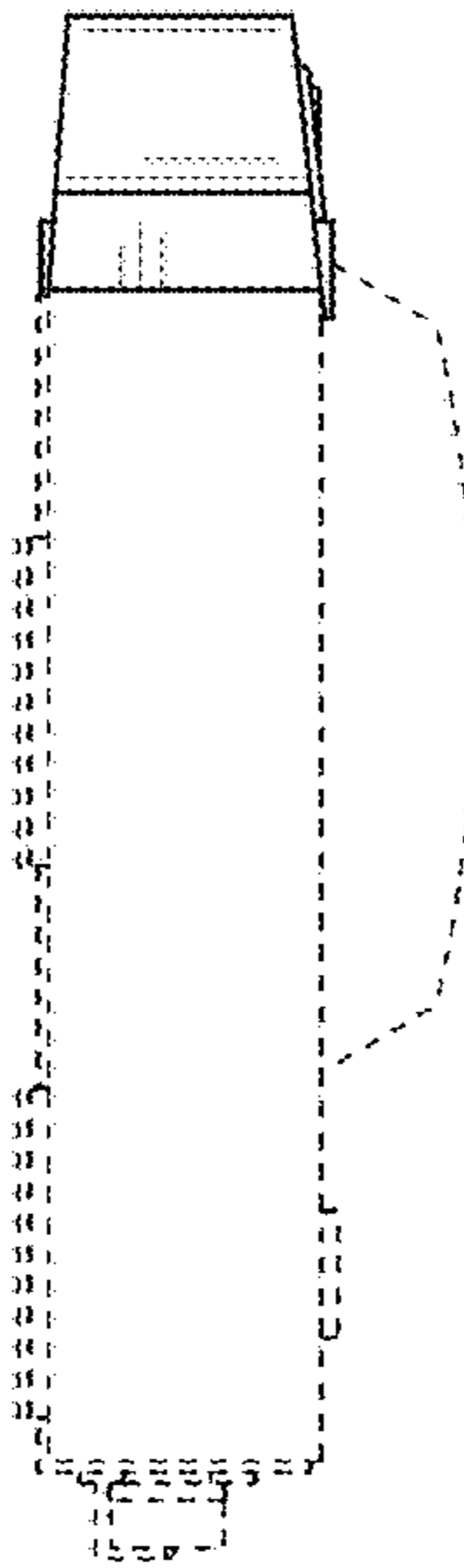

FIG. 6

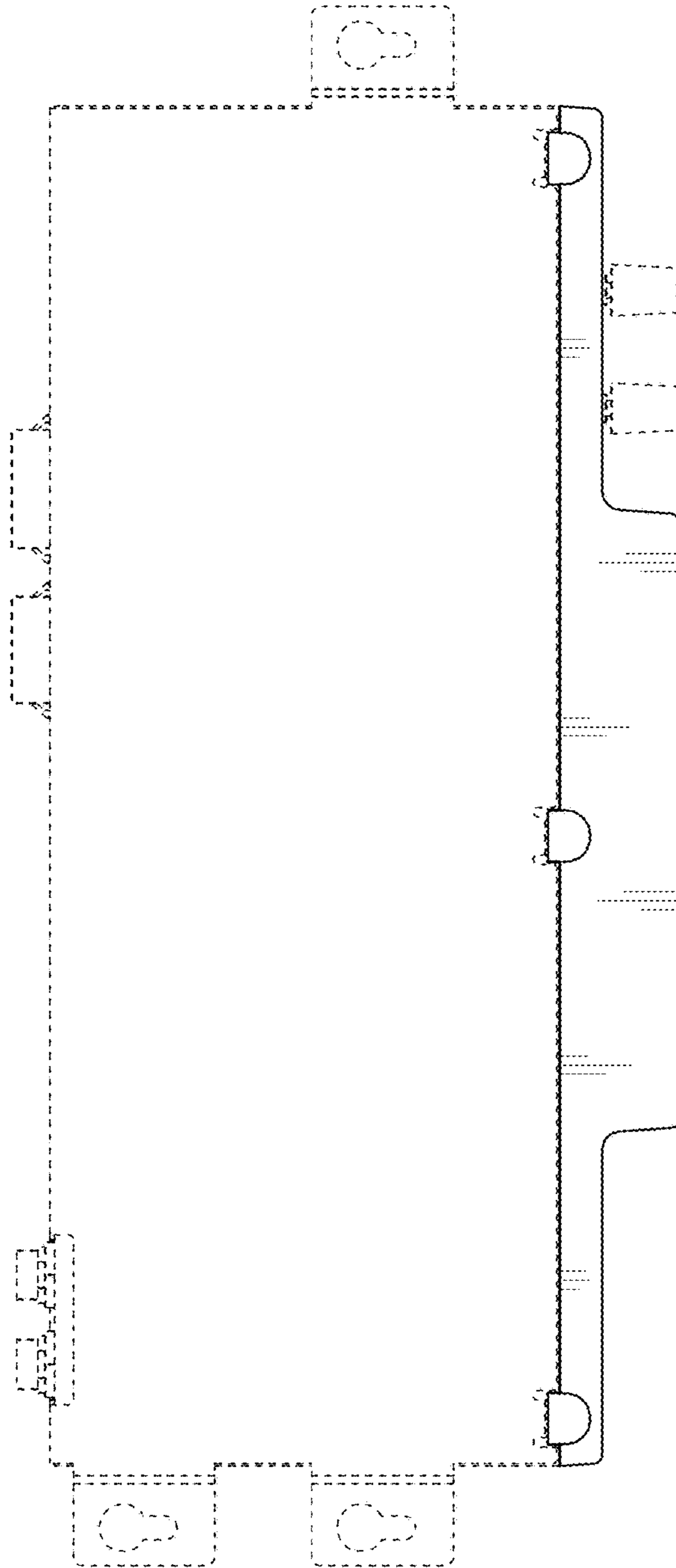

FIG. 7

