



US00D864948S

(12) **United States Design Patent**  
**Yoshida et al.**

(10) **Patent No.:** **US D864,948 S**  
(45) **Date of Patent:** **\*\* Oct. 29, 2019**

(54) **COMPUTER**

- (71) Applicant: **Fujitsu Limited**, Kawasaki (JP)
- (72) Inventors: **Tomoya Yoshida**, Kawasaki (JP);  
**Yudai Senzaki**, Tokyo (JP)
- (73) Assignee: **FUJITSU LIMITED**, Kawasaki (JP)
- (\*\*) Term: **15 Years**
- (21) Appl. No.: **35/503,908**
- (22) Filed: **May 2, 2017**

(80) **Hague Agreement Data**

- Int. Filing Date: **May 2, 2017**
- Int. Reg. No.: **DM/096728**
- Int. Reg. Date: **May 2, 2017**
- Int. Reg. Pub. Date: **Nov. 3, 2017**

(30) **Foreign Application Priority Data**

Nov. 10, 2016 (JP) ..... 2016-024489

(51) **LOC (12) Cl.** ..... **14-02**

(52) **U.S. Cl.**  
USPC ..... **D14/327**; D14/318; D14/317

(58) **Field of Classification Search**  
USPC ..... D14/315–318, 323, 327  
(Continued)

(56) **References Cited**

**U.S. PATENT DOCUMENTS**

- D494,161 S \* 8/2004 Sawauchi ..... D14/318
  - D495,691 S \* 9/2004 Takada ..... D14/318
- (Continued)

**OTHER PUBLICATIONS**

Lifebook T937 Tablet PC, posted at Fujitsu, posting date May 3, 2017. [Site visited Aug. 3, 2018] URL: <<https://web.archive.org/web/20170503030544/http://www.shopfujitsu.com:80/store/lifebook-t937-tablet-pc>> (Year: 2017).\*

(Continued)

*Primary Examiner* — George D. Kirshbaum

*Assistant Examiner* — Kathleen L Jones

(74) *Attorney, Agent, or Firm* — Oblon, McClelland,  
Maier & Neustadt, L.L.P.

(57) **CLAIM**

The ornamental design for a computer, as shown and described.

**DESCRIPTION**

1. Computer

- 1.1 : Front view, the lid open at 180 deg.
- 1.2 : Rear view, the lid open at 180 deg.
- 1.3 : Right side view
- 1.4 : Left side view
- 1.5 : Perspective view, the lid open at 180 deg.
- 1.6 : Perspective view, the lid open at 270 deg.
- 1.7 : Perspective view, the lid open at 360 deg.
- 1.8 : Perspective
- 1.9 : Top
- 1.10 : Bottom
- 1.11 : Front
- 1.12 : Rear view
- 1.13 : Right side view, the lid open at 90 deg.
- 1.14 : Perspective view, the lid open at 90 deg.
- 1.15 : Top view, the lid open at 180 deg.
- 1.16 : Bottom view, the lid open at 180 deg.
- 1.17 : Right side view, the lid open at 180 deg.
- 1.18 : Left side view, the lid open at 180 deg.
- 1.19 : Right side view, the lid open at 270 deg.
- 1.20 : Front view, the lid open at 360 deg.
- 1.21 : Rear view, the lid open at 360 deg.
- 1.22 : Top view, the lid open at 360 deg.
- 1.23 : Bottom view, the lid open at 360 deg.
- 1.24 : Right side view, the lid open at 360 deg.
- 1.25 : Left side view, the lid open at 360 deg.

The subject article is a notebook computer which can also be used as a tablet computer by rotating its lid rearward by 360 degrees. The broken lines in the drawings depict portions of the computer that form no part of the claimed design.

**1 Claim, 25 Drawing Sheets**

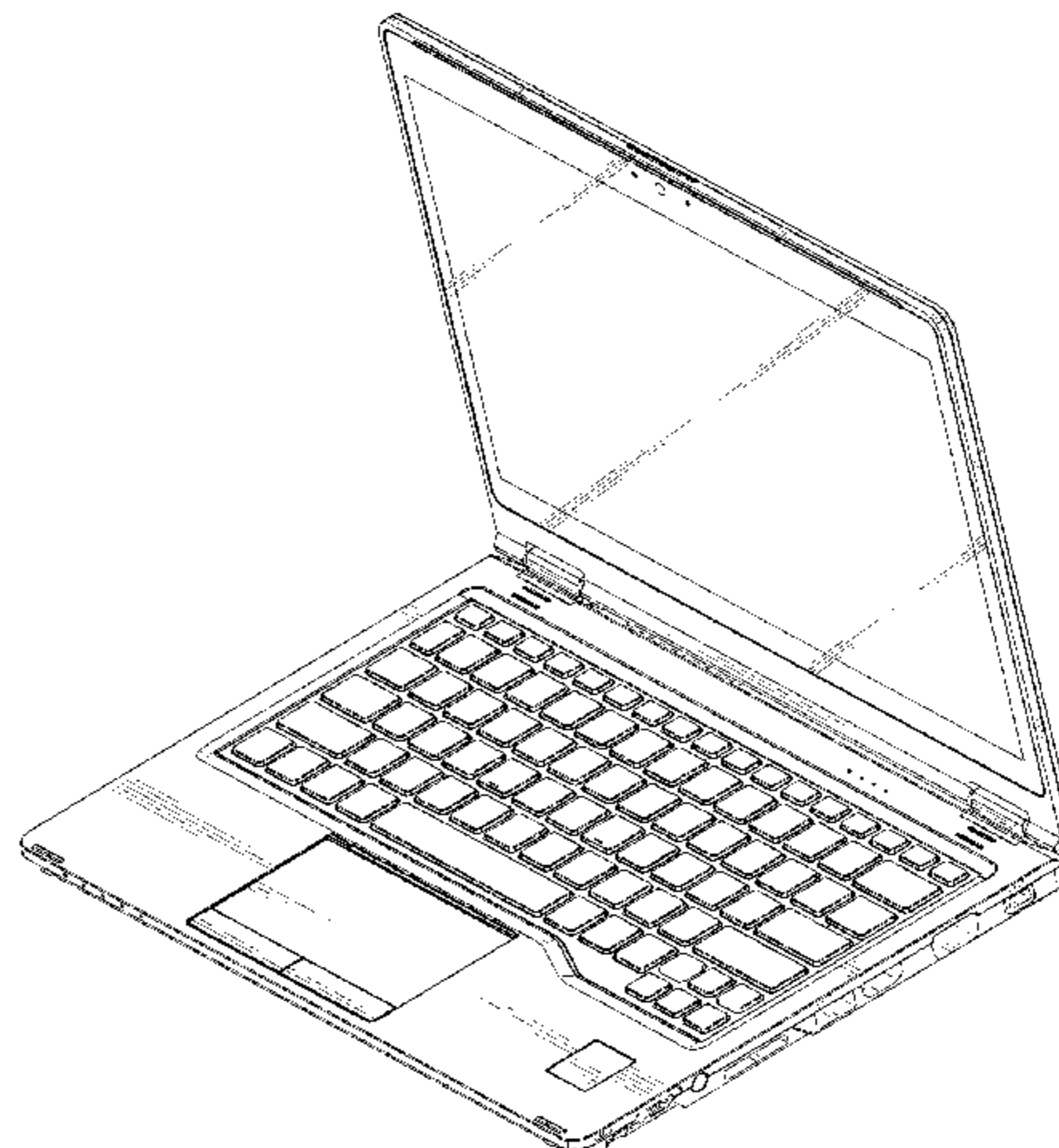
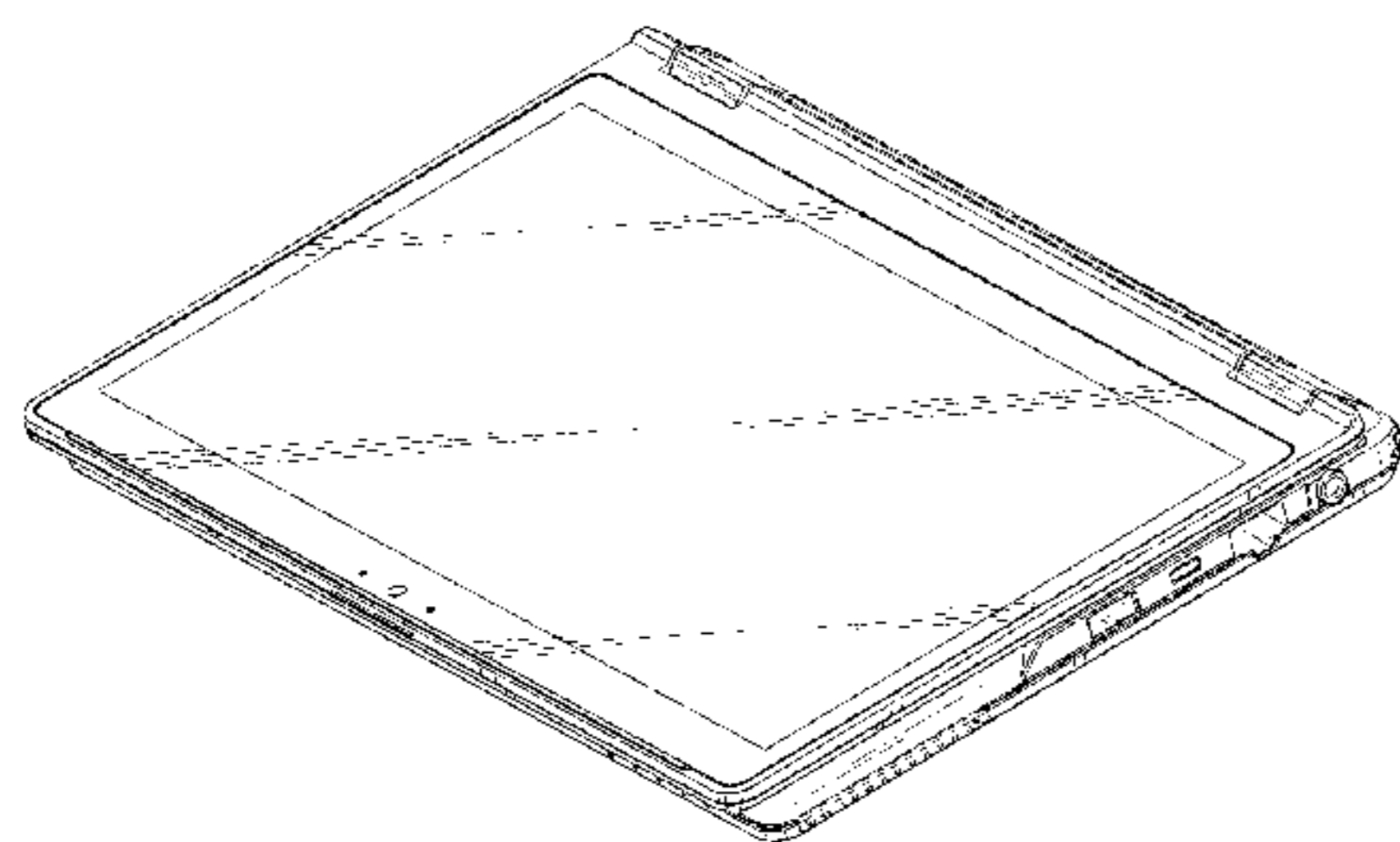

(58) **Field of Classification Search**

CPC ..... G06F 1/16; G06F 1/1616; G06F 1/1626;  
 G06F 1/1632; G06F 1/1613; G06F  
 1/1601; G06F 1/162; G06F 1/1654; G06F  
 1/1681; H01R 35/02; H03M 11/00; G09B  
 13/04; H03K 17/94; G09G 5/00; F16M  
 11/10; H05K 5/00; H04M 1/0237

See application file for complete search history.

(56) **References Cited**

U.S. PATENT DOCUMENTS

D502,177 S \* 2/2005 Takada ..... D14/318  
 D517,063 S \* 3/2006 Nakajima ..... D14/318  
 D518,042 S \* 3/2006 Kanayama ..... D14/318  
 D561,183 S \* 2/2008 Lee ..... D14/318  
 D570,344 S \* 6/2008 Isonaga ..... D14/318  
 D581,410 S \* 11/2008 Kumano ..... D14/318  
 D581,411 S \* 11/2008 Kumano ..... D14/318  
 D622,269 S \* 8/2010 Morooka ..... D14/316  
 D630,203 S \* 1/2011 Peng ..... D14/318  
 D647,897 S \* 11/2011 Kang ..... D14/327  
 D683,729 S \* 6/2013 Jen ..... D14/318  
 D697,909 S \* 1/2014 Zhao ..... D14/318  
 D700,601 S \* 3/2014 Okamoto ..... D14/318  
 D708,177 S \* 7/2014 Honda ..... D14/316  
 D715,287 S \* 10/2014 Nagao ..... D14/316  
 D715,288 S \* 10/2014 Nagao ..... D14/318  
 D723,543 S \* 3/2015 Moon ..... D14/318  
 D726,178 S \* 4/2015 Okamoto ..... D14/318  
 D727,314 S \* 4/2015 Fukuoka ..... D14/318  
 D734,323 S \* 7/2015 Takizawa ..... D14/316  
 D740,296 S \* 10/2015 Itano ..... D14/318

D750,616 S \* 3/2016 Liang ..... D14/318  
 D751,062 S \* 3/2016 Chang ..... D14/318  
 D766,233 S \* 9/2016 Lam ..... D14/315  
 D802,584 S \* 11/2017 Kong ..... D14/315  
 D803,826 S \* 11/2017 Wang ..... D14/316  
 D807,874 S \* 1/2018 Seoc ..... D14/316  
 D810,069 S \* 2/2018 Hishiki ..... D14/316  
 2004/0090742 A1 \* 5/2004 Son ..... G06F 1/1626  
 361/679.09  
 2005/0041378 A1 \* 2/2005 Hamada ..... G06F 1/1616  
 361/679.01  
 2006/0071915 A1 \* 4/2006 Rehm ..... G06F 1/1616  
 345/173  
 2009/0034173 A1 \* 2/2009 Shaum ..... G06F 1/1616  
 361/679.28  
 2017/0277228 A1 \* 9/2017 Wong ..... G06F 1/1618

OTHER PUBLICATIONS

Souppouris, Aaron, Fujitsu debuts Lifebook T902, posted at the Verge, posting date Jul. 10, 2012. [Site visited Aug. 3, 2018] URL: <<https://www.theverge.com/2012/7/10/3148611/fujitsu-lifebook-t902-stylistic-q702-release-date-price>> (Year: 2012).\*

HP Pavilion x360 offers Yoga-like flexibility for less, posted at cnet, posting date Jul. 9, 2014. [Site visited Aug. 3, 2018] URL: <<https://www.cnet.com/reviews/hp-pavilion-x360-11-inch-review/>> (Year: 2014).\*

Nuckles, Brett, Lenovo ThinkPad Yoga 12 Laptop Review, posted at Business News Daily, posting date May 8, 2015. [Site visited Aug. 8, 2018] URL: <<https://www.businessnewsdaily.com/7973-lenovo-thinkpad-yoga-12-laptop-business-review.html>> (Year: 2015).\*

\* cited by examiner



1.1

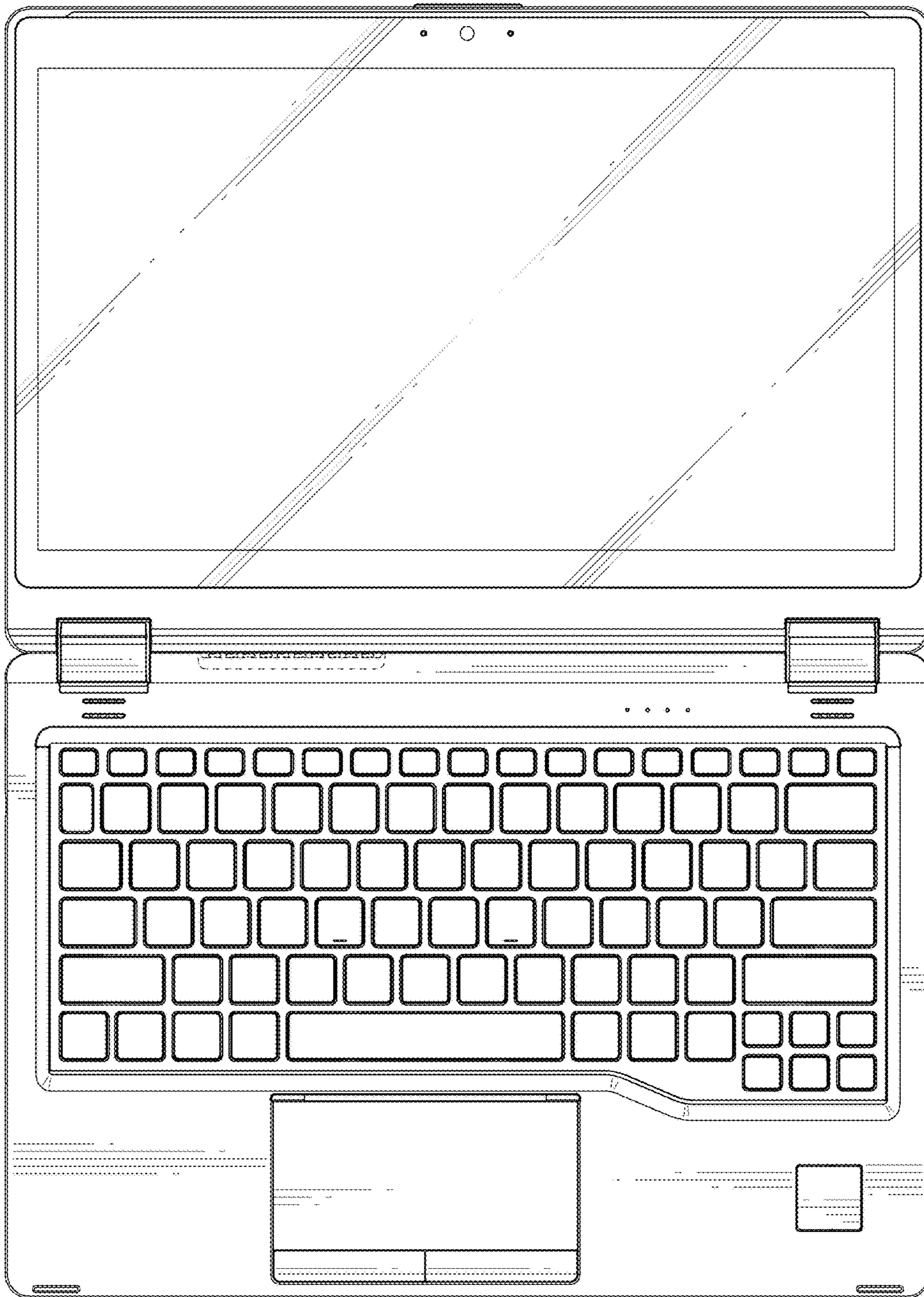

1.2

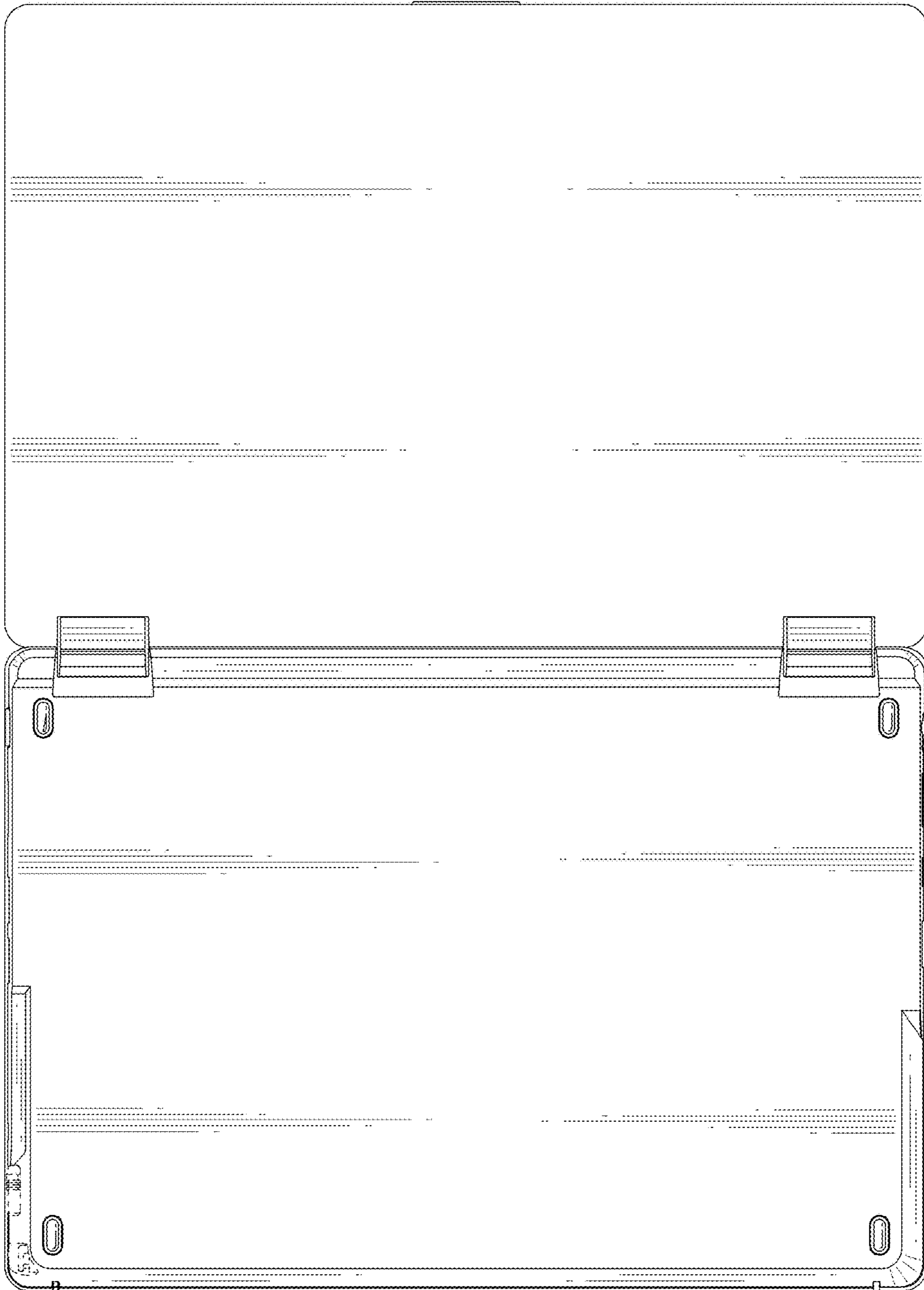

1.3

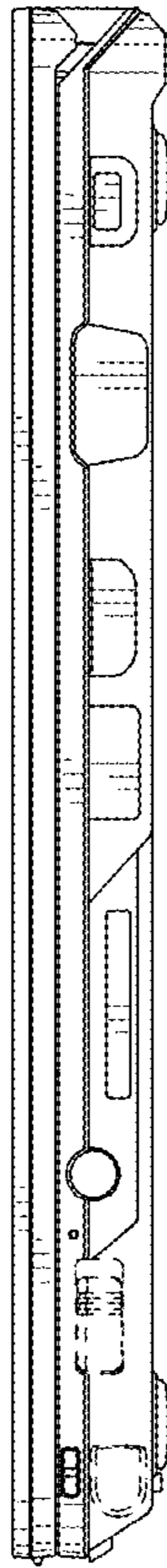

1.4

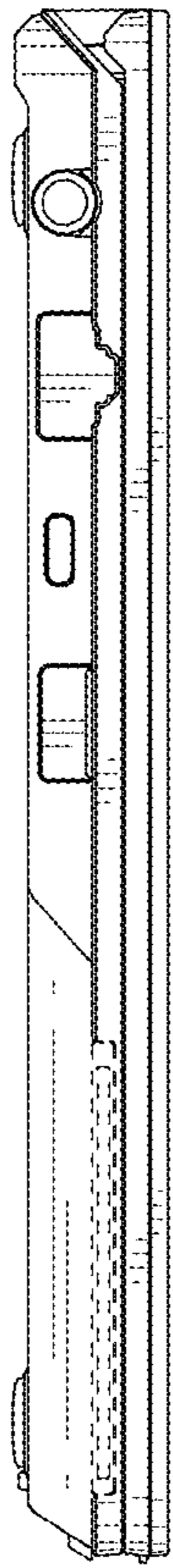

1.5

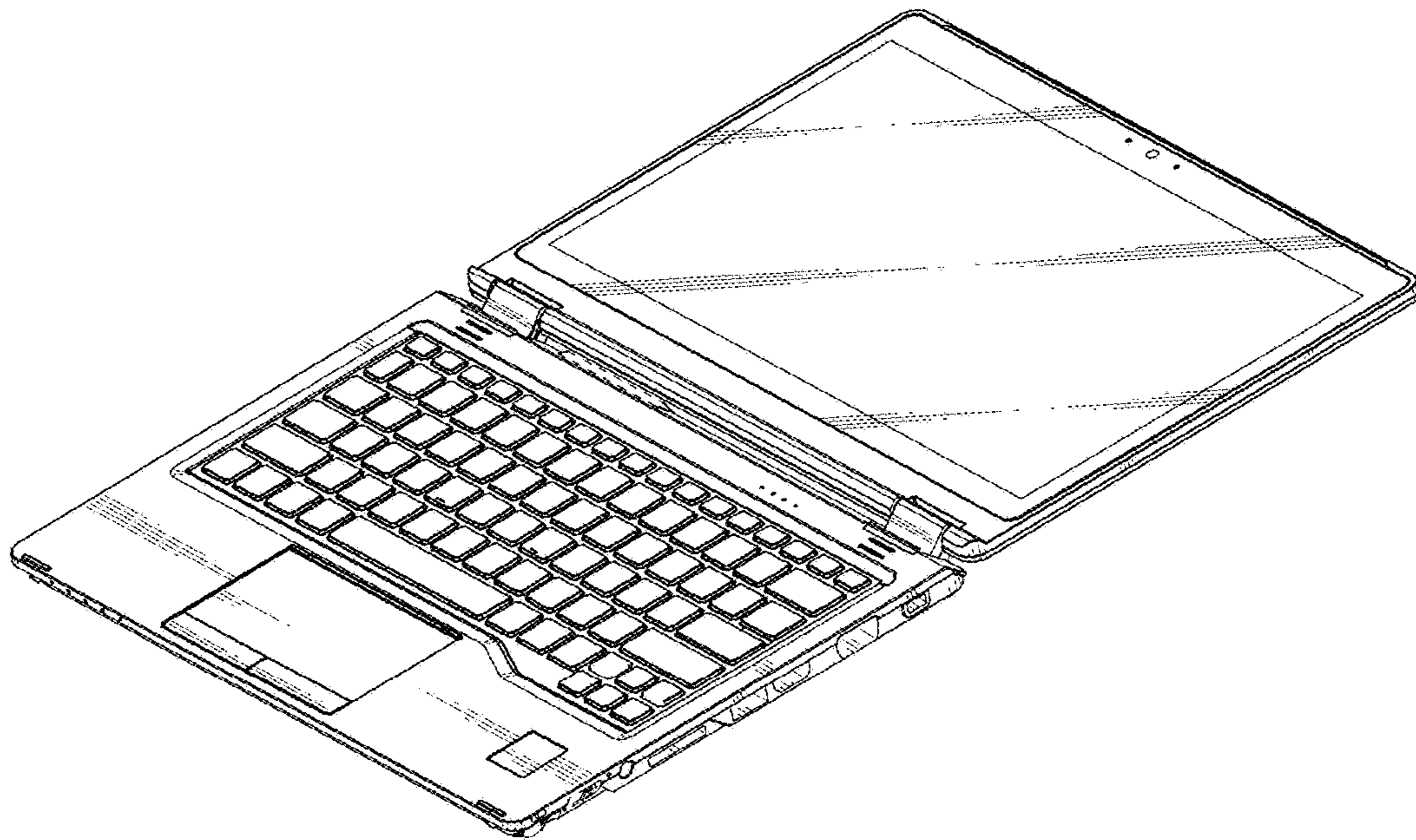



1.6

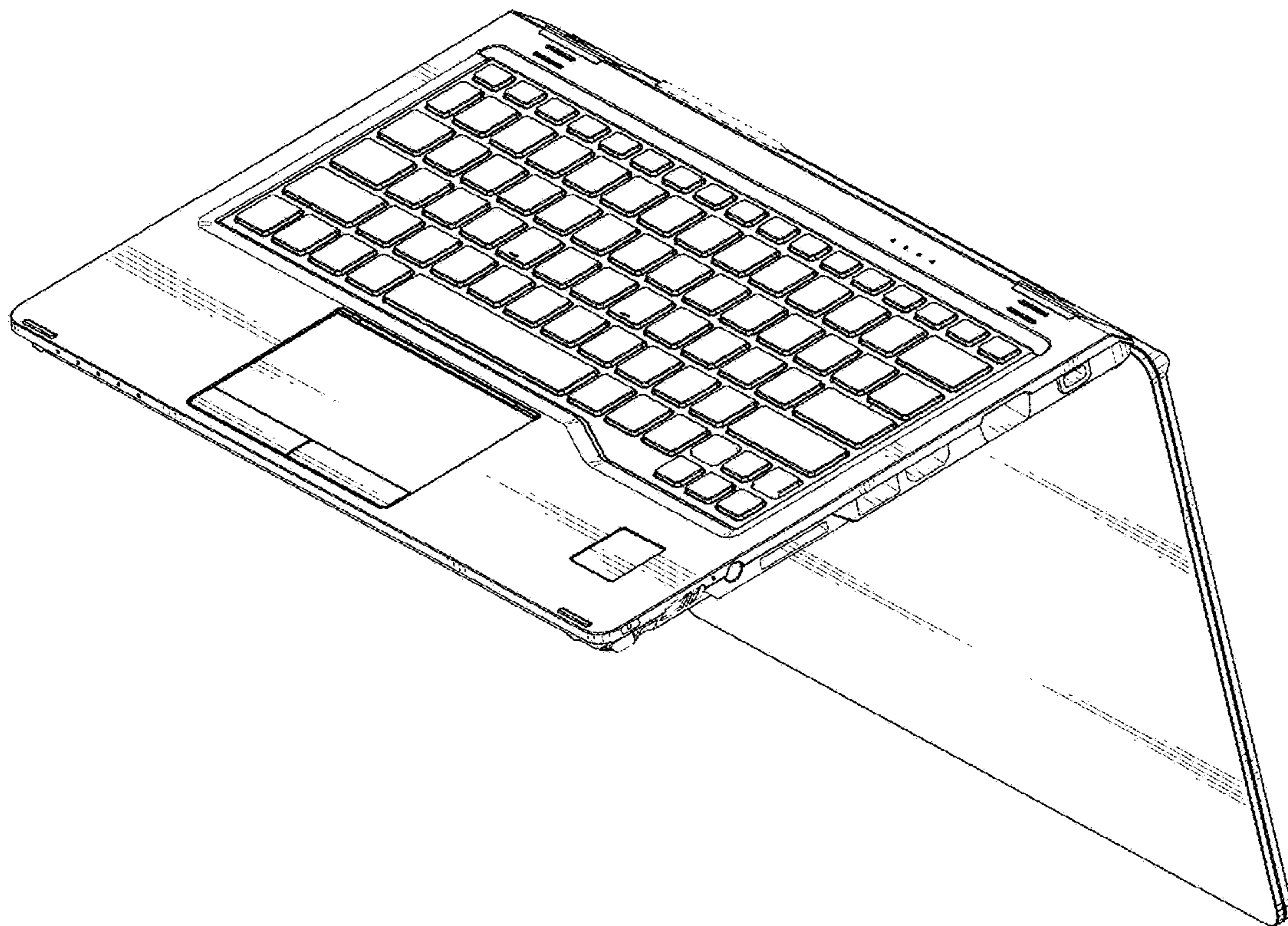



1.7

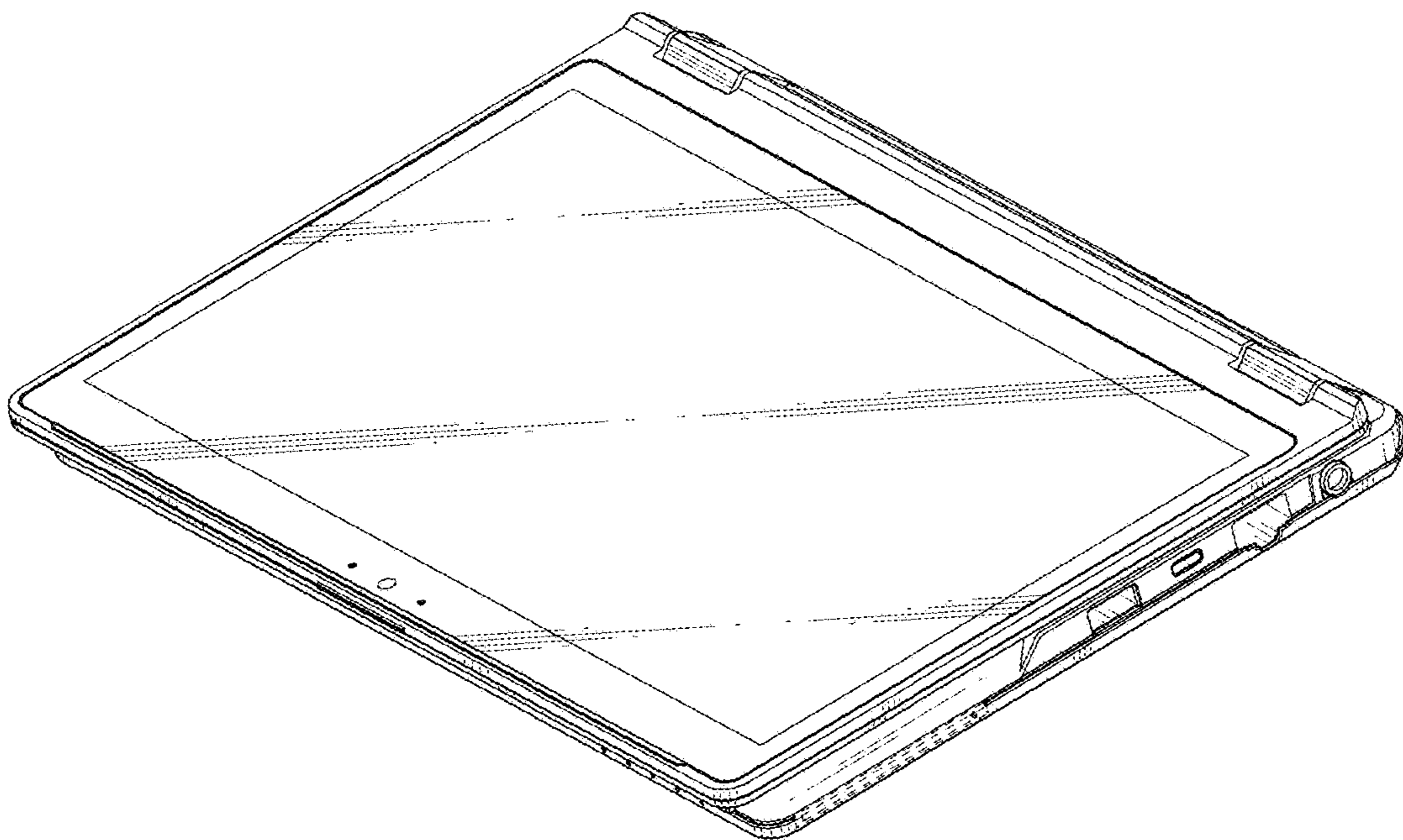

1.8

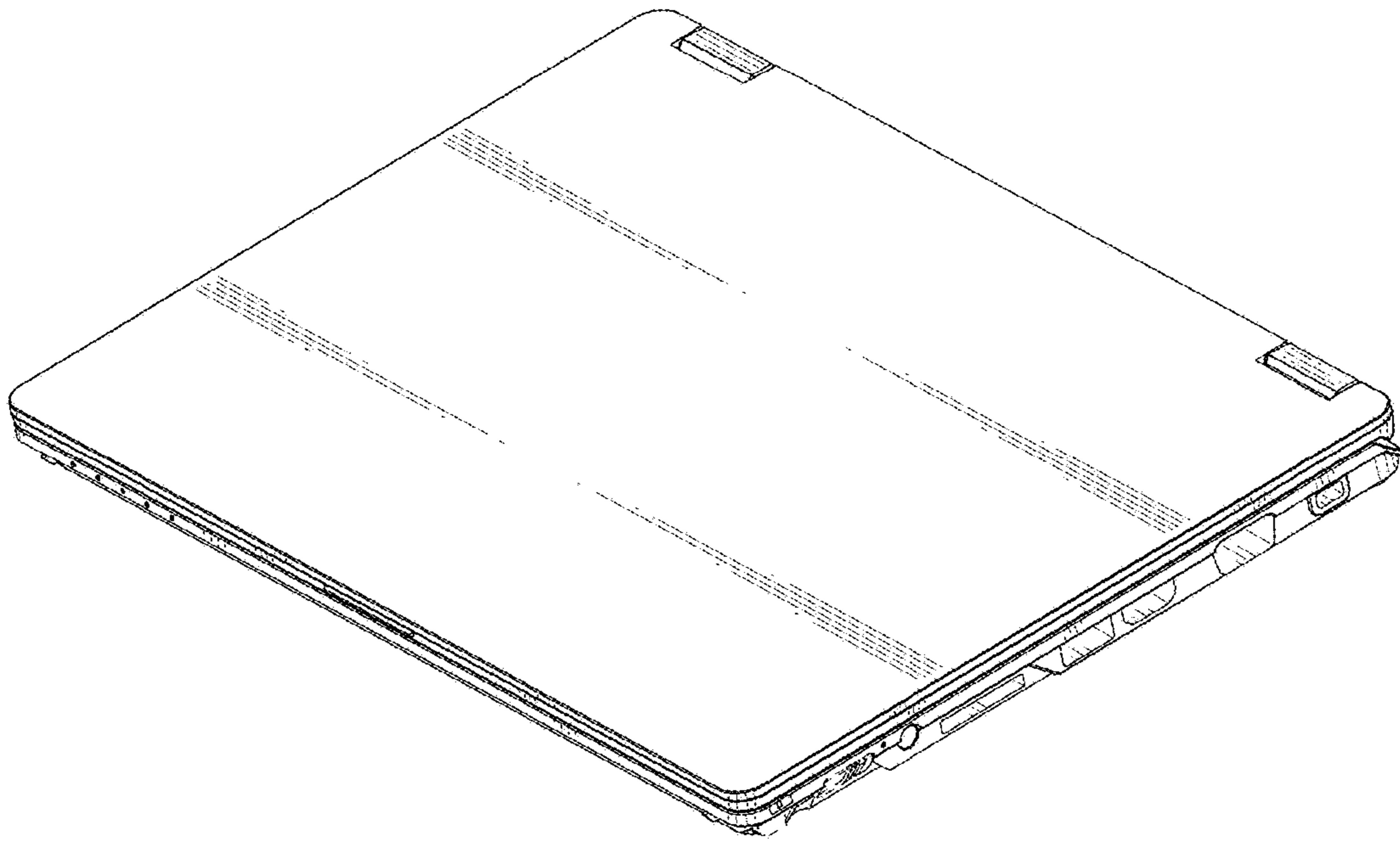

1.9

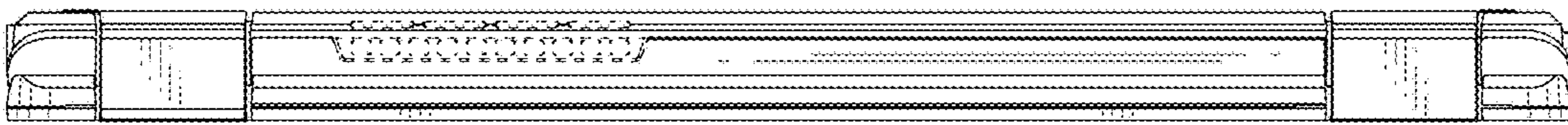

1.10





1.11

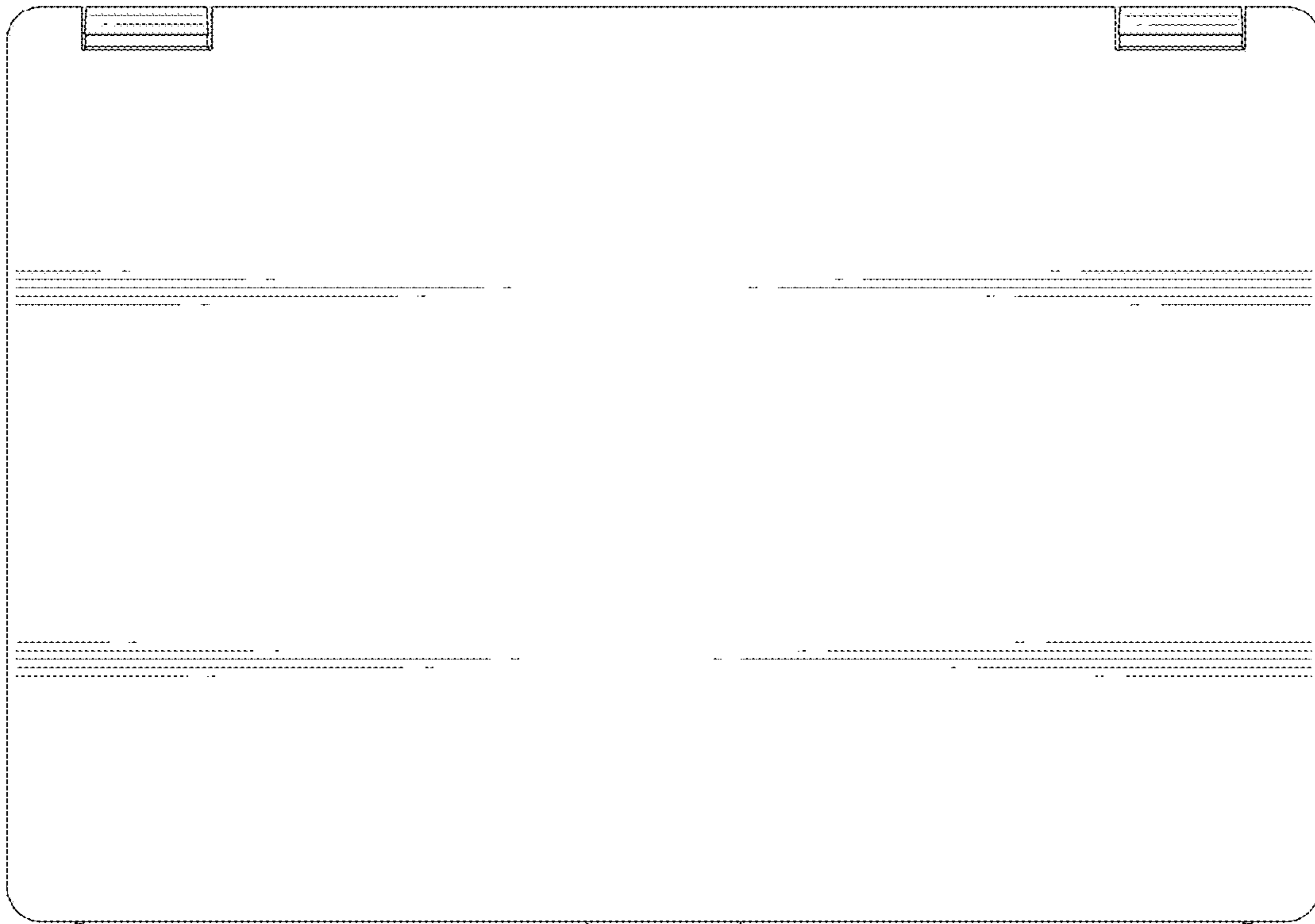

1.12



1.13

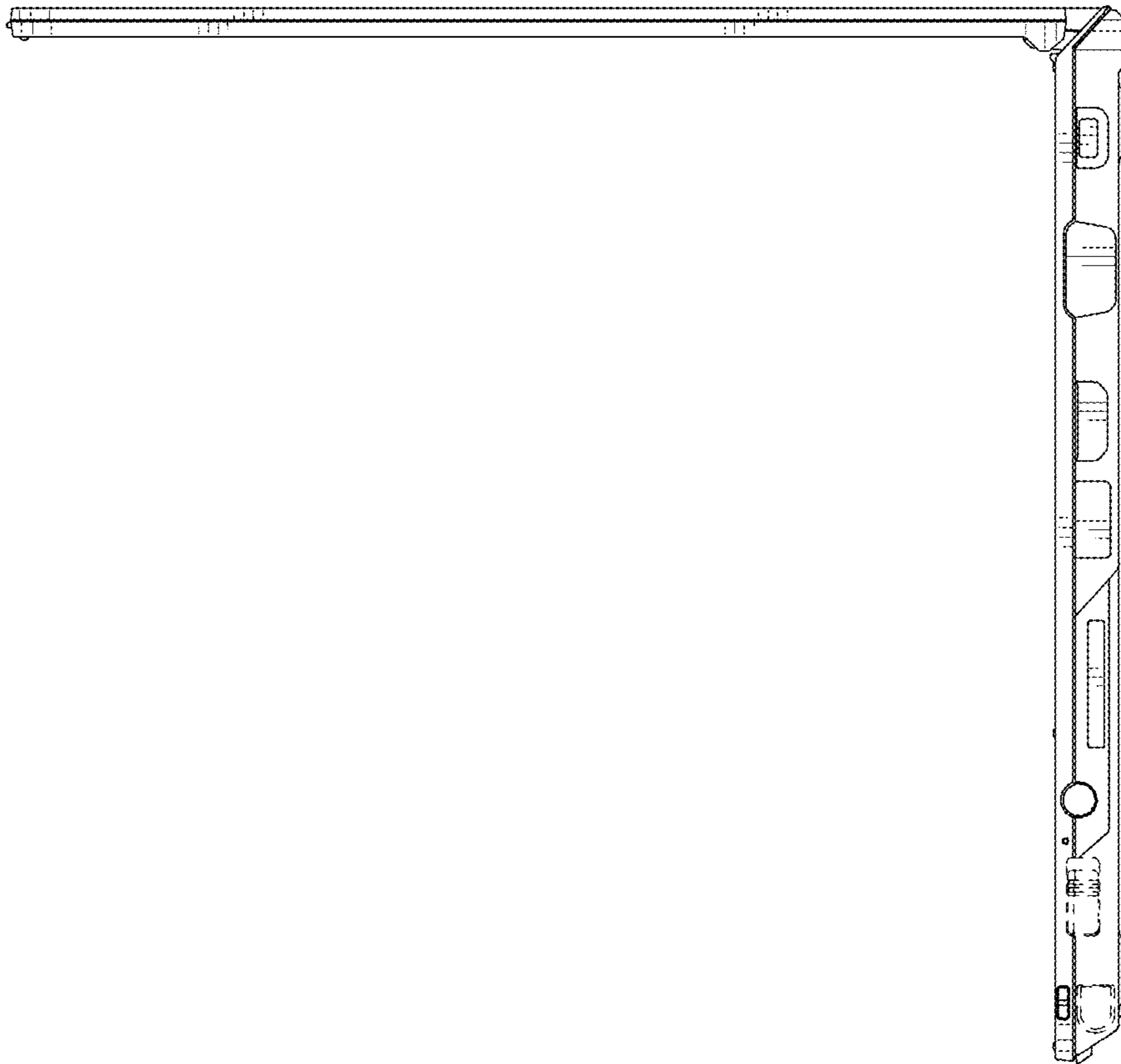

1.14

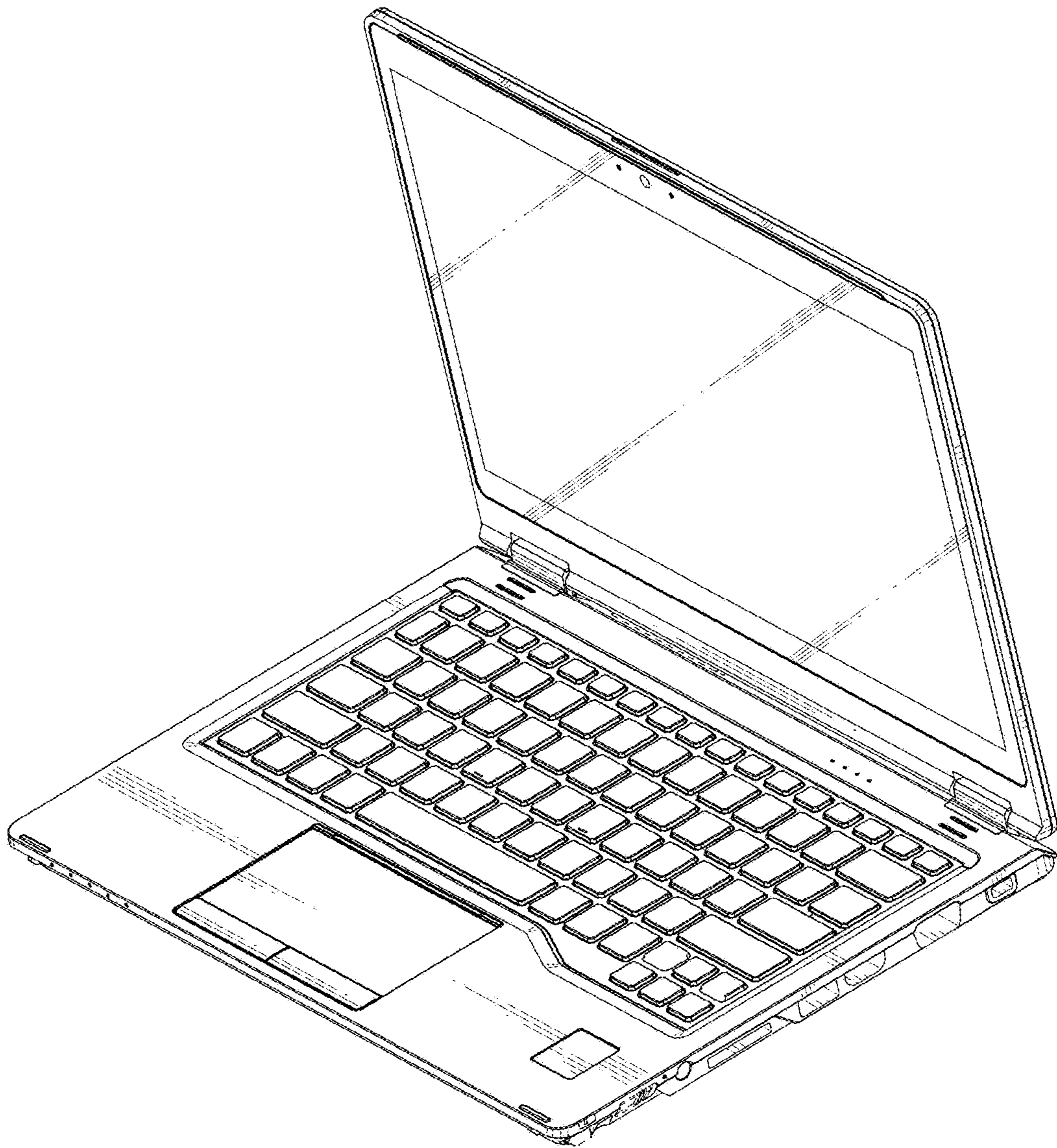



1.15

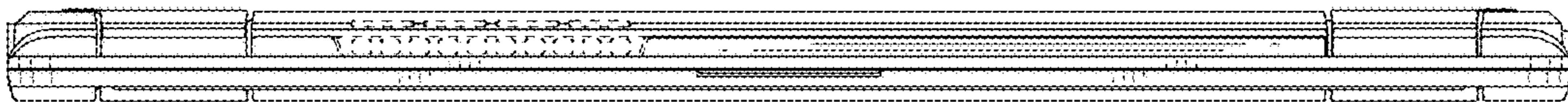

1.16

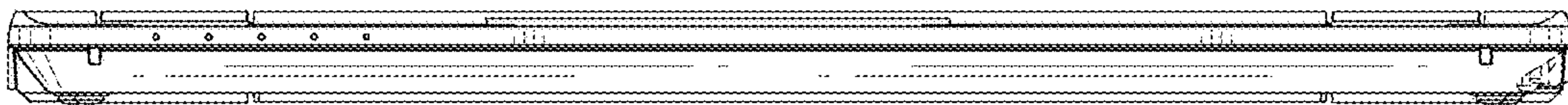

1.17

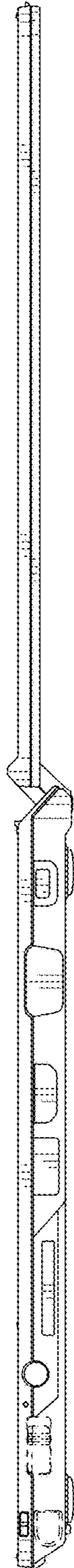

1.18





1.19

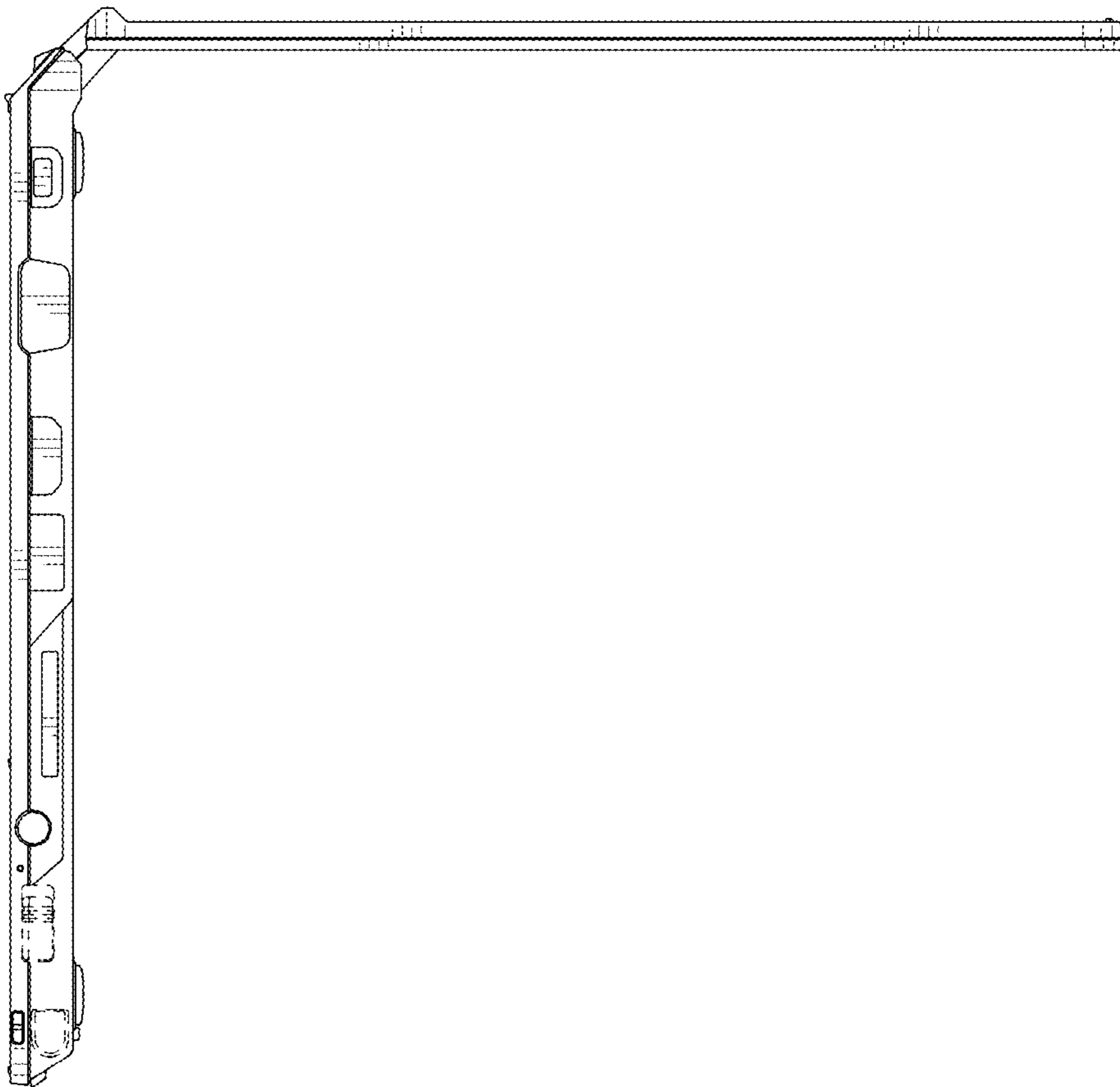

1.20

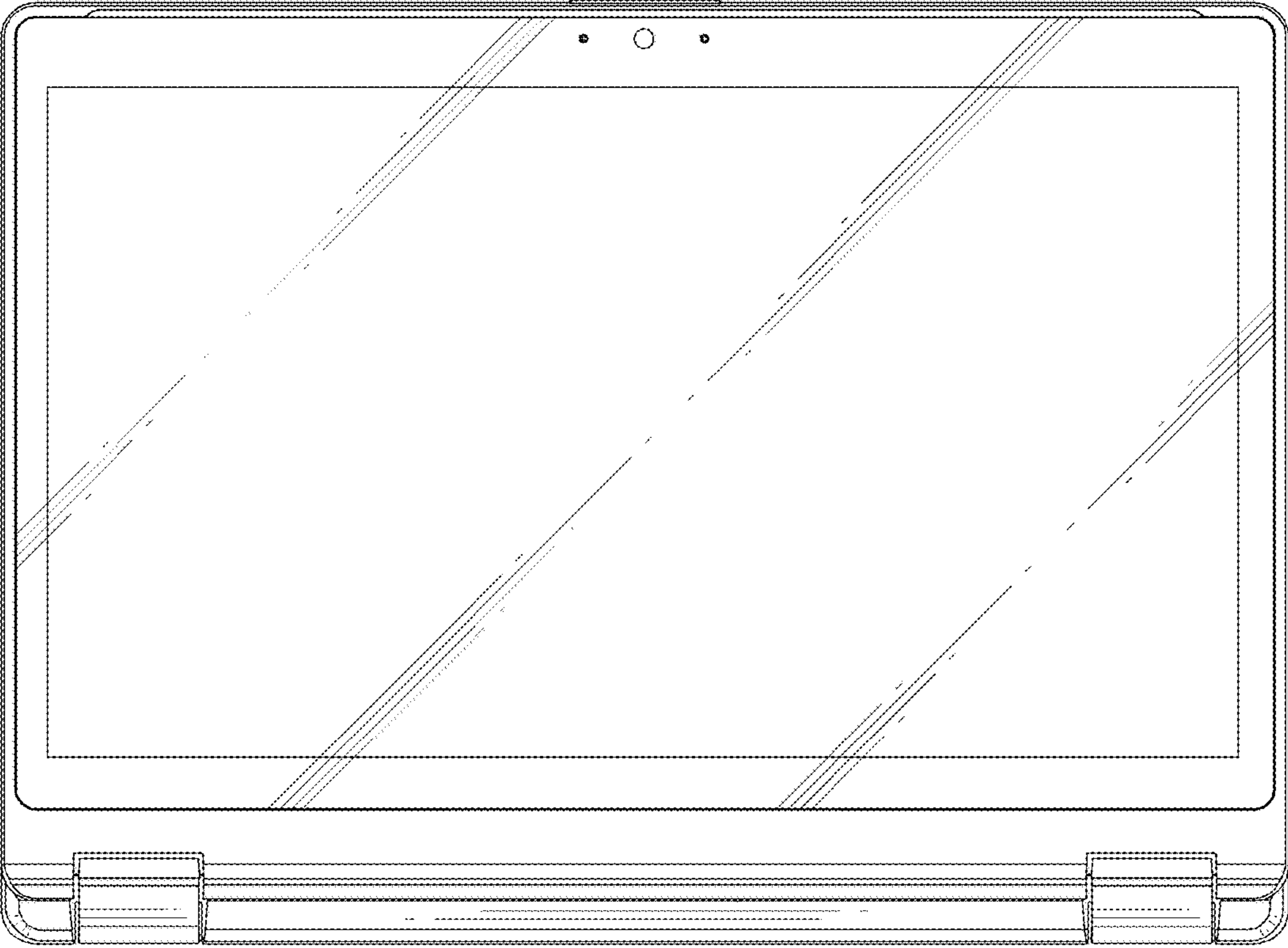

1.21

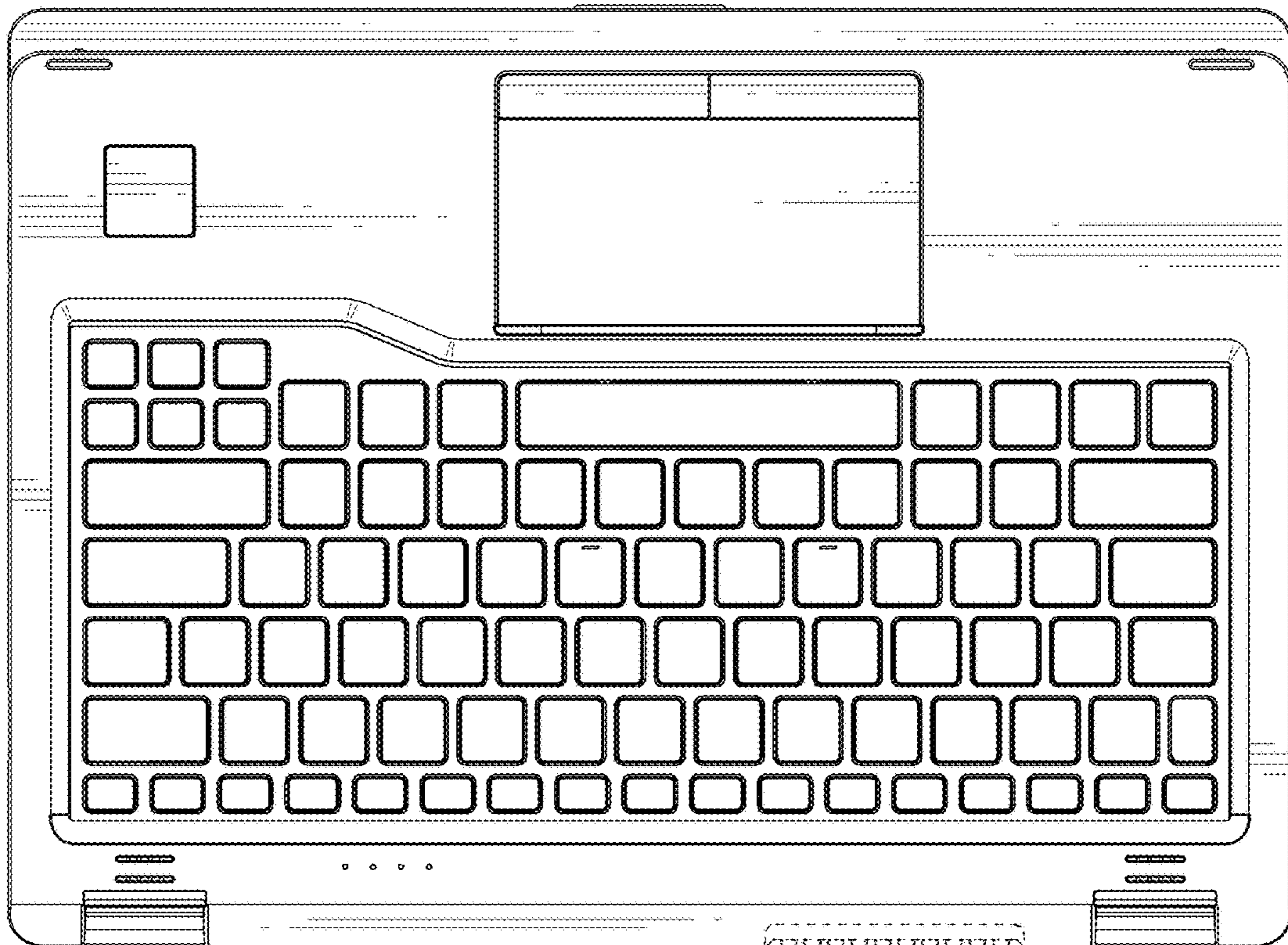

1.22

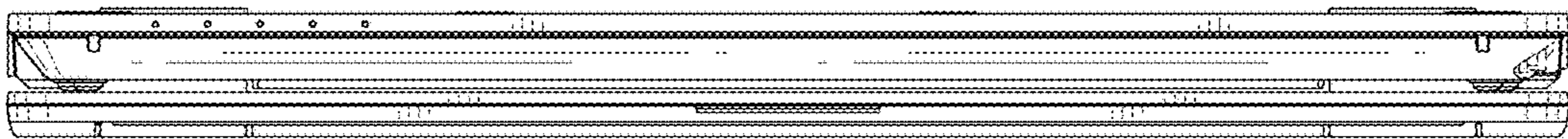

1.23

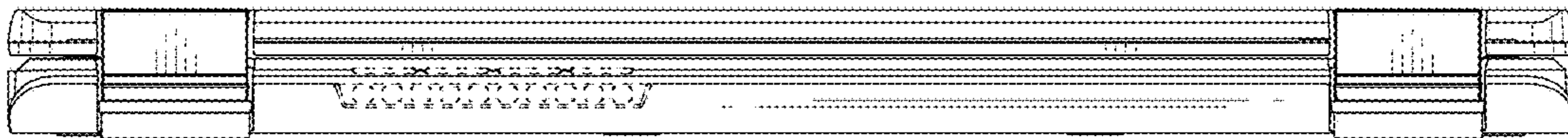

1.24

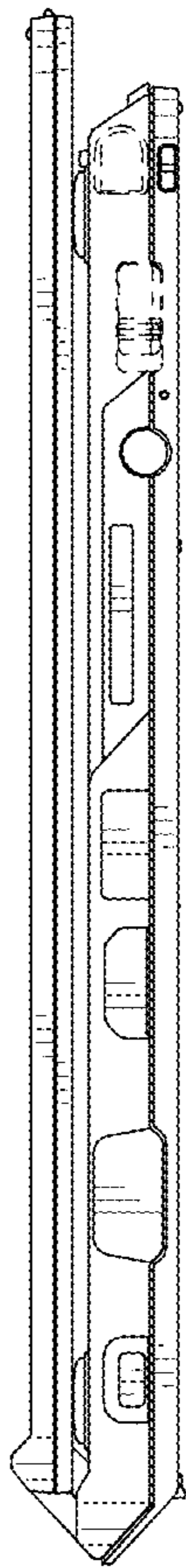



1.25

