



US00D864945S

(12) **United States Design Patent** (10) **Patent No.:** **US D864,945 S**
Lee (45) **Date of Patent:** **** *Oct. 29, 2019**

(54) **CASE FOR ELECTRONIC COMMUNICATIONS DEVICE**

amazon.com/Spigen-Armor-Galaxy-Automatic-Feature/dp/B00DCCVS5Y, Earliest review date of Mar. 18, 2013, Downloaded on Feb. 19, 2019.

(71) Applicant: **SPIGEN KOREA CO., LTD.**, Seoul (KR)

(Continued)

(72) Inventor: **Bum Joon Lee**, Seoul (KR)

Primary Examiner — Carla J Wright

(73) Assignee: **SPIGEN KOREA CO., LTD.**, Seoul (KR)

(74) *Attorney, Agent, or Firm* — Heedong Chae; Lucem, PC

(*) Notice: This patent is subject to a terminal disclaimer.

(57) **CLAIM**

The ornamental design for a case for electronic communications device, as shown and described.

(**) Term: **15 Years**

DESCRIPTION

(21) Appl. No.: **29/654,689**

FIG. 1 is a front elevational view of a case for electronic communications device showing my new design; FIG. 2 is a rear elevational view thereof; FIG. 3 is a left side elevational view thereof; FIG. 4 is a right side elevational view thereof; FIG. 5 is a top plan view thereof; FIG. 6 is a bottom plan view thereof; FIG. 7 is a front perspective view thereof; FIG. 8 is a rear perspective view thereof; FIG. 9 is a front perspective view of the inner shell component of the case shown separately for clarity of disclosure; FIG. 10 is a rear perspective view of the inner shell component of the case shown separately for clarity of disclosure; FIG. 11 is a front perspective view of the outer frame component of the case shown separately for clarity of disclosure; FIG. 12 is a rear perspective view of the outer frame component of the case shown separately for clarity of disclosure; FIG. 13 is an exploded front perspective view thereof, showing the inner shell and outer frame components separated for clarity of disclosure; and, FIG. 14 is an exploded rear perspective view thereof, showing the inner shell and outer frame components separated for clarity of disclosure.

(22) Filed: **Jun. 26, 2018**

Related U.S. Application Data

(63) Continuation of application No. 29/573,503, filed on Aug. 5, 2016, now Pat. No. Des. 824,376.

(51) **LOC (12) Cl.** **14-03**

(52) **U.S. Cl.**
USPC **D14/250**

(58) **Field of Classification Search**
USPC D14/248, 439, 203.3–203.7, 447, 238.1, D14/251–253, 217, 240, 250, 440;
(Continued)

(56) **References Cited**

U.S. PATENT DOCUMENTS

D574,819 S * 8/2008 Andre D3/269
D619,361 S * 7/2010 Andre D3/269
(Continued)

OTHER PUBLICATIONS

“Spigen Slim Armor View Galaxy S4 Case with Automatic Sleep / Wake Feature for Galaxy S4 2013—Soul Black”, <https://www.>

(Continued)

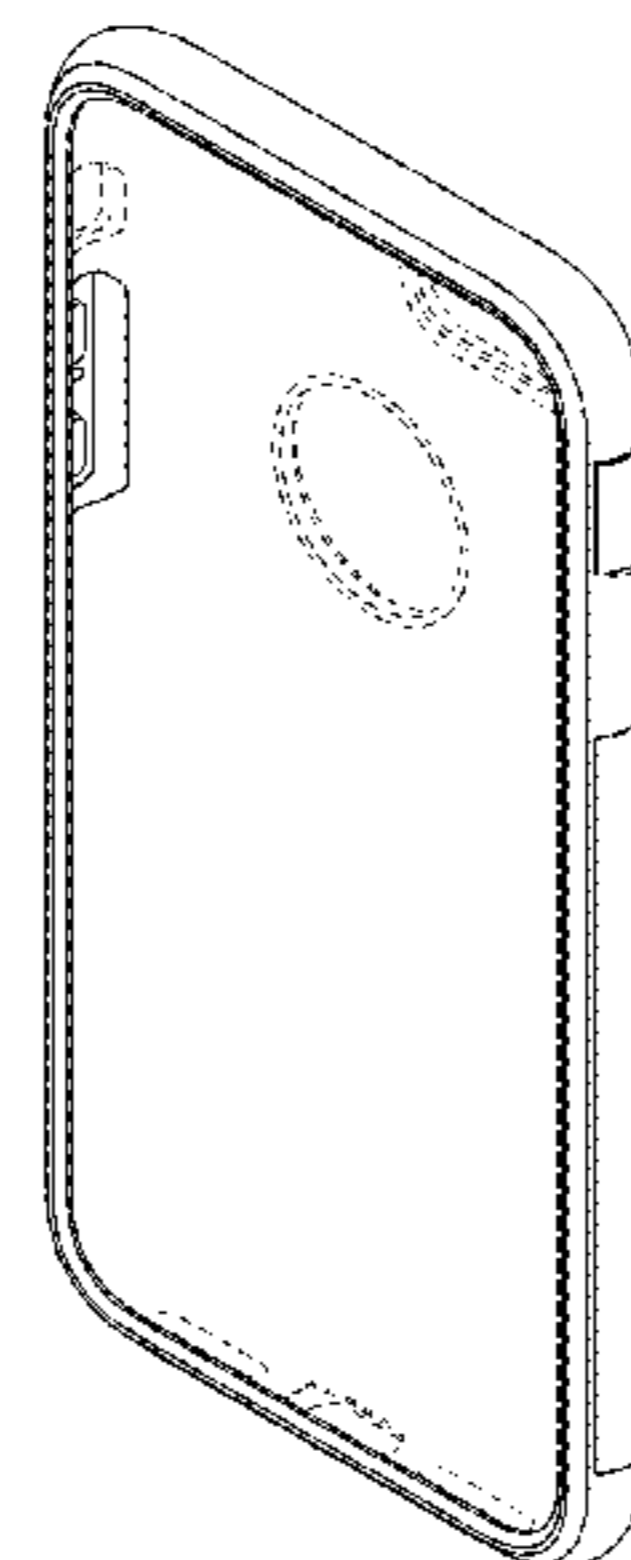
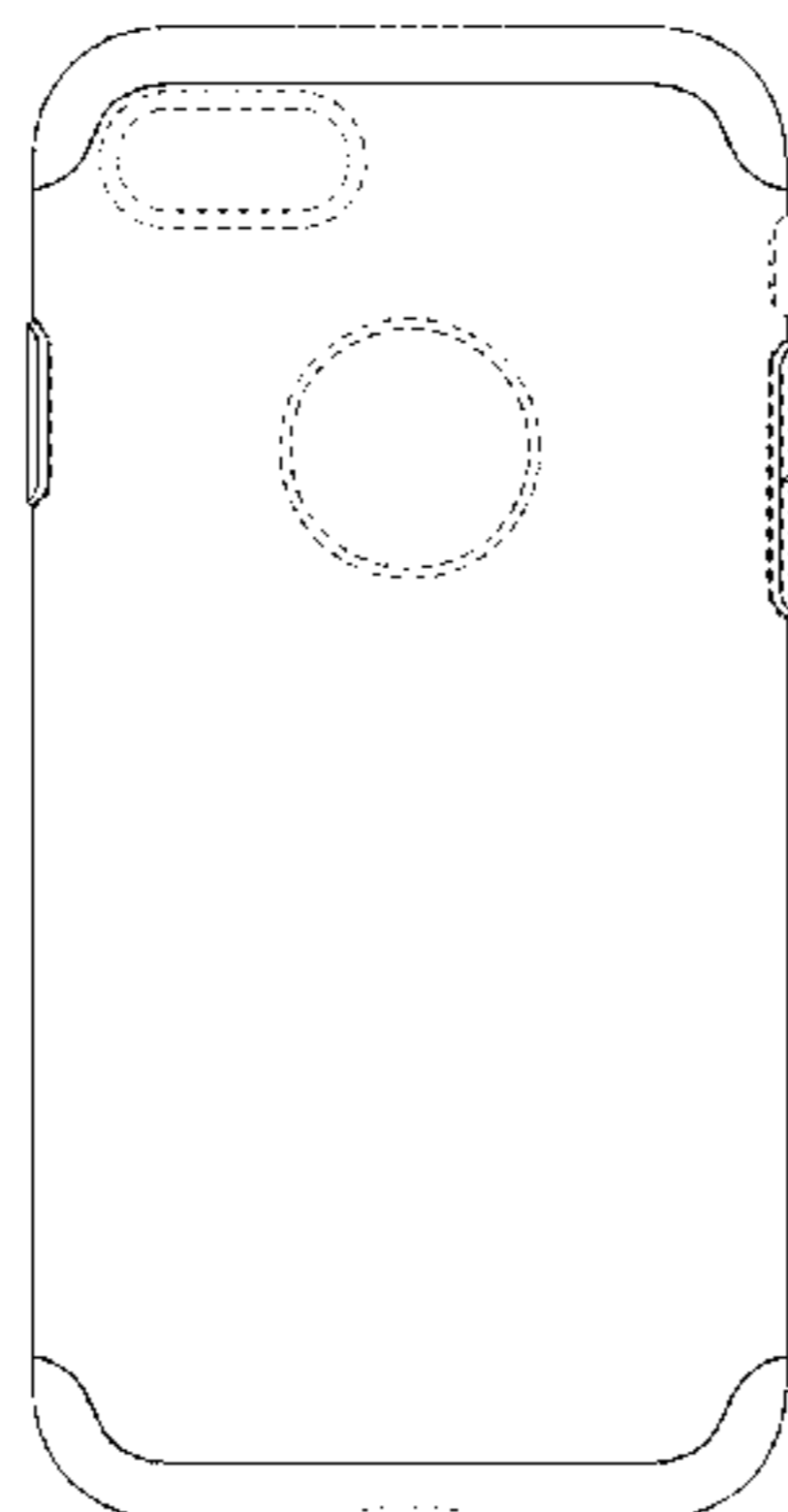

directed to the ornamental appearance of the case in its entirety and does not extend to the ornamental appearance of each of the individual components.

The broken lines throughout the drawing figures depict portions of the case that form no part of the claimed design. Except for the interior elements of the left-side button feature, which are shown in solid lines, the interior of the case shown in FIGS. 1, 7, 9, and 13 forms no part of the claimed design.

The broken lines and regions bounded by broken lines form no part of the claimed design.

1 Claim, 14 Drawing Sheets

(58) **Field of Classification Search**

USPC D3/201, 218, 247, 269, 273, 301, 303;
D13/103, 107–108, 119
CPC H04B 1/3888; H04M 1/0283; H04M
1/0202; A45C 1/06; A45C 11/00; A45C
13/02; A45C 2011/002; A45F 2005/026;
A45F 2200/0525; A45F 2200/0516

See application file for complete search history.

(56) **References Cited**

U.S. PATENT DOCUMENTS

D622,716 S *	8/2010	Andre	D14/250
D625,303 S	10/2010	Kim		
D626,121 S	10/2010	Richardson		
D637,589 S	5/2011	Willes		
D657,782 S	4/2012	Biller		
D673,554 S *	1/2013	Simmer	D14/250
D675,198 S *	1/2013	Andre	D14/250
D676,845 S	2/2013	Melanson		
D677,251 S	3/2013	Melanson		
8,439,191 B1	5/2013	Lu		
8,517,172 B1	8/2013	Chang		
D689,852 S	9/2013	Azoulay		
D696,239 S *	12/2013	Murchison	D14/250
D703,652 S	4/2014	Melanson		
D703,655 S	4/2014	Melanson		
D712,386 S	9/2014	Lu		
D712,892 S *	9/2014	Hong	D14/250
D714,274 S	9/2014	Jung		
D714,276 S	9/2014	Hu		
D718,291 S *	11/2014	Hong	D14/250
D721,067 S	1/2015	Su		
D721,360 S *	1/2015	Laffon de Mazieres	D14/250
9,004,275 B2	4/2015	Lee		
9,071,674 B2	6/2015	Yow		
D736,205 S	8/2015	Park		
9,143,181 B1	9/2015	Jia		
D741,279 S	10/2015	Tai		
D741,845 S	10/2015	Kim		
D743,389 S *	11/2015	Akana	D14/250
D746,275 S *	12/2015	Mohammad	D14/250
D748,614 S	2/2016	Ju		
9,281,858 B2	3/2016	Fathollahi		
9,295,174 B2	3/2016	Witter et al.		
D753,099 S	4/2016	Kim		
D753,641 S	4/2016	Roberts et al.		
D754,652 S	4/2016	Roberts et al.		
D756,340 S	5/2016	Babichenko		
D756,343 S *	5/2016	Wall	D14/250
D757,702 S	5/2016	Kanazawa		
D757,703 S	5/2016	Kanazawa		
D761,239 S	7/2016	Kim		
D763,841 S *	8/2016	Kim	D14/250
D763,842 S	8/2016	Chang et al.		
D765,632 S	9/2016	Northrup et al.		

D765,642 S	9/2016	Bulkley		
D765,644 S	9/2016	Witter et al.		
D767,485 S	9/2016	To et al.		
9,467,189 B2	10/2016	Day et al.		
D771,028 S	11/2016	Kim		
D771,607 S	11/2016	Kim		
D771,608 S	11/2016	Kim		
D772,209 S	11/2016	Kim		
D772,210 S *	11/2016	Igarashi	D14/250
D772,854 S *	11/2016	Igarashi	D14/250
D775,619 S	1/2017	Tien		
D775,620 S	1/2017	Kim		
D776,104 S	1/2017	Tien		
D776,649 S	1/2017	Kim		
D777,155 S	1/2017	Kim		
D777,156 S	1/2017	Kim		
D777,717 S	1/2017	Kim		
D823,291 S *	7/2018	Akana	D14/250
D824,376 S *	7/2018	Lee	D14/250
D824,377 S *	7/2018	Kim	D14/250
D827,627 S *	9/2018	Lee	D14/250
2009/0283184 A1	11/2009	Han		
2016/0049979 A1	2/2016	Grouwstra		
2017/0035172 A1	2/2017	Kim		
2018/0262227 A1 *	9/2018	Lee	H04B 1/3888

OTHER PUBLICATIONS

“Spigen Slim Armor Nexus 5 Case with Air Cushion Technology and Hybrid Drop Protection for Nexus 5 2013—Infinity White”, <https://www.amazon.com/Spigen-Cushion-Technology-Hybrid-Protection/dp/B00EV8Y7XI>, Earliest review date of Nov. 4, 2013, Downloaded on Jan. 16, 2019.

“Spigen Slim Armor View Galaxy S5 Case with Automatic Sleep / Wake Feature for Samsung Galaxy S5 2014—View Smooth White”, <https://www.amazon.com/Spigen-Galaxy-Automatic-Feature-Samsung/dp/B00KGG02EI>, Earliest review date of Jan. 18, 2014, Downloaded on Jan. 16, 2019.

“Spigen Tough Armor Galaxy S5 Case with Extreme Heavy Duty Protection and Air Cushion Technology for Samsung Galaxy S5 2014—Gunmetal”, <https://www.amazon.com/Spigen-Extreme-Protection-Cushion-Technology/dp/B00I3UWDV8>, Earliest review date of Mar. 9, 2014, Downloaded on Aug. 9, 2018.

“Spigen Slim Armor Galaxy S5 Case with Air Cushion Technology and Hybrid Drop Protection for Samsung Galaxy S5 2014—Metal Slate”, <https://www.amazon.com/dp/B00I3UWD7C>, Earliest review date of Apr. 11, 2014, Downloaded on Sep. 18, 2018.

“Spigen Slim Armor LG G3 Case with Air Cushion Technology and Hybrid Drop Protection for LG G3 2014—Metal Slate”, <https://www.amazon.com/Spigen-Cushion-Technology-Hybrid-Protection/dp/B00JQI2G5O>, Earliest review date of Jul. 9, 2014, Downloaded on Jan. 16, 2019.

“Spigen Tough Armor Galaxy S6 Edge Case with Reinforced Kickstand and Heavy Duty Protection and Air Cushion Technology for Samsung Galaxy S6 Edge (2015)—Gunmetal”, <https://www.amazon.com/Spigen-Reinforced-Kickstand-Protection-Technology/dp/B00SV63L38>, Earliest review date of Mar. 12, 2015, Downloaded on Aug. 9, 2018.

“Spigen Slim Armor Galaxy S6 Case with Air Cushion Technology and Kickstand for Samsung Galaxy S6 2015—Shimmery White”, <https://www.amazon.com/dp/B00QU4NQMY>, Earliest review date of Mar. 21, 2015, Downloaded on Sep. 18, 2018.

“Spigen Tough Armor Galaxy S6 Case with Reinforced Kickstand and Heavy Duty Protection and Air Cushion Technology for Samsung Galaxy S6 (2015)—Gunmetal”, <https://www.amazon.com/Spigen-Reinforced-Kickstand-Protection-Technology/dp/B00QU4PUKK>, Earliest review date of Mar. 23, 2015, Downloaded on Aug. 9, 2018.

“Spigen Slim Armor Galaxy S6 Edge Case with Kickstand and Hybrid Drop Protection for Galaxy S6 Edge 2015—Gunmetal”, <https://www.amazon.com/dp/B00SV638ZE>, Earliest review date of Apr. 3, 2015, Downloaded on Sep. 18, 2018.

* cited by examiner

FIG. 1

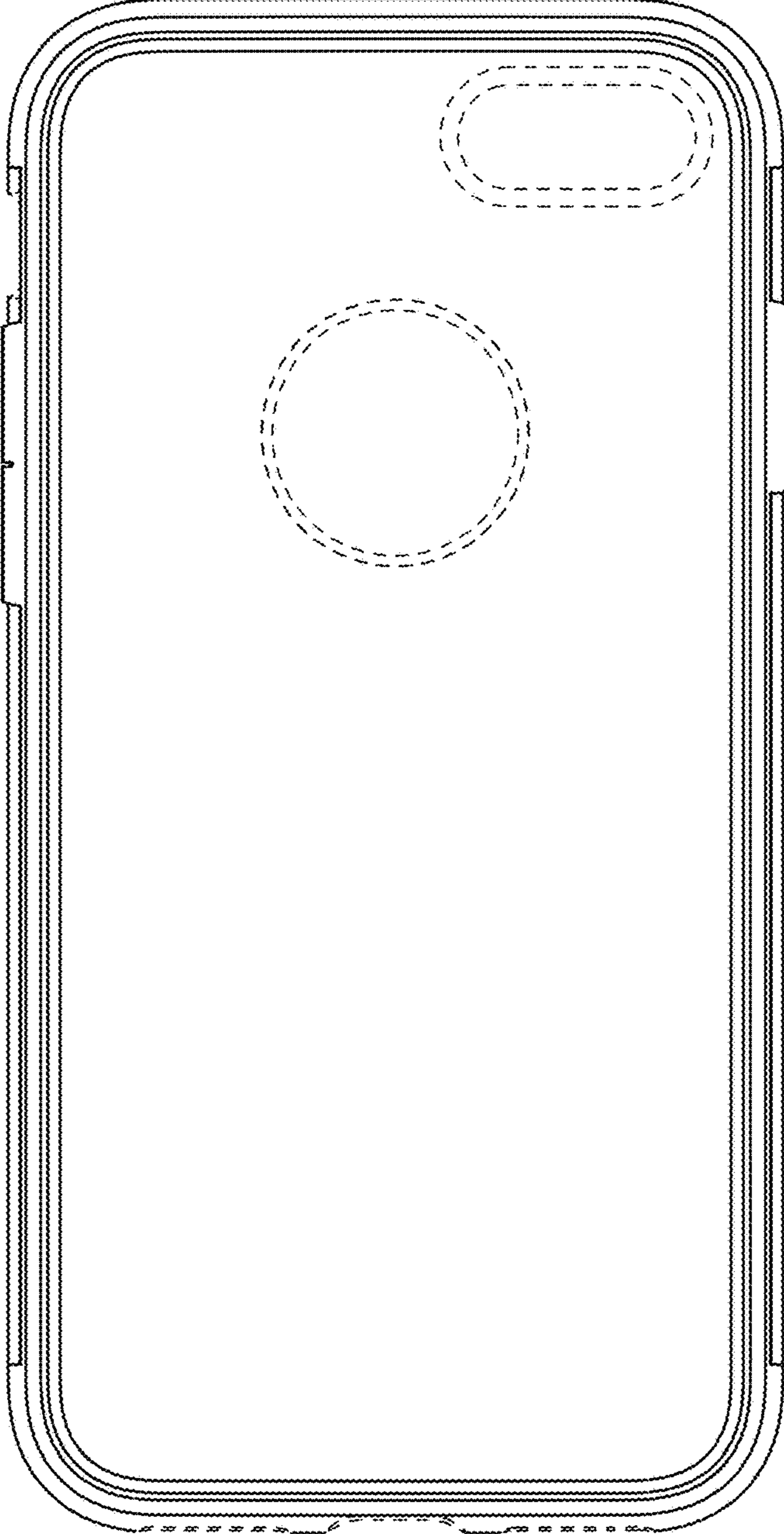

FIG. 2

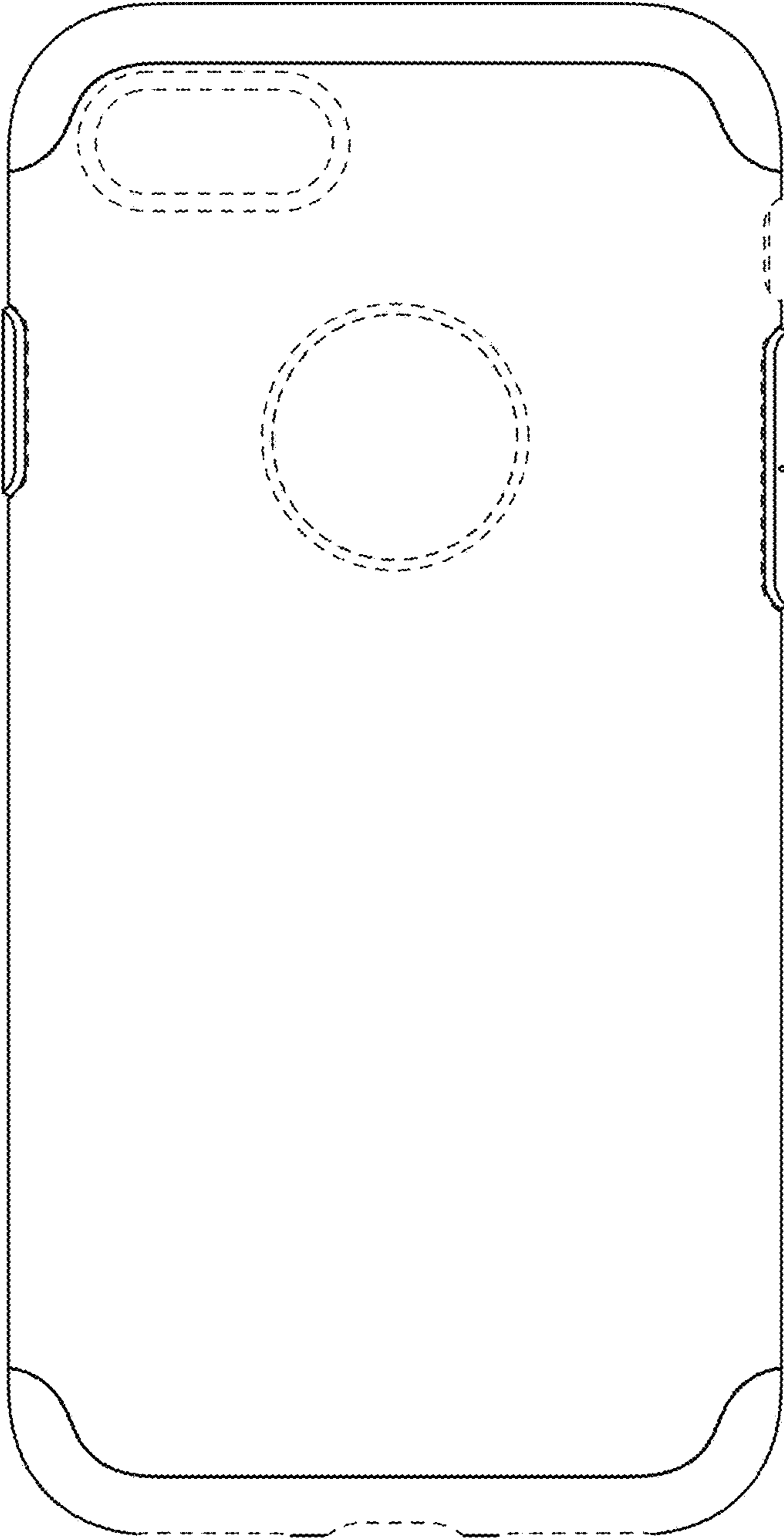

FIG. 3

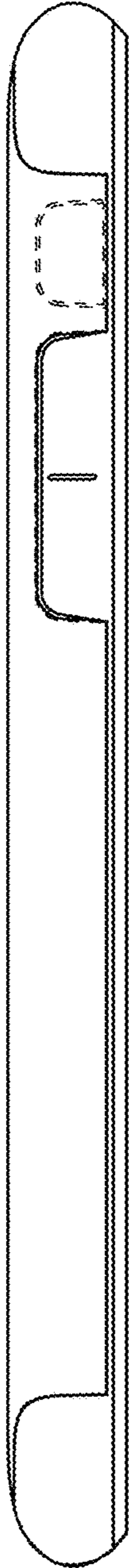

FIG. 4

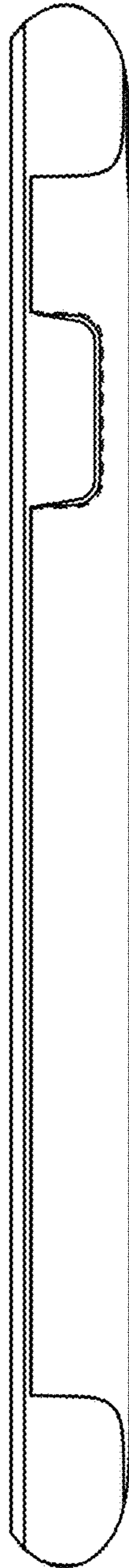

FIG. 5



FIG. 6

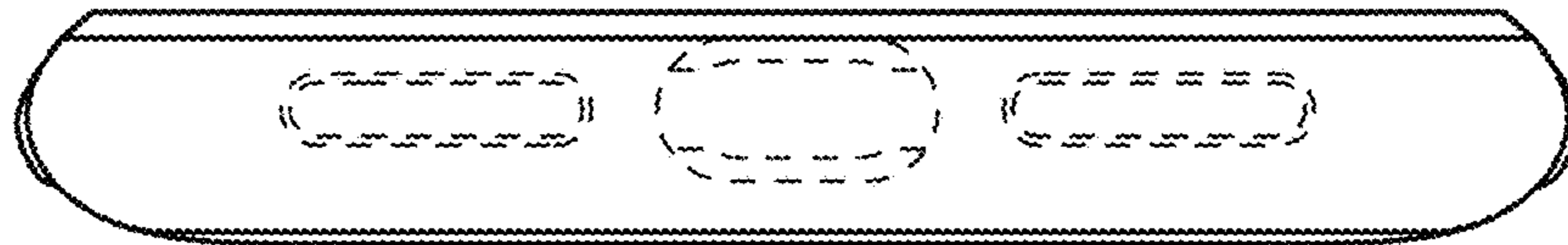

FIG. 7

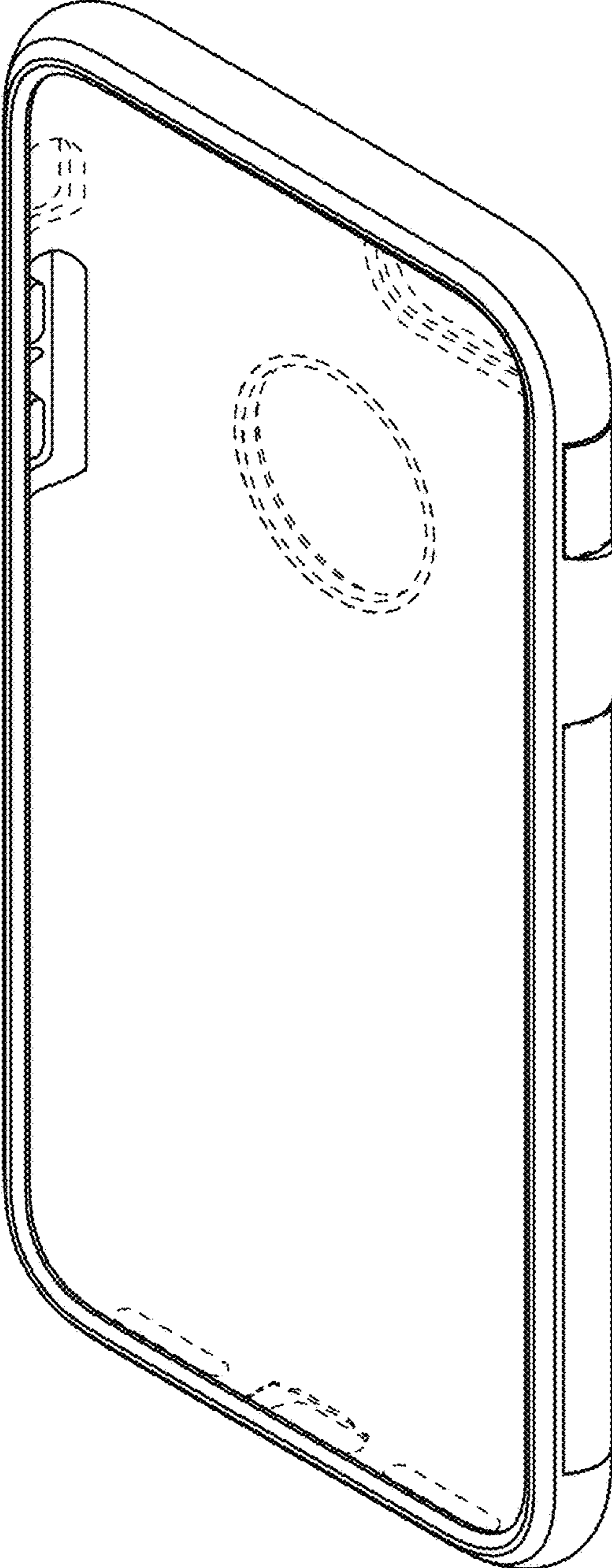

FIG. 8

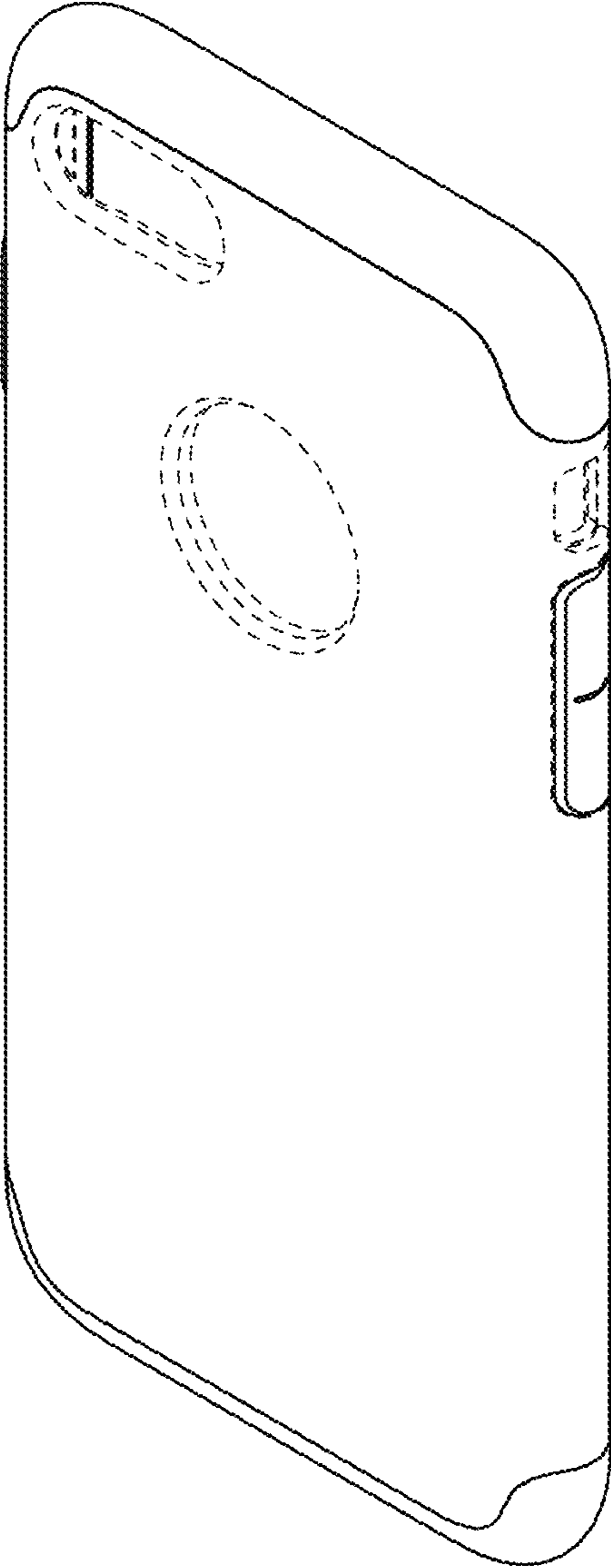

FIG. 9

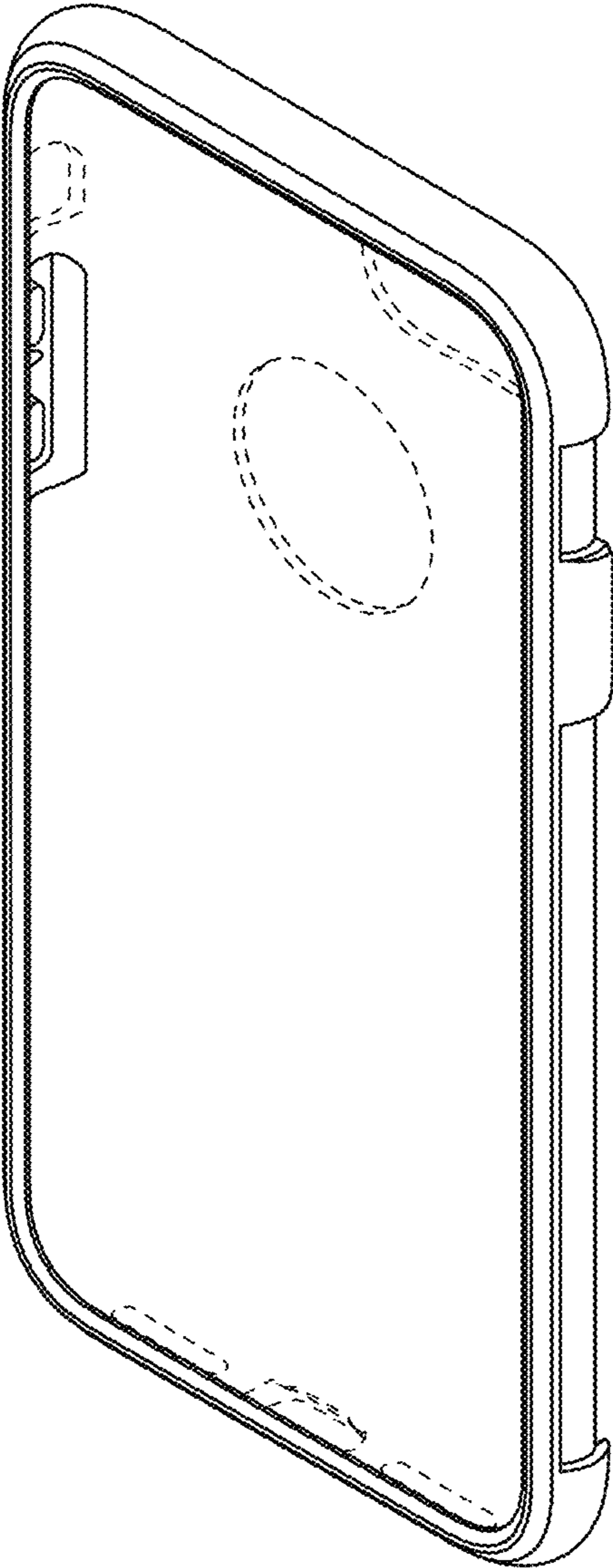

FIG. 10

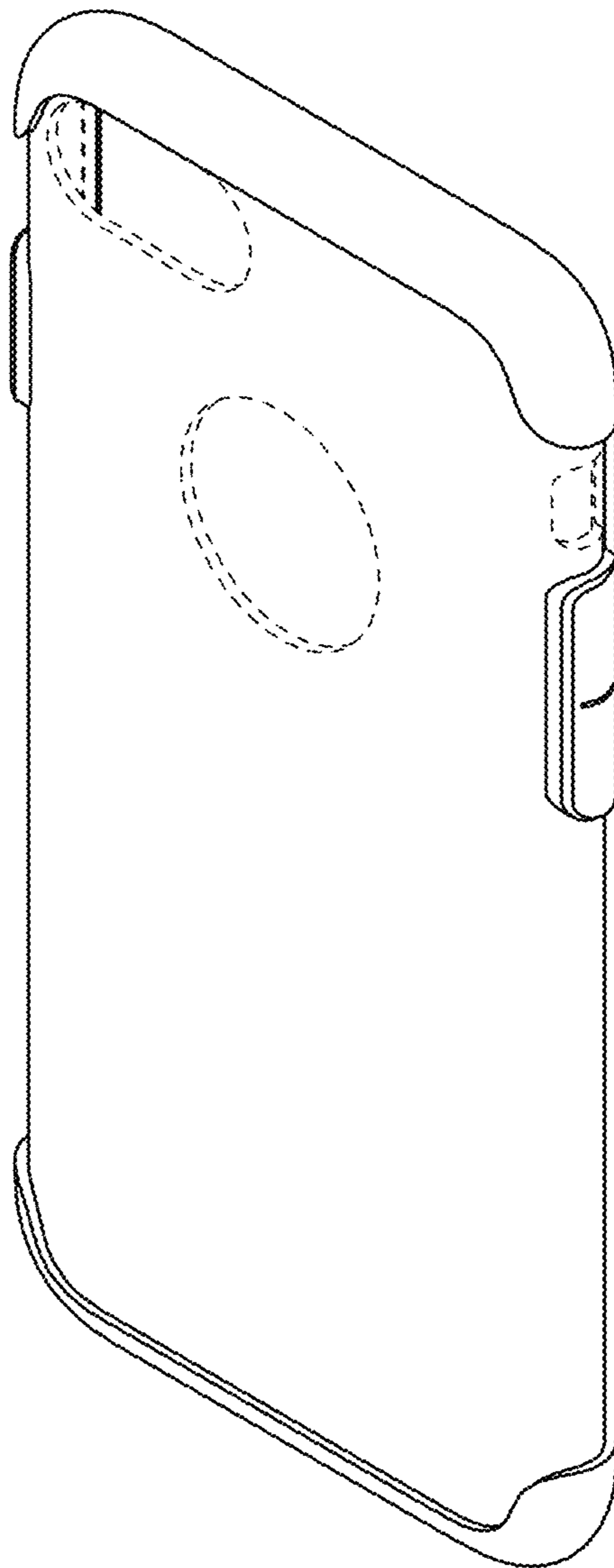

FIG. 11

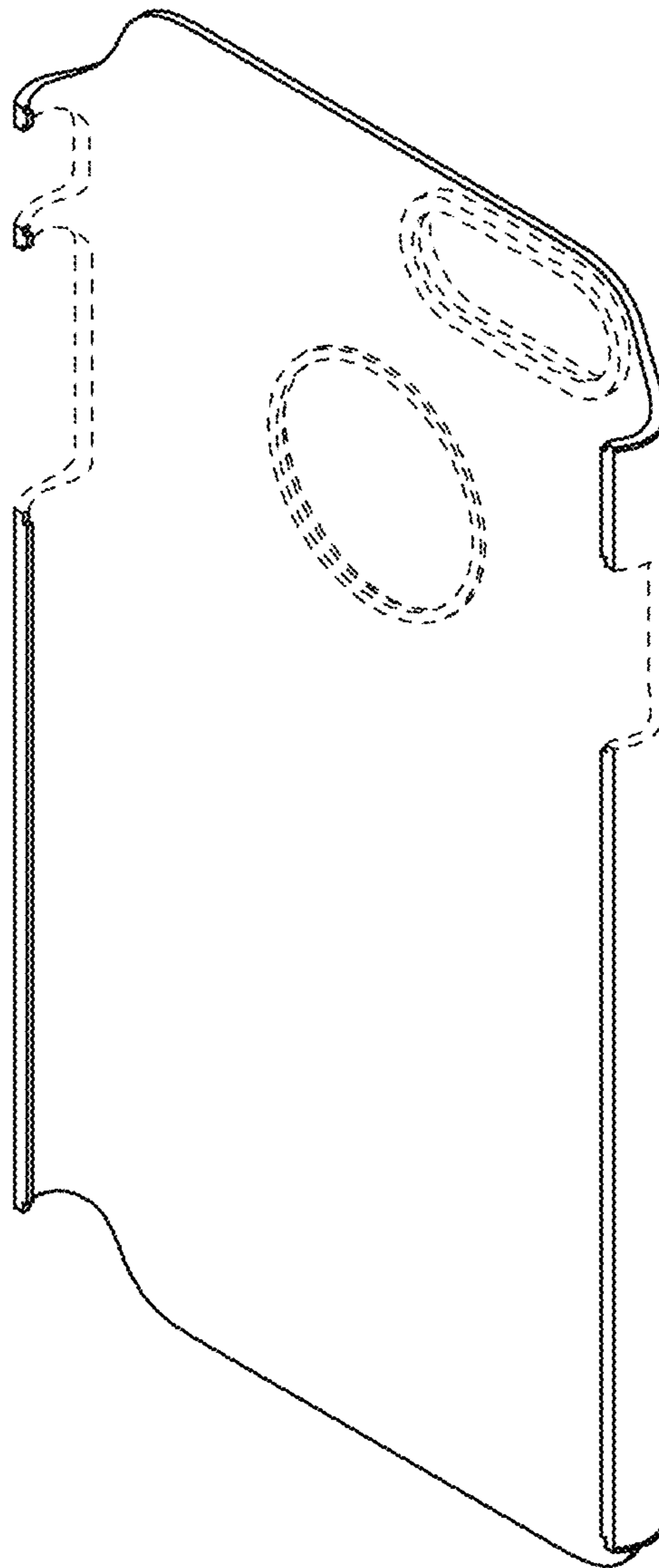

FIG. 12

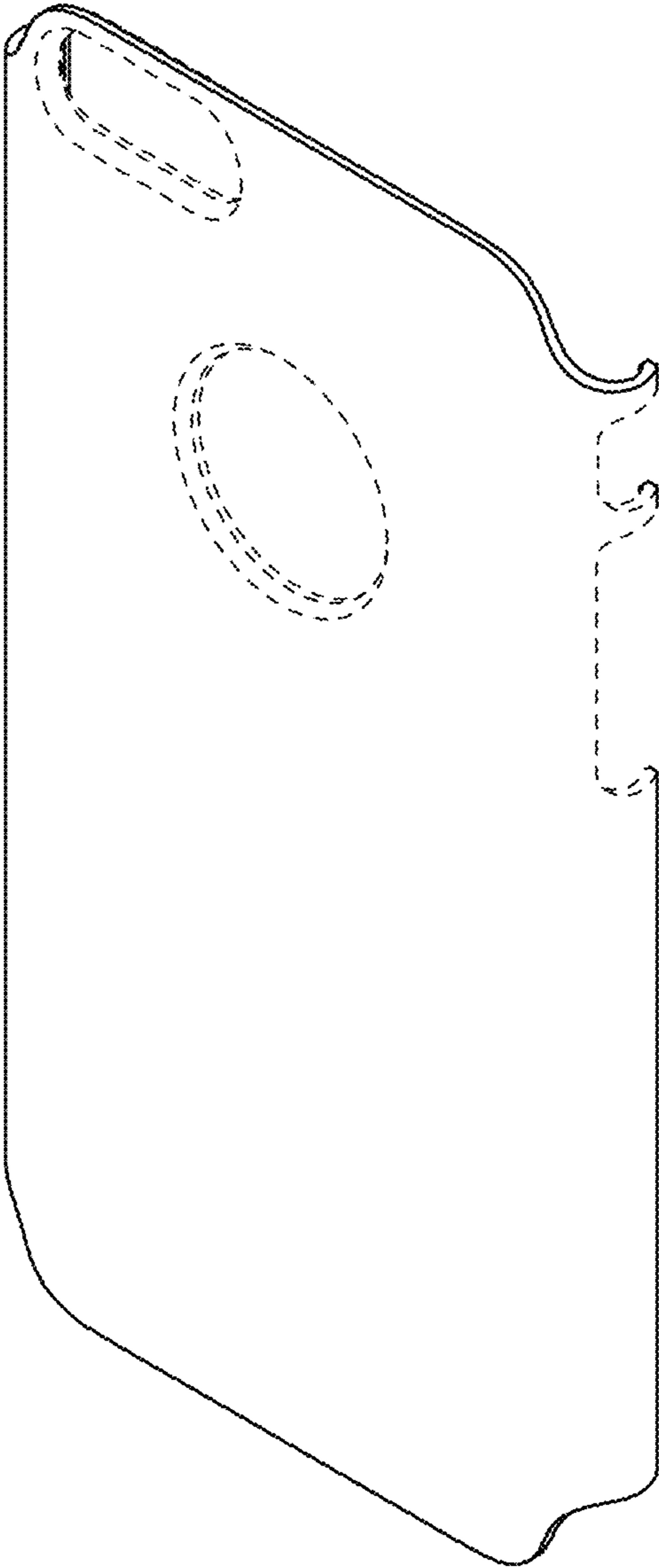

FIG. 13

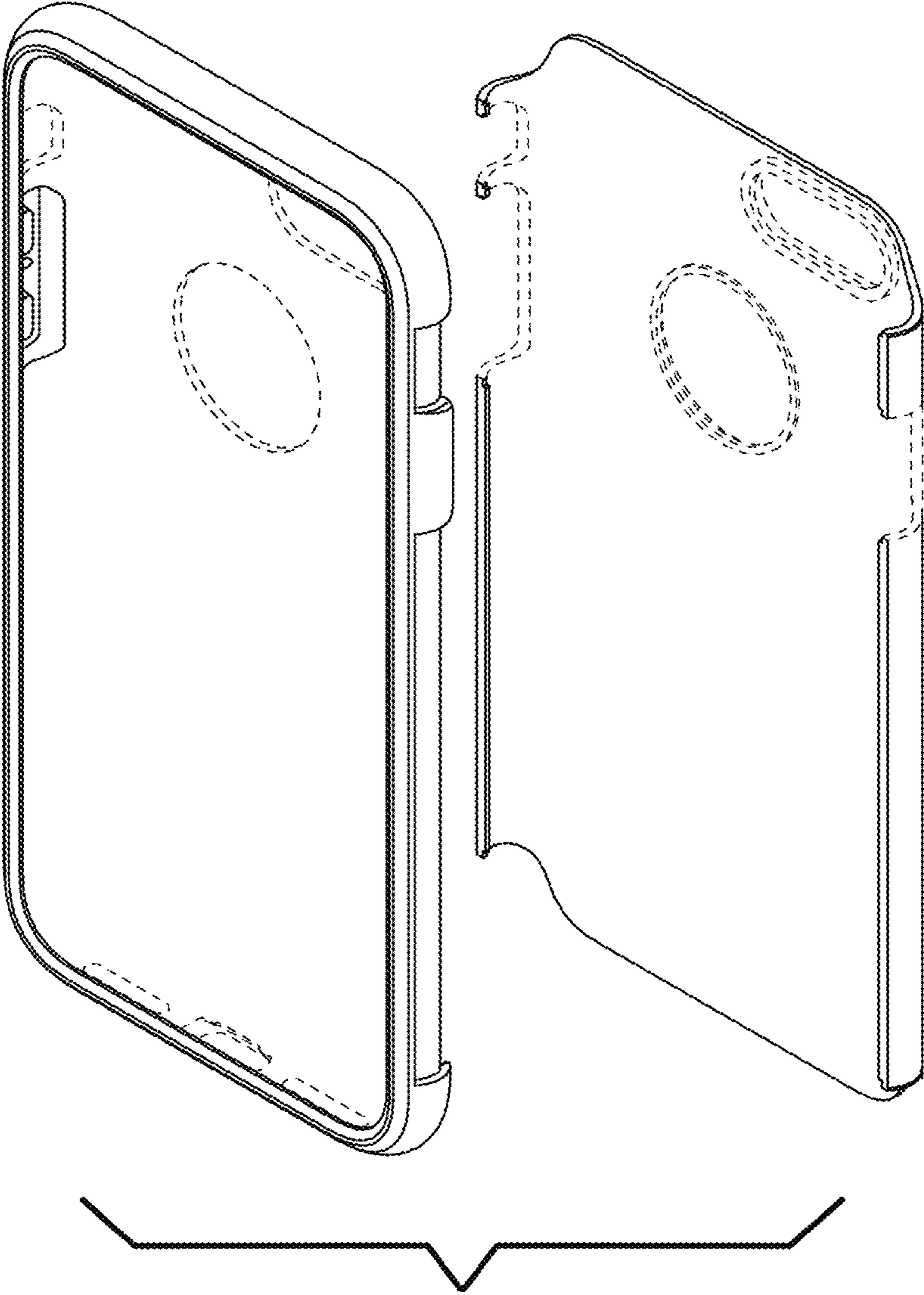

FIG. 14

