



US00D864940S

(12) **United States Design Patent**  
**Kim**

(10) **Patent No.:** **US D864,940 S**

(45) **Date of Patent:** **\*\* \*Oct. 29, 2019**

(54) **CASE FOR ELECTRONIC DEVICE**

(71) Applicant: **SPIGEN KOREA CO., LTD.**, Seoul (KR)

(72) Inventor: **Dae-Young Kim**, Seoul (KR)

(73) Assignee: **SPIGEN KOREA CO., LTD.**, Seoul (KR)

(\*) Notice: This patent is subject to a terminal disclaimer.

(\*\*) Term: **15 Years**

(21) Appl. No.: **29/613,464**

(22) Filed: **Aug. 10, 2017**

**Related U.S. Application Data**

(63) Continuation of application No. 29/593,707, filed on Feb. 10, 2017, now Pat. No. Des. 807,338, which is a continuation of application No. 29/568,017, filed on Jun. 14, 2016, now Pat. No. Des. 788,760, which is a continuation of application No. 29/495,236, filed on Jun. 27, 2014, now Pat. No. Des. 771,607, said application No. 29/593,707 is a continuation of application No. 29/568,020, filed on Jun. 14, 2016, now Pat. No. Des. 791,116, said application No. 29/593,707 is a continuation of application No. 29/568,021, filed on Jun. 14, 2016, now Pat. No. Des. 786,233.

(51) **LOC (12) Cl.** ..... **14-03**

(52) **U.S. Cl.**  
USPC ..... **D14/250**

(58) **Field of Classification Search**  
USPC ..... D14/250–253, 440, 203.3–203.7, 217, D14/496, 248, 238.1, 240, 447, 230, 247, D14/341, 345, 346, 439; D3/201, 218, D3/269, 301, 273, 303; D13/103, D13/107–108

CPC . A45C 2011/002; A45C 11/00; A45C 13/002; A45C 2011/003; H04M 1/0283; H04M 1/0202; H04M 1/185; H04B 1/3888  
See application file for complete search history.

(56) **References Cited**

U.S. PATENT DOCUMENTS

D565,291 S 4/2008 Brandenburg et al.  
D609,463 S 2/2010 Bullen  
(Continued)

OTHER PUBLICATIONS

“iPhone SE 5S 5 Tough Case, Fone-Stuff®—2 Layer Armor Shell Hardback Cover in White (Includes Screen Protector)”, [https://www.amazon.co.uk/iPhone-Touch-Case-Fone-Stuff®-Protector/dp/B00J7Y547O/ref=sr\\_1\\_4](https://www.amazon.co.uk/iPhone-Touch-Case-Fone-Stuff®-Protector/dp/B00J7Y547O/ref=sr_1_4); available online Mar. 24, 2014.

(Continued)

*Primary Examiner* — Holly E Thurman

(74) *Attorney, Agent, or Firm* — Heedong Chae; Lucem, PC

(57) **CLAIM**

The ornamental design for a case for electronic device, as shown and described.

**DESCRIPTION**

FIG. 1 is a front perspective view of a case for electronic device showing my new design;  
FIG. 2 is another front perspective view thereof;  
FIG. 3 is a rear perspective view thereof;  
FIG. 4 is a front elevational view thereof;  
FIG. 5 is a rear elevational view thereof;  
FIG. 6 is a left side elevational view thereof;  
FIG. 7 is a right side elevational view thereof;  
FIG. 8 is a top plan view thereof; and,  
FIG. 9 is a bottom plan view thereof.

The broken lines depict of unclaimed environment and form no part of the claimed design.

**1 Claim, 9 Drawing Sheets**

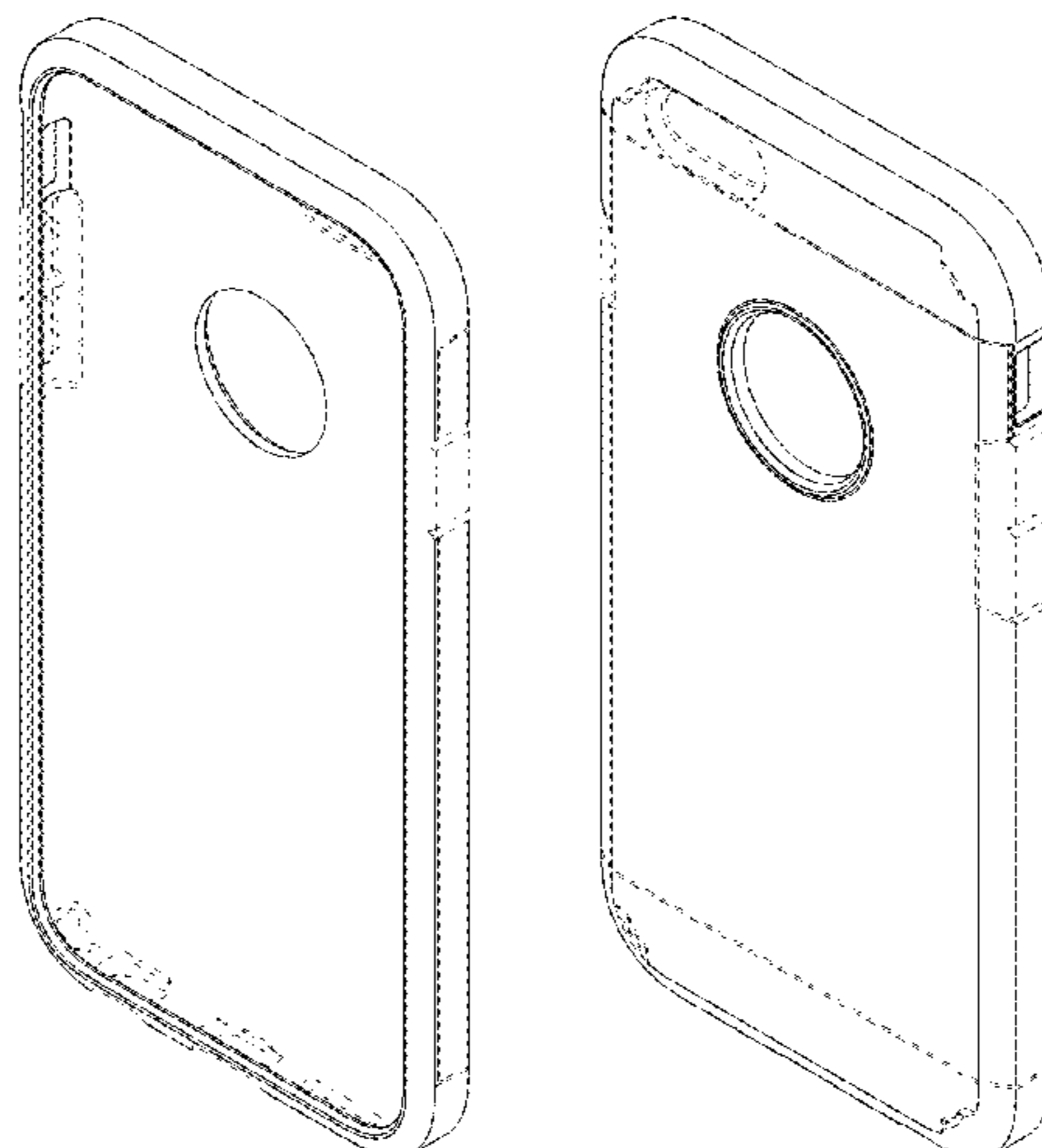

(56)

References Cited

OTHER PUBLICATIONS

U.S. PATENT DOCUMENTS

D621,822 S 8/2010 Richardson et al.  
 D624,064 S 9/2010 Esposito  
 D624,910 S 10/2010 Richardson et al.  
 D644,218 S 8/2011 Akana et al.  
 D657,782 S 4/2012 Biller  
 D659,691 S 5/2012 Kim et al.  
 D662,092 S 6/2012 Bau  
 D676,845 S 2/2013 Melanson et al.  
 D677,249 S 3/2013 Li et al.  
 D677,251 S 3/2013 Melanson et al.  
 D682,260 S 5/2013 Tages et al.  
 D684,150 S 6/2013 Goradesky et al.  
 D685,361 S 7/2013 Goradesky et al.  
 D689,852 S 9/2013 Azoulay  
 8,681,491 B1 3/2014 Cruz et al.  
 D703,652 S 4/2014 Melanson  
 D703,654 S 4/2014 Melanson et al.  
 D703,655 S 4/2014 Melanson  
 D714,274 S 9/2014 Jung et al.  
 D714,278 S 9/2014 Case et al.  
 D721,685 S 1/2015 Hasbrook et al.  
 D729,218 S 5/2015 Willson et al.  
 D732,498 S 6/2015 Huang  
 D736,205 S 8/2015 Park  
 D739,391 S 9/2015 Chen  
 9,143,181 B1 9/2015 Jia et al.  
 D741,279 S 10/2015 Tai  
 D741,844 S 10/2015 Rayner  
 D741,845 S 10/2015 Kim  
 D743,389 S 11/2015 Akana  
 D743,931 S 11/2015 Hubbard  
 D744,471 S 12/2015 Fitzgerald  
 D746,273 S 12/2015 Herbst  
 D746,275 S 12/2015 Mohammad  
 D746,801 S 1/2016 Pan  
 D746,805 S 1/2016 Kim  
 D747,306 S 1/2016 Kim  
 D748,614 S 2/2016 Ju  
 D749,555 S 2/2016 Poon et al.  
 D749,563 S 2/2016 Akana  
 D749,567 S 2/2016 Lee  
 D749,591 S 2/2016 Akana  
 9,247,795 B2 2/2016 Kim  
 D752,037 S 3/2016 Akana  
 9,295,174 B2 3/2016 Witter  
 9,301,414 B2 3/2016 Chao  
 D753,099 S 4/2016 Kim  
 D753,641 S 4/2016 Roberts  
 D754,651 S 4/2016 Roberts  
 D754,652 S 4/2016 Robert  
 D756,340 S 5/2016 Babichenko  
 D756,978 S 5/2016 Addonisio  
 D759,641 S \* 6/2016 Lai ..... D14/250  
 D775,112 S 12/2016 Hemesath et al.  
 2011/0297578 A1 \* 12/2011 Stiehl ..... B29C 45/1676  
 206/701  
 2014/0051488 A1 2/2014 Chung  
 2014/0216952 A1 \* 8/2014 Liang ..... H04M 1/18  
 206/37

“iPhone SE/5s/5/Tone,” <https://www.switcheasy.com/iphone-se5s5/24-tones>, Downloaded Jun. 13, 2016.  
 “Lunatik SMK5-001 Seismik Touch Suspension Frame for iPhone 5/iPhone 5S—Retail Packaging—Black/Smoke,” [https://www.amazon.com/Lunatik-SMK5-001-Seismik-Suspension-iPhone/dp/B00BF780QS?ie=UTF8&\\*Version\\*=1&\\*entries\\*=0](https://www.amazon.com/Lunatik-SMK5-001-Seismik-Suspension-iPhone/dp/B00BF780QS?ie=UTF8&*Version*=1&*entries*=0), Downloaded Jun. 13, 2016.  
 “iPhone 5S/5 Case Slim Armor,” <http://www.spigen.com/products/iphone-5s-5-case-slim-armor-s?variant=1162051877>, Downloaded Jun. 13, 2016.  
 “SGP iPhone 4 Case Neo Hybrid Matte Series Gun Metal”, <https://www.amazon.co.uk/dp/B004F1IQ7E>, Date first available at Amazon.co.uk of Dec. 3, 2010.  
 “SGP Neo Hybrid Matte Series Case for the iPhone 4”, <https://www.youtube.com/watch?v=fOH74451I-8>, Published on Sep. 22, 2010.  
 “Spigen Slim Armor iPhone SE / 5S / 5 Case with Advanced Drop Protection and Dual Layer Design for iPhone SE / iPhone 5S / iPhone 5—Metal Slate”, <https://www.amazon.com/Spigen-iPhone-Advanced-Protection-Design/dp/B00DD62R40>, Earliest review date of Dec. 14, 2012, Downloaded on Sep. 18, 2018.  
 Defendants’ Memorandum in Support of Their Motion for Summary Judgment, filed Oct. 29, 2018, in *Spigen Korea Co., LTD vs. Ultraproof, Inc. et al*, Case No. 2:17-cv-01161 in the United States District Court for the Central District of California.  
 Declaration of Benjamin A. Campbell in Support of Defendants’ Motion for Summary Judgment, filed Oct. 29, 2018, in *Spigen Korea Co., LTD vs. Ultraproof, Inc. et al*, Case No. 2:17-cv-01161 in the United States District Court for the Central District of California.  
 Declaration of Dae-Young Kim in Support of Plaintiff’s Opposition to Defendants’ Motion for Summary Judgment; Covenant Not to Sue Re: Certain Claims of ’283 Patent and ’099 Patent, filed Nov. 21, 2018, in *Spigen Korea Co., LTD vs. Ultraproof, Inc. et al*, Case No. 2:17-cv-01161 in the United States District Court for the Central District of California.  
 Plaintiff’s Opposition to Defendants’ Motion for Summary Judgment, filed Nov. 21, 2018, in *Spigen Korea Co., LTD vs. Ultraproof, Inc. et al*, Case No. 2:17-cv-01161 in the United States District Court for the Central District of California.  
 Defendants’ Reply in Support of Their Motion for Summary Judgment, filed Nov. 28, 2018, in *Spigen Korea Co., LTD vs. Ultraproof, Inc. et al*, Case No. 2:17-cv-01161 in the United States District Court for the Central District of California.  
 Order Granting Defendants’ Motion for Summary Judgment [175]; Denying Plaintiffs Motion for Summary Judgment [167]; and Denying Plaintiffs Motion for Leave to File a Fourth Amended Complaint [172]., dated Dec. 12, 2018, in *Spigen Korea Co., LTD vs. Ultraproof, Inc. et al*, Case No. 2:17-cv-01161 in the United States District Court for the Central District of California.  
 Judgment, dated Dec. 20, 2018, in *Spigen Korea Co., LTD vs. Ultraproof, Inc. et al*, Case No. 2:17-cv-01161 in the United States District Court for the Central District of California.  
 Plaintiff Spigen Korea Co., Ltd.’s Notice of Appeal, filed Jan. 16, 2019, in *Spigen Korea Co., LTD vs. Ultraproof, Inc. et al*, Case No. 2:17-cv-01161 in the United States District Court for the Central District of California.

\* cited by examiner

FIG. 1

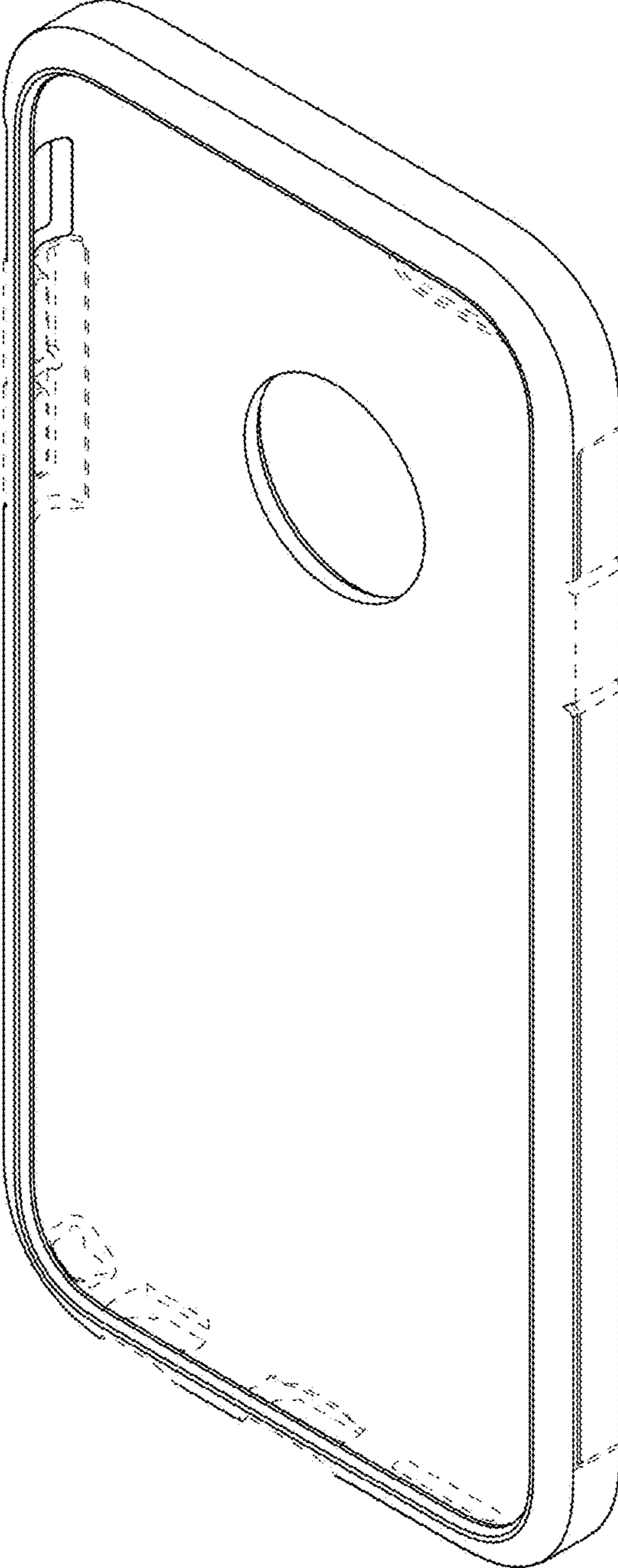

FIG. 2

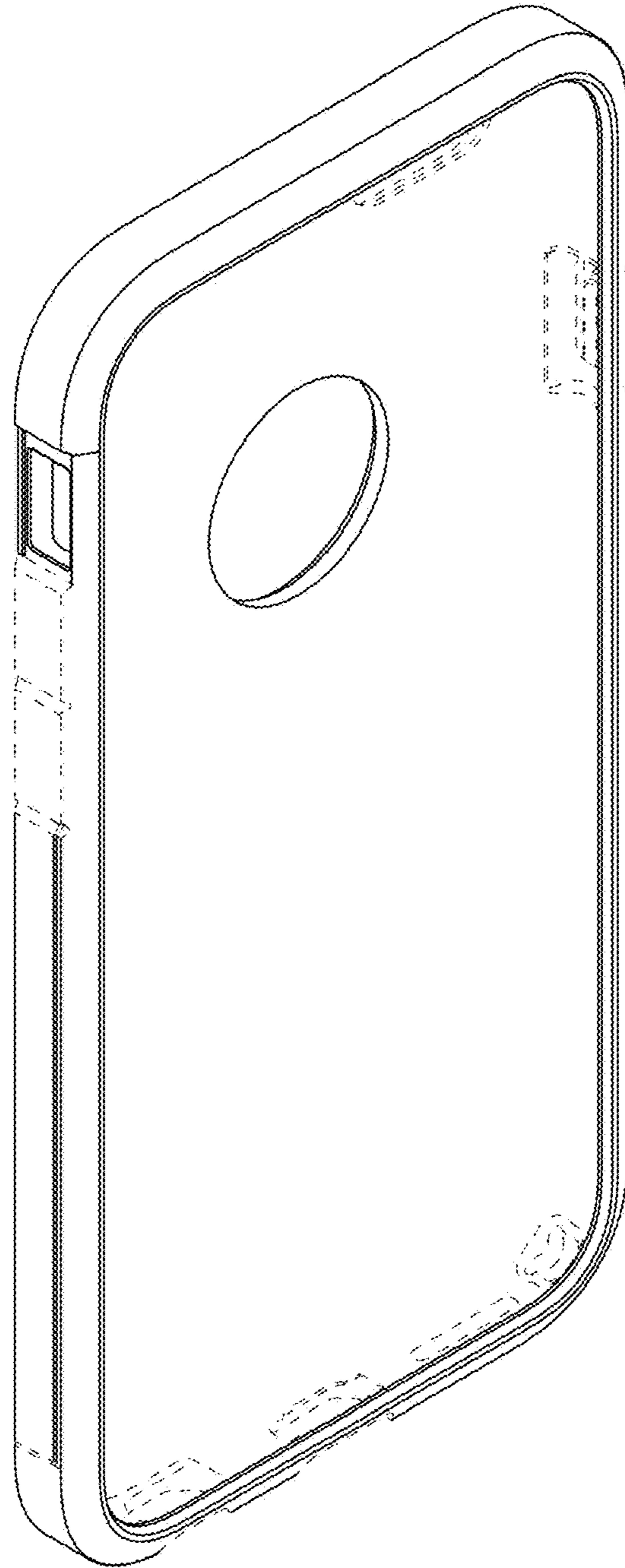

FIG. 3

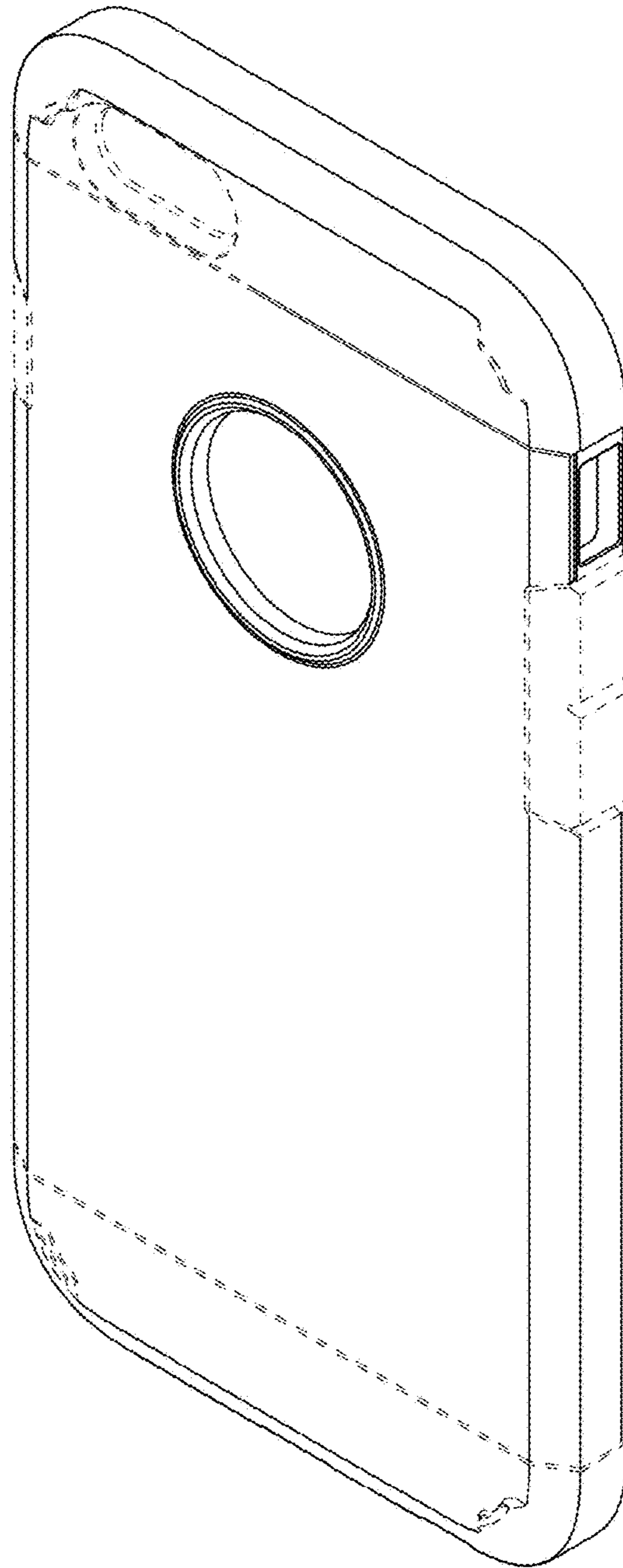

FIG. 4

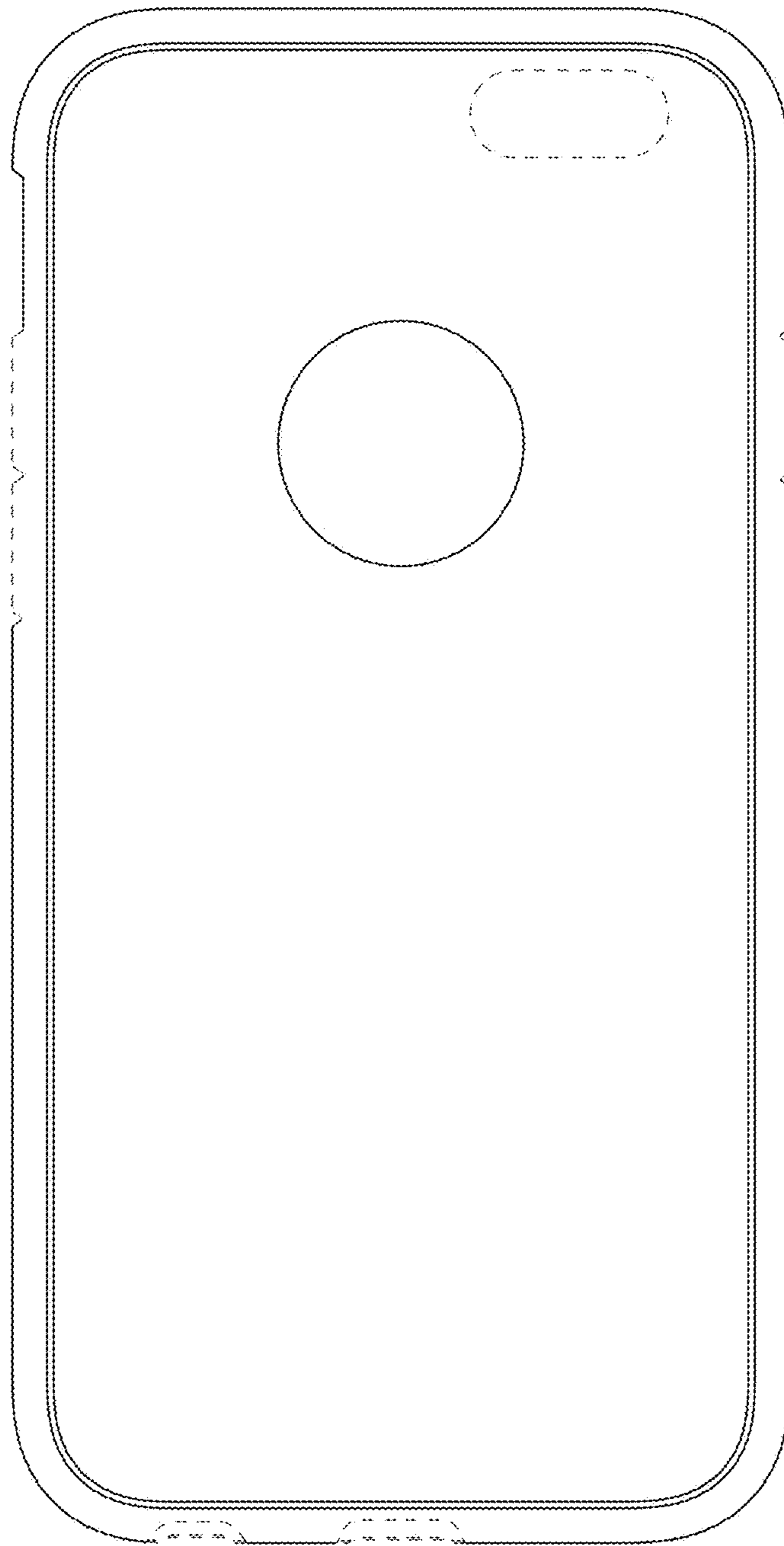

FIG. 5

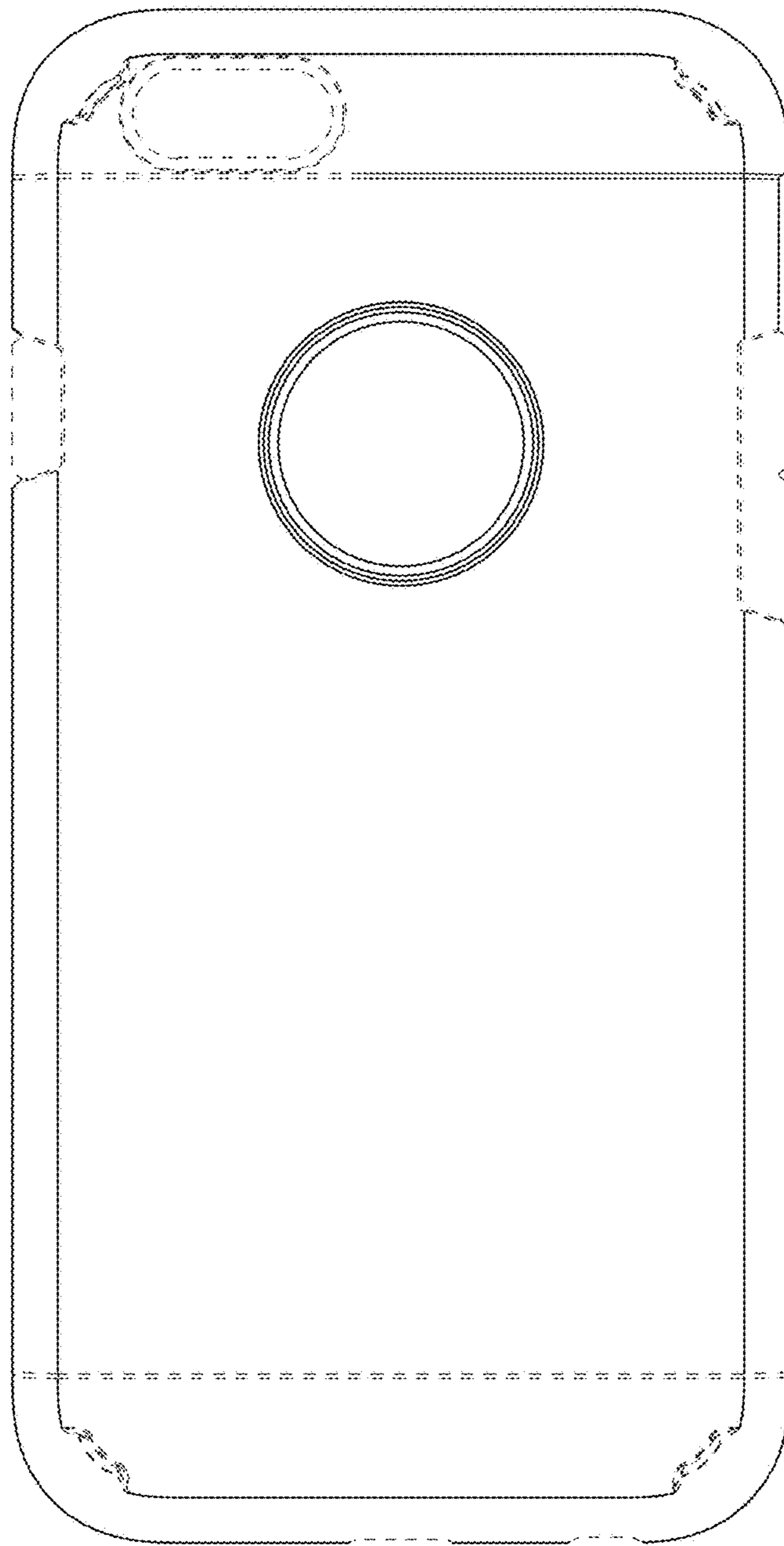

FIG. 6

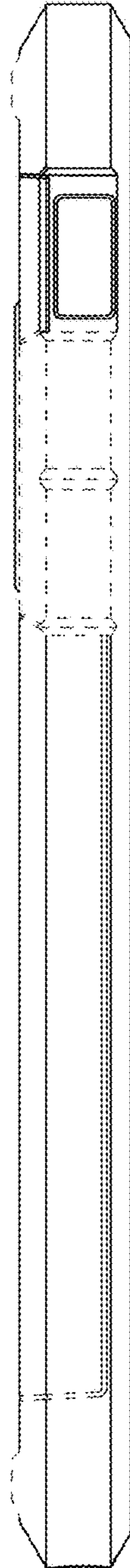



FIG. 7

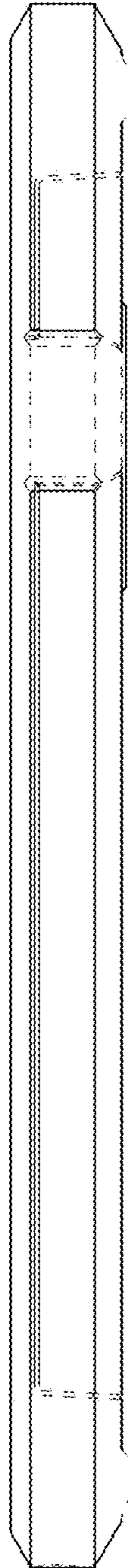

FIG. 8

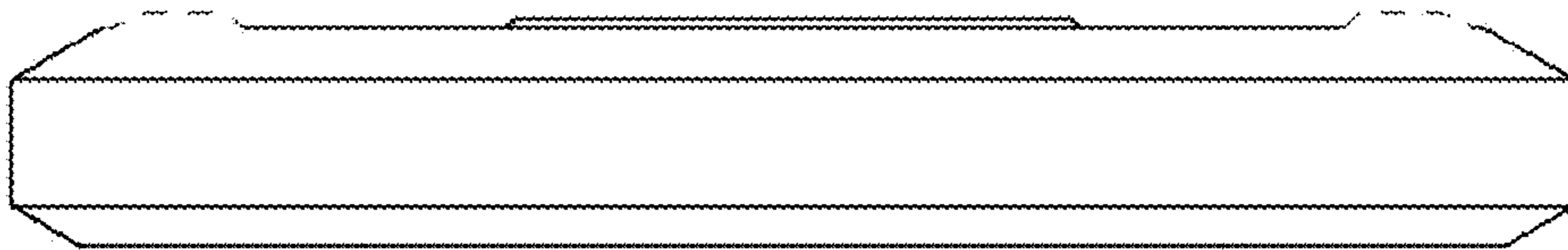

FIG. 9

