



US00D864934S

(12) **United States Design Patent**
Park et al.

(10) **Patent No.:** **US D864,934 S**

(45) **Date of Patent:** **** Oct. 29, 2019**

(54) **MOBILE PHONE**

(71) Applicant: **Samsung Electronics Co., Ltd.**,
Suwon-si (KR)

(72) Inventors: **Hyoungshin Park**, Seoul (KR);
Dongkyun Kim, Seoul (KR); **Yunjin Kim**, Seoul (KR); **Seonkeun Park**,
Seoul (KR); **Seungho Jang**,
Seongnam-si (KR)

(73) Assignee: **Samsung Electronics Co., Ltd.**,
Suwon-si (KR)

(**) Term: **15 Years**

(21) Appl. No.: **29/656,388**

(22) Filed: **Jul. 12, 2018**

(30) **Foreign Application Priority Data**

Jan. 12, 2018 (KR) 30-2018-0002202

(51) **LOC (12) Cl.** **14-03**

(52) **U.S. Cl.**
USPC **D14/248**

(58) **Field of Classification Search**
USPC D14/138 G, 248, 341, 371, 374, 138 R,
D14/138 AA, 138 AB, 138 AC, 138 AD,
D14/138 C, 247

(Continued)

(56) **References Cited**

U.S. PATENT DOCUMENTS

D585,411 S * 1/2009 Eaton D14/138 G
D622,248 S * 8/2010 Kwon D14/138 AD

(Continued)

OTHER PUBLICATIONS

Samsung Galaxy S10 5G, announced Feb. 2019, [online], [retrieved on May 22, 2019]. Retrieved from Internet ,<URL: <http://www.gsmarena.com>>.*

(Continued)

Primary Examiner — Bridget L Eland

(74) *Attorney, Agent, or Firm* — NSIP Law

(57) **CLAIM**

We claim the ornamental design for a mobile phone, as shown and described.

DESCRIPTION

FIG. 1 is a front perspective view of a first embodiment of a mobile phone showing our new design;
FIG. 2 is a front view thereof;
FIG. 3 is a rear view thereof;
FIG. 4 is a left-side view thereof;
FIG. 5 is a right-side view thereof;
FIG. 6 is a top view thereof;
FIG. 7 is a bottom view thereof;
FIG. 8 is a rear perspective view thereof;
FIG. 9 is a front perspective view of a second embodiment thereof;
FIG. 10 is a front view thereof;
FIG. 11 is a rear view thereof;
FIG. 12 is a left-side view thereof;
FIG. 13 is a right-side view thereof;
FIG. 14 is a top view thereof;
FIG. 15 is a bottom view thereof;
FIG. 16 is a rear perspective view thereof;
FIG. 17 is an enlarged view of the encircled portion in FIG. 2; and,
FIG. 18 is an enlarged view of the encircled portion in FIG. 10.

The evenly-spaced broken lines in the figures depict portions of the mobile phone that form no part of the claimed design. The dot-dash broken lines in the figures represent a boundary of the claimed design and form no part thereof. The dot-dot-dash broken lines in FIGS. 2, 10, 17, and 18 encircle portions of the claimed design that are illustrated in enlargements and form no part of the claimed design.

1 Claim, 14 Drawing Sheets

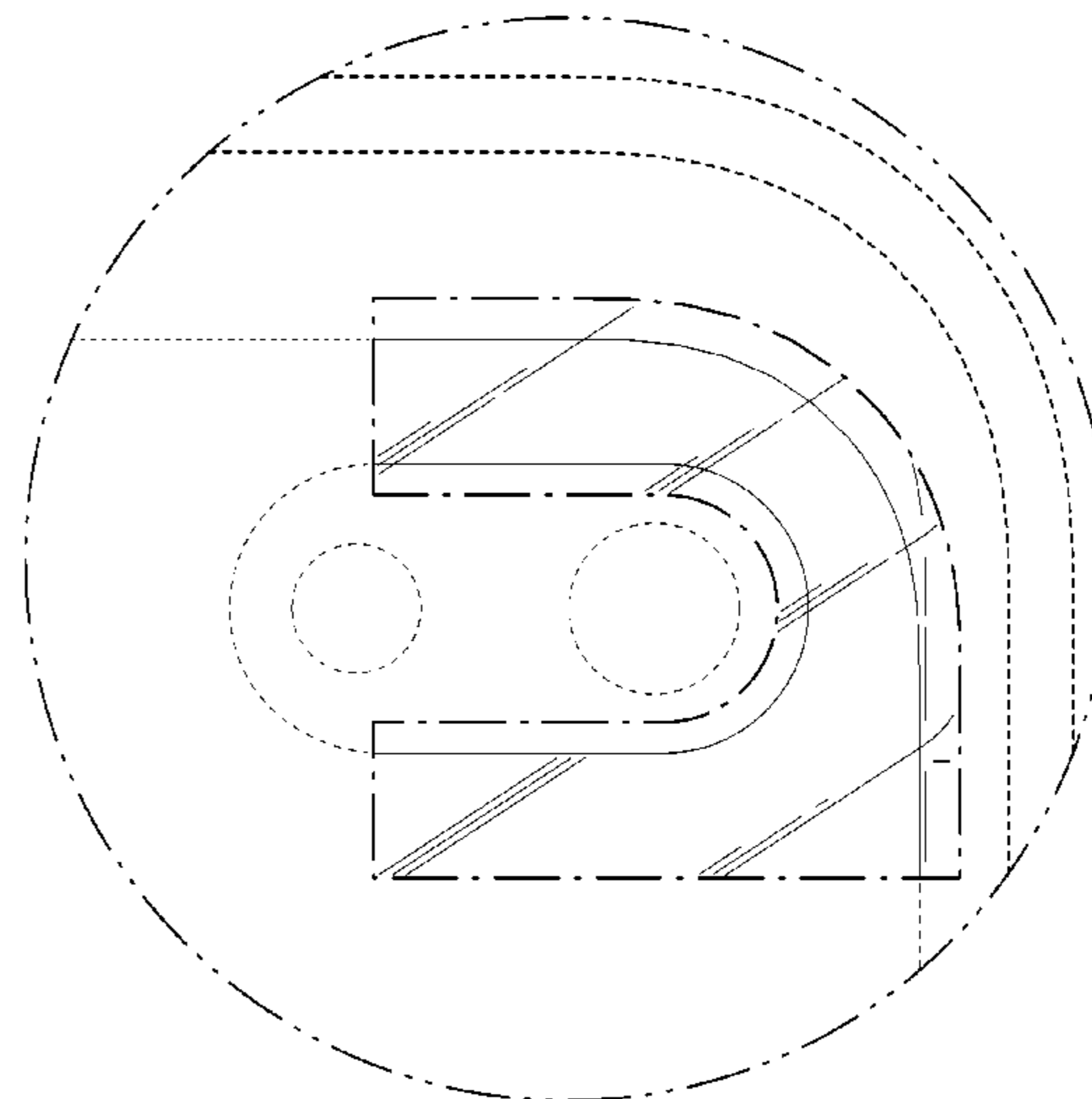
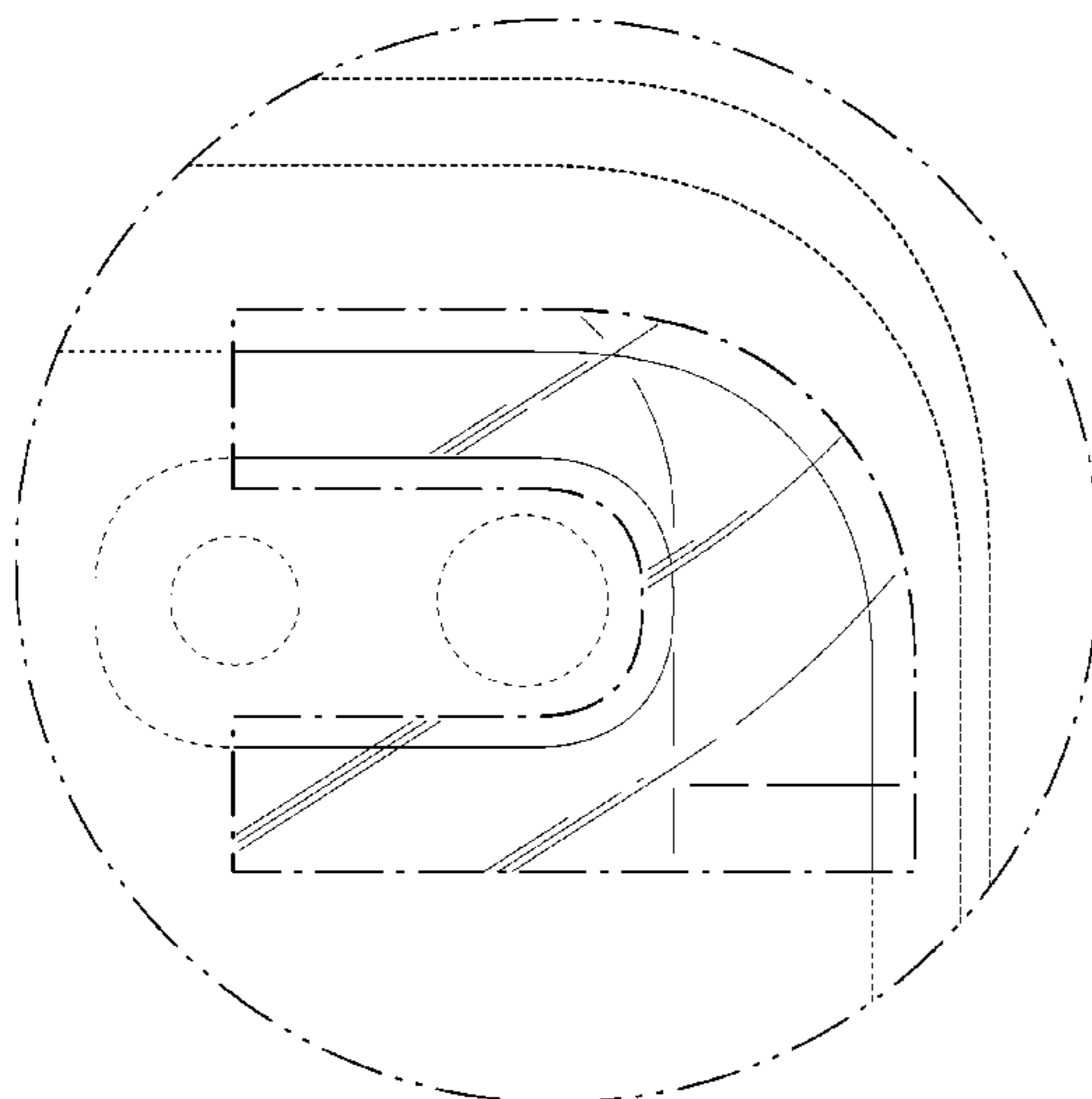

(58) **Field of Classification Search**
 CPC H04M 1/0202; H04M 1/0235; H04M
 1/0237; H04M 1/0239; H04M 1/0266;
 H04M 1/0268; H04M 1/027; H04M
 1/0295
 See application file for complete search history.

D791,096 S * 7/2017 Hu D14/138 G
 D797,726 S * 9/2017 Lee D14/341
 D800,681 S * 10/2017 Kim D14/138 AA
 D817,297 S * 5/2018 Lee D14/138 G
 D845,287 S * 4/2019 Lee D14/248
 D846,539 S * 4/2019 Choe D14/248
 D847,777 S * 5/2019 Choi D14/138 G

(56) **References Cited**

U.S. PATENT DOCUMENTS

D645,011 S * 9/2011 Min D14/138 AD
 D646,251 S * 10/2011 Park D14/138 G
 D648,299 S * 11/2011 Kim D14/138 G
 D648,300 S * 11/2011 Park D14/138 G
 D665,766 S * 8/2012 Eguchi D14/138 G
 D694,214 S * 11/2013 Kim D14/138 G
 D696,221 S * 12/2013 Lee D14/138 G
 D700,161 S * 2/2014 Yoshihara D14/138 G
 D700,589 S * 3/2014 Yoo D14/138 G
 D703,174 S * 4/2014 Suk D14/138 G
 D711,341 S * 8/2014 Shin D14/138 G
 D720,318 S * 12/2014 Kim D14/138 G
 D722,038 S * 2/2015 Cheng D14/138 G
 D738,843 S * 9/2015 Yoon D14/138 G
 D765,068 S * 8/2016 Min D14/248
 D777,699 S * 1/2017 Yuan D14/138 G
 D784,281 S * 4/2017 Ryu D14/138 G

OTHER PUBLICATIONS

Samsung Galaxy S10+, announced Feb. 2019, [online], [retrieved on May 22, 2019]. Retrieved from Internet ,<URL: <http://www.gsmarena.com>>.*
 Samsung Galaxy S10e, announced Feb. 2019, [online], [retrieved on May 22, 2019]. Retrieved from Internet ,<URL: <http://www.gsmarena.com>>.*
 Nokia X71, announced Apr. 2019, [online], [retrieved on May 22, 2019]. Retrieved from Internet ,<URL: <http://www.gsmarena.com>>.*
 Motorola One Vision, announced May 2019, [online], [retrieved on May 22, 2019]. Retrieved from Internet ,<URL: <http://www.gsmarena.com>>.*
 Honor 20, announced May 2019, [online], [retrieved on May 22, 2019]. Retrieved from Internet ,<URL: <http://www.gsmarena.com>>.*

* cited by examiner

FIG. 1

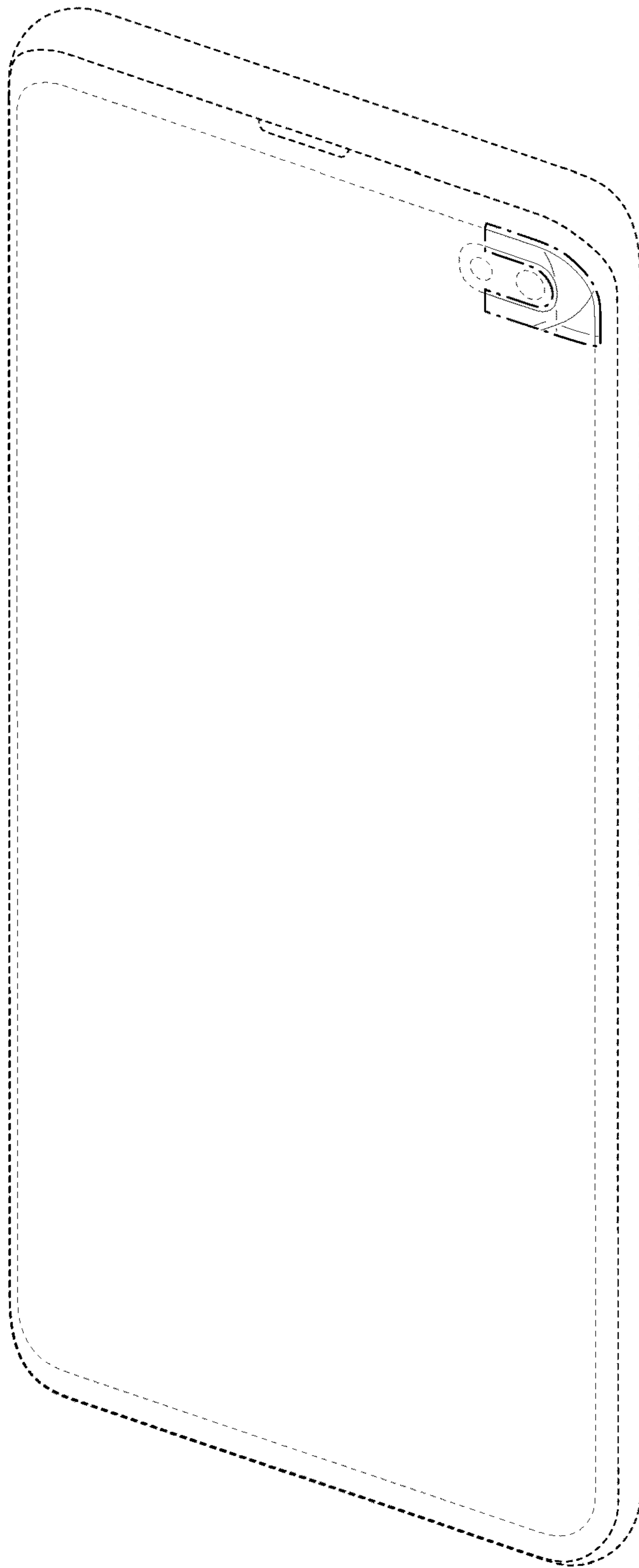

FIG. 2

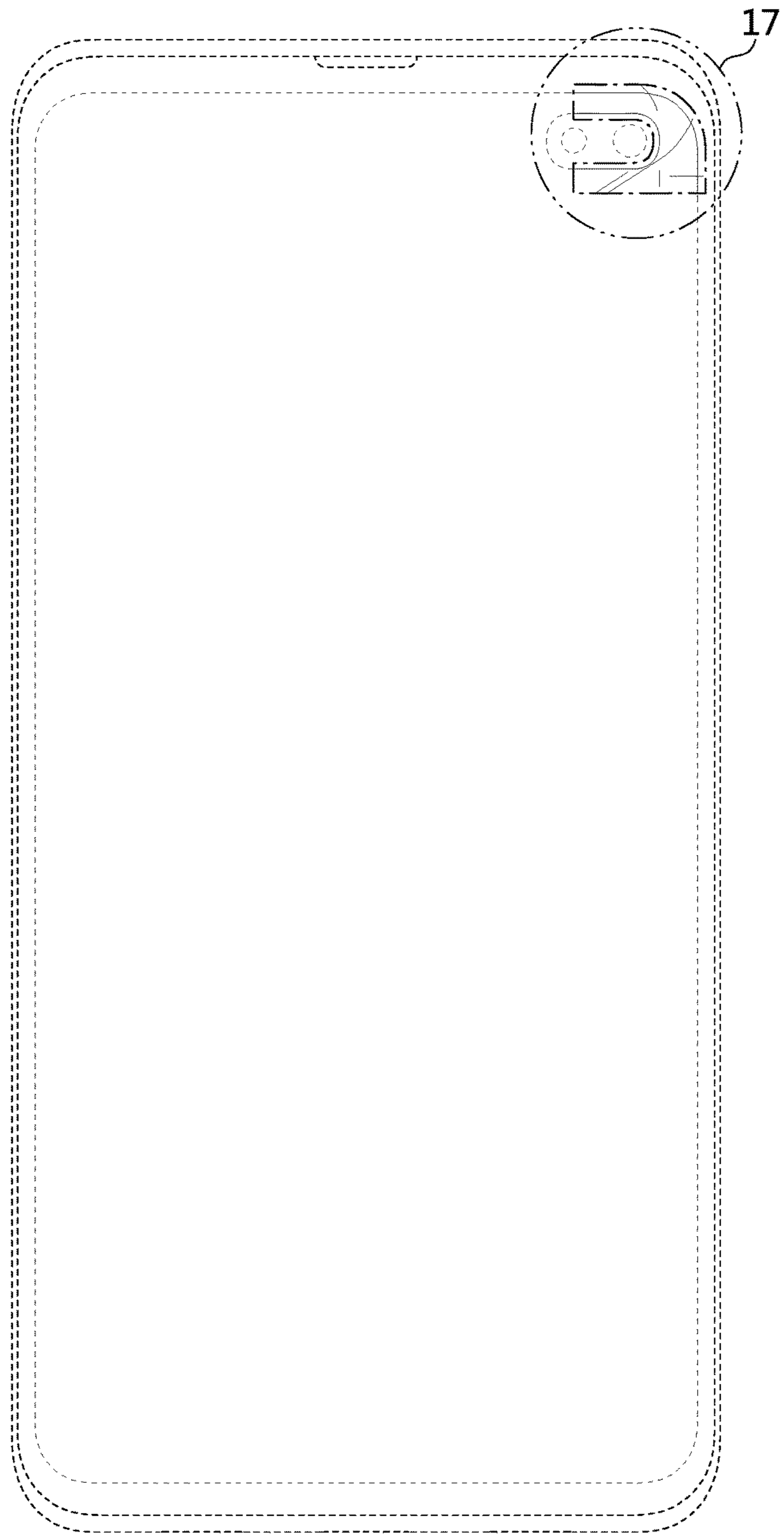

FIG. 3

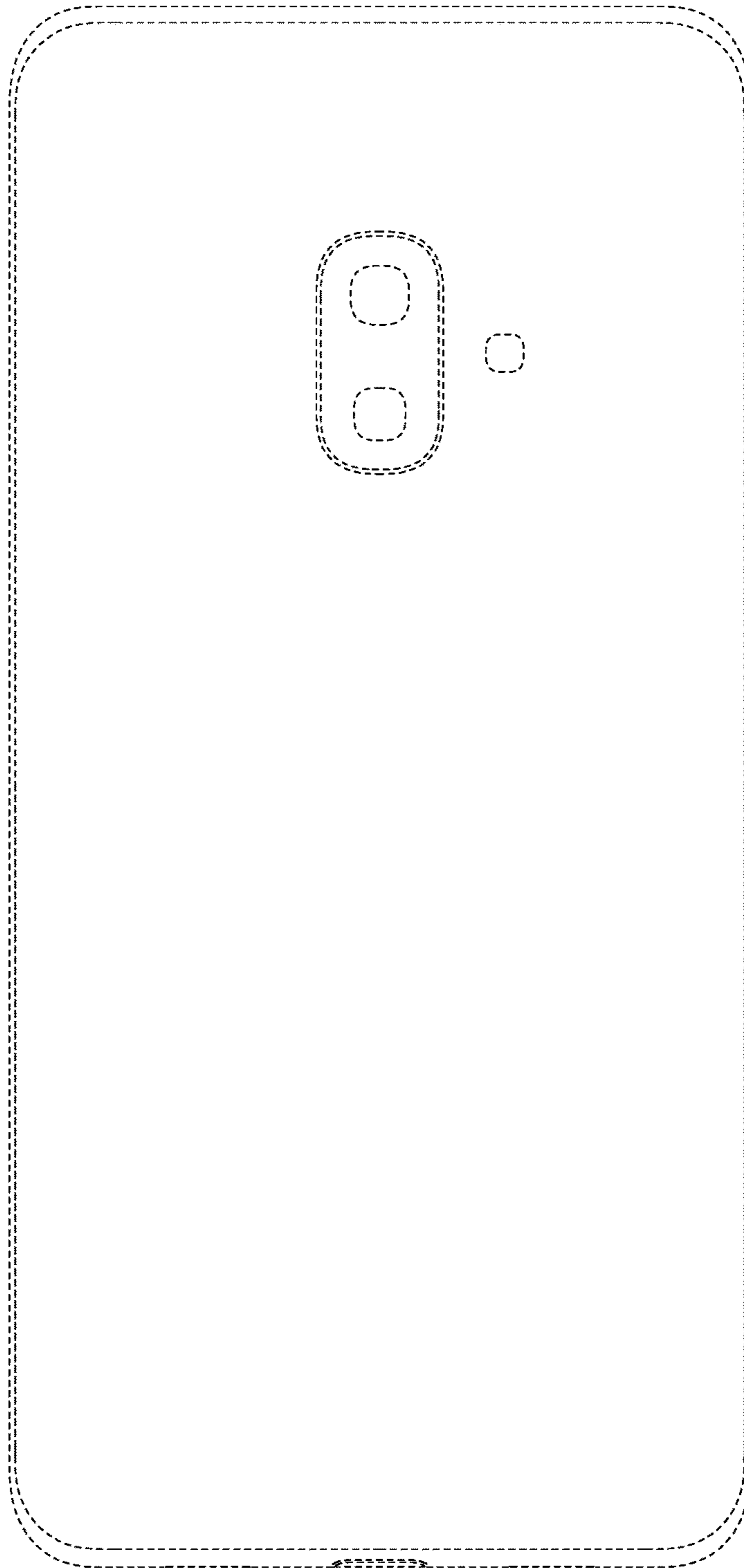

FIG. 4

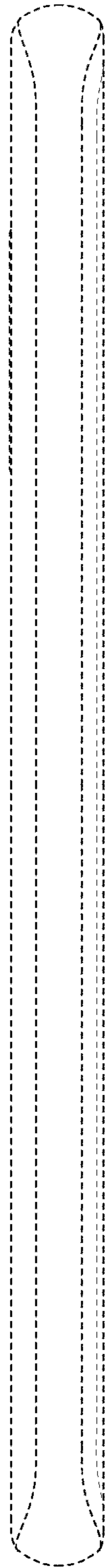

FIG. 5

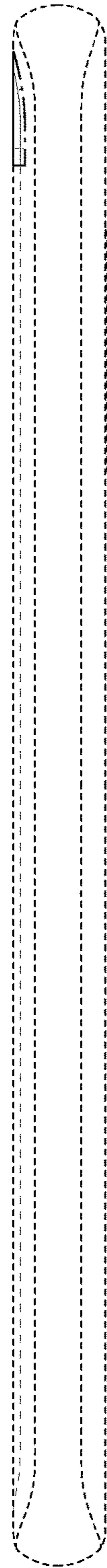

FIG. 6



FIG. 7

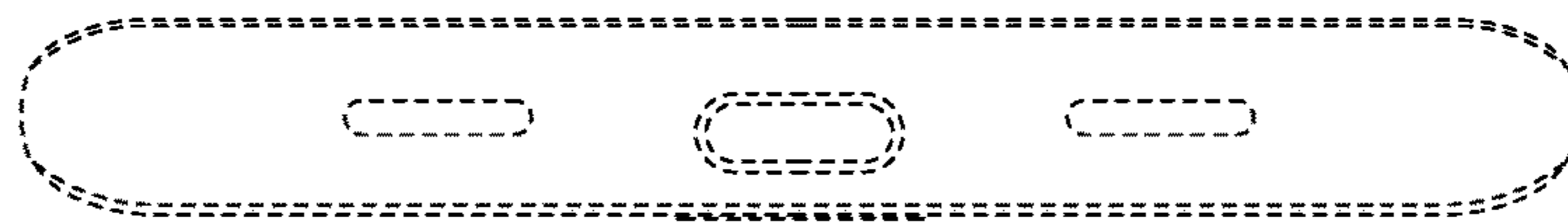

FIG. 8

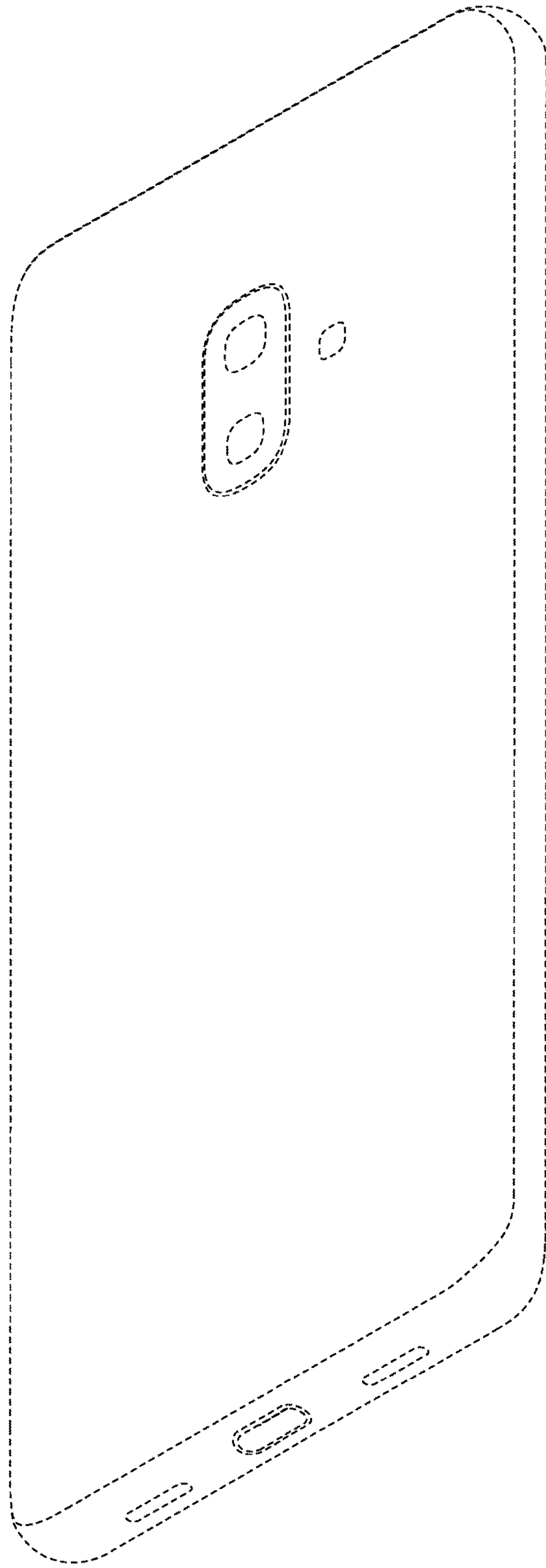

FIG. 9

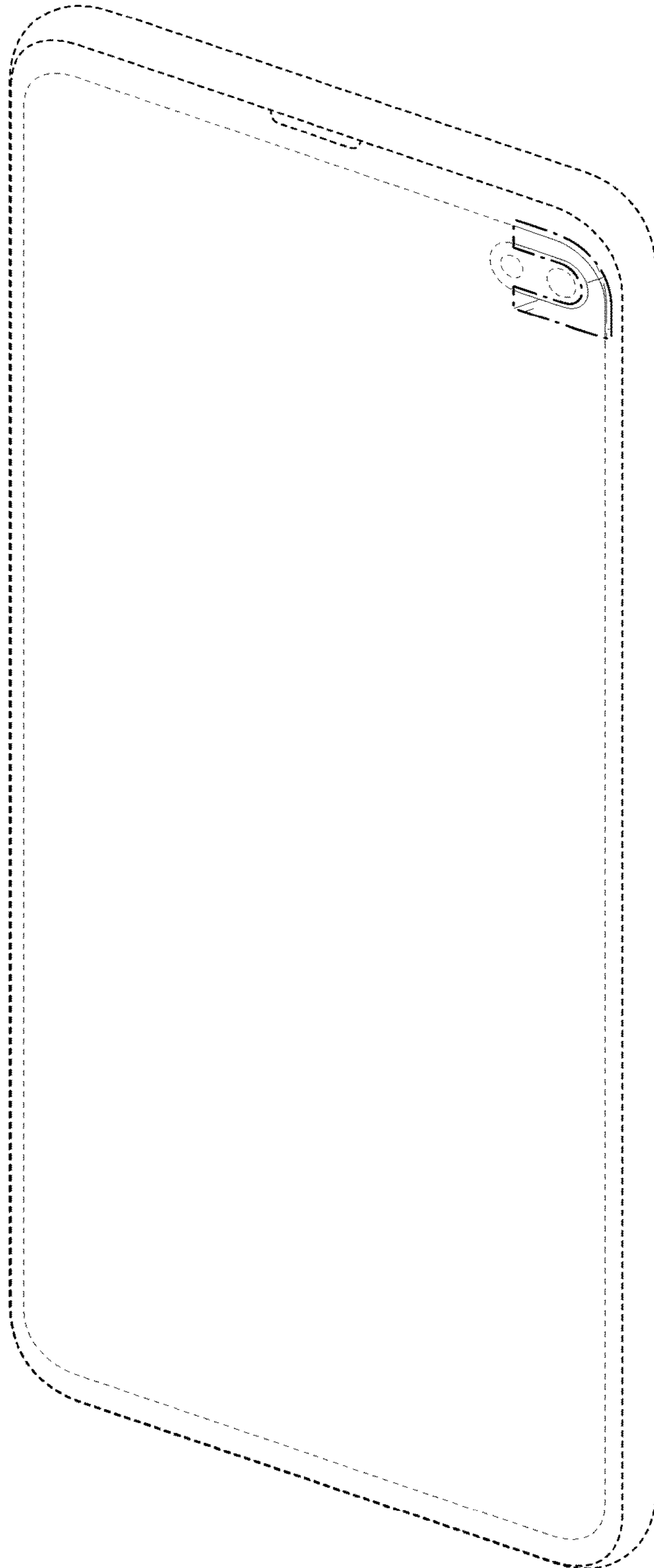

FIG. 10

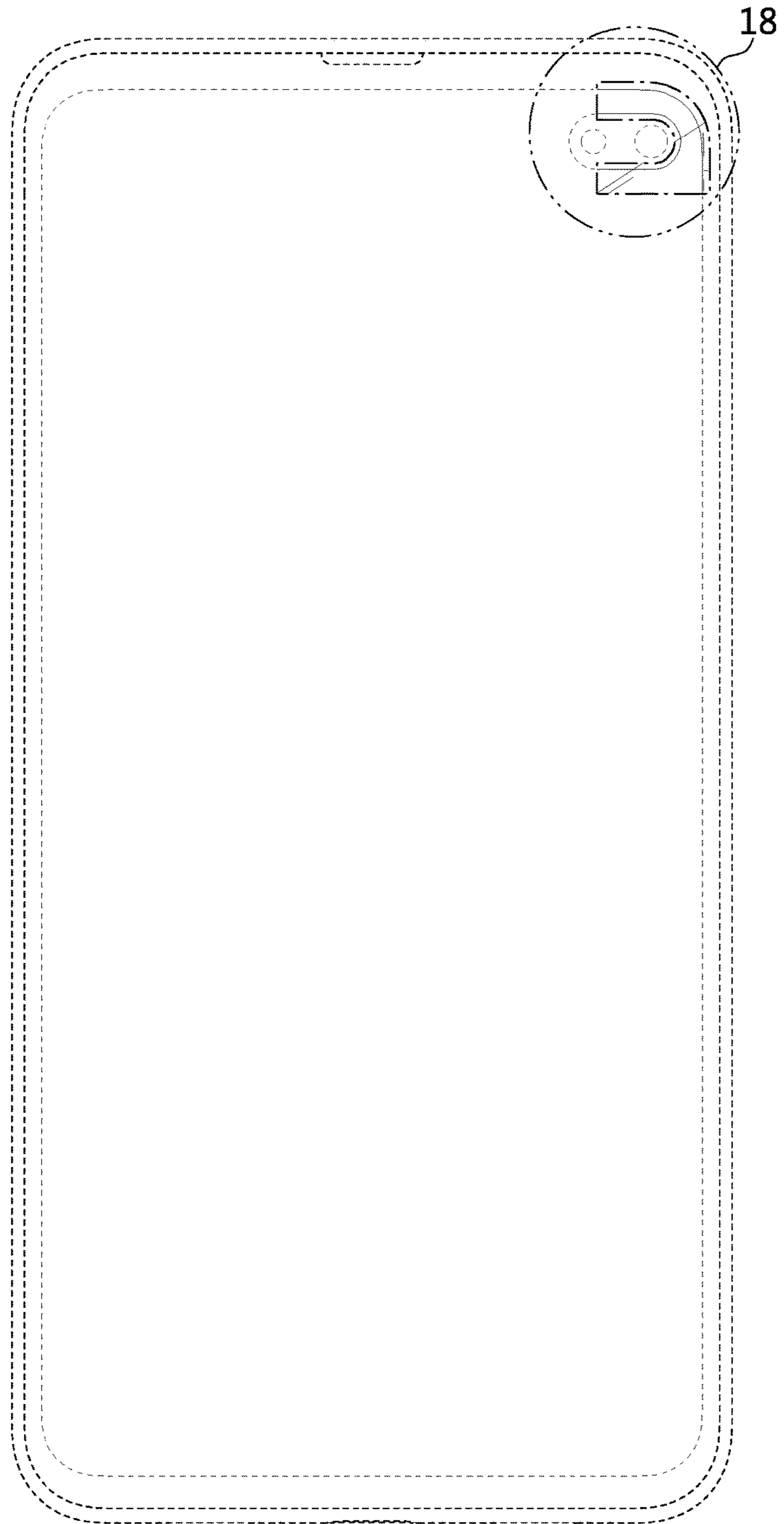

FIG. 11

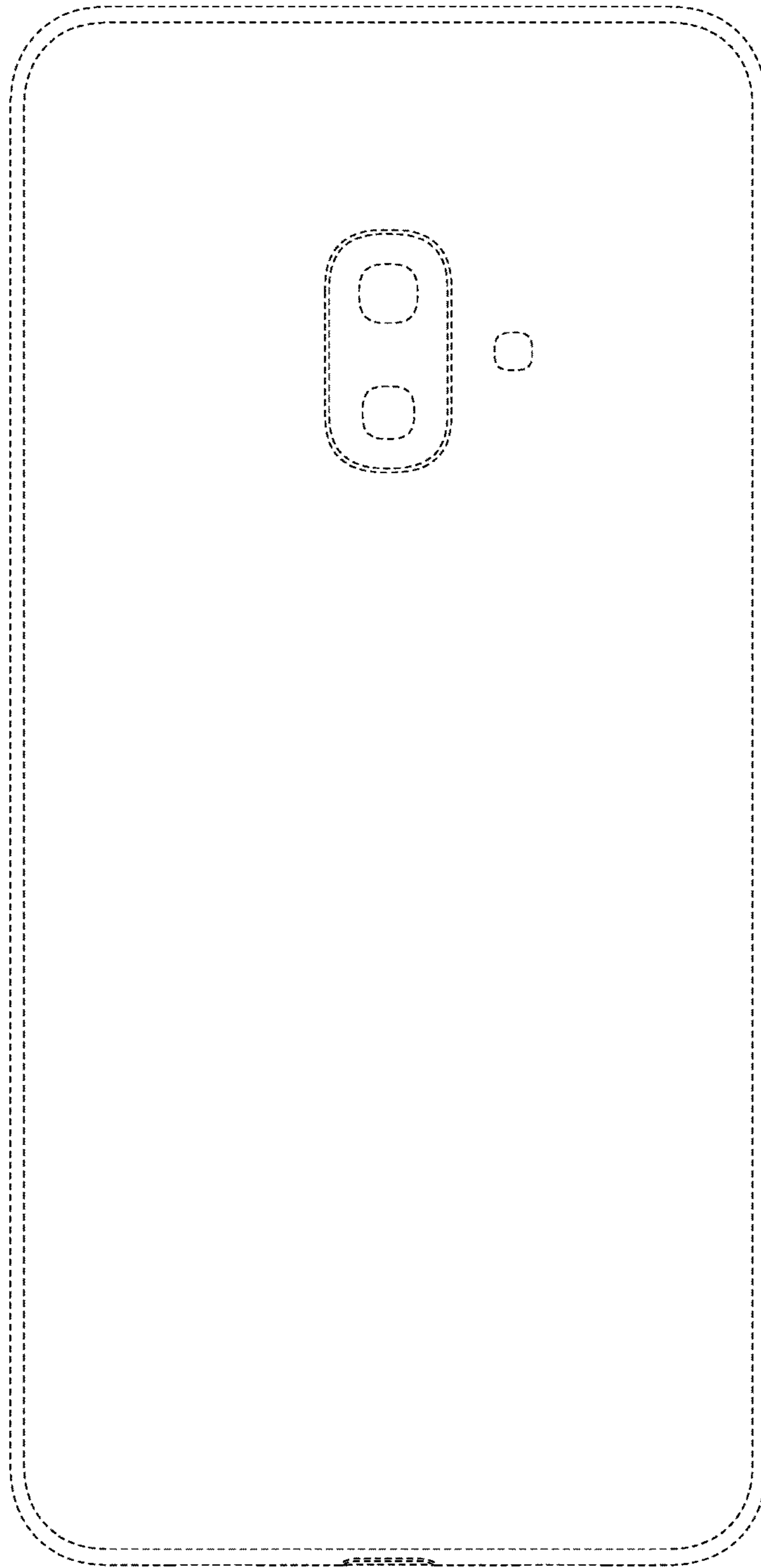

FIG. 12



FIG. 13

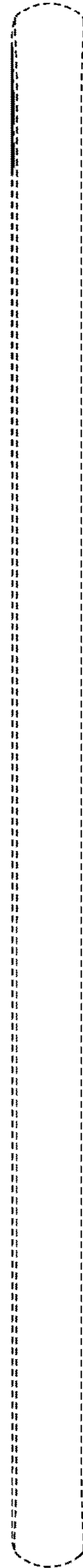

FIG. 14



FIG. 15



FIG. 16

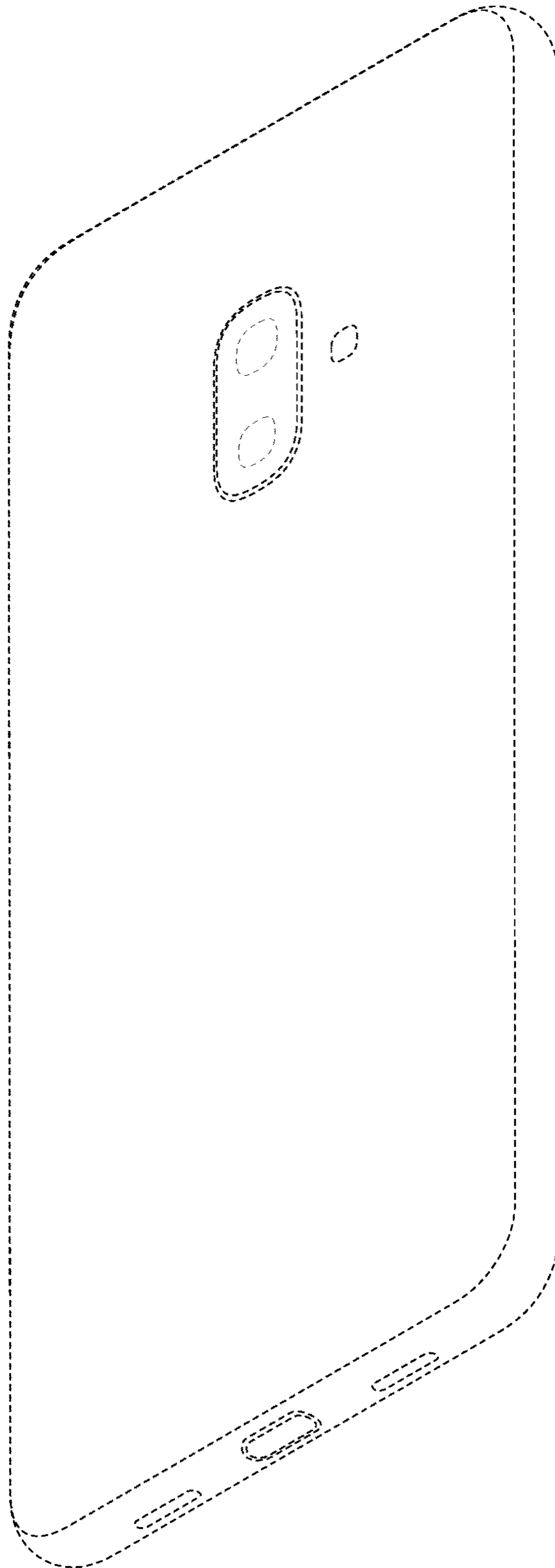

FIG. 17

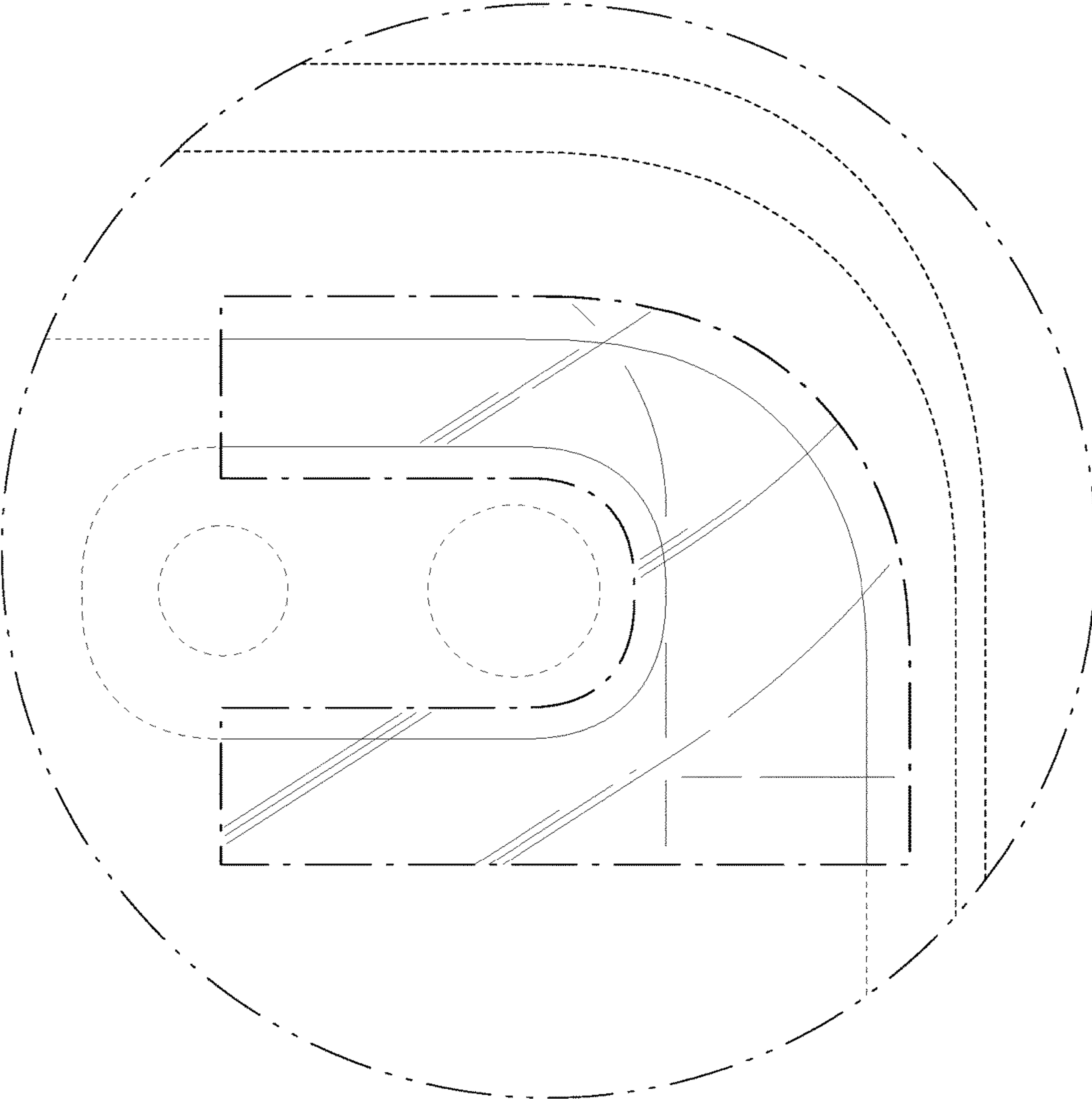

FIG. 18

