



US00D864906S

(12) **United States Design Patent**  
**Roberts**

(10) **Patent No.:** **US D864,906 S**

(45) **Date of Patent:** **\*\* Oct. 29, 2019**

(54) **PORTABLE LOUDSPEAKER**

(71) Applicant: **James Christopher Roberts**, St Martin (JE)

(72) Inventor: **James Christopher Roberts**, St Martin (JE)

(73) Assignee: **Flashbay Electronics Hong Kong Limited**, Hong Kong (HK)

(\*\*) Term: **15 Years**

(21) Appl. No.: **29/616,592**

(22) Filed: **Sep. 7, 2017**

(51) **LOC (12) Cl.** ..... **14-01**

(52) **U.S. Cl.**  
USPC ..... **D14/210**

(58) **Field of Classification Search**  
USPC ..... D14/167, 168, 170–172, 188, 194–198, D14/204, 207, 209.1, 210–216, 219, 221, D14/222, 224, 496; 181/143, 144, 147, 181/148, 150, 153, 157, 198, 199; 369/6–12; 381/300–303, 306, 332–334, 381/336, 345, 361–364, 386–388  
CPC ..... B60R 11/0217; G06F 1/1688; G10K 9/22; G10K 11/004; H03F 1/327; H04M 1/03; H04M 1/035; H04N 5/642; H04N 21/4852; H04S 3/00; H04S 7/30; H04R 1/02; H04R 1/06; H04R 1/021; H04R 1/025; H04R 1/026; H04R 1/028; H04R 1/105; H04R 1/323; H04R 1/403; H04R 1/2803; H04R 1/2834; H04R 5/02; H04R 7/20; H04R 9/06; H04R 9/025; H04R 2201/021; H04R 2400/00; H04R 2400/07; H04R 2499/11; H04R 2499/13; H04R 2499/15

See application file for complete search history.

(56) **References Cited**

U.S. PATENT DOCUMENTS

D540,782 S \* 4/2007 Katsumata ..... D14/214  
D558,788 S \* 1/2008 Yu ..... D14/496

D561,174 S \* 2/2008 Ching ..... D14/214  
D566,101 S \* 4/2008 Griffin ..... D14/214  
D571,355 S \* 6/2008 Koizumi ..... D14/214  
D579,915 S \* 11/2008 Yeo ..... D14/214  
D594,002 S \* 6/2009 Kettula ..... D14/240  
D598,006 S \* 8/2009 Tse ..... D14/209.1  
D599,782 S \* 9/2009 Tse ..... D14/209.1  
D620,921 S \* 8/2010 Skurdal ..... D14/209.1  
D636,759 S \* 4/2011 Chen ..... D14/214

(Continued)

FOREIGN PATENT DOCUMENTS

CN 202602868 \* 12/2012 ..... H04R 1/20

OTHER PUBLICATIONS

B&W T7 review, WhatHiFi.com, Feb. 19, 2015, [online], [site visited May 23, 2019]. URL: <https://www.whathifi.com/bw/t7/review> (Year: 2015).\*

(Continued)

*Primary Examiner* — T Chase Nelson  
*Assistant Examiner* — Jonathan J. Han

(57) **CLAIM**

The ornamental design for a portable loudspeaker, as shown and described.

**DESCRIPTION**

FIG. 1 is a front view of the portable loudspeaker; FIG. 2 is a left side view of the portable loudspeaker; FIG. 3 is a rear view of the portable loudspeaker; FIG. 4 is a right side view of the portable loudspeaker; FIG. 5 is a bottom view of the portable loudspeaker; FIG. 6 is a top view of the portable loudspeaker; FIG. 7 is a top right front perspective view of the portable loudspeaker; and, FIG. 8 is a top right rear perspective view of the portable loudspeaker.

**1 Claim, 2 Drawing Sheets**

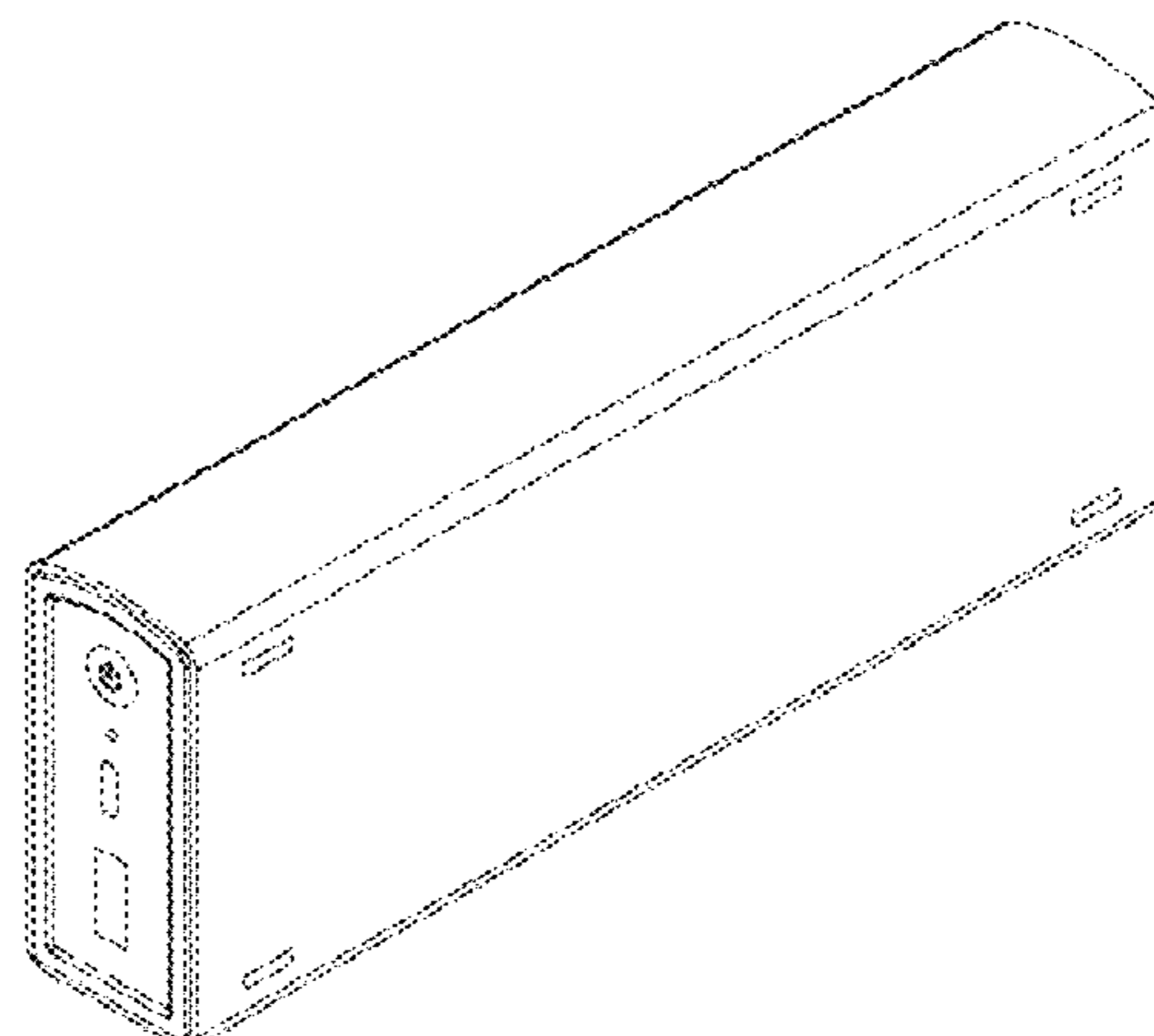
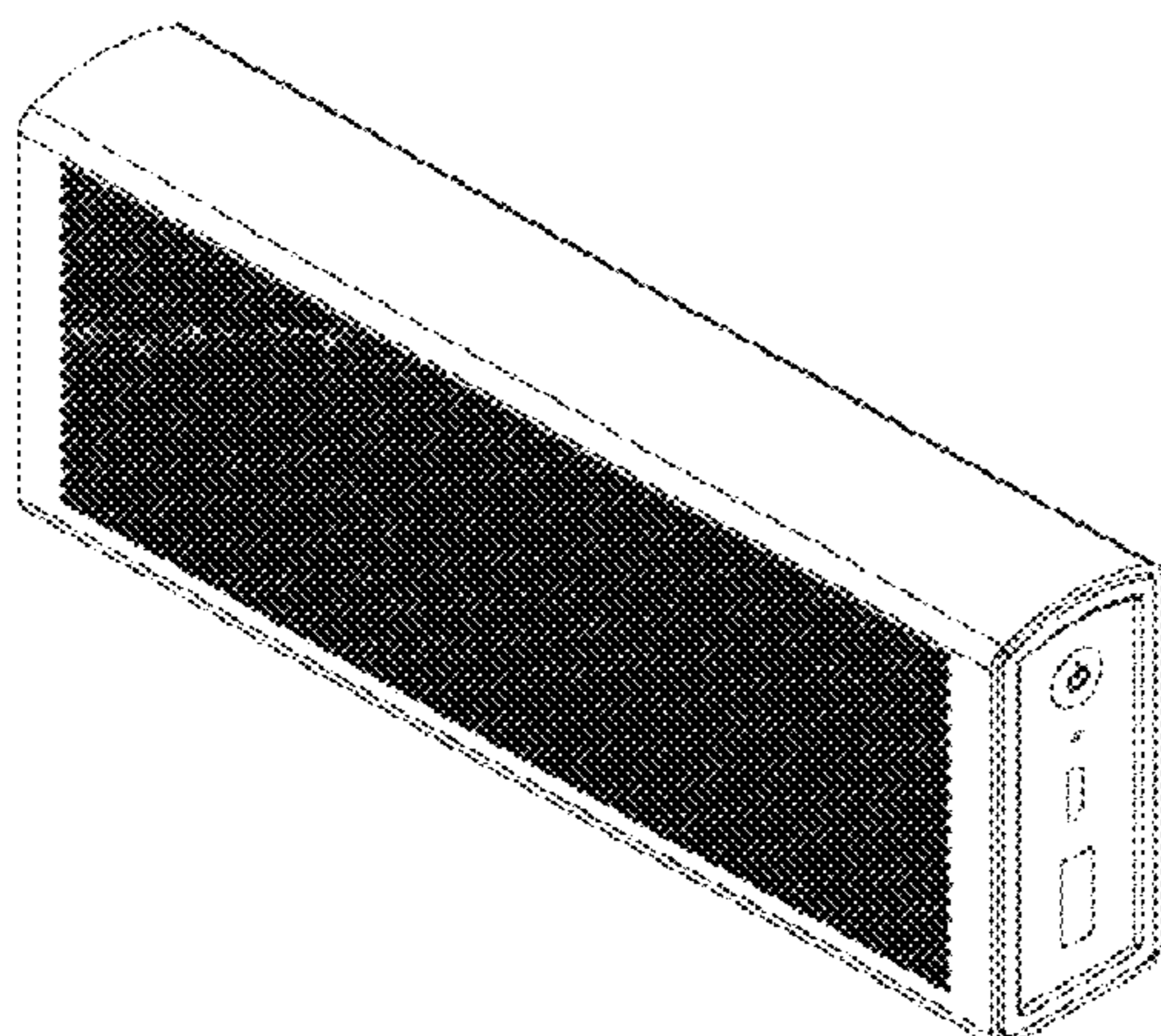

(56)

References Cited

U.S. PATENT DOCUMENTS

D647,505 S \* 10/2011 Skurdal ..... D14/209.1  
 D690,286 S \* 9/2013 Petersen ..... D14/209.1  
 D713,381 S \* 9/2014 Riggs ..... D14/214  
 D715,258 S \* 10/2014 Osborn ..... D14/212  
 D718,277 S \* 11/2014 Yamamoto ..... D14/214  
 D719,932 S \* 12/2014 Osborn ..... D14/214  
 D726,144 S \* 4/2015 Kang ..... D14/204  
 D730,319 S \* 5/2015 Behar ..... D14/214  
 D730,320 S \* 5/2015 Behar ..... D14/214  
 D730,321 S \* 5/2015 Behar ..... D14/214  
 D730,870 S \* 6/2015 Behar ..... D14/214  
 D731,462 S \* 6/2015 Behar ..... D14/214  
 D749,544 S \* 2/2016 Lee ..... D14/214  
 D763,823 S \* 8/2016 Holzer ..... D14/209.1  
 D766,875 S \* 9/2016 Holzer ..... D14/214  
 D806,679 S \* 1/2018 Demin ..... D14/214  
 D813,839 S \* 3/2018 Cheney ..... D14/214

D819,597 S \* 6/2018 Hu ..... D14/214  
 D826,854 S \* 8/2018 Roberts ..... D13/108  
 D848,419 S \* 5/2019 Jun ..... D14/356

OTHER PUBLICATIONS

Sony Bluetooth Wireless Speaker SRS-BTX300, PCmag.com, by Tim Gideon, Jul. 30, 2013 2:09PM EST, [online], [site visited May 23, 2019]. URL: <https://www.pcmag.com/review/313910/sony-bluetooth-wireless-speaker-srs-btx300> (Year: 2013).\*

DS3 Wireless Portable Speaker, Jamo.com, [online], [site visited May 23, 2019]. URL: <https://www.jamo.com/products/ds3> (Year: 2019).\*

Soundfreaq Pocket Kick Wireless Bluetooth Portable Speaker and Speakerphone (Black), Amazon.com, Date first listed on Amazon: Jun. 17, 2014, [online], [site visited May 23, 2019]. URL: [https://www.amazon.com/dp/B00L2MJF9C/ref=psdc\\_689637011\\_t3\\_B007XOQI4S](https://www.amazon.com/dp/B00L2MJF9C/ref=psdc_689637011_t3_B007XOQI4S) (Year: 2014).\*

\* cited by examiner

FIG.1

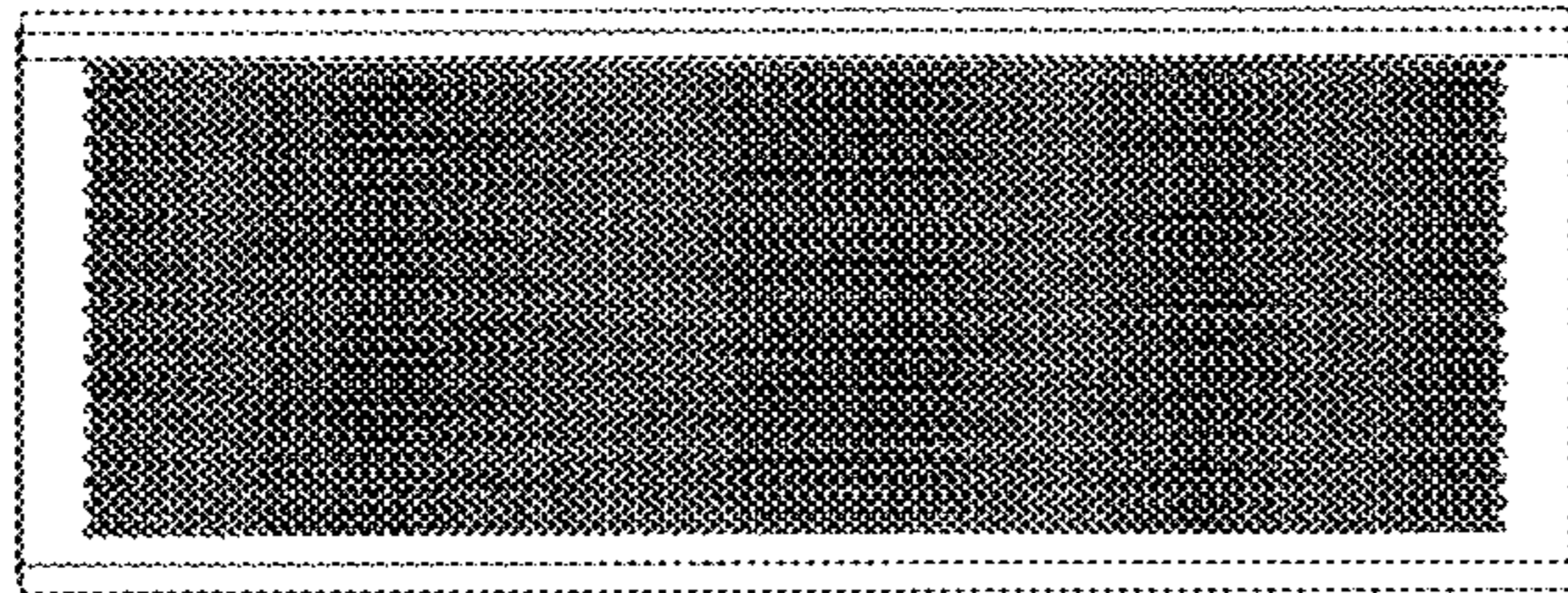

FIG.2

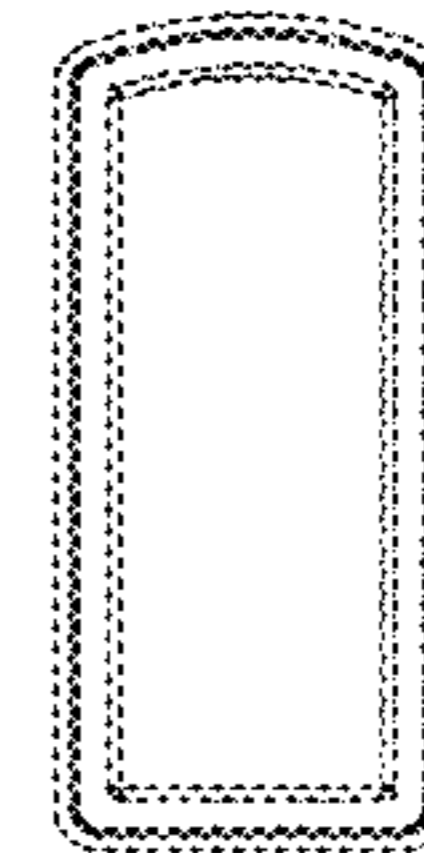

FIG.3

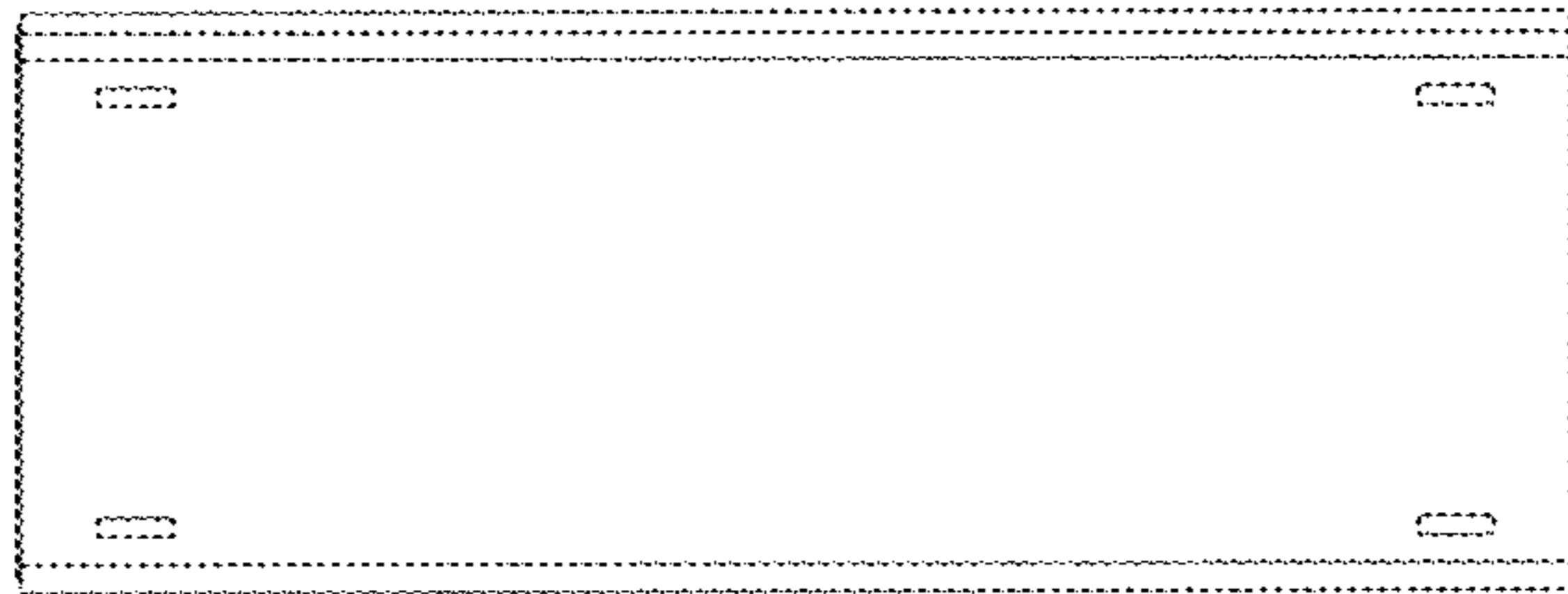

FIG.4

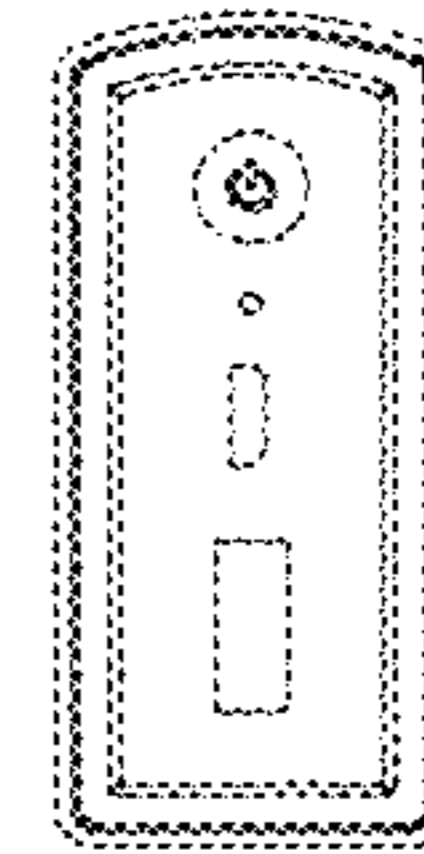

FIG.5

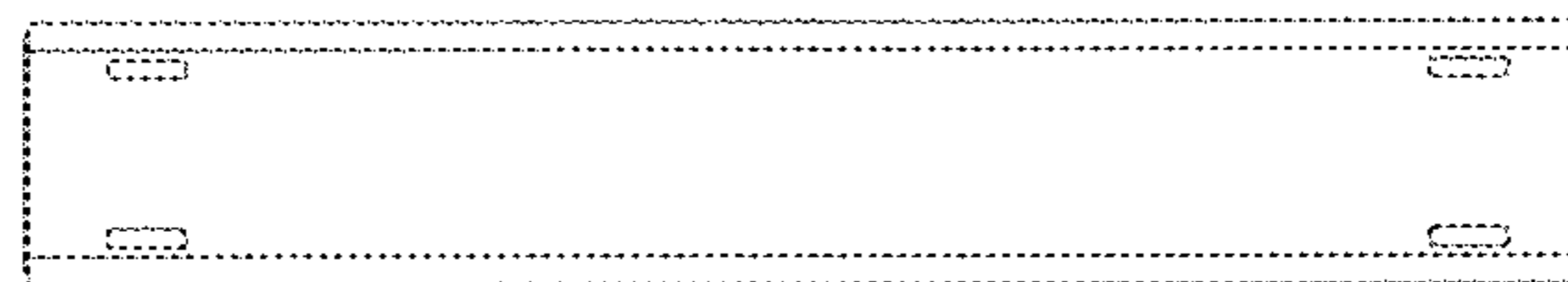

FIG.6

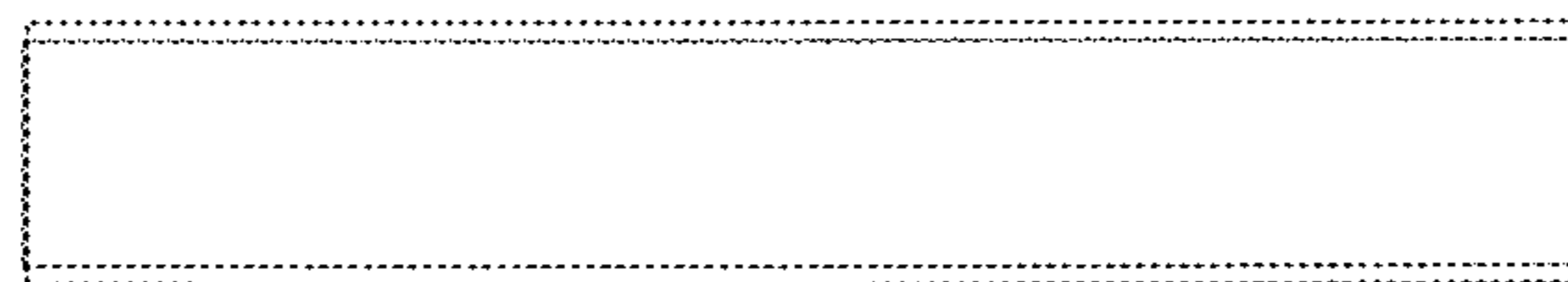

FIG.7

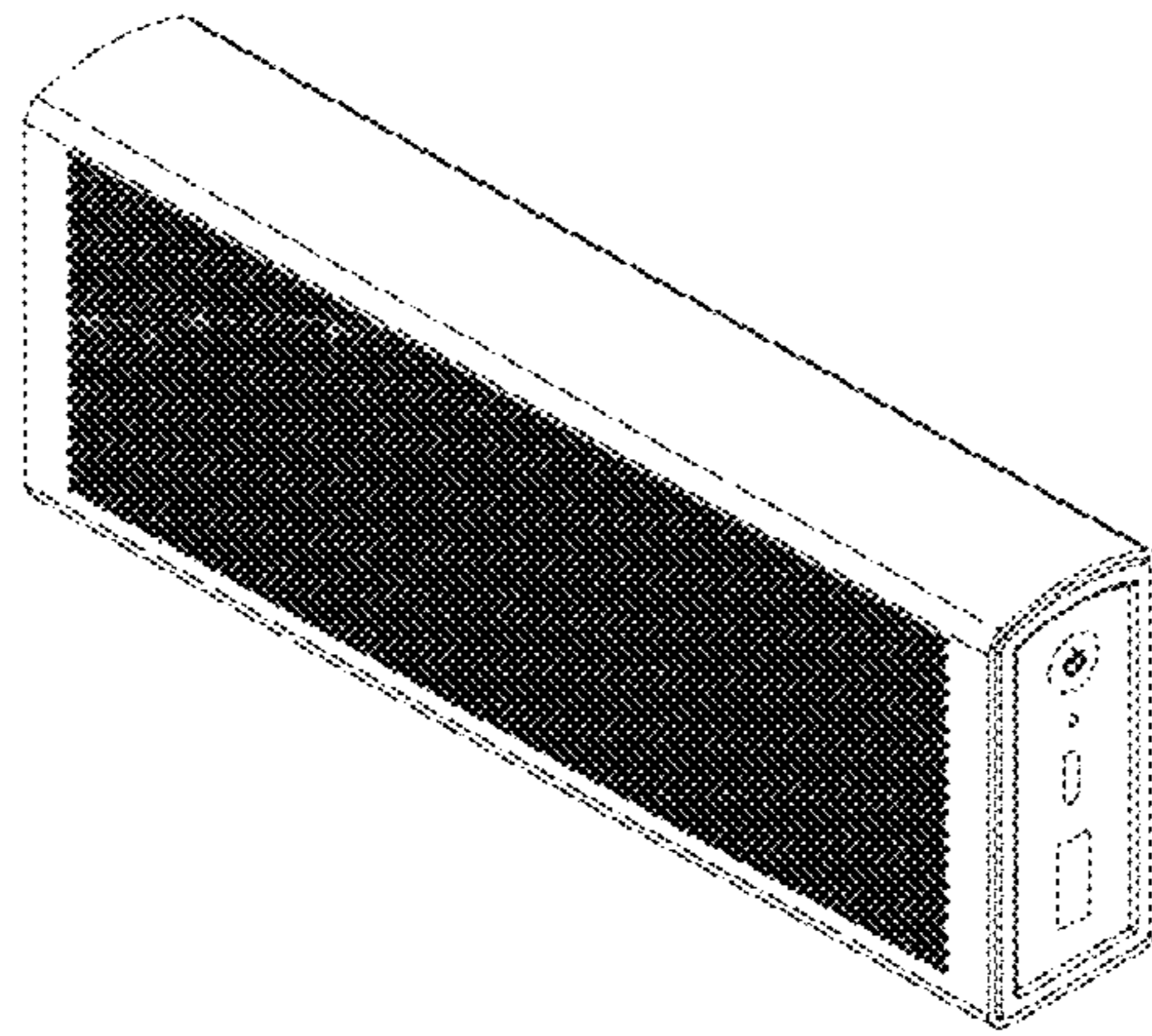

FIG.8

