

US00D864891S

(12) **United States Design Patent** (10) **Patent No.:** **US D864,891 S**
Yang (45) **Date of Patent:** **** Oct. 29, 2019**

(54) **GRAMOPHONE**

(71) Applicant: **1byone Products Inc.**, Ontario, CA (US)
(72) Inventor: **Ruishi Yang**, Ontario, CA (US)
(73) Assignee: **1BYONE PRODUCTS INC.**, Ontario, CA (US)
(**) Term: **15 Years**
(21) Appl. No.: **29/644,213**

(22) Filed: **Apr. 16, 2018**
(51) **LOC (12) Cl.** **14-01**
(52) **U.S. Cl.**
USPC **D14/202**
(58) **Field of Classification Search**
USPC D14/199-203, 261; 369/264-265;
312/8.1, 8.13
CPC B60R 11/02; B60K 37/04; B60K 37/06;
H04B 1/08; H04B 1/082; G11B 17/16;
G11B 23/00; G11B 19/16; G11B 33/02;
G11B 3/07
See application file for complete search history.

(56) **References Cited**

U.S. PATENT DOCUMENTS

1,811,628 A * 6/1931 Hollerith, Jr. G11B 33/02
312/8.15
D186,471 S * 10/1959 Steidinger D14/201
3,180,447 A * 4/1965 Huff G11B 33/02
D14/201
D265,085 S * 6/1982 Masterson G11B 33/02
D14/199
D268,028 S * 2/1983 Ekuan D14/202
D279,371 S * 6/1985 Arrington G11B 33/02
D14/202

OTHER PUBLICATIONS

Wanling Bluetooth gramophone, published Aug. 22, 2017. <https://sc01.alicdn.com/kf/HTB1NYf1QXXXXXayaXXXq6xXFXXM/CD-Jukebox-Modern-Phonograph-Vintage-Radio-AM.jpg>.*

* cited by examiner

Primary Examiner — Sandra L Morris
(74) *Attorney, Agent, or Firm* — Muncy, Geissler, Olds & Lowe, P.C.

(57) **CLAIM**

The ornamental design for a gramophone, as shown and described.

DESCRIPTION

FIG. 1 is a front, top, left perspective view of a gramophone showing my new design;
FIG. 2 is a front top, right perspective view thereof;
FIG. 3 is a front, top, right perspective view thereof, with the lid shown in an alternate, closed position;
FIG. 4 is a rear, top, left perspective view thereof, with the lid shown in an alternate, closed position;
FIG. 5 is a front elevational view thereof;
FIG. 6 is a rear elevational view thereof;
FIG. 7 is a left side elevational view thereof;
FIG. 8 is a right side elevational view thereof;
FIG. 9 is a top plan view thereof; and,
FIG. 10 is a bottom plan view thereof.
The broken lines show portions of the gramophone which form no part of the claimed design.

1 Claim, 10 Drawing Sheets

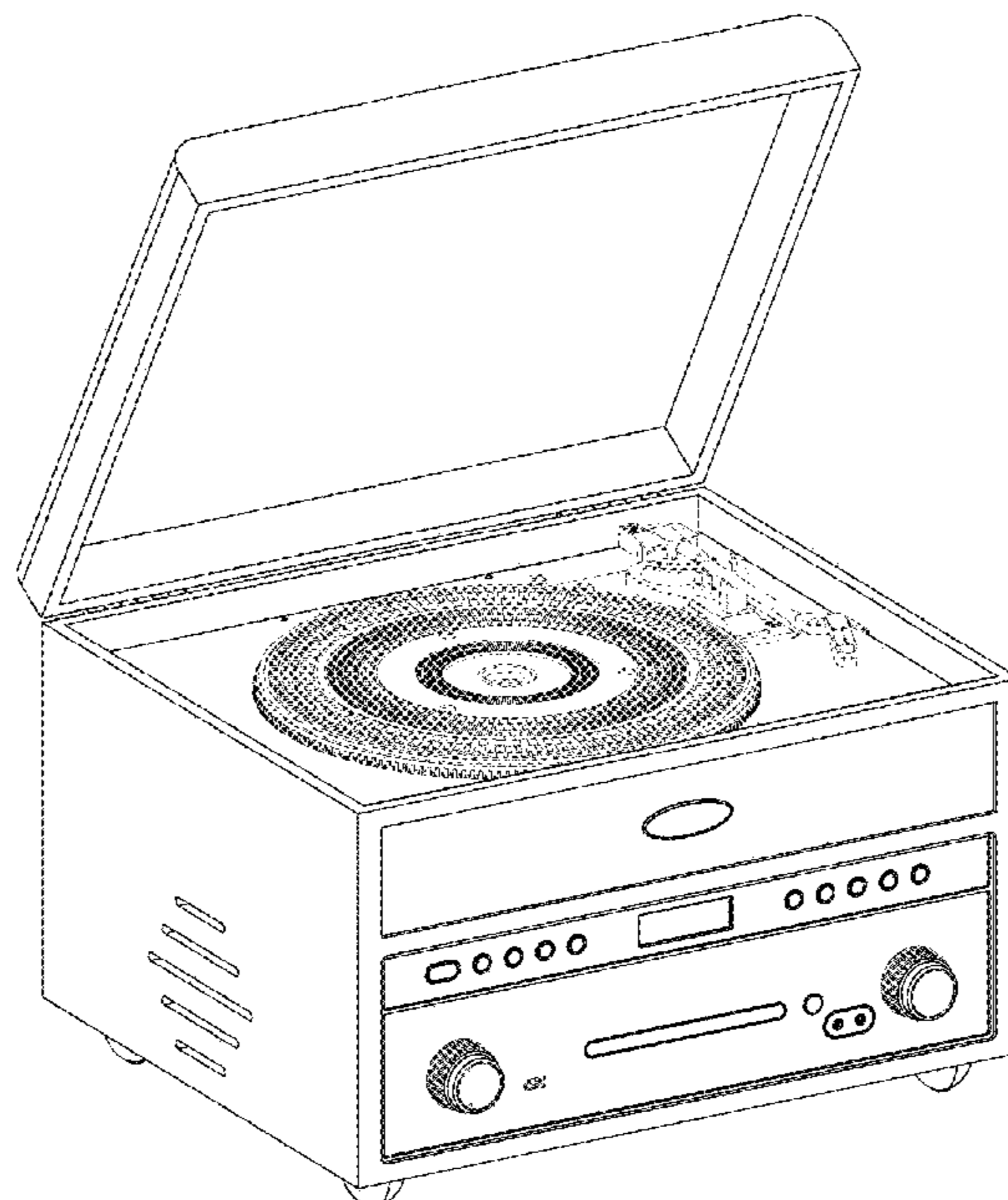

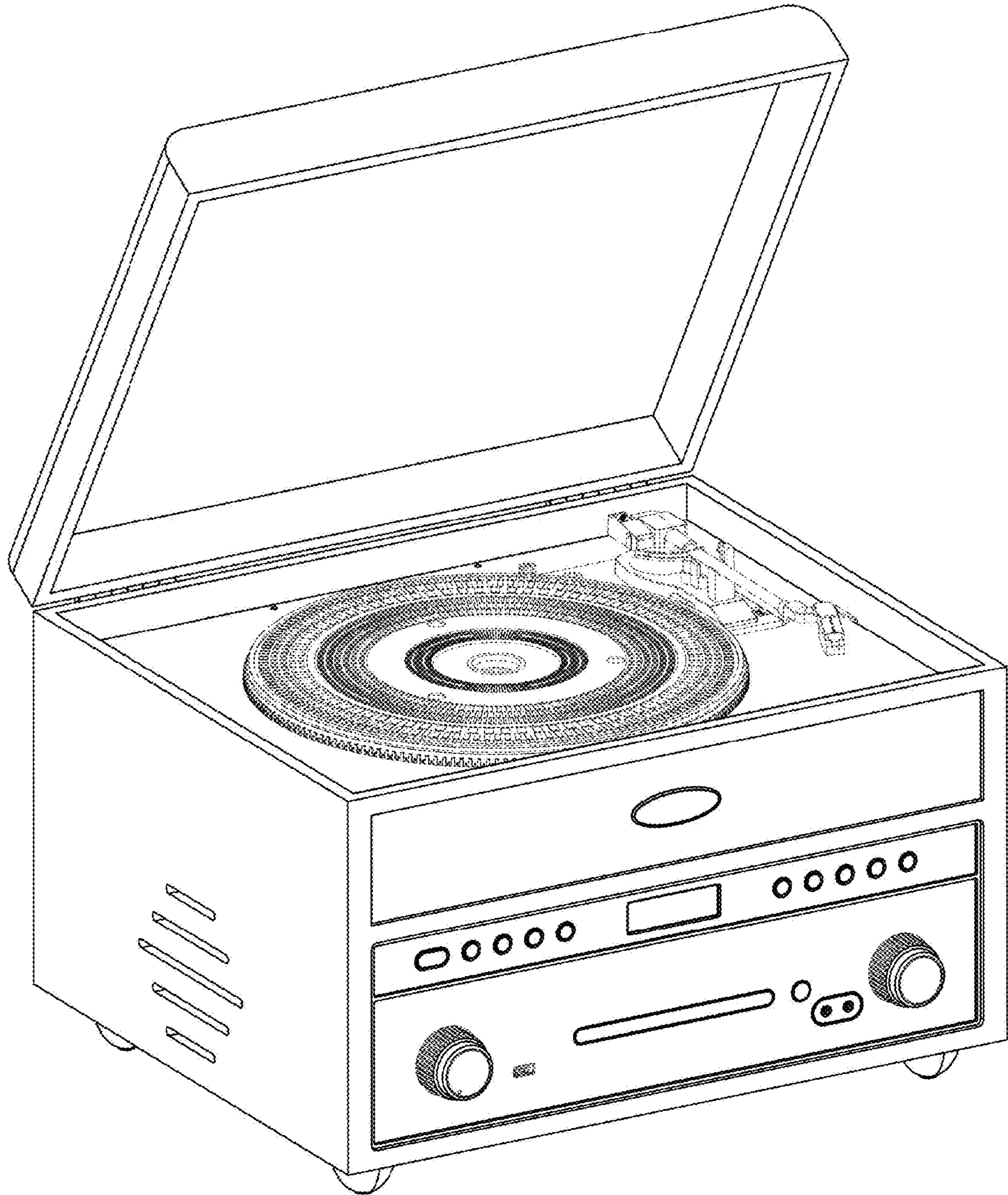

FIG. 1

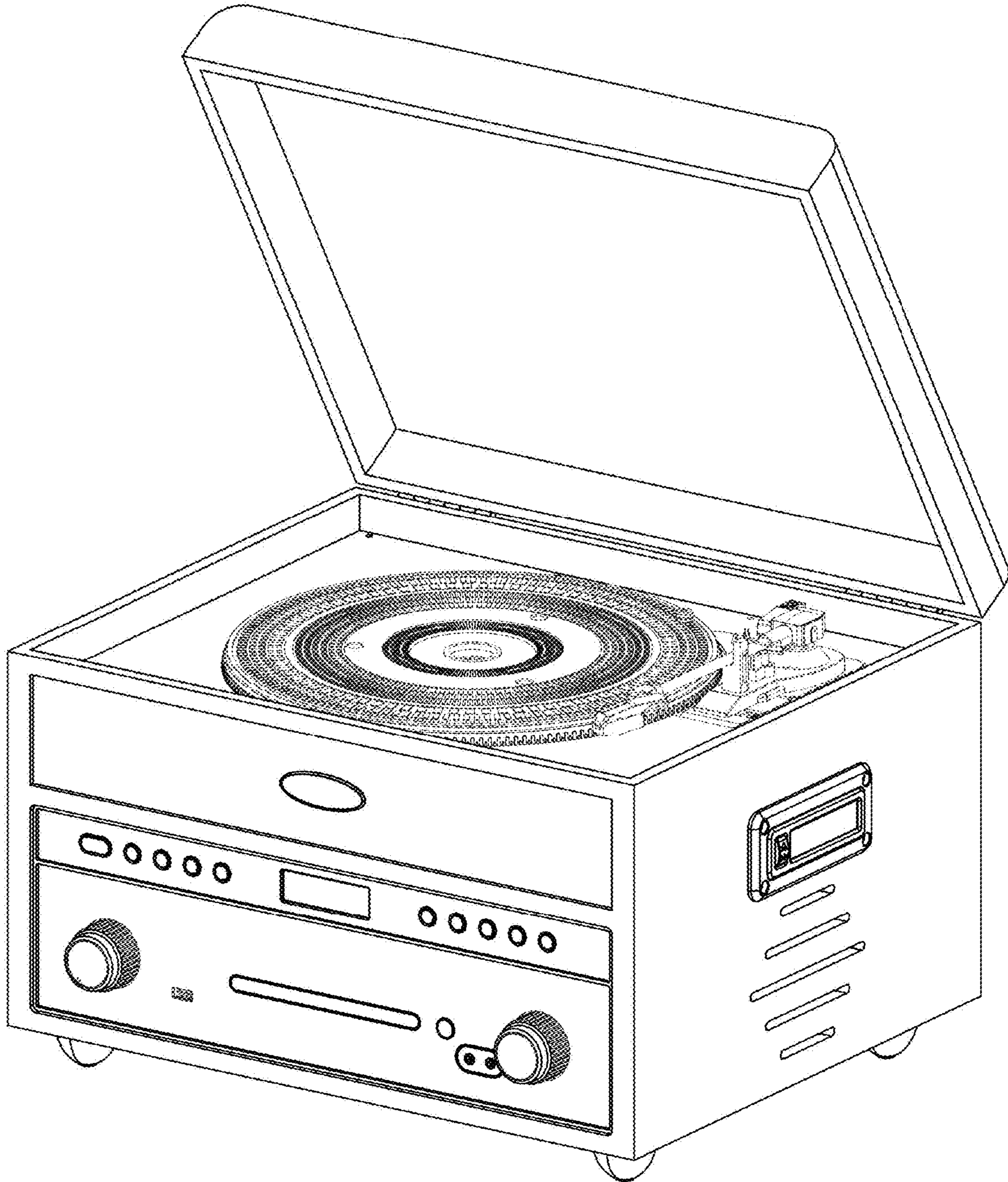

FIG. 2

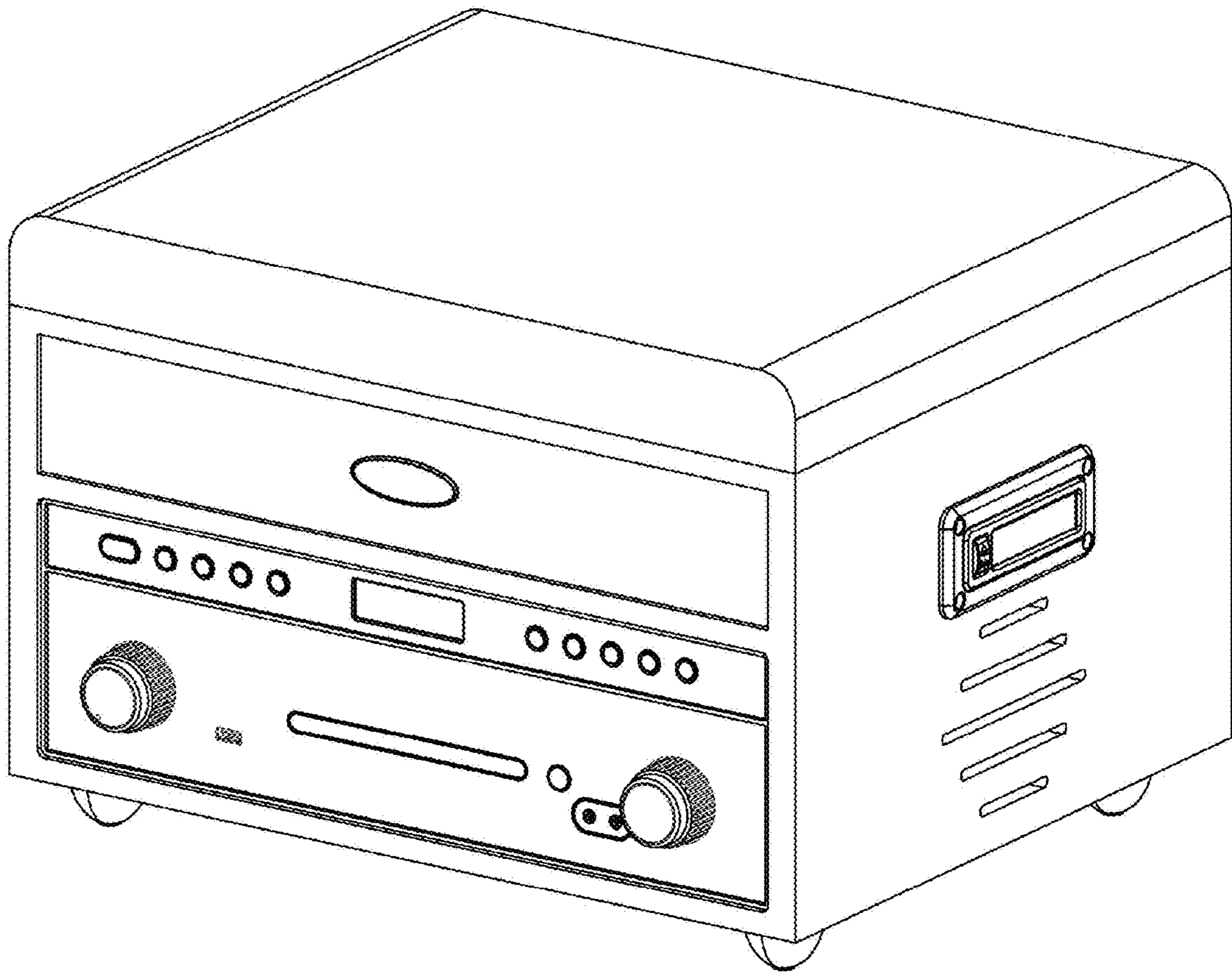

FIG. 3

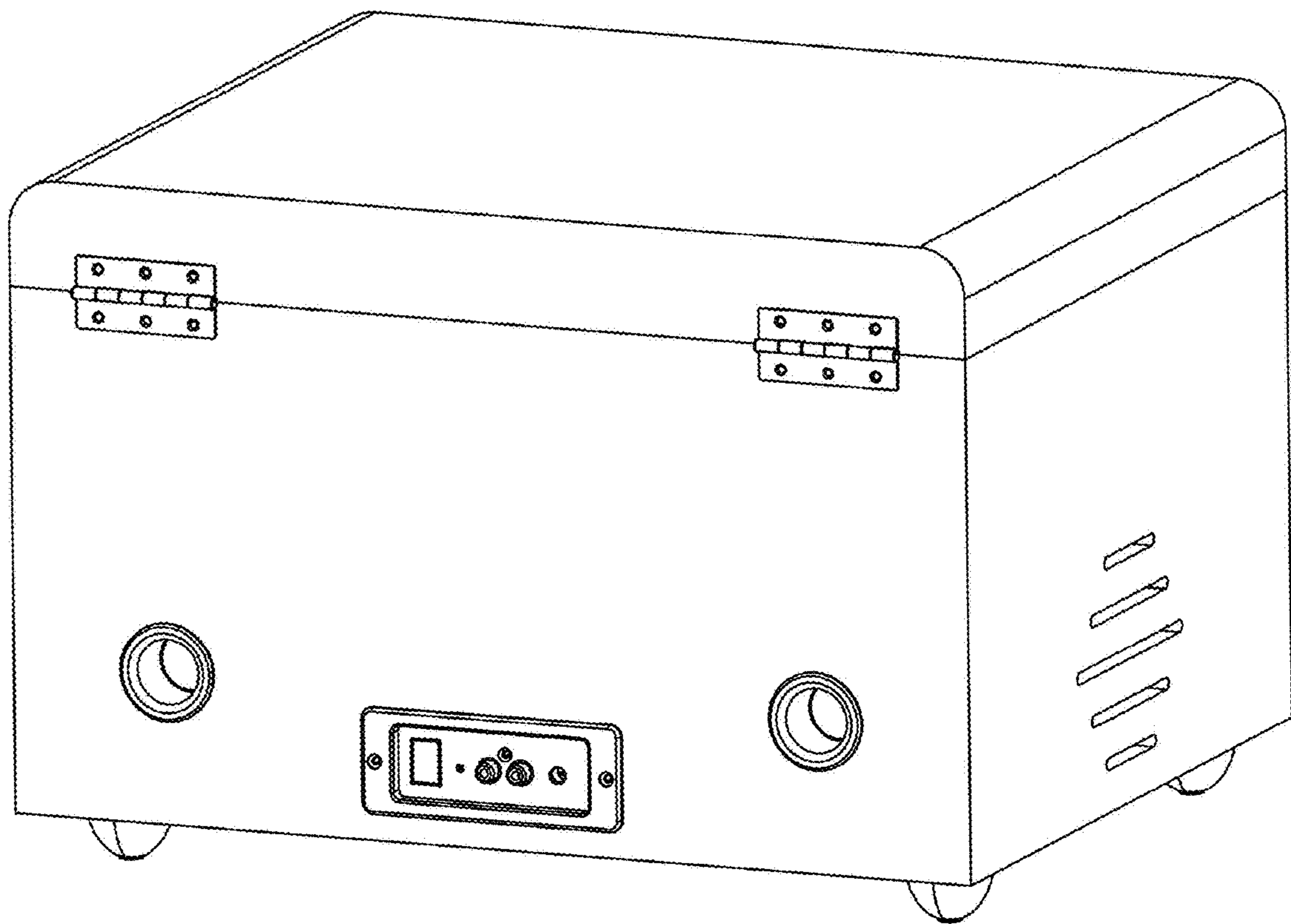

FIG. 4

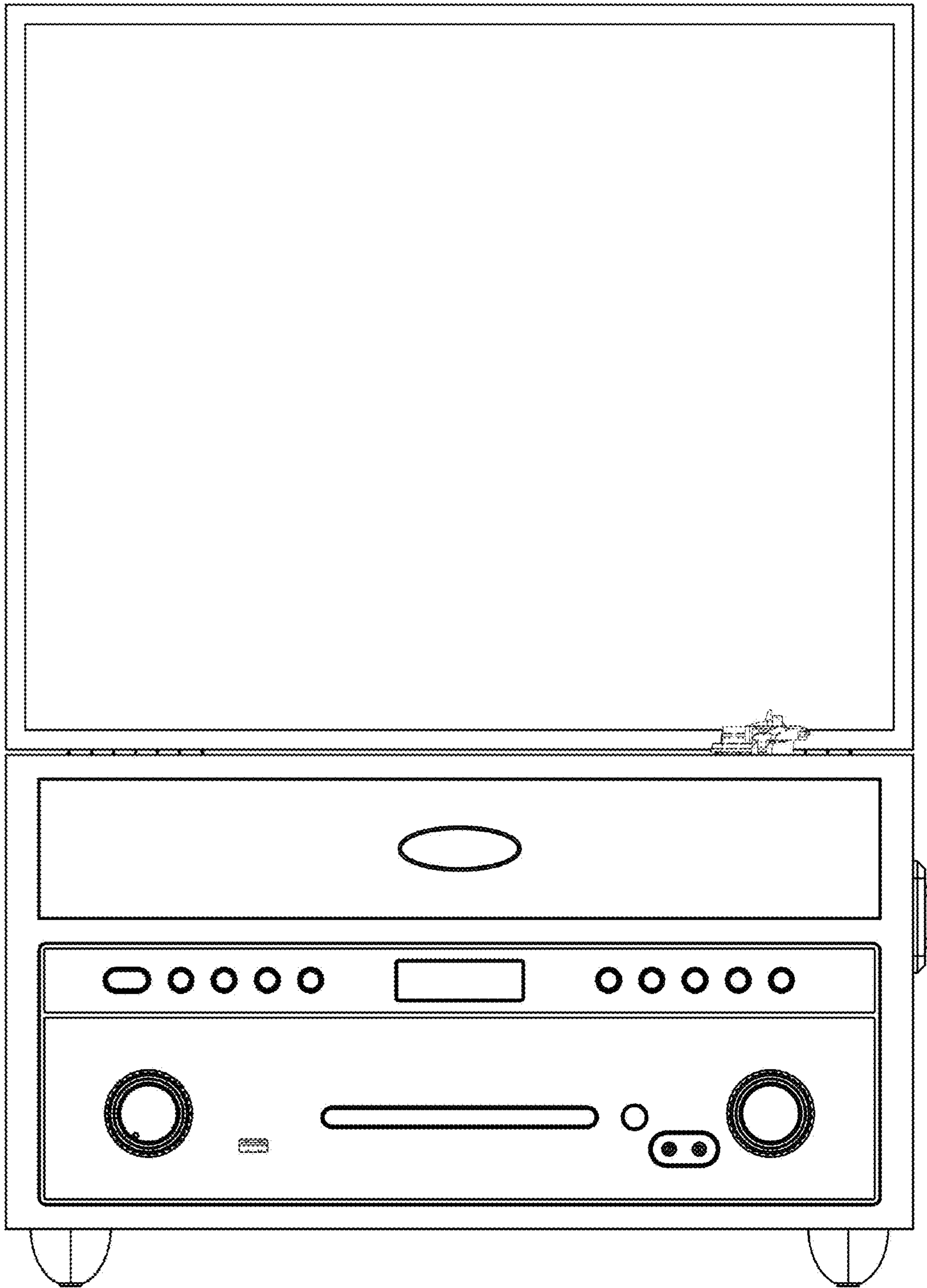

FIG. 5

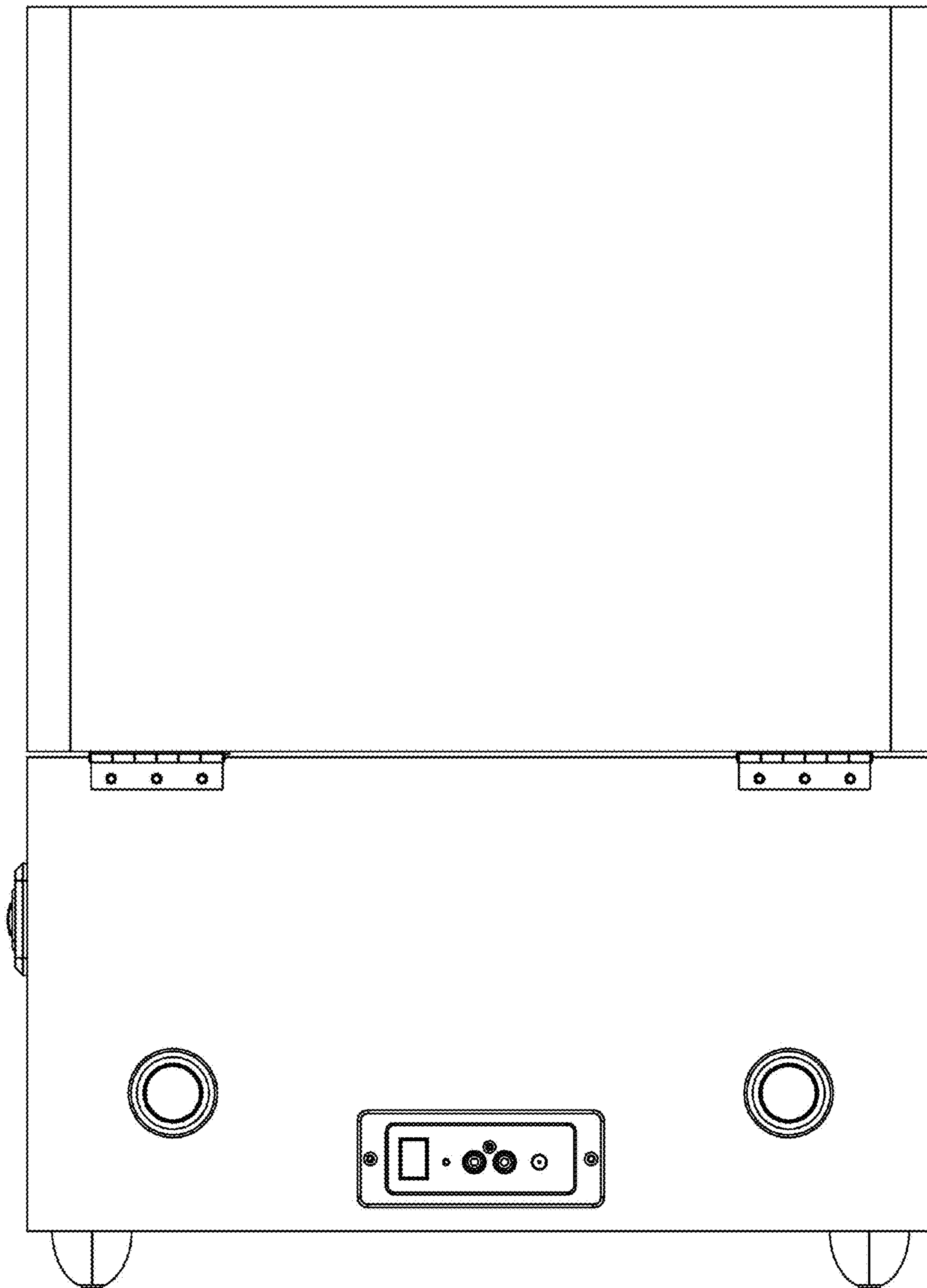

FIG. 6

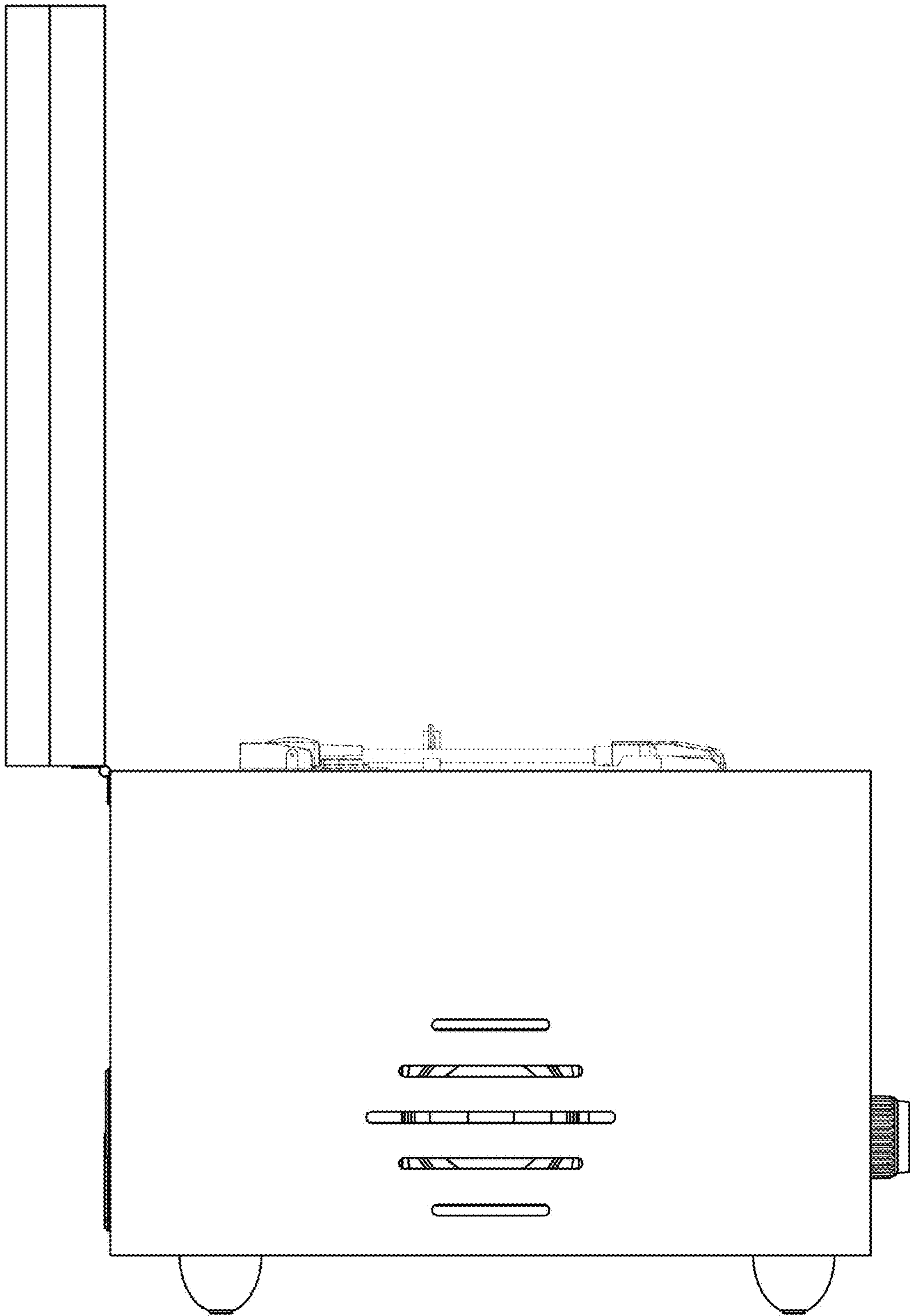

FIG. 7

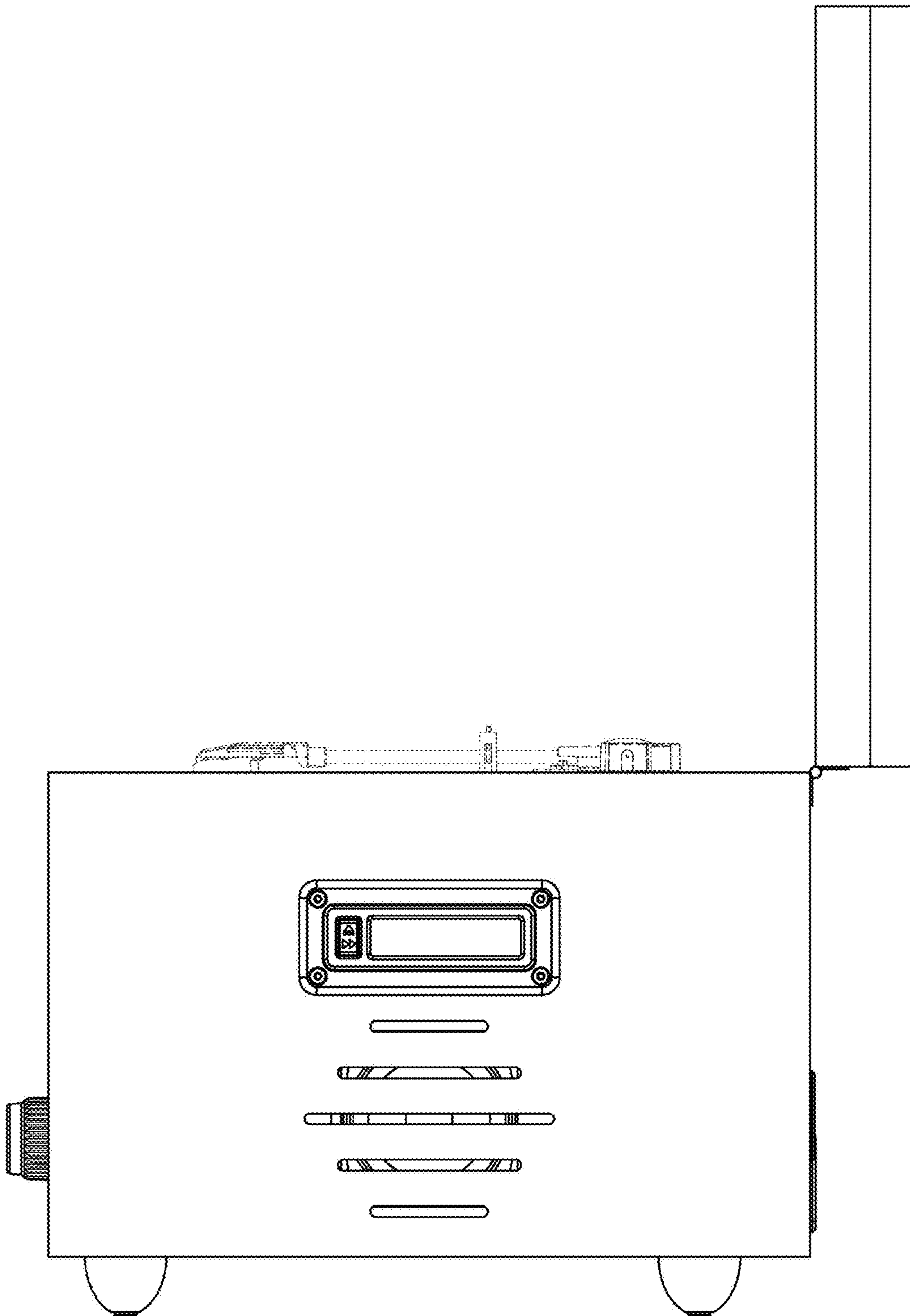

FIG. 8

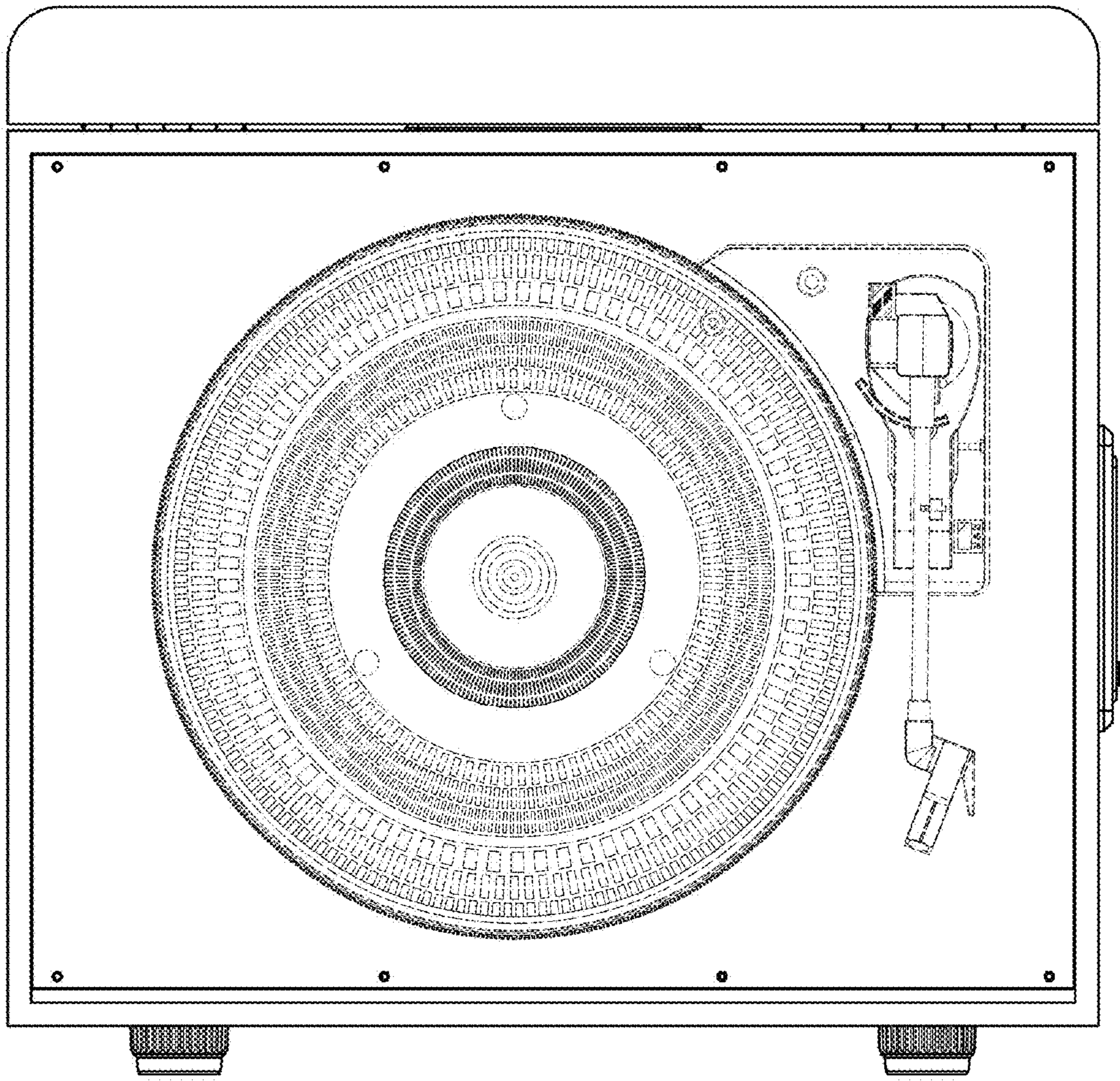

FIG. 9

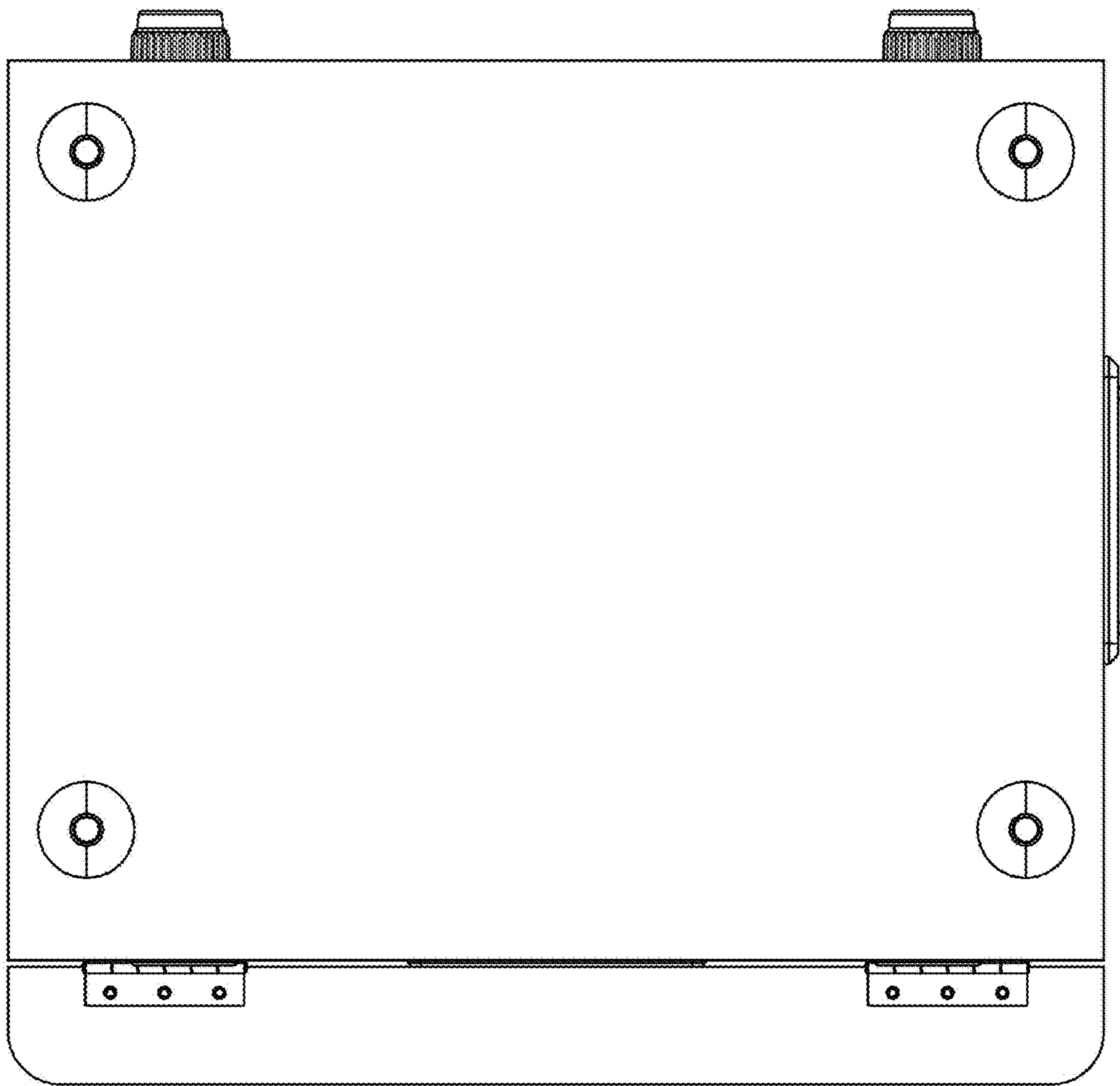

FIG. 10