

US00D864862S

(12) **United States Design Patent** (10) **Patent No.:** **US D864,862 S**
Cheng (45) **Date of Patent:** **** Oct. 29, 2019**

(54) **PORTABLE POWER BANK**
(71) Applicant: **QEE Technology (Shenzhen) Co., Ltd.**, Shenzhen (CN)
(72) Inventor: **Kin Chung Cheng**, Shenzhen (CN)
(73) Assignee: **QEE Technology (Shenzhen) Co., Ltd.**, Shenzhen (CN)
(**) Term: **15 Years**
(21) Appl. No.: **29/644,155**
(22) Filed: **Apr. 16, 2018**

(30) **Foreign Application Priority Data**
Oct. 17, 2017 (AU) 201716310
(51) **LOC (12) Cl.** **13-02**
(52) **U.S. Cl.**
USPC **D13/108**; D13/103
(58) **Field of Classification Search**
USPC D13/102-110, 139.8, 118-119, 184, 199;
D14/356, 432
CPC Y02E 60/10; Y02E 60/12; Y02E 60/122;
Y02E 60/124; Y02E 60/50; H01M 2/02;
H01M 2/022; H01M 2/0202; H01M
2/0207; H01M 2/0212; H01M 2/1061;
H01M 2/1022; H01M 2/1055; H01M
2/1066; H01M 2/105; H01M 2/20; H01M
2/204; H01M 2/206; H01M 10/44; H01M
10/46; H01M 10/465; H01M 10/482;
H01M 2200/30; H01M 2250/30; H01M
2250/40; H02J 7/00; H02J 7/0003; H02J
7/0011; H02J 7/0013; H02J 7/0054; H02J
7/0055; H02J 7/0057; H02J 2007/0062
See application file for complete search history.

(56) **References Cited**
U.S. PATENT DOCUMENTS
D531,343 S * 10/2006 Chen D26/104
D614,608 S * 4/2010 Behling D14/223
D632,643 S * 2/2011 Tanaka D13/103
D641,338 S * 7/2011 Chen D14/209.1
D718,335 S * 11/2014 Lee D14/203.1
D749,506 S * 2/2016 Morgan D13/108
D753,332 S * 4/2016 De Bevilacqua D26/106
D780,113 S * 2/2017 Xianxi D13/103
D800,652 S * 10/2017 Yang D13/107
D841,574 S * 2/2019 Ma D13/103
D851,039 S * 6/2019 Schumacher D13/110
D853,361 S * 7/2019 Ding D14/225
2018/0241022 A1 * 8/2018 Nishihara B62M 6/90
* cited by examiner

Primary Examiner — Rosemary K Tarcza
Assistant Examiner — Nathaniel D. Buckner

(57) **CLAIM**
The ornamental design for a portable power bank, as shown and described.

DESCRIPTION
FIG. 1 is a top left perspective view of the portable power bank showing my new design;
FIG. 2 is bottom right perspective view thereof;
FIG. 3 is a front elevational view thereof;
FIG. 4 is a rear elevational view thereof;
FIG. 5 is a left side elevational view thereof;
FIG. 6 is a right side elevational view thereof;
FIG. 7 is a top plan view thereof; and,
FIG. 8 is a bottom plan view thereof.
The broken lines shown in the drawings depict portions of the portable power bank which form no part of the claimed design.

1 Claim, 8 Drawing Sheets

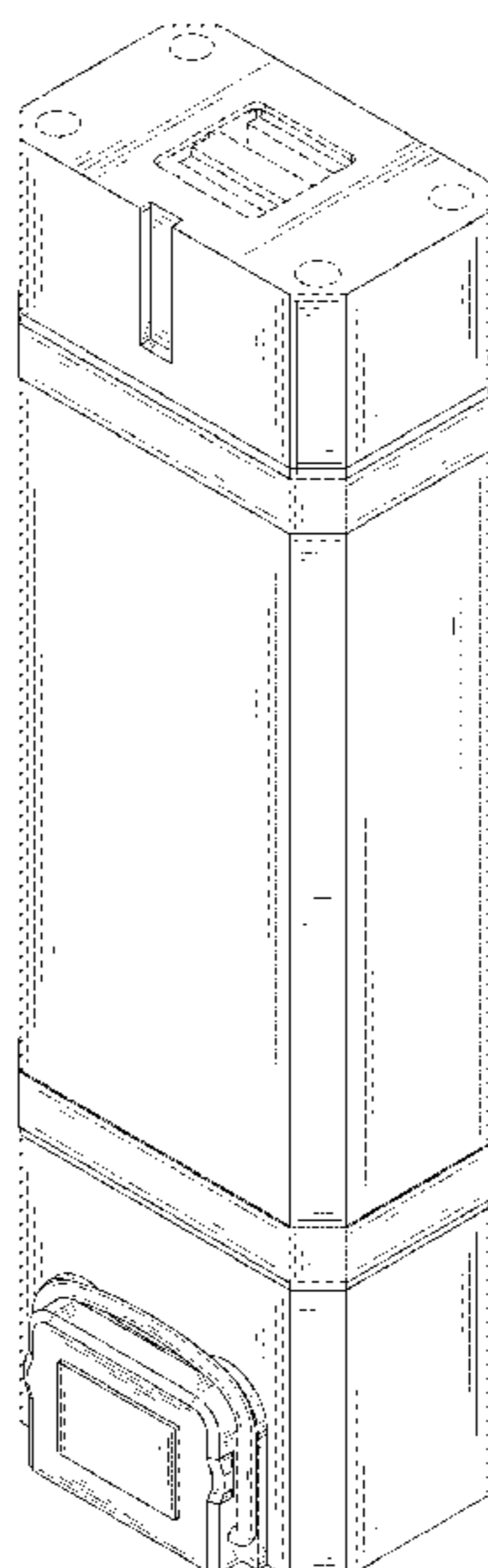

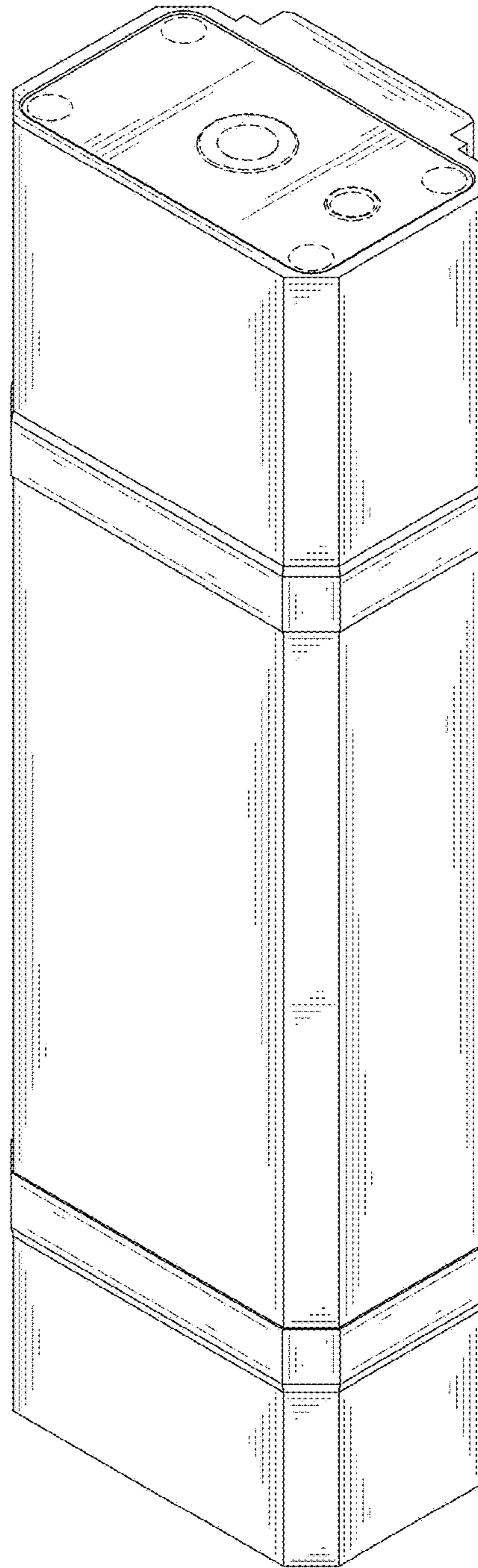

FIG. 1

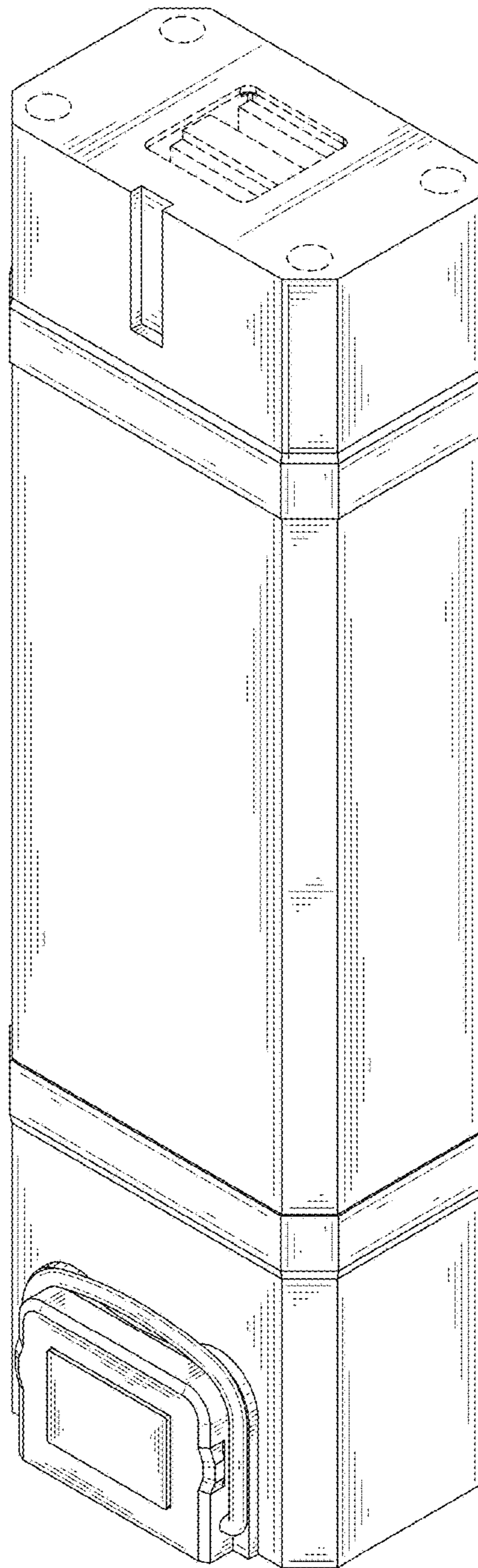

FIG. 2

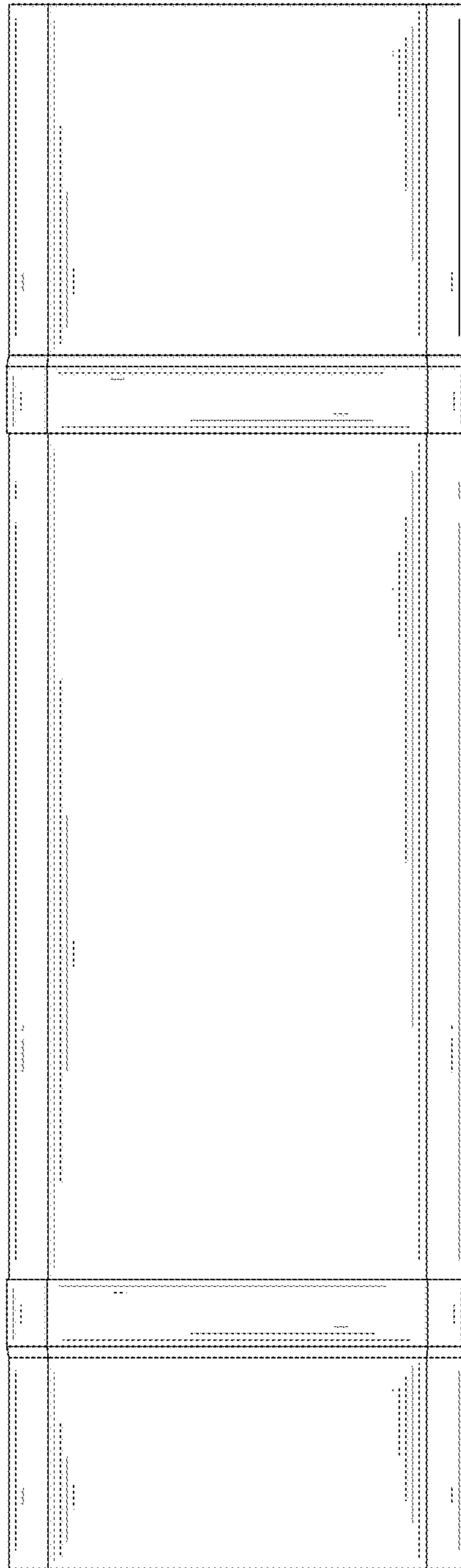

FIG. 3

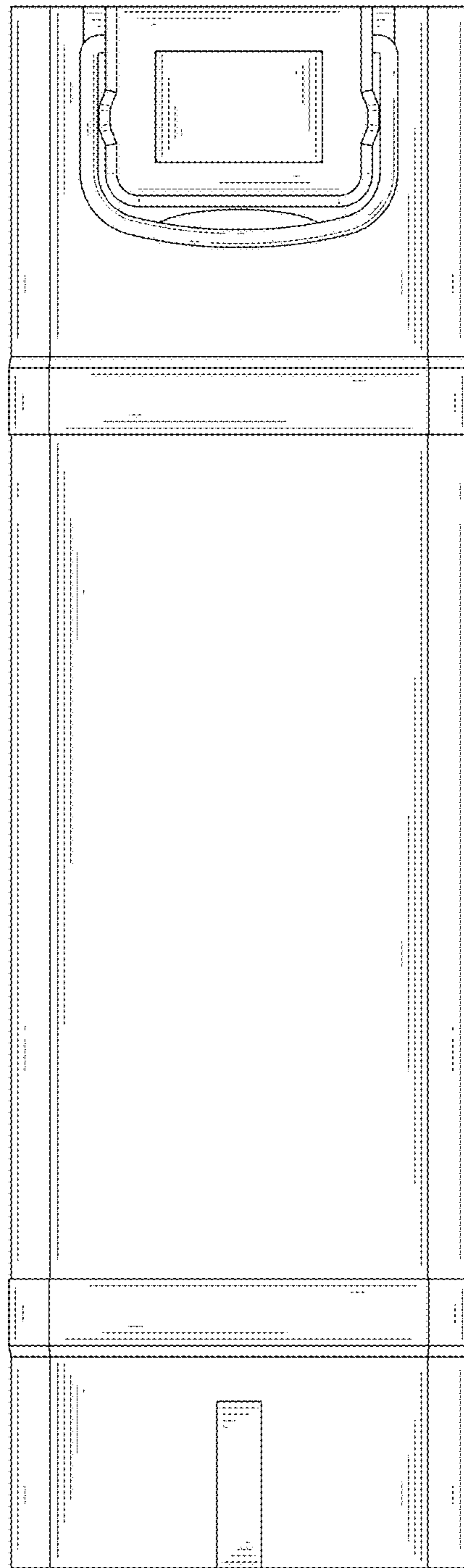

FIG. 4

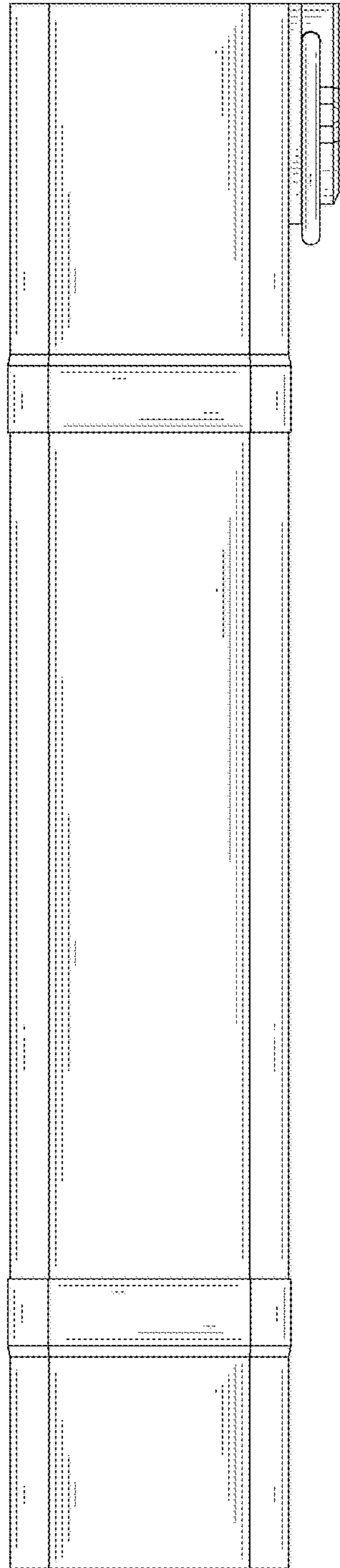

FIG. 5

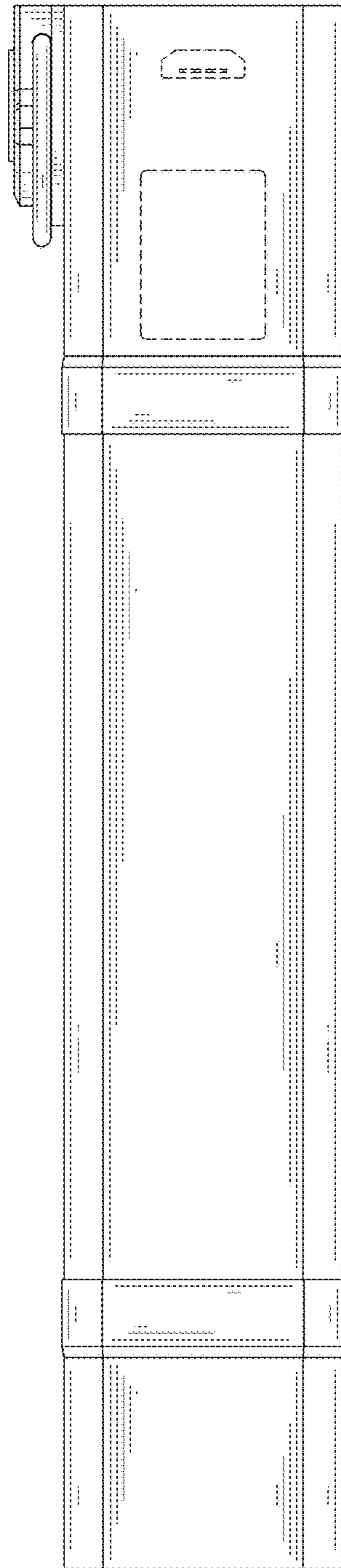

FIG. 6

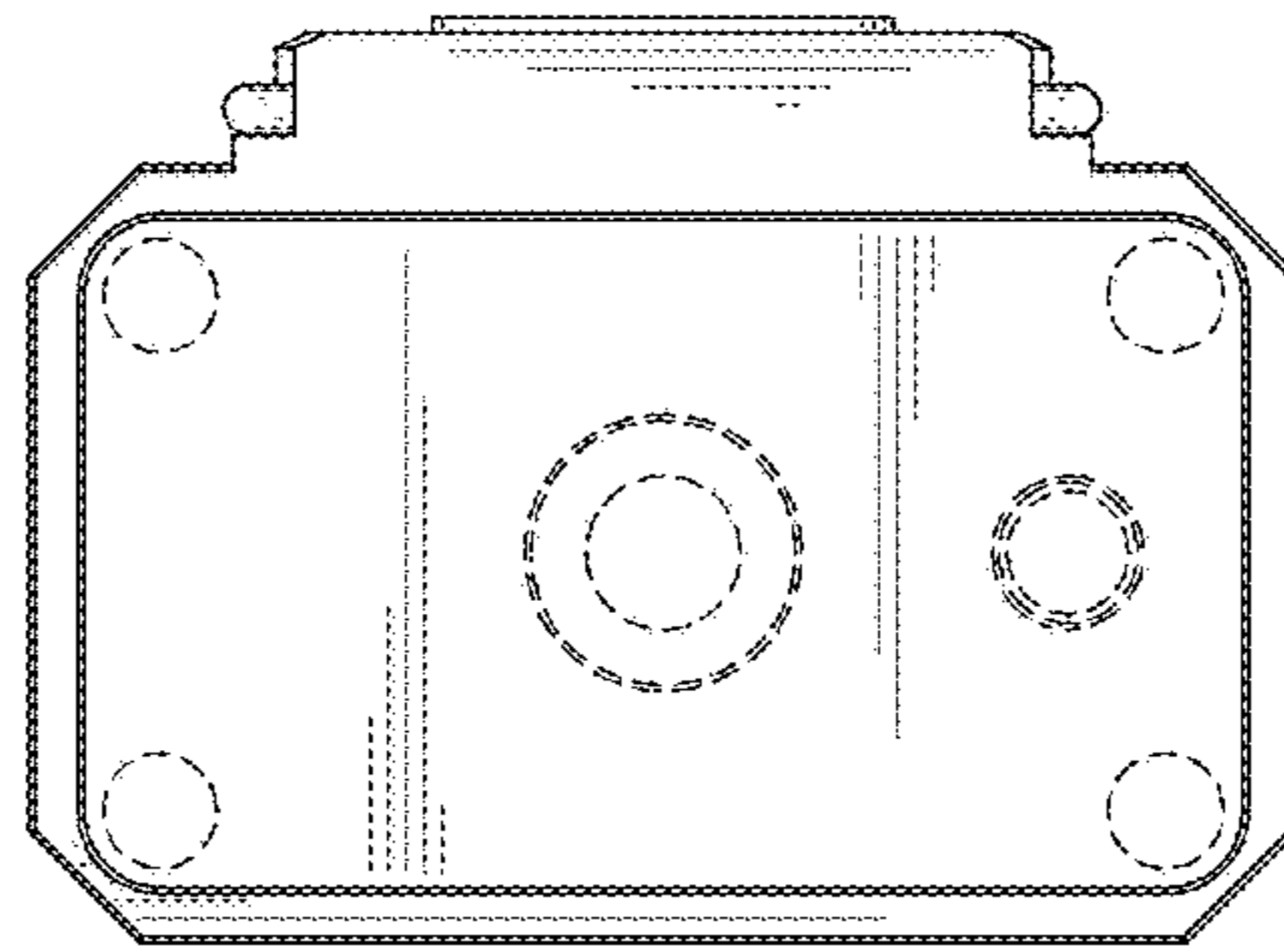

FIG. 7

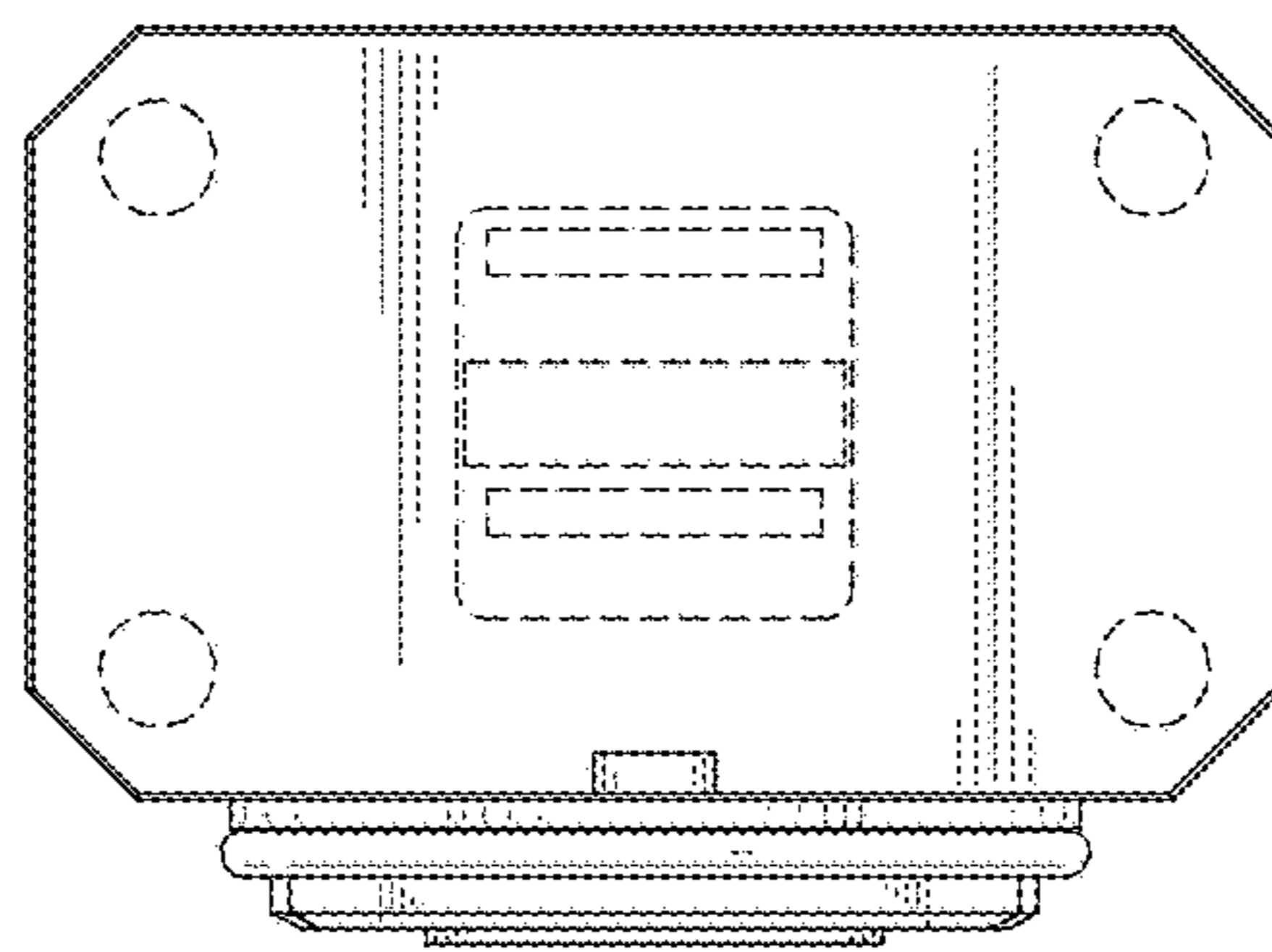

FIG. 8