

US00D864647S

(12) **United States Design Patent** (10) **Patent No.:** **US D864,647 S**
Larsen et al. (45) **Date of Patent:** **** Oct. 29, 2019**

(54) **TEAPOT WITH LID**
(71) Applicant: **Fiskars Finland Oy Ab**, Helsinki (FI)
(72) Inventors: **Lars Holme Larsen**, Copenhagen (DK); **Bjark Ingels**, København V (DK); **Jens Martin Skibsted**, Holte (DK)
(73) Assignee: **Fiskars Finland Oy Ab**, Helsinki (FI)
(**) Term: **15 Years**
(21) Appl. No.: **29/632,123**
(22) Filed: **Jan. 5, 2018**
(51) **LOC (12) Cl.** **07-01**
(52) **U.S. Cl.**
USPC **D7/319; D7/316**
(58) **Field of Classification Search**
USPC D7/312, 316, 318, 319, 320, 321, 322;
99/323
CPC A47J 31/14; A47J 27/21191; A47G 19/14
See application file for complete search history.

D539,590 S * 4/2007 Henderson D7/312
D541,574 S * 5/2007 Henderson D7/312
D560,091 S * 1/2008 Bodum D7/312
D566,455 S * 4/2008 Bodum D7/312
D604,555 S * 11/2009 Jensen D7/300
D621,267 S * 8/2010 Arnell D9/516
D793,148 S * 8/2017 Beckman D7/319
D805,815 S * 12/2017 Leonorovitz D6/667
2015/0069093 A1* 3/2015 Chen A47G 19/14
222/469

* cited by examiner
Primary Examiner — Marianne N Pandozzi
(74) *Attorney, Agent, or Firm* — Leason Ellis LLP

(57) **CLAIM**

I claim, the ornamental design for a teapot with lid, as shown and described.

DESCRIPTION

FIG. 1 is a perspective view of a teapot with lid, showing my new design;
FIG. 2 is a side view thereof;
FIG. 3 is a side view thereof, opposite to that shown in FIG. 2;
FIG. 4 is a top view thereof;
FIG. 5 is a bottom view thereof;
FIG. 6 is a rear view thereof; and,
FIG. 7 is a front view thereof.

1 Claim, 6 Drawing Sheets

(56) **References Cited**
U.S. PATENT DOCUMENTS
2,889,080 A * 6/1959 Livingstone A47G 19/145
222/109
D337,486 S * 7/1993 Maggiore D21/599
D418,715 S * 1/2000 Huang D7/312
D524,590 S * 7/2006 Bodum D7/312

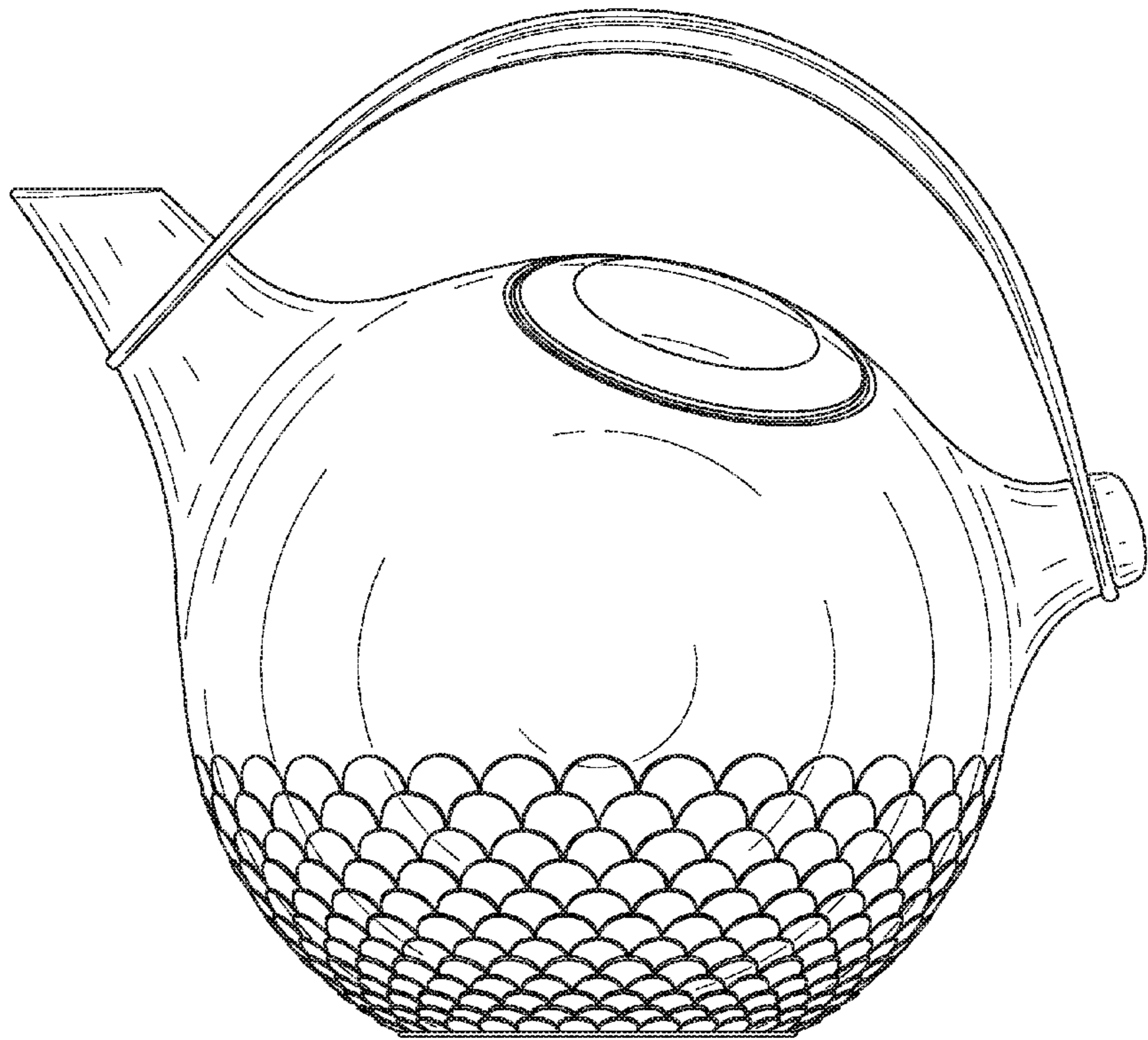

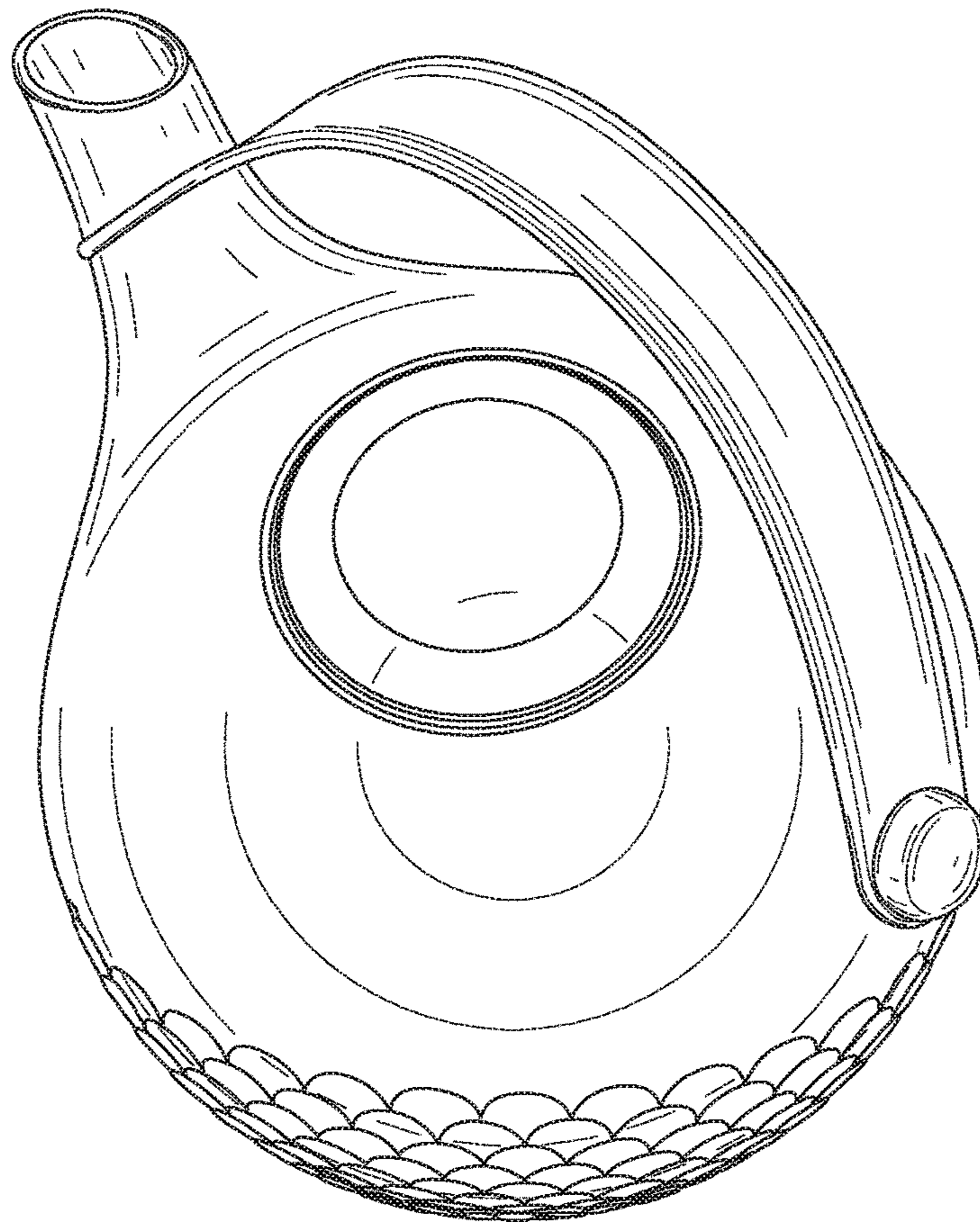

FIG. 1

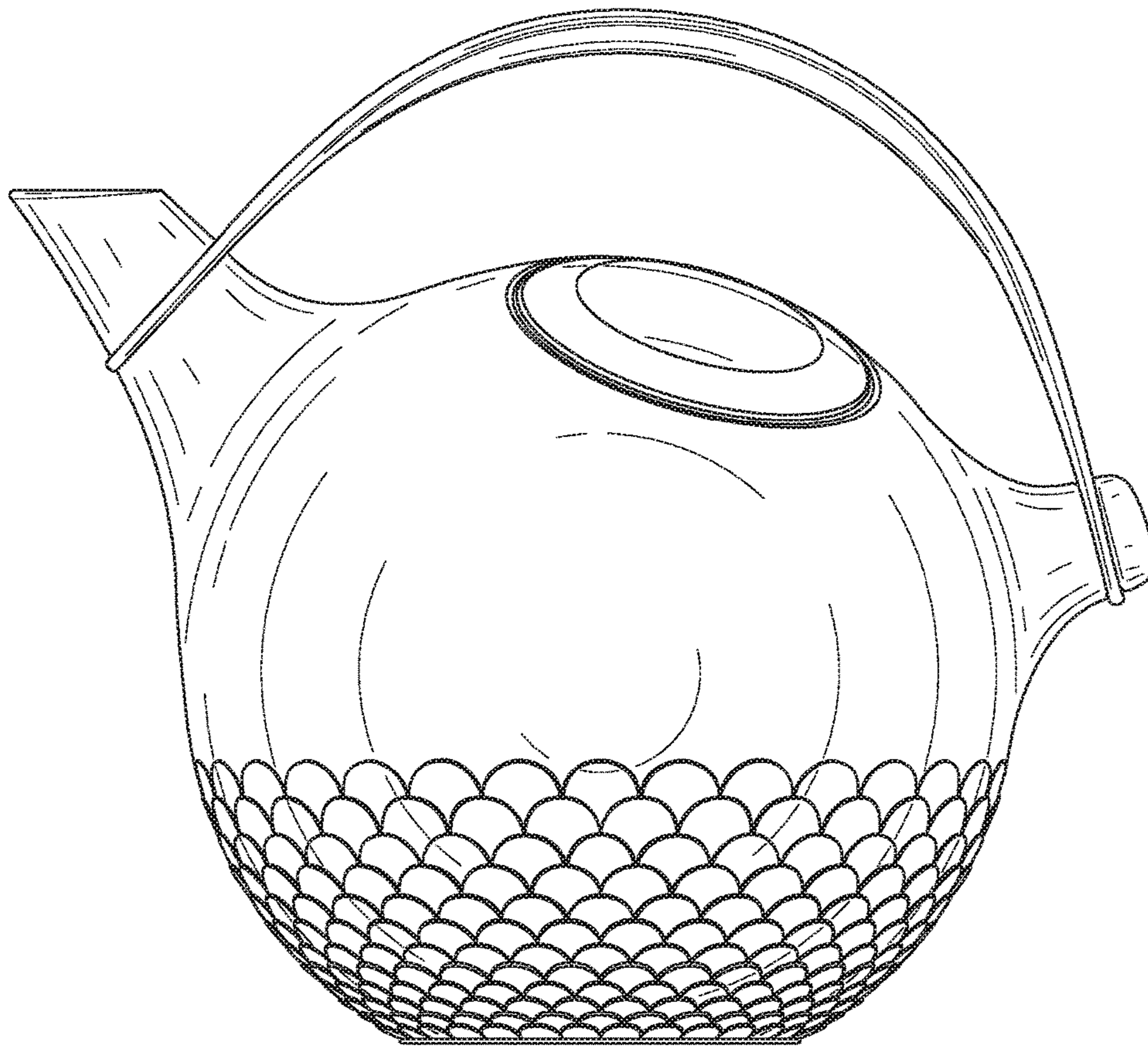

FIG. 2

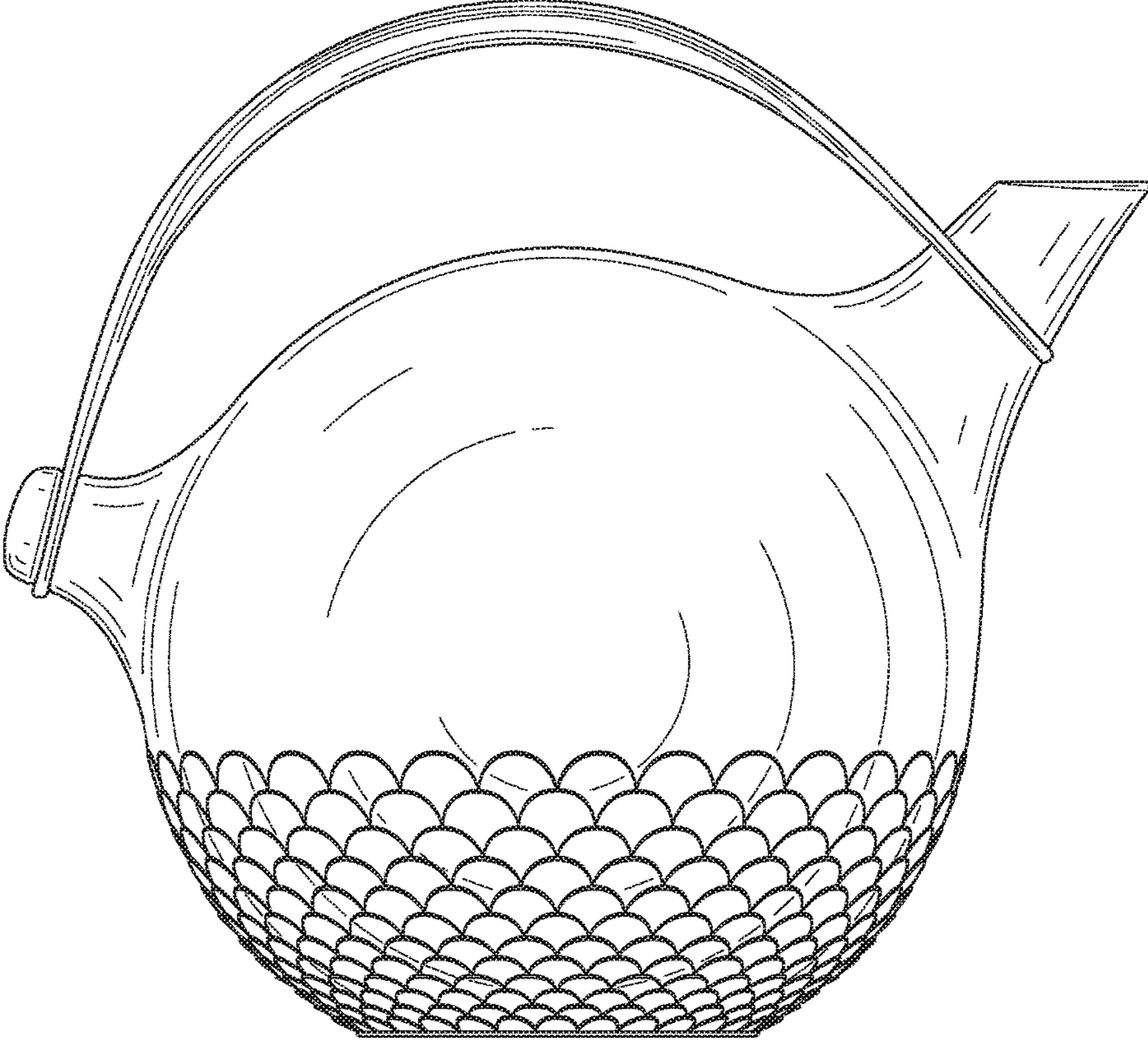

FIG. 3

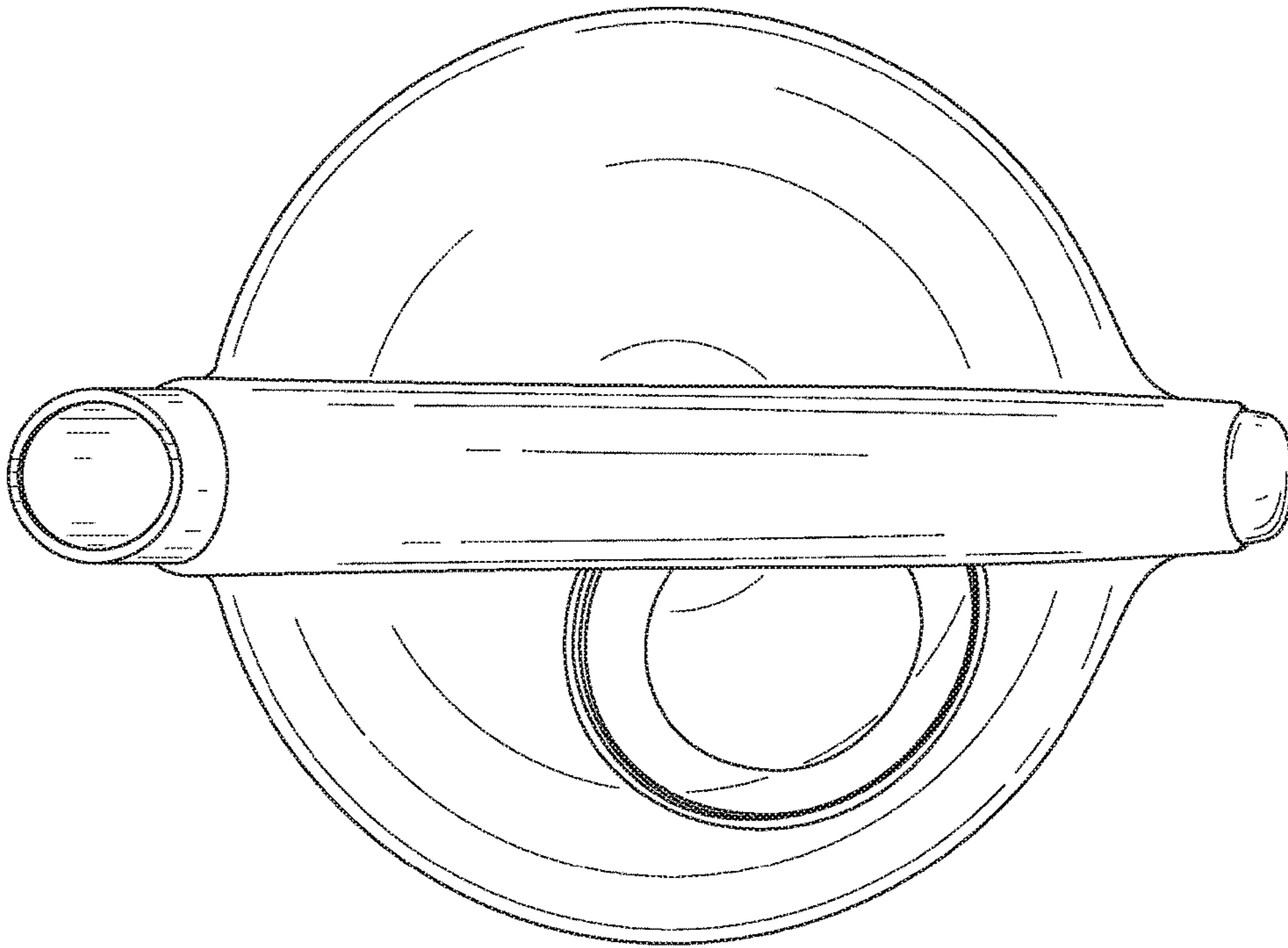

FIG. 4

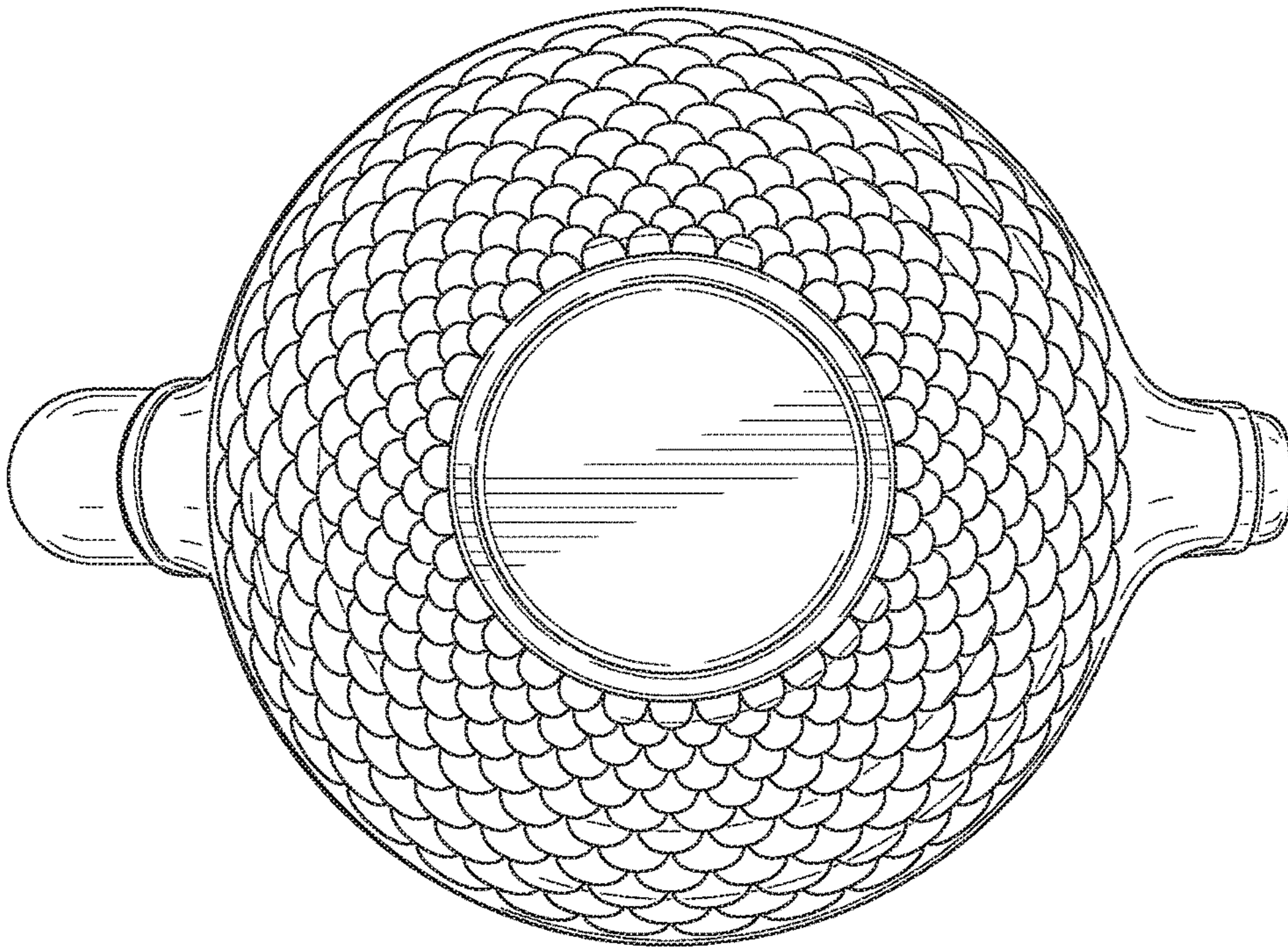

FIG. 5

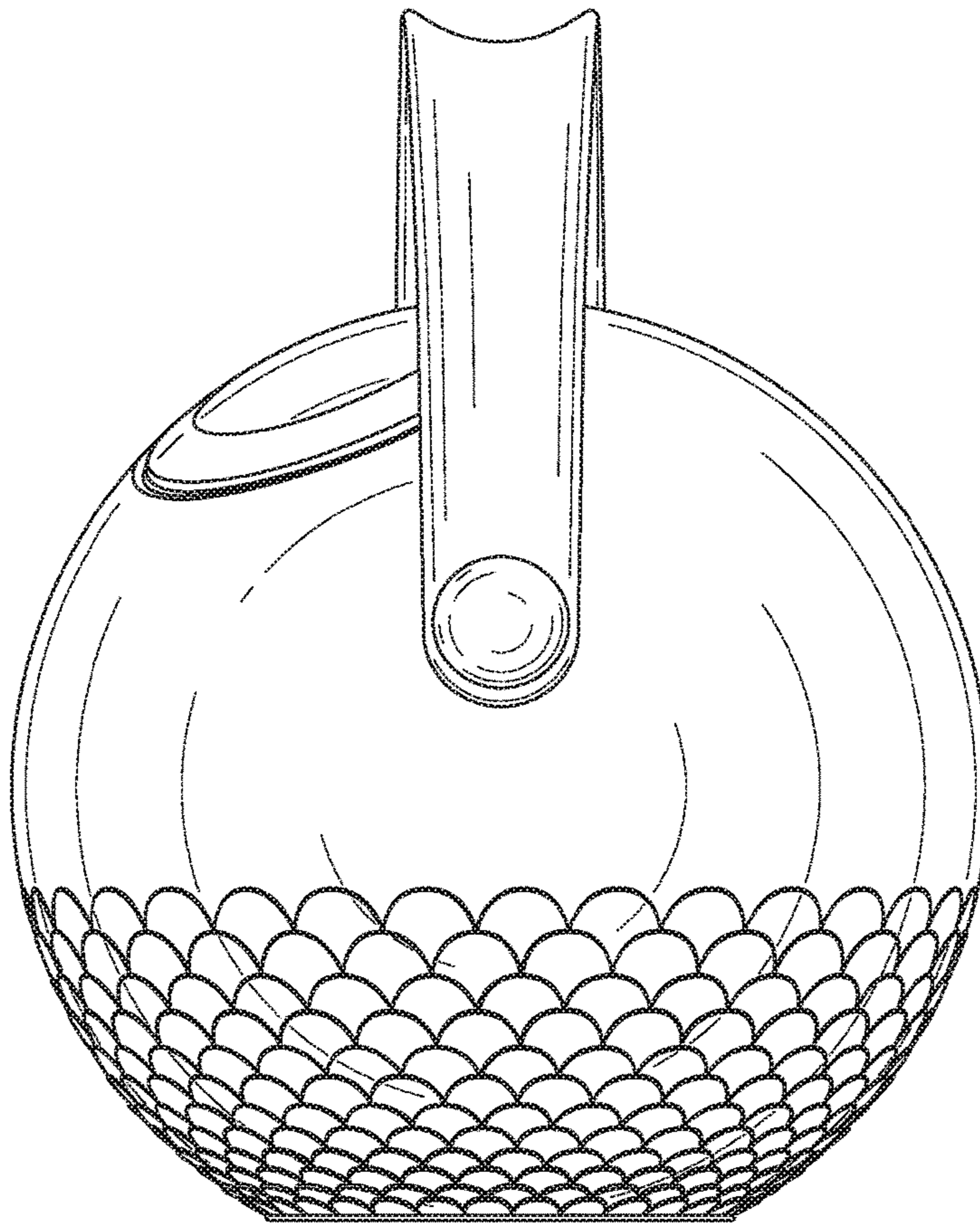

FIG. 6

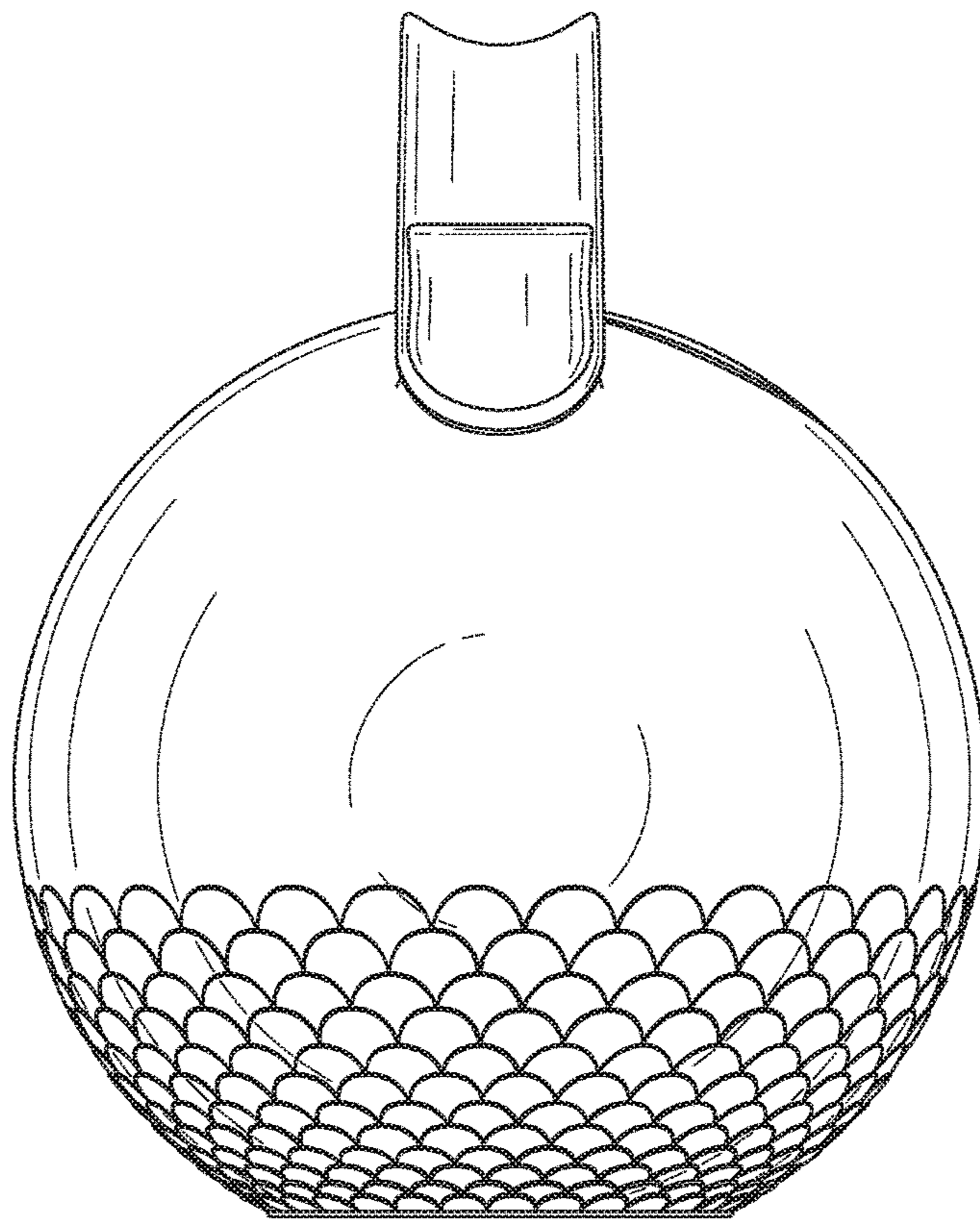

FIG. 7