



US00D864617S

(12) **United States Design Patent** (10) **Patent No.:** **US D864,617 S**  
**Pfister et al.** (45) **Date of Patent:** **\*\* Oct. 29, 2019**

(54) **MATTRESS COVER**

FOREIGN PATENT DOCUMENTS

(71) Applicant: **Tempur World, LLC**, Lexington, KY (US)

AU 201710516 3/2017  
AU 201710521 3/2017

(Continued)

(72) Inventors: **Brent Pfister**, Lexington, KY (US); **Oleg Bobrovskyj**, Sunds (DK); **Halina Bobrovska**, Sunds (DK); **Andrij Rupa**, Sunds (DK)

OTHER PUBLICATIONS

Tempur-Pedic Adapt Mattress, earliest review 2018, [online], [site visited Mar. 1, 2019], Available from Internet, URL: <https://www.tempurpedic.com/shop-mattresses/tempur-adapt/v/2602/> (Year: 2018).\*

(Continued)

(73) Assignee: **Tempur World, LLC**, Lexington, KY (US)

(\*\*) Term: **15 Years**

*Primary Examiner* — Michelle E. Wilson

(21) Appl. No.: **29/688,331**

*Assistant Examiner* — Sanjeev Paul

(22) Filed: **Apr. 19, 2019**

(74) *Attorney, Agent, or Firm* — Middleton Reutlinger

**Related U.S. Application Data**

(62) Division of application No. 29/634,313, filed on Jan. 19, 2018.

(57) **CLAIM**

(51) **LOC (12) Cl.** ..... **06-09**

The ornamental design for a mattress cover, as shown and described.

(52) **U.S. Cl.**

USPC ..... **D6/605**

(58) **Field of Classification Search**

USPC ..... D6/333, 349, 355, 375, 388, 512, 563, D6/564, 595, 596, 601, 604, 611, 707, D6/715, 716, 716.1; D24/183–185, 234; D21/803, 804, 805, 809; 5/401, 420, 5/600, 630, 631, 632, 633, 635, 636, 638, 5/639, 646, 652, 652.1, 655, 703, 730; 297/1, 2, 4, 93, 180.11, 195.1, 195.11, 297/195.13, 393, 397, 452.12, 452.14, 297/452.15, 452.21, 452.24, 452.26, 297/452.48, 452.62, 482

**DESCRIPTION**

FIG. 1 is a front elevational view of a mattress cover design; FIG. 2 is a rear elevational view of the design of FIG. 1; FIG. 3 is a left side elevational view of the design of FIG. 1; FIG. 4 is a right side elevational view of the design of FIG. 1; FIG. 5 is a top view of the design of FIG. 1; FIG. 6 is a bottom view of the design of FIG. 1; and, FIG. 7 is a perspective view of the design of FIG. 1. The broken lines shown in the drawings are included for the purpose of illustrating the unclaimed boundary and unclaimed portions of the mattress cover. The broken lines form no part of the claimed design.

(56) **References Cited**

**U.S. PATENT DOCUMENTS**

D37,358 S \* 2/1905 Haslup ..... D5/59  
D38,427 S 1/1907 Pronberger  
(Continued)

**1 Claim, 5 Drawing Sheets**

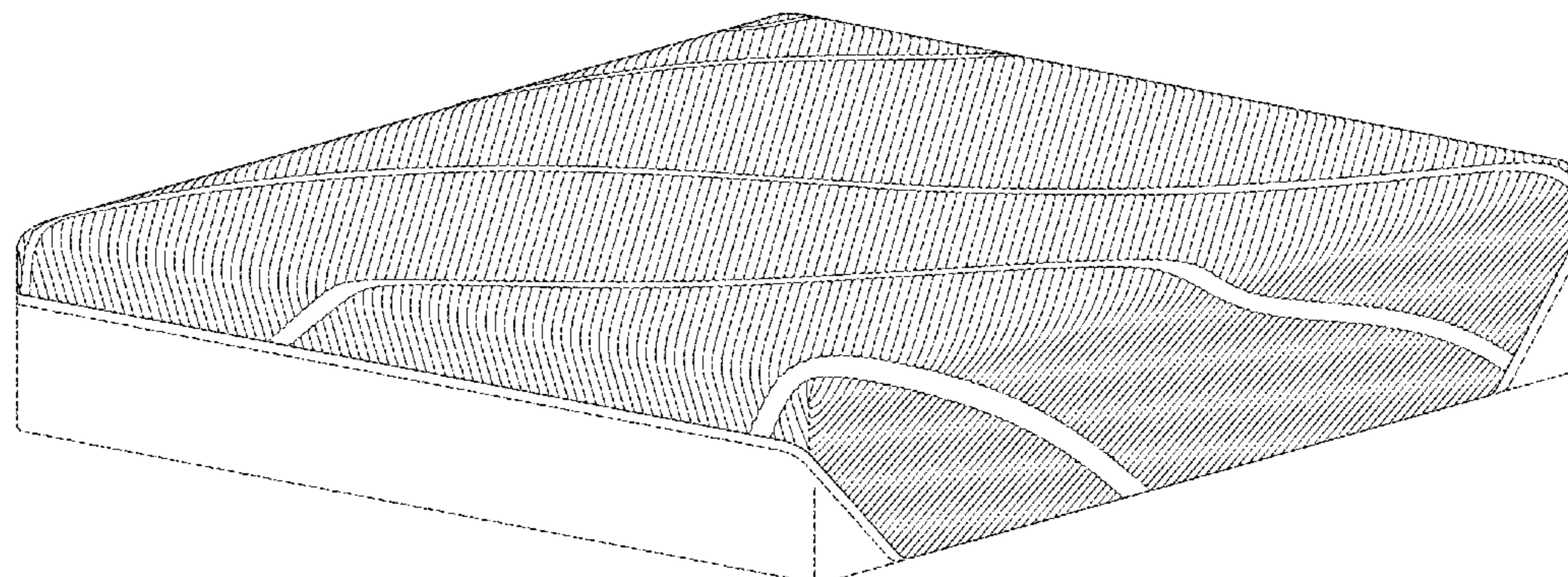

- (58) **Field of Classification Search**  
 CPC ..... A47G 9/10; A47G 9/1009; A47G 9/1027;  
 A47G 9/1045; A47G 9/1063; A47G  
 9/1072; A47G 9/1081  
 See application file for complete search history.

(56) **References Cited**

U.S. PATENT DOCUMENTS

D63,092 S \* 10/1923 Vandergaw ..... D5/57  
 D89,649 S \* 4/1933 Megroz ..... D5/7  
 D113,261 S \* 2/1939 Fassler ..... D6/603  
 D182,349 S \* 3/1958 Alvord ..... D25/154  
 D202,091 S 8/1965 Broderick  
 D353,072 S 12/1994 Cornell, Jr. et al.  
 D413,731 S \* 9/1999 Hannington ..... D5/61  
 D419,781 S \* 2/2000 Pratt ..... D5/53  
 6,199,231 B1 3/2001 Zafiroglu  
 6,216,292 B1 4/2001 Oakhill et al.  
 D441,540 S \* 5/2001 Enderby ..... D5/53  
 6,253,398 B1 7/2001 Yim  
 6,467,521 B1 \* 10/2002 Pratt ..... B29C 70/20  
 156/351  
  
 D488,661 S 4/2004 Barman  
 D517,848 S 3/2006 Contreras  
 D518,672 S 4/2006 Contreras  
 D519,311 S 4/2006 Contreras  
 D525,437 S \* 7/2006 Leisch ..... D5/53  
 D562,567 S \* 2/2008 Proserpio ..... D5/56  
 D587,055 S 2/2009 Tucker  
 D600,485 S 9/2009 Tucker  
 D606,353 S 12/2009 Tucker  
 D616,236 S 5/2010 Morrison  
 D621,198 S 8/2010 Morrison  
 D622,088 S 8/2010 Morrison  
 D622,531 S 8/2010 Morrison et al.  
 D622,996 S 9/2010 Morrison et al.  
 D634,148 S 3/2011 Morrison  
 D636,607 S \* 4/2011 Withers ..... A47J 36/02  
 D5/56  
  
 D640,082 S 6/2011 Morrison  
 D642,847 S 8/2011 Rinehart  
 D650,994 S \* 12/2011 Sheehan ..... D5/56  
 D662,751 S 7/2012 Morrison et al.  
 D662,752 S 7/2012 Morrison et al.  
 D666,448 S 9/2012 Morrison et al.  
 D666,449 S 9/2012 Morrison et al.  
 D670,950 S 11/2012 Price  
 D690,962 S 10/2013 Danileson  
 D696,048 S 12/2013 Morrison  
 8,721,073 B2 \* 5/2014 Bowers ..... G02C 7/046  
 351/159.31  
  
 D719,763 S 12/2014 Enders  
 D719,764 S \* 12/2014 Enders ..... D5/55  
 D720,158 S \* 12/2014 Harmening ..... D5/56  
 D723,839 S 3/2015 Bond et al.  
 D724,353 S 3/2015 Johnson et al.  
 D724,864 S \* 3/2015 Harmening ..... D5/56  
 D724,865 S \* 3/2015 Jensen ..... D5/56  
 D724,866 S 3/2015 Johnson et al.  
 D725,943 S 4/2015 Oberwelz et al.  
 D726,452 S \* 4/2015 Jensen ..... D5/55  
 D727,663 S 4/2015 Jensen  
 D728,275 S 5/2015 Jensen et al.  
 D728,276 S 5/2015 Jensen et al.  
 D728,277 S 5/2015 Jensen et al.  
 D733,464 S 7/2015 Nielsen et al.  
 D741,622 S 10/2015 Jensen et al.  
 D742,660 S \* 11/2015 Oberwelz ..... D6/606  
 D744,766 S 12/2015 Morrison et al.  
 D744,767 S 12/2015 Morrison et al.  
 D744,768 S 12/2015 Morrison et al.  
 D746,082 S \* 12/2015 Harmening ..... D6/605  
 D746,083 S 12/2015 Jensen et al.  
 D746,084 S 12/2015 Jensen et al.  
 D746,085 S 12/2015 Jensen et al.  
 D753,934 S 4/2016 Daeseleire

D762,079 S \* 7/2016 Oberwelz ..... D6/606  
 D763,602 S 8/2016 Oberwelz et al.  
 D766,017 S 9/2016 Jensen et al.  
 D767,306 S 9/2016 Oberwelz et al.  
 D776,960 S 1/2017 Suzuki et al.  
 9,601,034 B2 3/2017 Jensen et al.  
 D784,733 S 4/2017 Bell et al.  
 D785,972 S \* 5/2017 Oberwelz ..... D6/602  
 9,675,189 B2 6/2017 Jensen et al.  
 D802,964 S \* 11/2017 Alletto, Jr. .... D6/605  
 D804,221 S \* 12/2017 Alletto, Jr. .... D6/605  
 D804,854 S \* 12/2017 Bunnell ..... D6/606  
 D804,856 S \* 12/2017 Desodt ..... D6/606  
 D804,857 S \* 12/2017 Desodt ..... D6/606  
 D804,858 S \* 12/2017 Desodt ..... D6/606  
 D804,859 S \* 12/2017 Desodt ..... D6/606  
 D805,327 S 12/2017 Desodt et al.  
 D805,328 S \* 12/2017 Desodt ..... D6/606  
 D811,127 S 2/2018 Bell et al.  
 D811,128 S 2/2018 Bell et al.  
 D811,776 S 3/2018 Desodt et al.  
 D820,006 S \* 6/2018 Desodt ..... D6/606  
 D820,618 S \* 6/2018 Desodt ..... D6/606  
 9,997,089 B2 6/2018 Jensen et al.  
 D823,029 S 7/2018 Jensen et al.  
 D833,178 S \* 11/2018 Desodt ..... D6/606  
 D833,179 S \* 11/2018 Desodt ..... D6/606  
 D833,180 S \* 11/2018 Desodt ..... D6/606  
 D833,778 S 11/2018 Desodt et al.  
 D842,008 S 3/2019 Desodt et al.  
 D845,677 S 4/2019 Desodt et al.  
 2010/0138992 A1 6/2010 Morrison  
 2014/0196647 A1 7/2014 Myers et al.  
 2016/0051059 A1 2/2016 Jensen et al.  
 2017/0238717 A1 8/2017 Jensen et al.  
 2018/0277022 A1 9/2018 Jensen et al.

FOREIGN PATENT DOCUMENTS

AU 201711499 4/2017  
 AU 201711595 4/2017  
 CA 2935622 7/2015  
 CA 2935633 7/2015  
 CA 2956140 2/2016  
 CA 2935627 7/2017  
 CA 172825 11/2017  
 CA 172826 11/2017  
 CA 176686 11/2017  
 CA 176706 11/2017  
 CN 105979822 9/2016  
 CN 105979823 9/2016  
 CN 105979825 9/2016  
 CN 1476499 1/2018  
 CN ZL201730031670.4 3/2018  
 EM 003729714-0001 1/2017  
 EM 003729714-0002 1/2017  
 EM 3729722-0001-0002 1/2017  
 EP 3089621 11/2016  
 EP 3089624 11/2016  
 EP 3089626 10/2018  
 ES 2485966 8/2014  
 JP 1583849 3/2017  
 JP 1589164 10/2017  
 JP 1592012 11/2017  
 JP 1592014 11/2017  
 KR 3009310900001-02 11/2017  
 TW D166222 3/2015  
 WO 2015020643 2/2015  
 WO 2015103171 7/2015  
 WO 2015103177 7/2015  
 WO 2015103186 7/2015  
 WO 2016018703 2/2016

OTHER PUBLICATIONS

Tempurpedic Adapt Med Mattress Expert Review, reviewed Apr.  
 30, 2018, [online], [site visited Jun. 18, 2019]. Available from

(56)

**References Cited**

OTHER PUBLICATIONS

YouTube, URL: [https://www.youtube.com/watch?v=X1eB\\_pvNQJw](https://www.youtube.com/watch?v=X1eB_pvNQJw) (Year: 2018).\*

Stearns & Foster Estate Collection; <http://www.houstondiscountmattresses.com/stearns-foster-estate-basic.html>; 1 page; accessed Jun. 1, 2018.

Tempur-Pro Adapt, earliest review Aug. 2018, [online], [site visited Mar. 1, 2019]. Available from Internet, URL: <https://www.tempurpedic.com/shop-mattresses/tempur-proadapt/v/2577/> (Year: 2018).

Sealy Hybrid Mattress, earliest review 2018, [online], [site visited Mar. 1, 2019]. Available from Internet, URL: <https://www.sealy.com/mattresses/lines/hybrid/> (Year: 2018).

\* cited by examiner

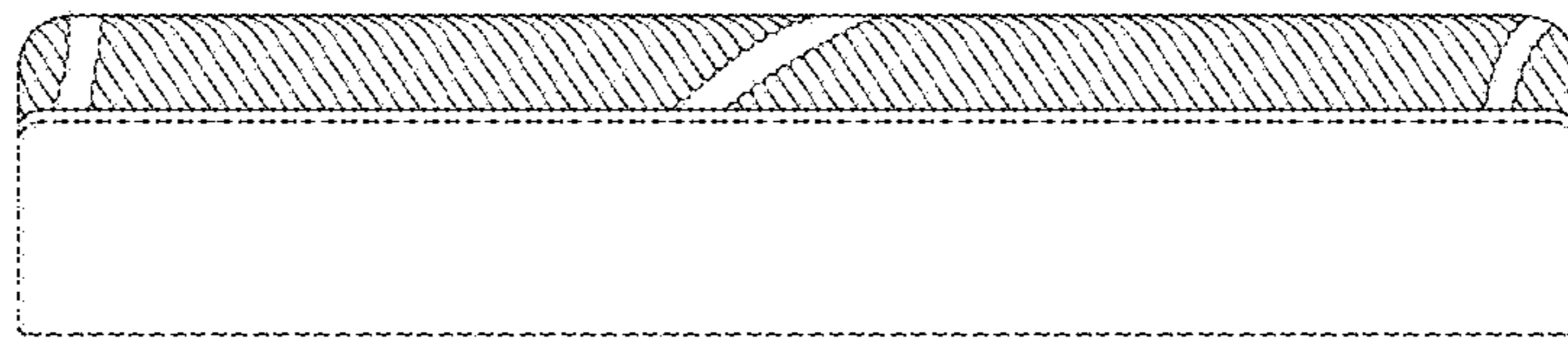

FIG. 1

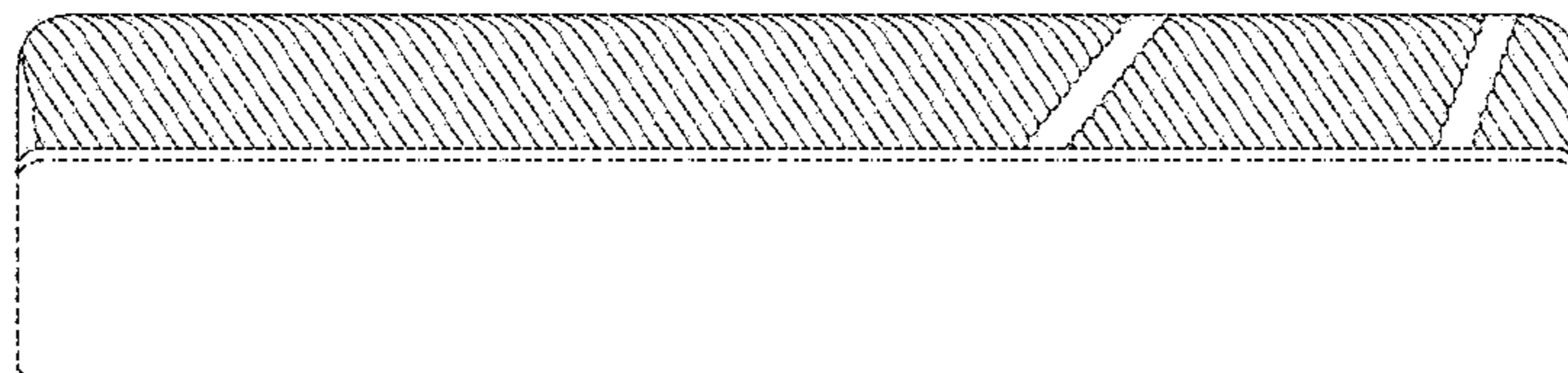

FIG. 2

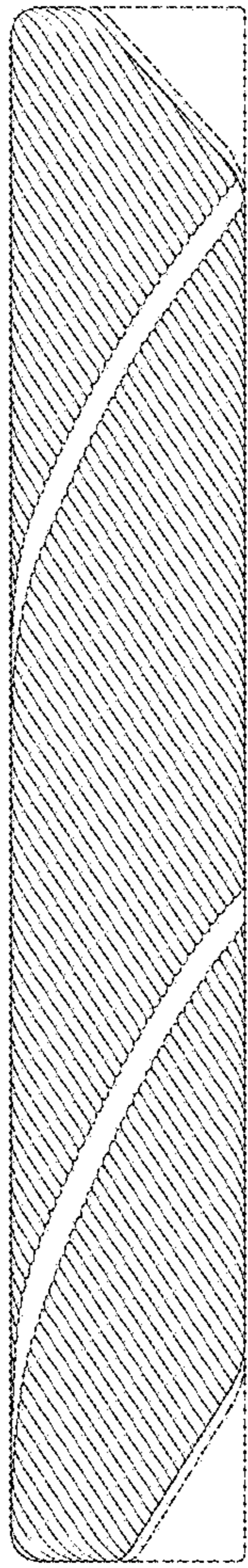

FIG. 3

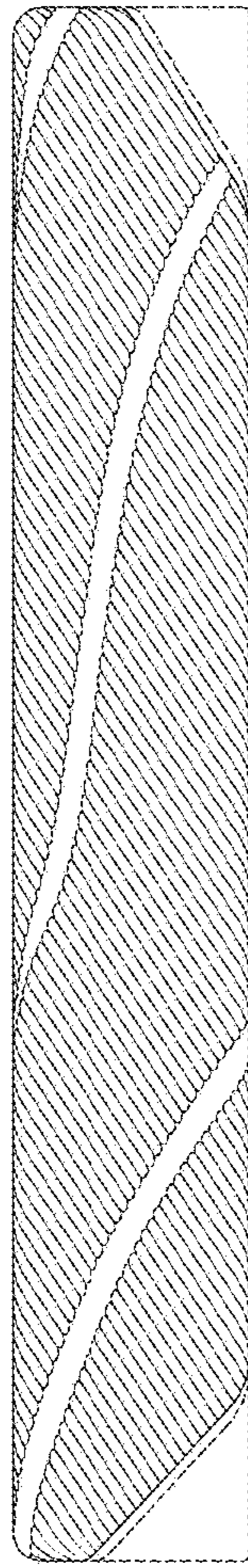

FIG. 4

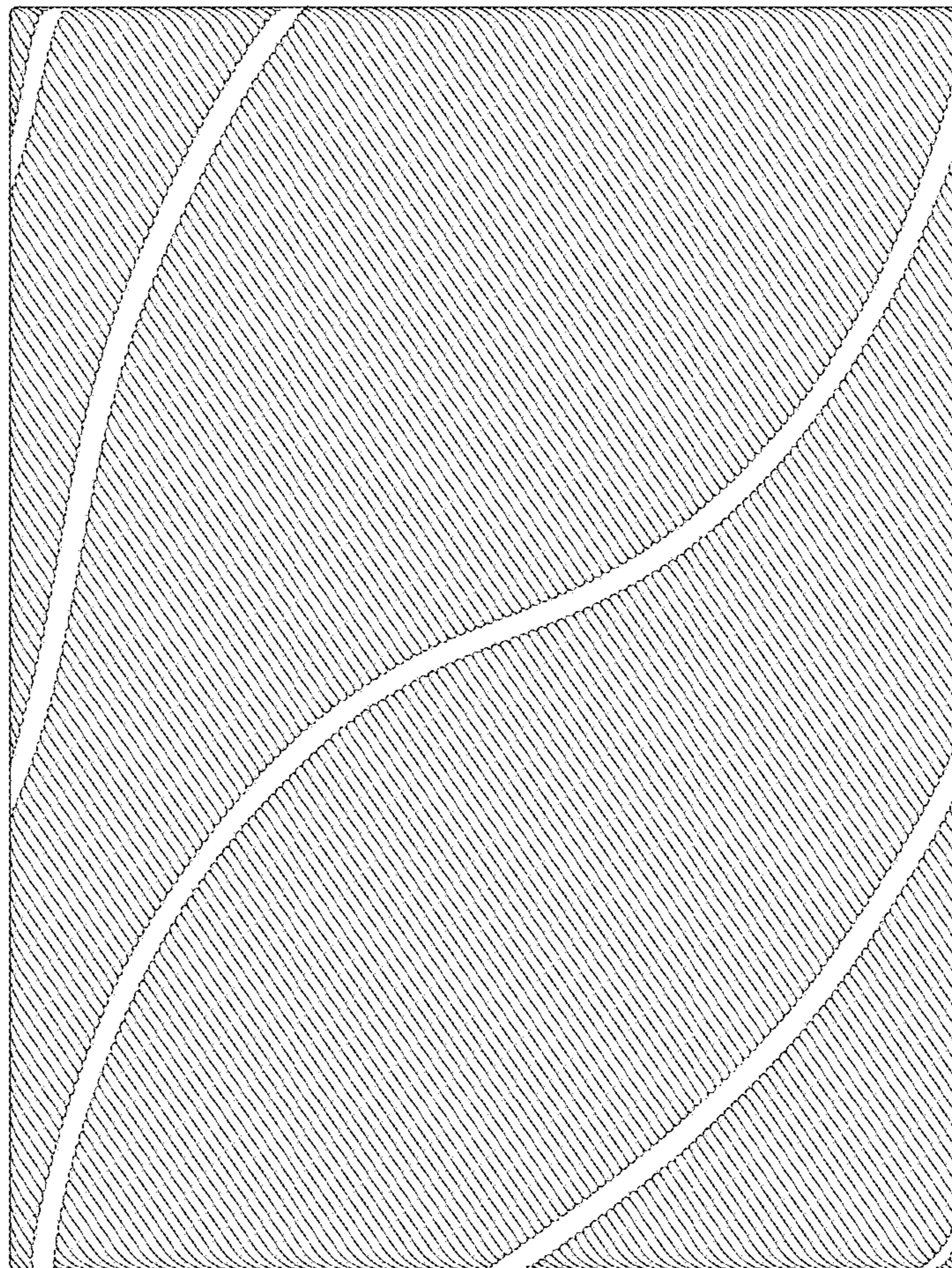

FIG. 5

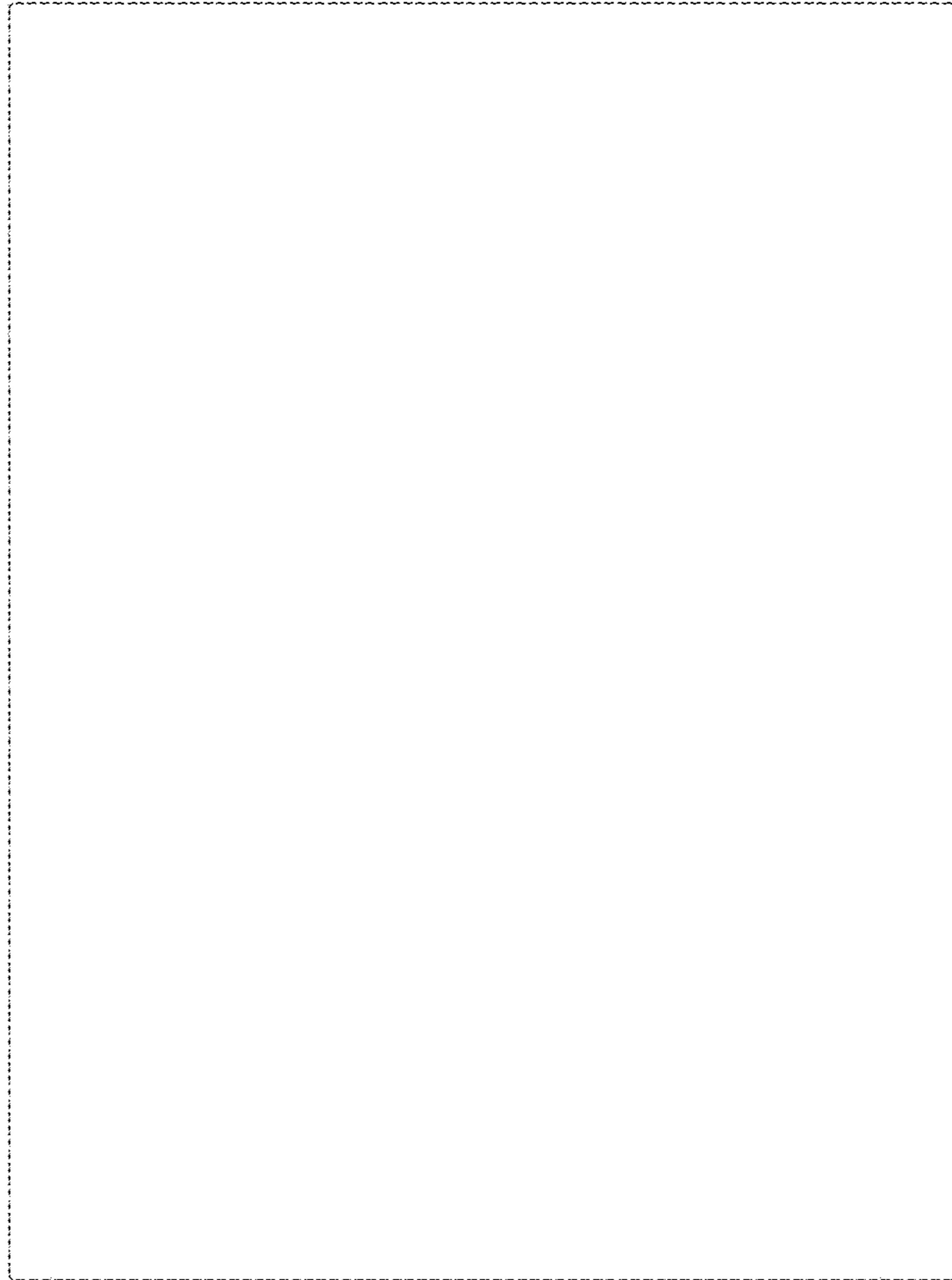

FIG. 6

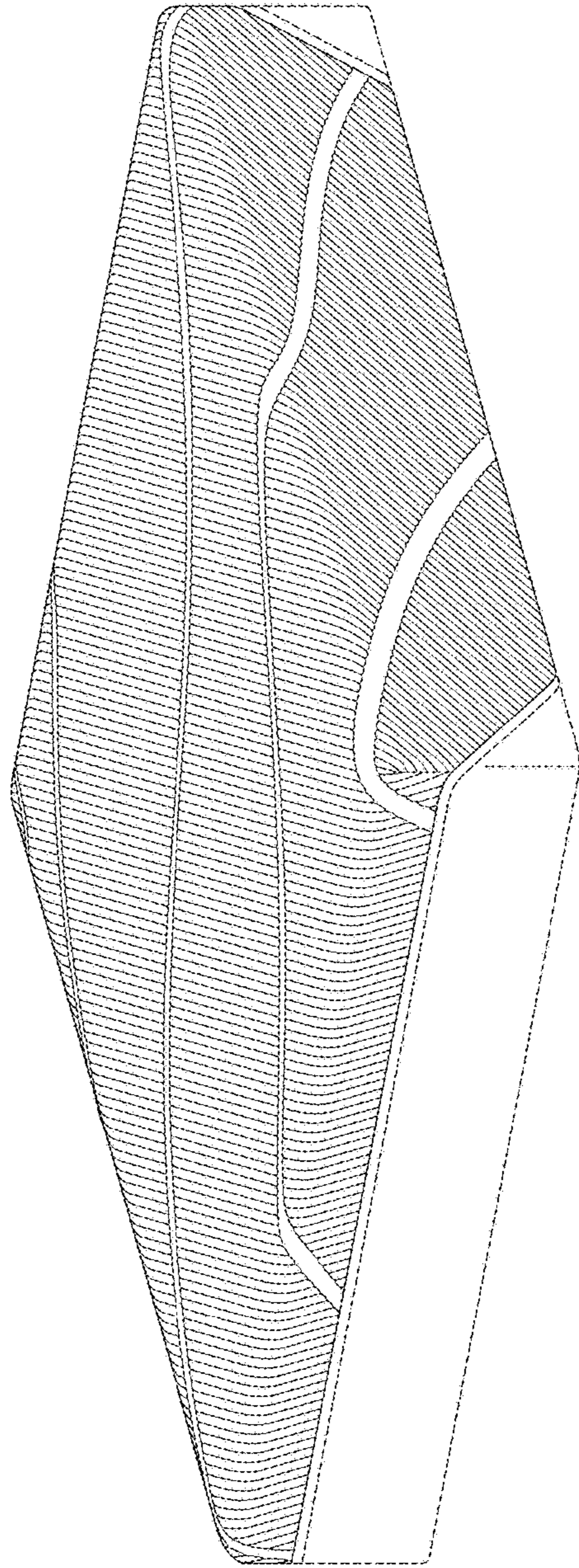

FIG. 7