



US00D864523S

(12) **United States Design Patent** (10) **Patent No.:** **US D864,523 S**  
**Diamond et al.** (45) **Date of Patent:** **\*\* Oct. 29, 2019**

(54) **SUPPORTIVE GARMENT**

(71) Applicants: **Craig H. Diamond**, Highland Park, IL (US); **Alexander Coriano, III**, Brisbane, CA (US); **Brian Witlin**, Mountain View, CA (US)

(72) Inventors: **Craig H. Diamond**, Highland Park, IL (US); **Alexander Coriano, III**, Brisbane, CA (US); **Brian Witlin**, Mountain View, CA (US)

(73) Assignee: **Craig H. Diamond**, Highland Park, IL (US)

(\*\*) Term: **15 Years**

(21) Appl. No.: **29/625,831**

(22) Filed: **Nov. 13, 2017**

(51) **LOC (12) Cl.** ..... **02-01**

(52) **U.S. Cl.**  
USPC ..... **D2/712**

(58) **Field of Classification Search**  
USPC ..... D2/711–713, 738  
CPC ..... A41D 7/00; A41D 7/005; A41D 1/062;  
A41D 1/065; A41D 1/067; A41D 1/08  
See application file for complete search history.

(56) **References Cited**

**U.S. PATENT DOCUMENTS**

D191,908 S *	12/1961	Goldstein	.....	450/105
D339,902 S *	10/1993	Doherty	.....	D2/738
D657,937 S *	4/2012	Jones	.....	D2/712
D710,067 S *	8/2014	Nearman	.....	D2/712
D722,420 S *	2/2015	Abrams	.....	D2/712
D722,742 S *	2/2015	Abrams	.....	D2/712
D759,345 S *	6/2016	Astin	.....	D2/712
D798,530 S *	10/2017	Cook	.....	D2/700
D838,931 S *	1/2019	Yan	.....	D2/712
2018/0035736 A1 *	2/2018	Le	.....	A41D 1/06

\* cited by examiner

*Primary Examiner* — Catherine R Oliver-Garcia

*Assistant Examiner* — J. Thorn, Sr.

(74) *Attorney, Agent, or Firm* — Quarles & Brady LLP

(57) **CLAIM**

The ornamental design for a supportive garment, as shown and described.

**DESCRIPTION**

FIG. 1 is a perspective view of a supportive garment showing our new design;  
 FIG. 2 is a front elevational view thereof;  
 FIG. 3 is a rear elevational view thereof;  
 FIG. 4 is a side elevational view thereof;  
 FIG. 5 is a top plan view thereof;  
 FIG. 6 is a bottom plan view thereof;  
 FIG. 7 is a perspective view of FIG. 1, shown in an inside—out configuration;  
 FIG. 8 is a front elevational view thereof;  
 FIG. 9 is a rear elevational view thereof;  
 FIG. 10 is a side elevational view thereof;  
 FIG. 11 is a top plan view thereof;  
 FIG. 12 is a bottom plan view thereof;  
 FIG. 13 is a perspective view of a supportive garment, shown in a second embodiment;  
 FIG. 14 is a front elevational view thereof;  
 FIG. 15 is a rear elevational view thereof;  
 FIG. 16 is a side elevational view thereof;  
 FIG. 17 is a top plan view thereof;  
 FIG. 18 is a bottom plan view thereof;  
 FIG. 19 is a perspective view of FIG. 13, shown in an inside—out configuration;  
 FIG. 20 is a front elevational view thereof;  
 FIG. 21 is a rear elevational view thereof;  
 FIG. 22 is a side elevational view thereof;  
 FIG. 23 is a top plan view thereof; and,  
 FIG. 24 is a bottom plan view thereof.  
 The broken lines shown in the drawings form no part of the claimed design.

**1 Claim, 16 Drawing Sheets**

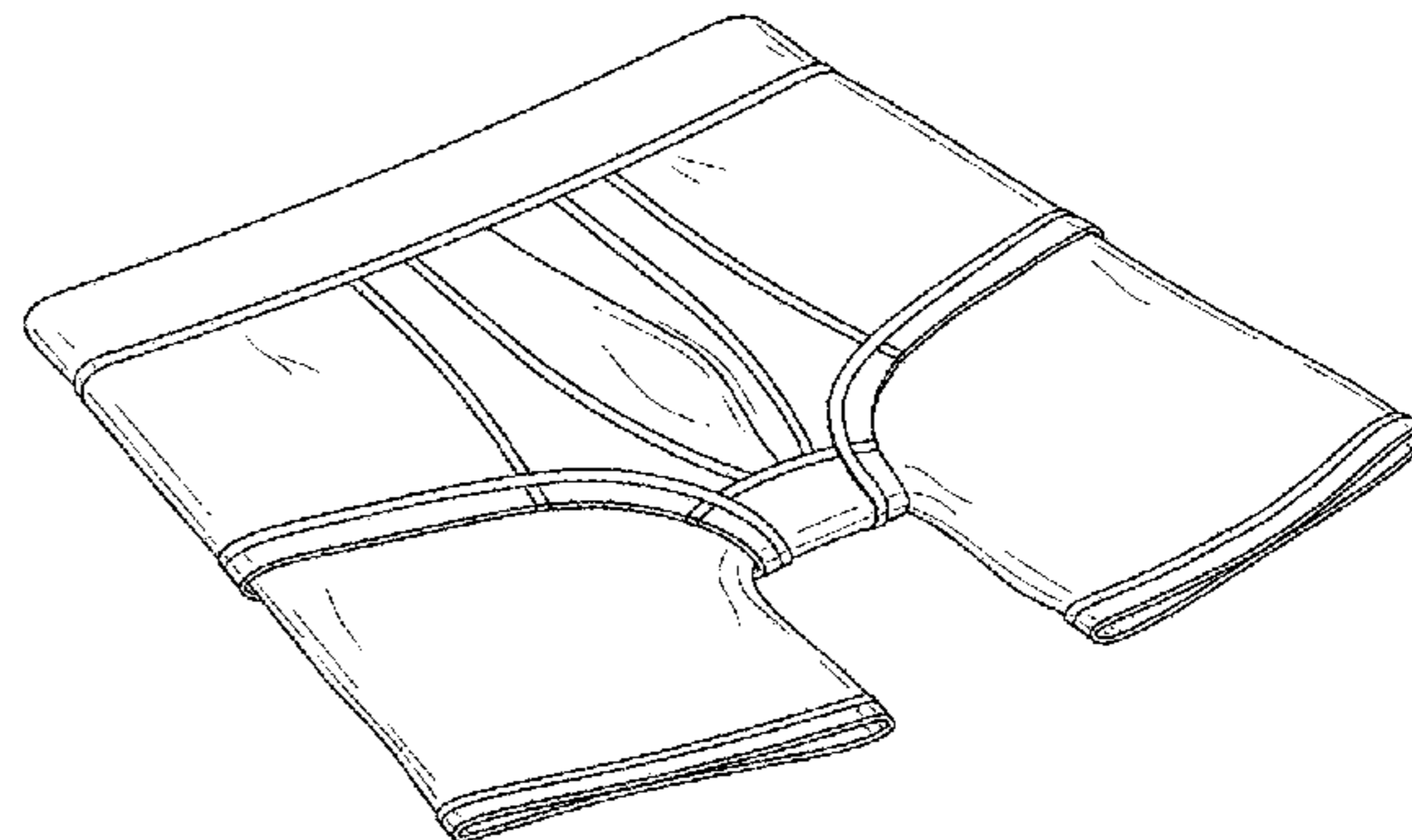
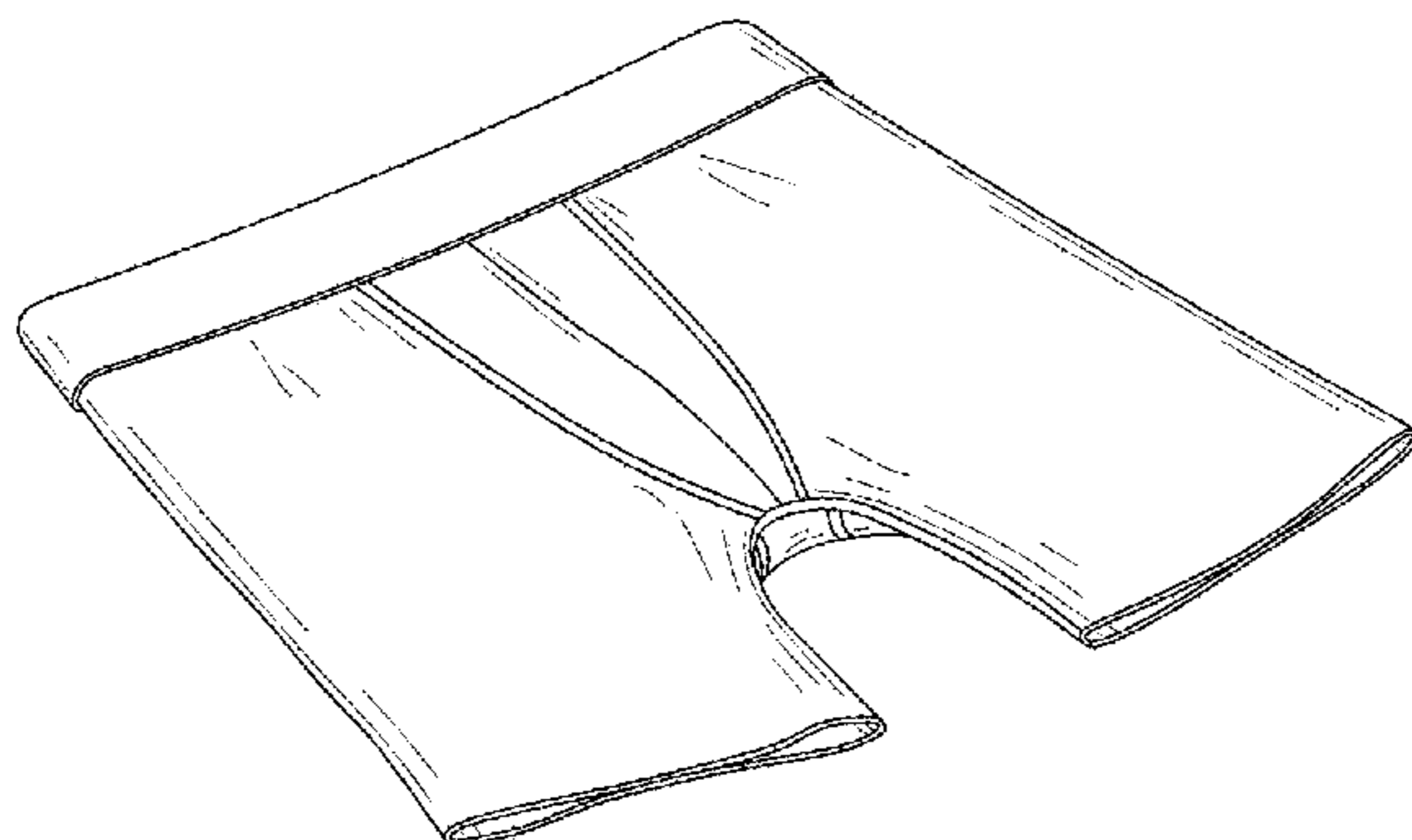

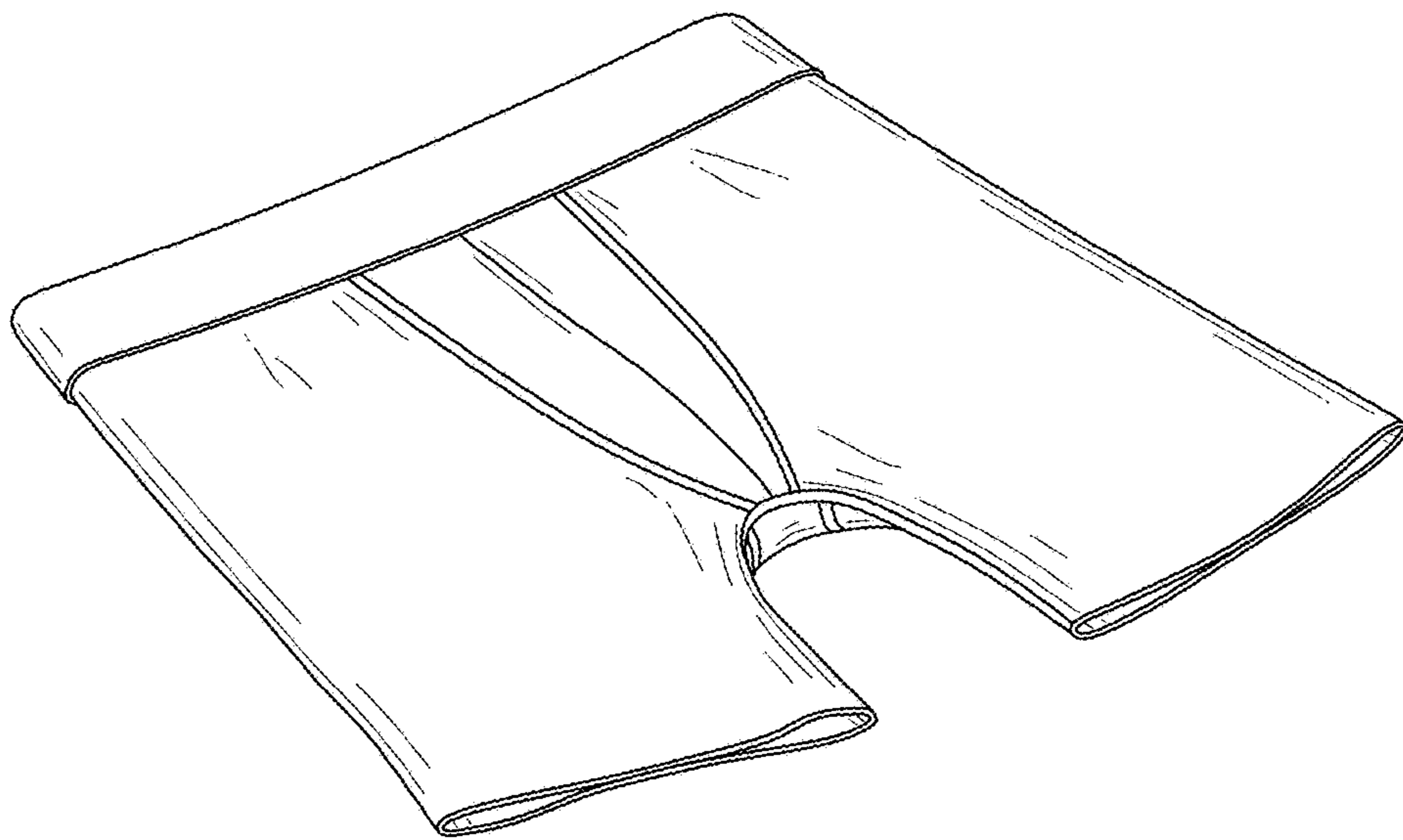

FIG. 1

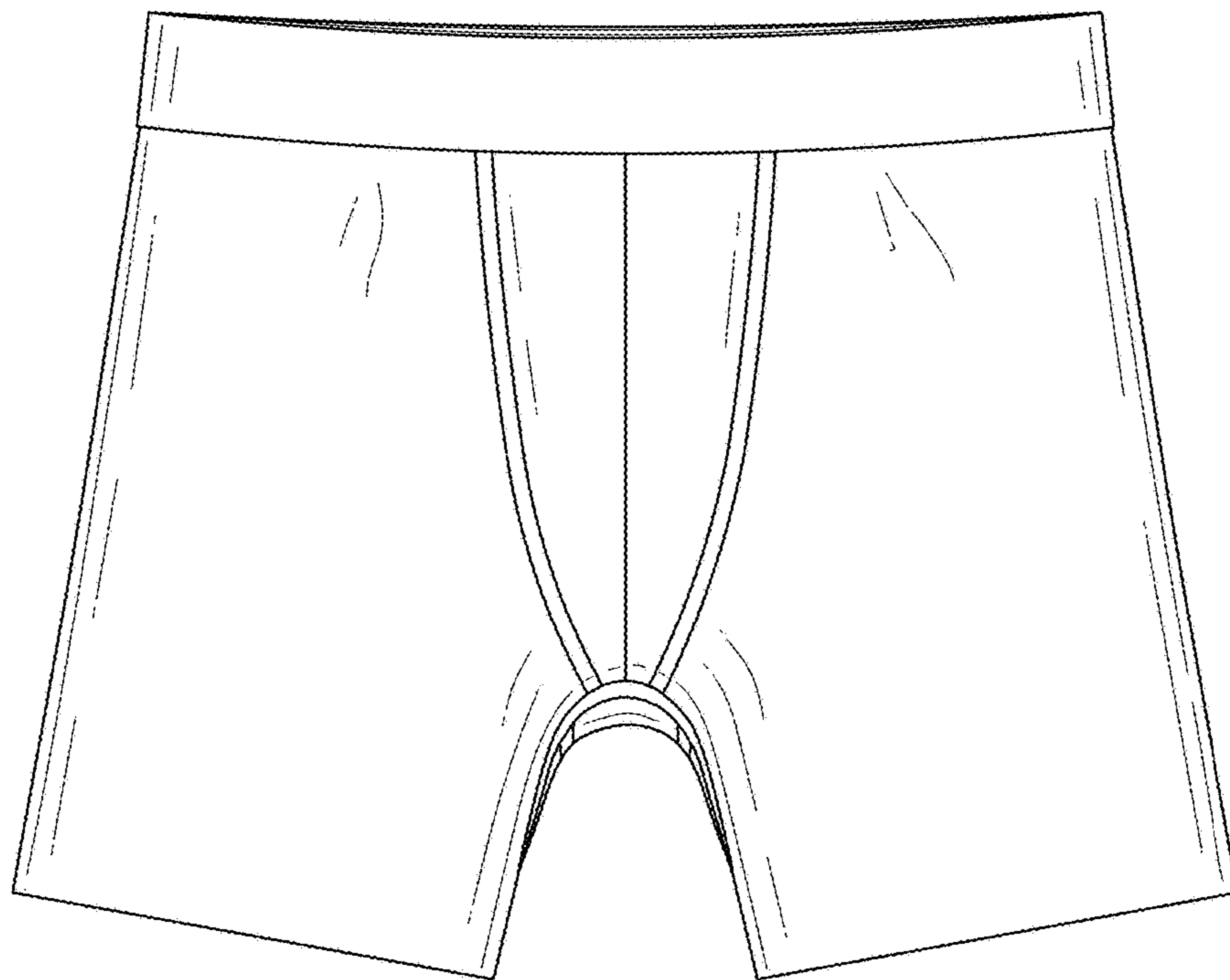

FIG. 2

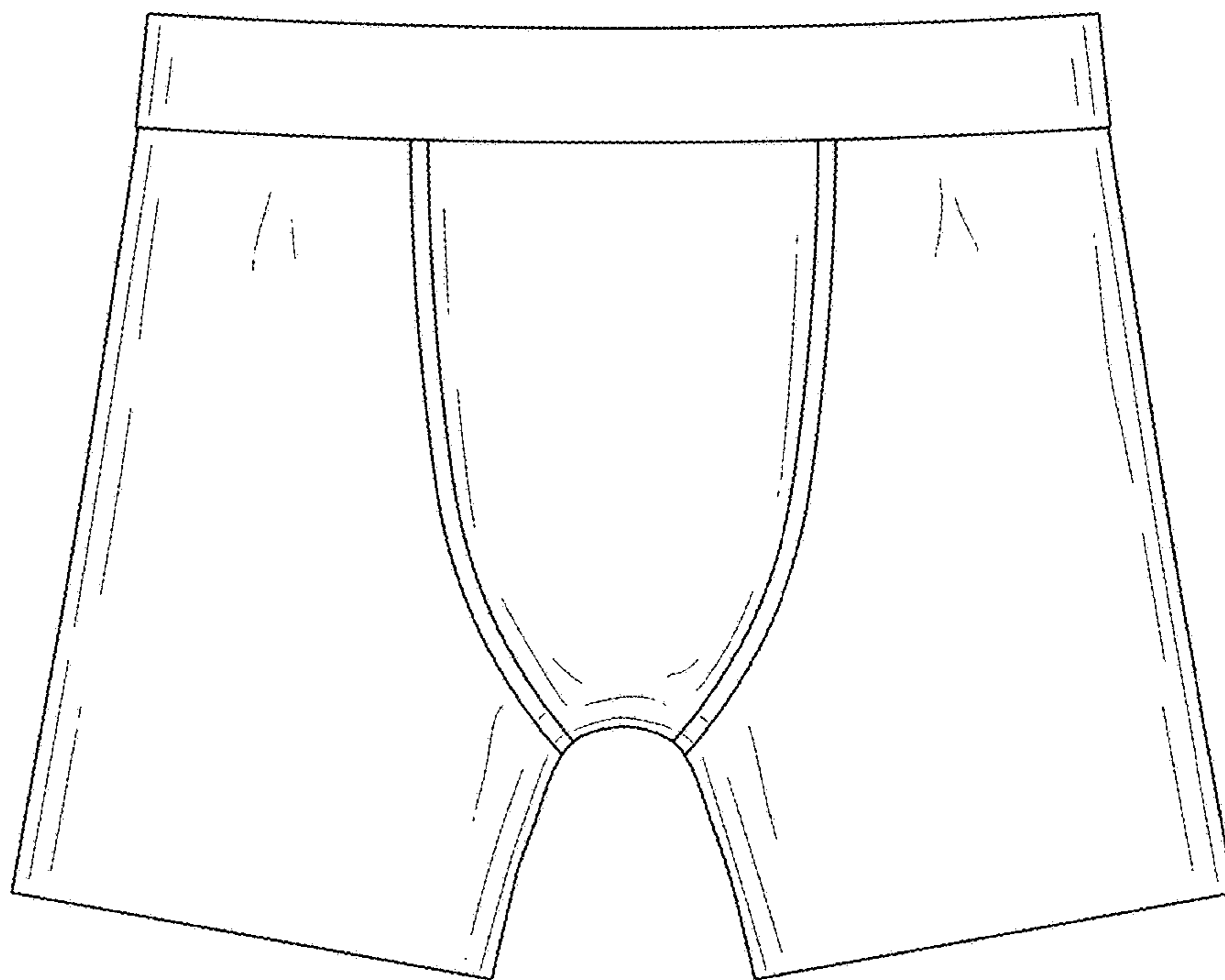

FIG. 3

FIG. 4

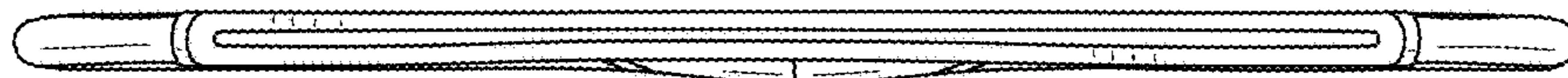
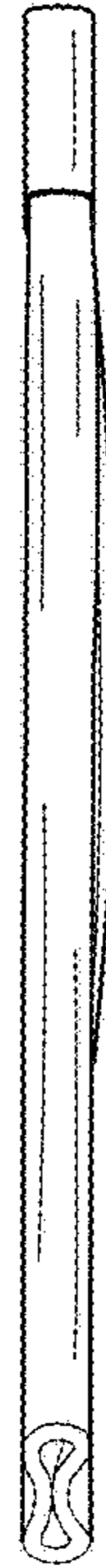

FIG. 5

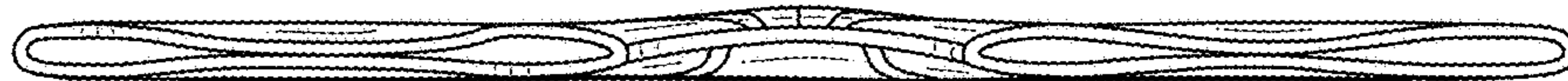

FIG. 6

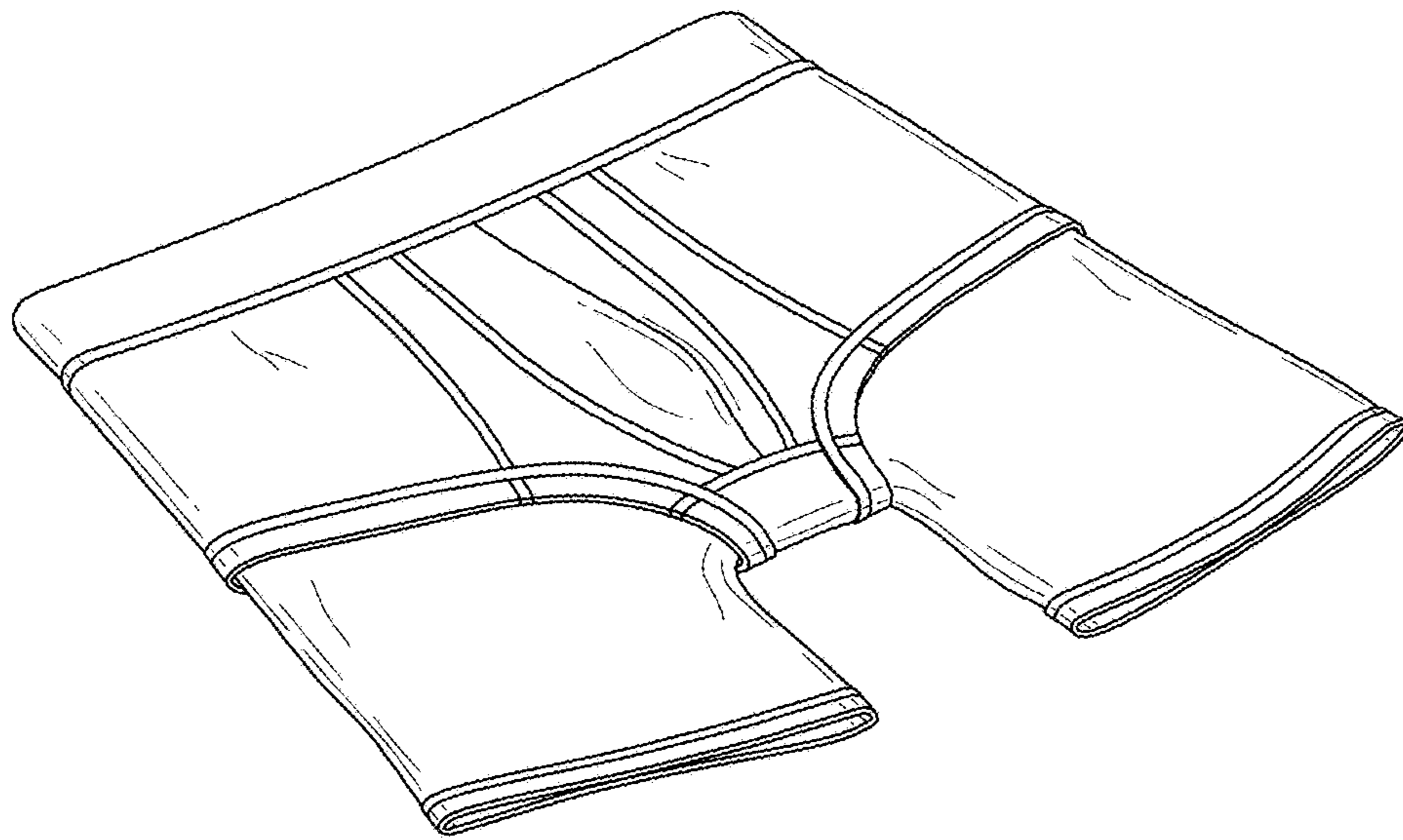

FIG. 7

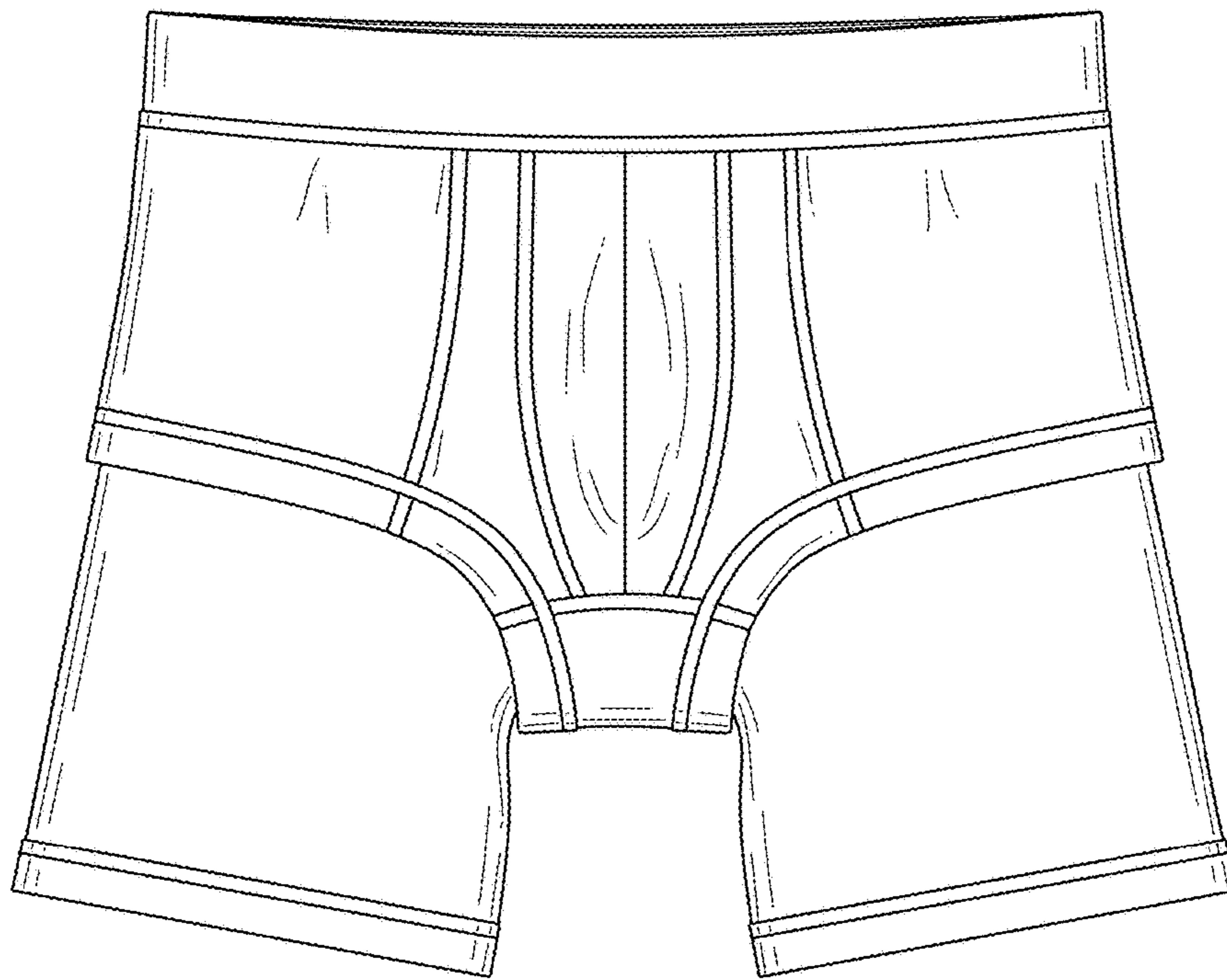

FIG. 8

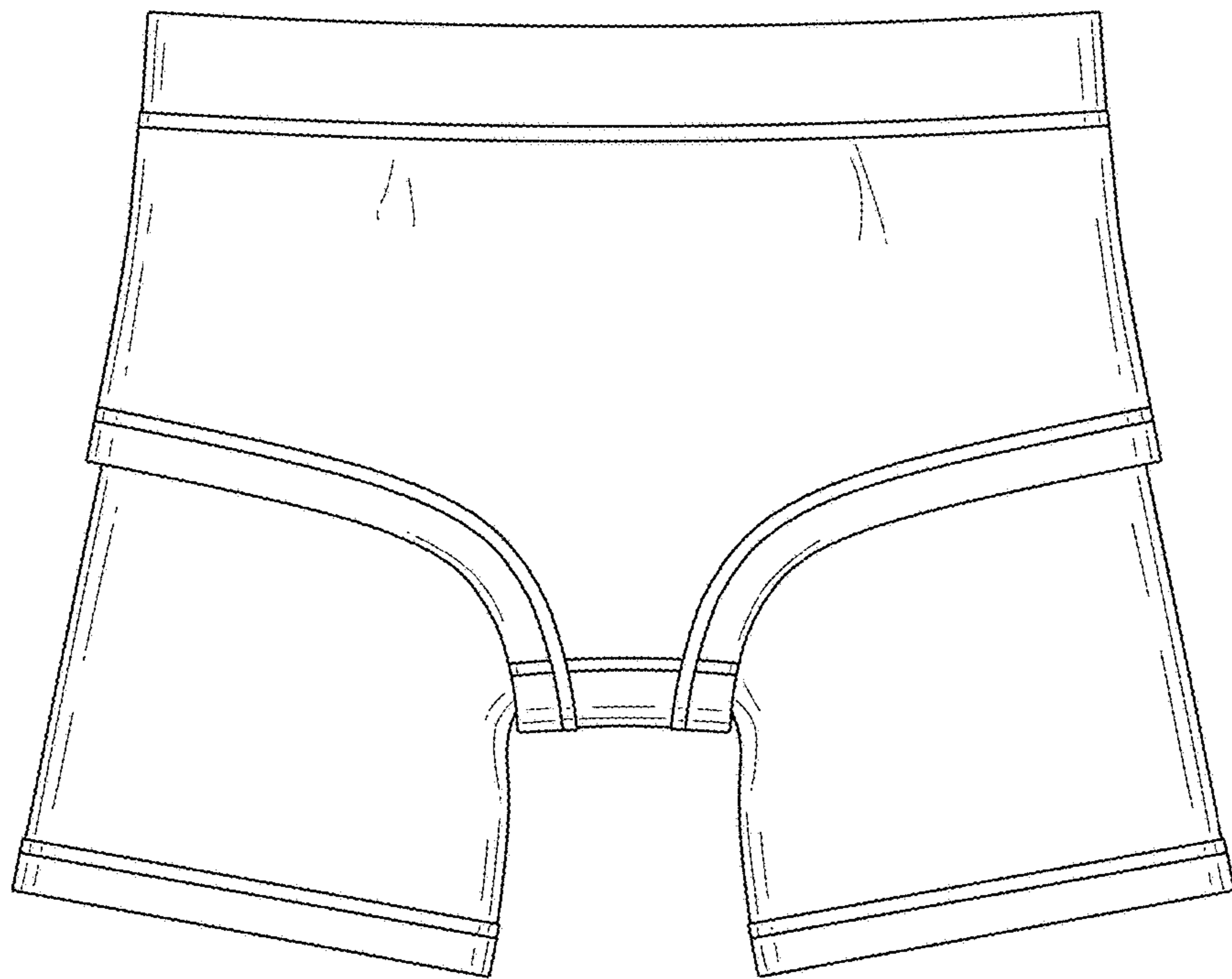

FIG. 9



FIG. 10



FIG. 11

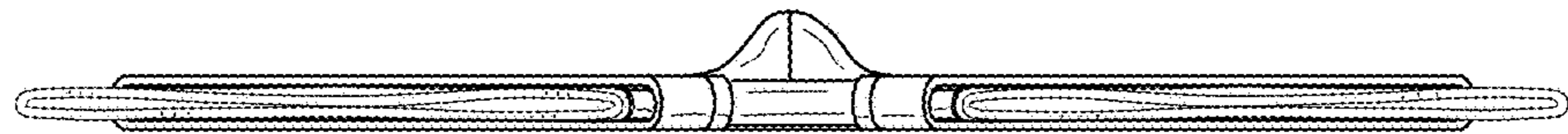

FIG. 12

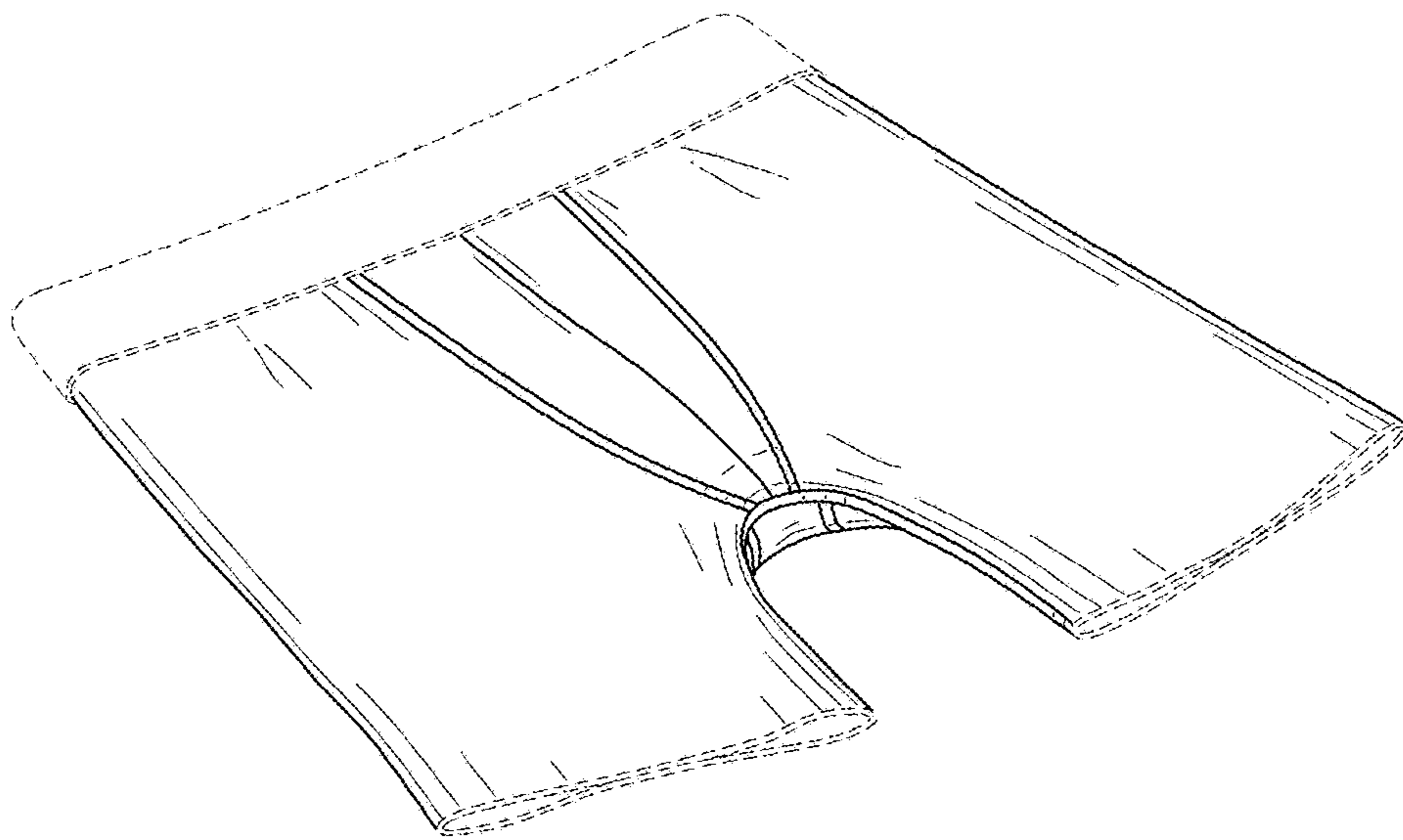

FIG. 13

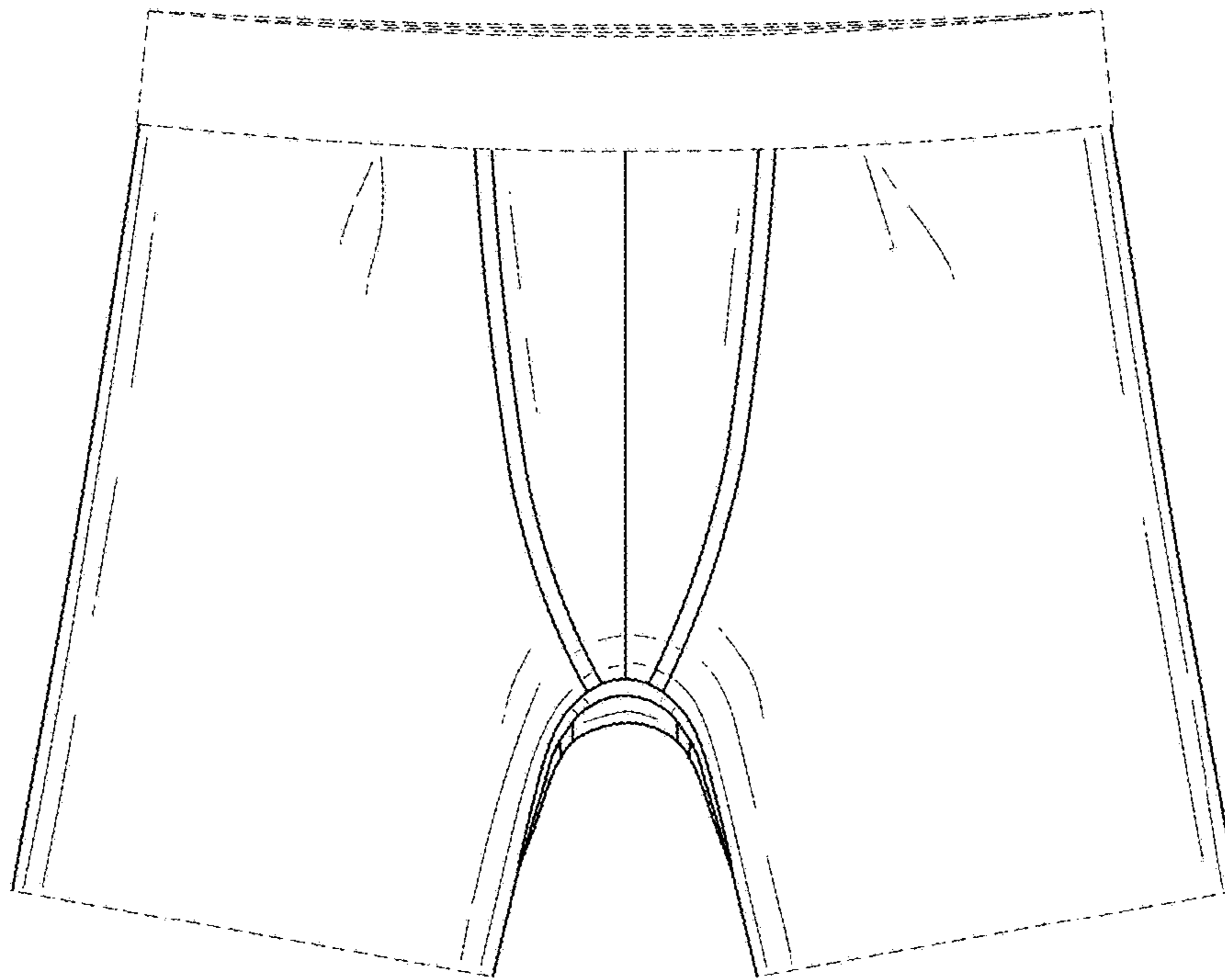

FIG. 14

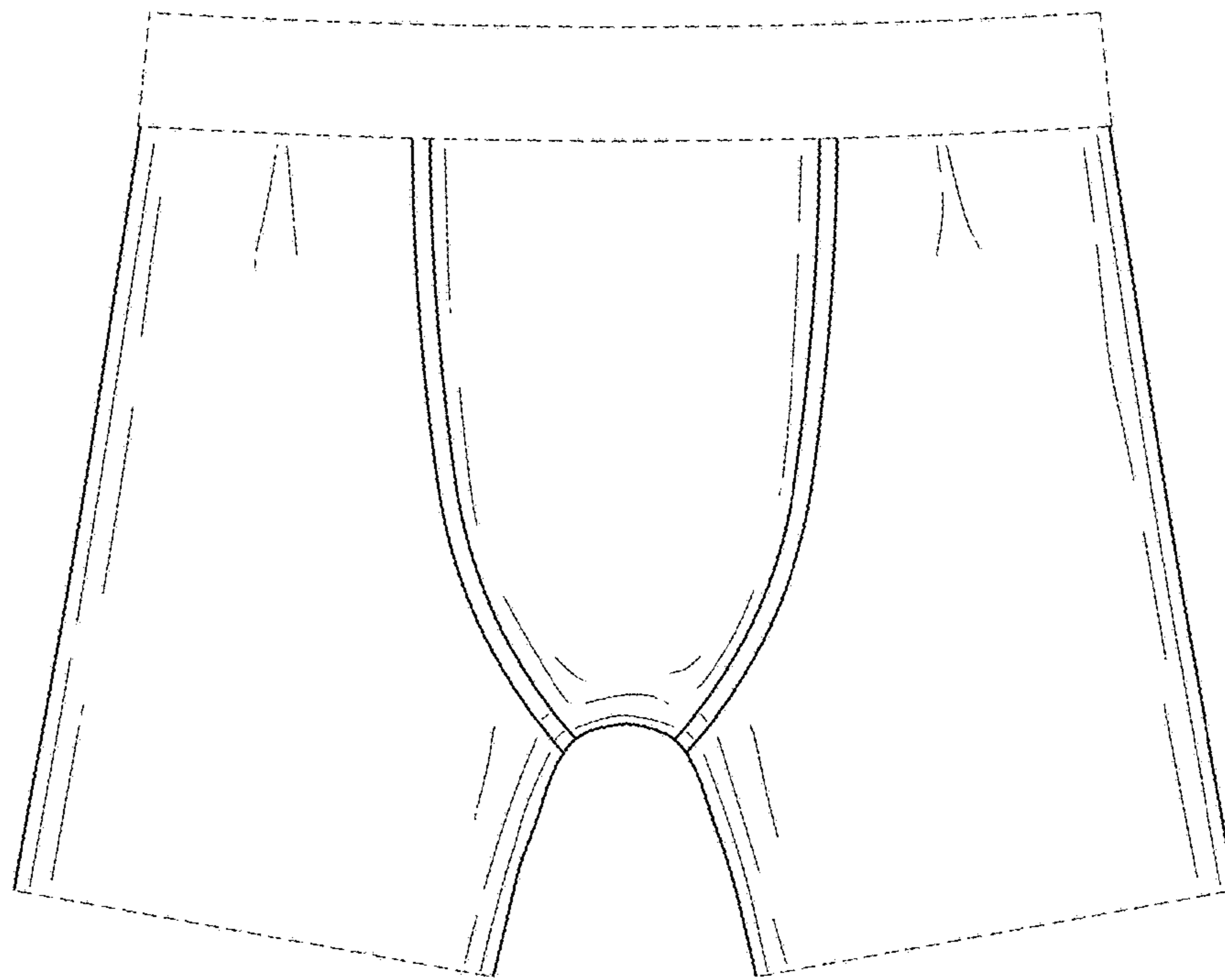

FIG. 15

FIG. 16

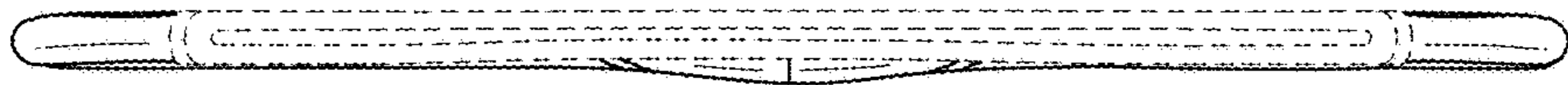
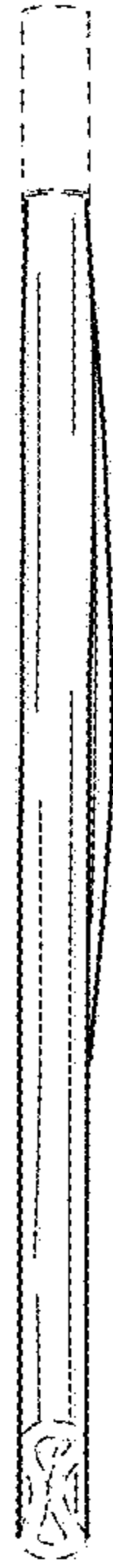

FIG. 17

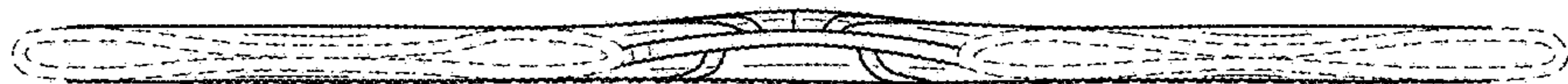

FIG. 18

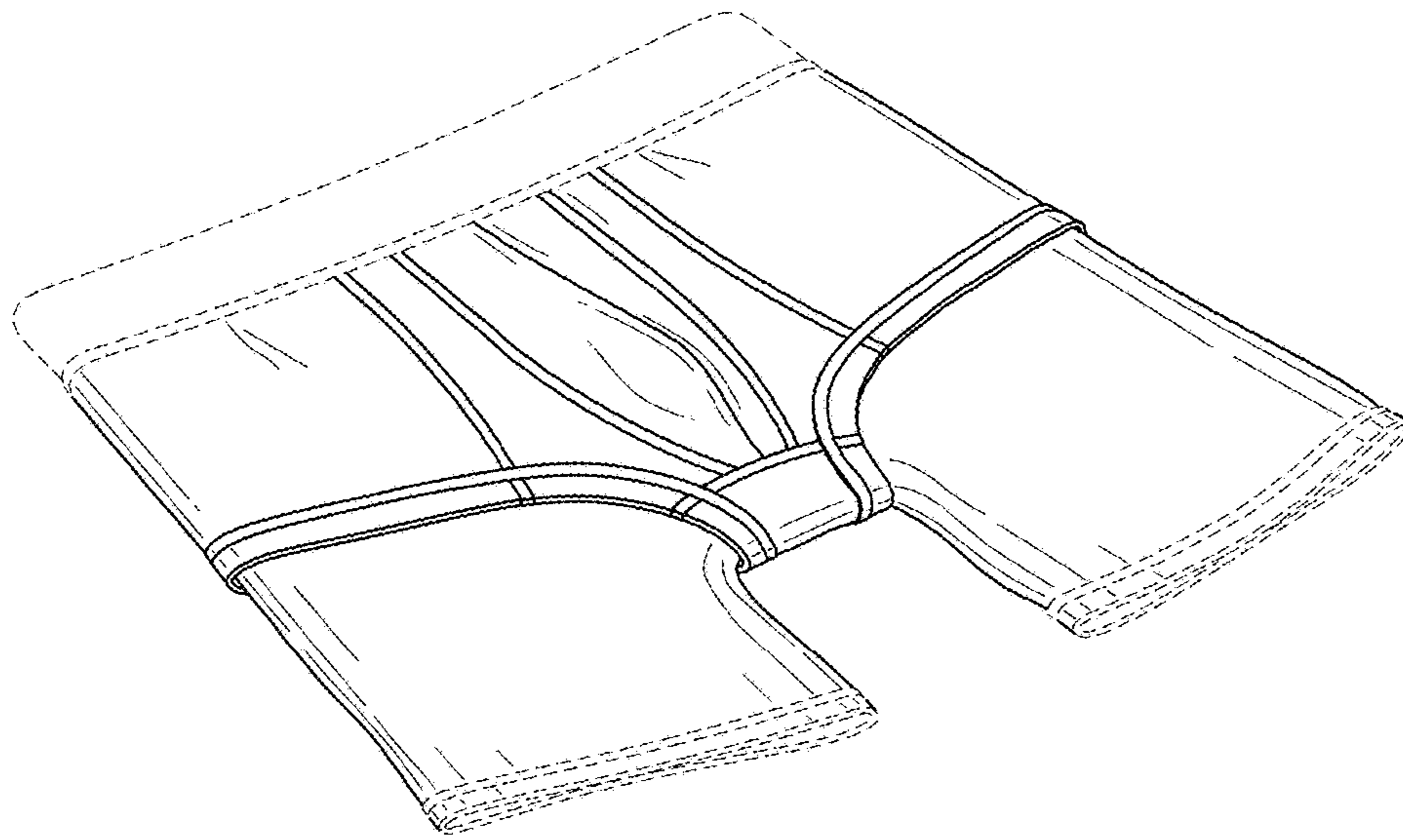

FIG. 19

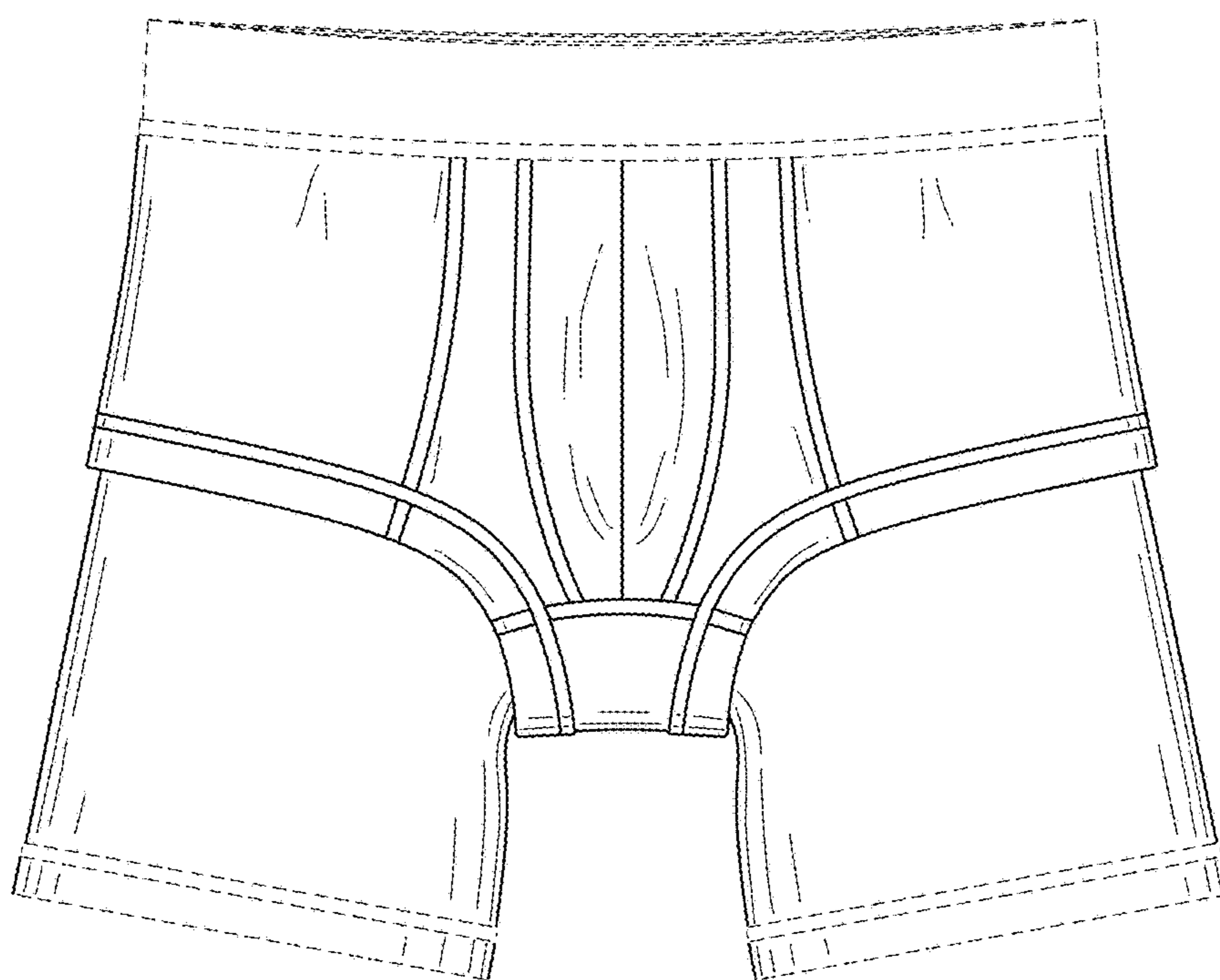

FIG. 20

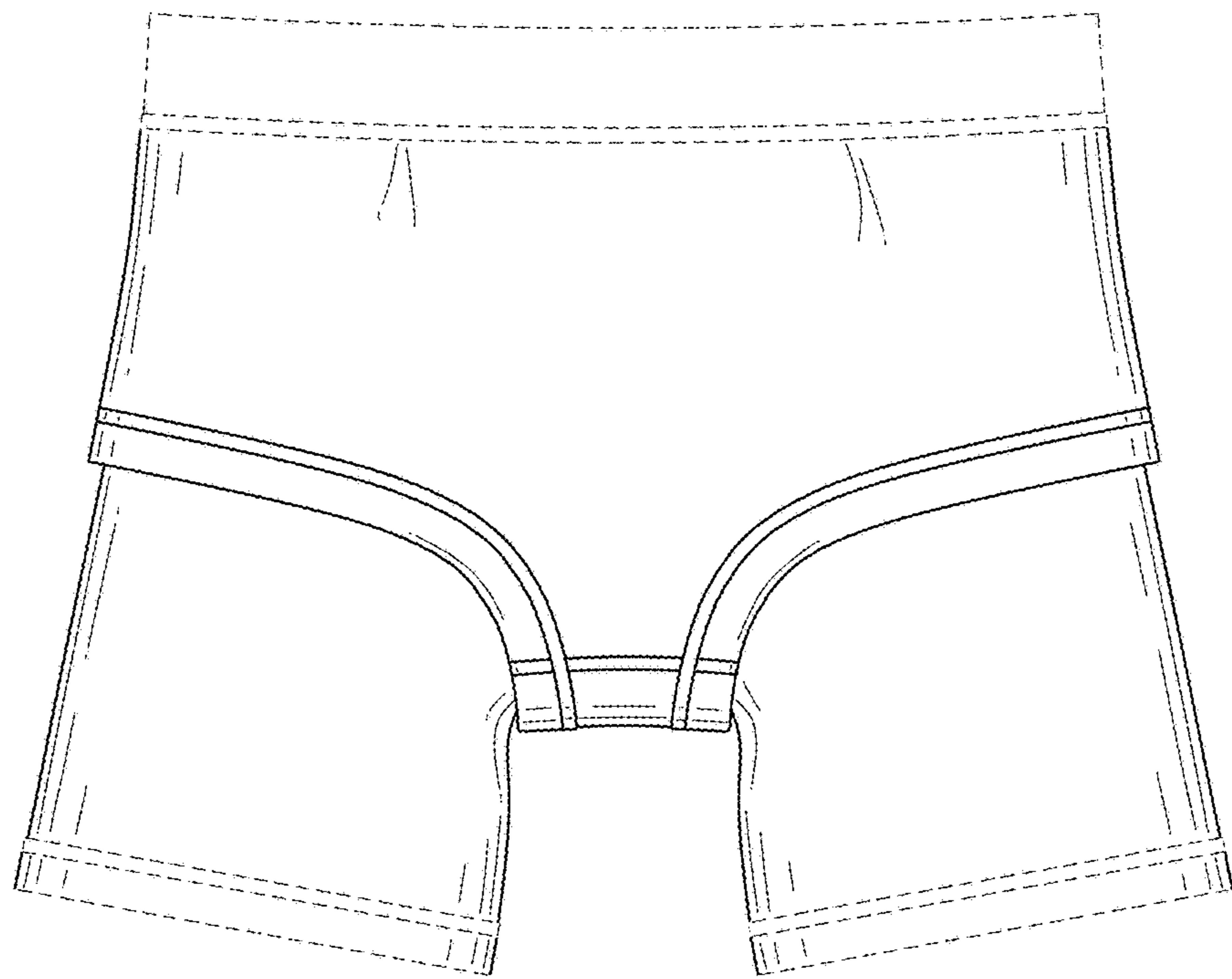

FIG. 21



FIG. 22



FIG. 23

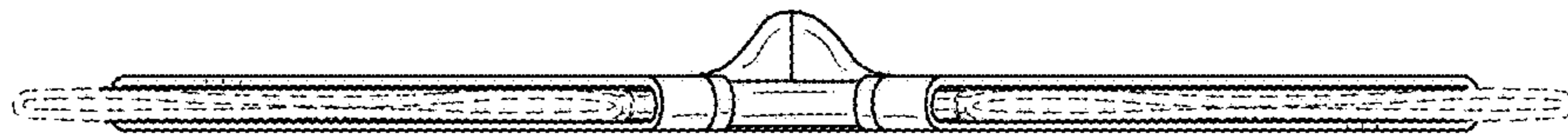

FIG. 24