

US00D864469S

(12) **United States Design Patent**
Sperling

(10) **Patent No.:** **US D864,469 S**

(45) **Date of Patent:** **** *Oct. 22, 2019**

(54) **LIGHT FIXTURE**

(71) Applicant: **Maxim Lighting International, Inc.**,
City of Industry, CA (US)

(72) Inventor: **Jacob Sperling**, City of Industry, CA
(US)

(73) Assignee: **Maxim Lighting International, Inc.**,
City of Industry, CA (US)

(*) Notice: This patent is subject to a terminal disclaimer.

(**) Term: **15 Years**

(21) Appl. No.: **29/590,393**

(22) Filed: **Jan. 10, 2017**

(51) **LOC (12) Cl.** **26-99**

(52) **U.S. Cl.**
USPC **D26/144**

(58) **Field of Classification Search**
USPC D26/72, 80-88, 90, 91, 143, 144, 152,
D26/153, 155

CPC F21S 8/04; F21S 8/06; F21S 8/061; F21S
8/063; F21S 8/065

See application file for complete search history.

(56) **References Cited**

U.S. PATENT DOCUMENTS

D40,296 S *	10/1909	Schneider	D26/84
D40,297 S *	10/1909	Schneider	D26/84
D56,062 S *	8/1920	Gosling	D26/152
D71,966 S *	2/1927	Friedman	D26/81
D75,047 S *	5/1928	Rosenblatt	D26/84
D75,069 S *	5/1928	Rosenblatt	D26/81

D85,444 S *	10/1931	Primakow	D26/84
D112,843 S *	1/1939	Manning	D26/86
D226,532 S *	3/1973	Ishii	D26/84
D236,367 S *	8/1975	Estell	D26/84
D238,506 S *	1/1976	Loveless	D26/84
4,064,427 A *	12/1977	Hansen	F21S 8/065 362/96
D361,858 S *	8/1995	Pickett	D26/84
D372,552 S *	8/1996	Porter	D26/81
D483,514 S *	12/2003	Cuevas	D26/81
D705,475 S *	5/2014	Kitts	D26/81
D711,578 S *	8/2014	Naddeo	D26/81
D779,102 S *	2/2017	Garraton	D26/81
2012/0257388 A1 *	10/2012	Bracher	F21S 8/061 362/249.01

* cited by examiner

Primary Examiner — Clare E Heflin

(74) *Attorney, Agent, or Firm* — Polsinelli PC; Adam C. Rehm

(57) **CLAIM**

The ornamental design for a light fixture, as shown and described.

DESCRIPTION

FIG. 1 is a front, top, right side perspective view of a light fixture according to the new design;
 FIG. 2 is a front side elevation view thereof;
 FIG. 3 is a rear side elevation view thereof;
 FIG. 4 is a left side elevation view thereof;
 FIG. 5 is a right side elevation view thereof;
 FIG. 6 is a top plan view thereof;
 FIG. 7 is a bottom plan view thereof; and,
 FIG. 8 is a front, bottom, right side perspective view thereof.
 The broken lines shown on the drawings depict portions of the light fixture that form no part of the claimed design.

1 Claim, 8 Drawing Sheets

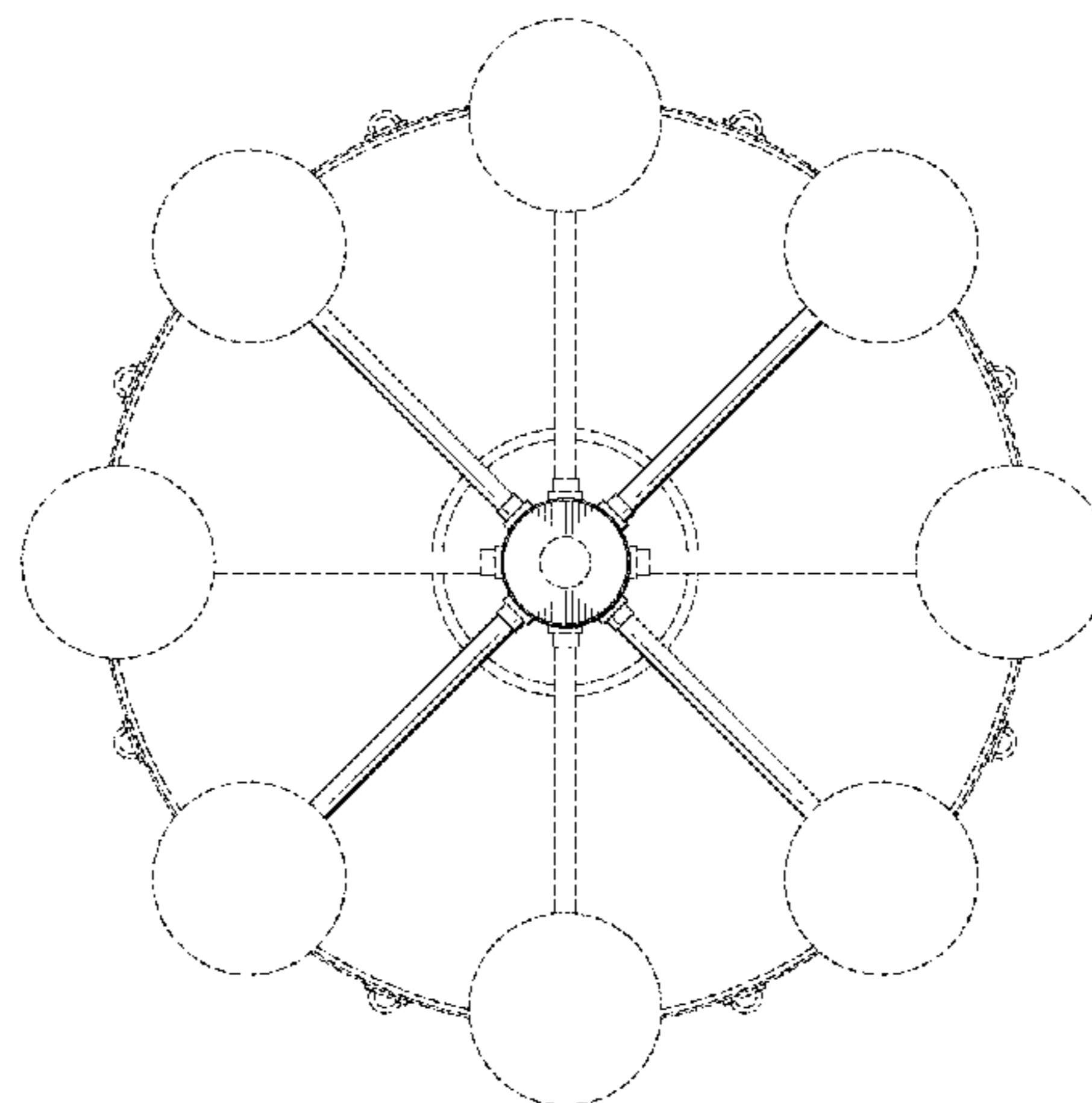
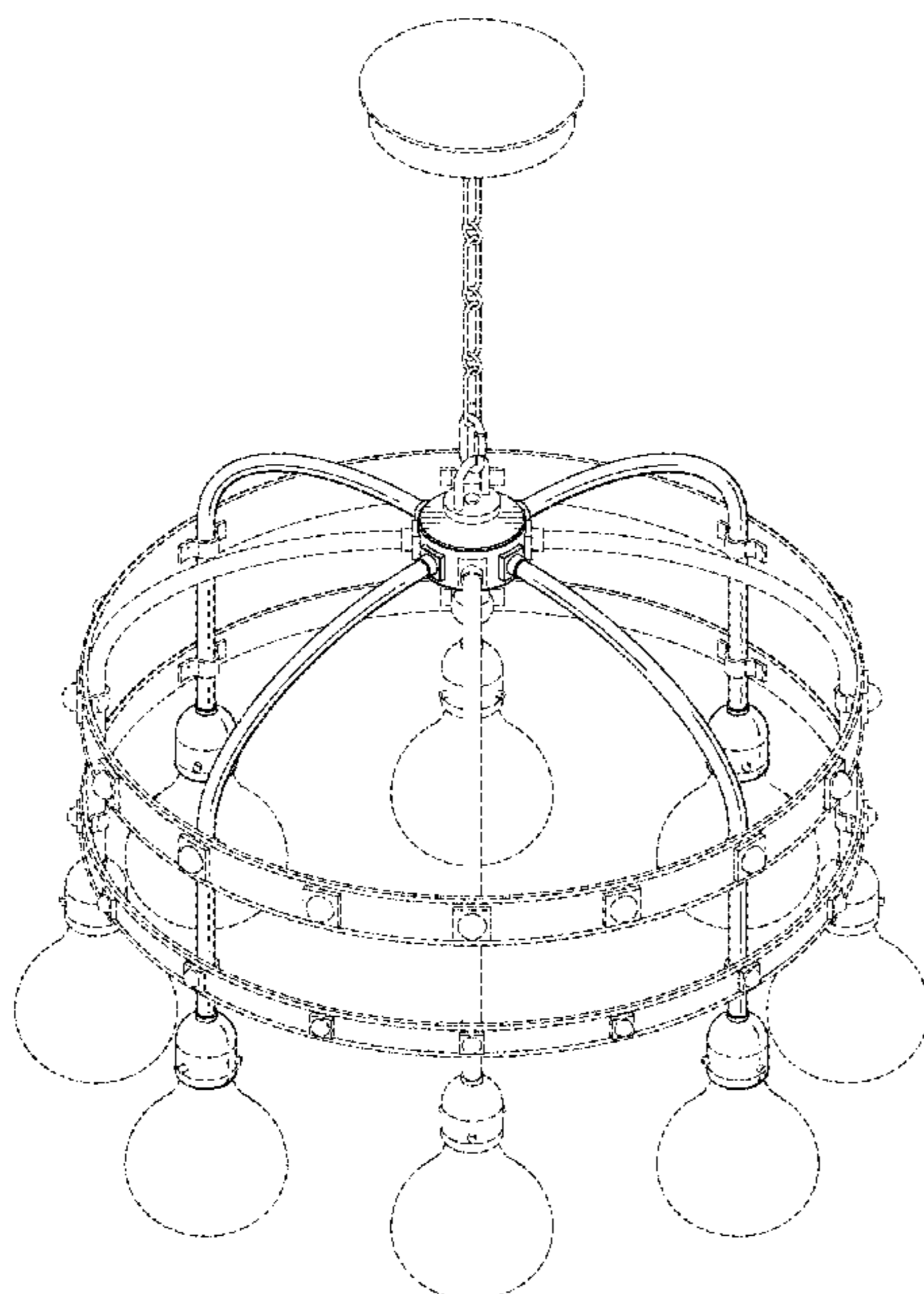
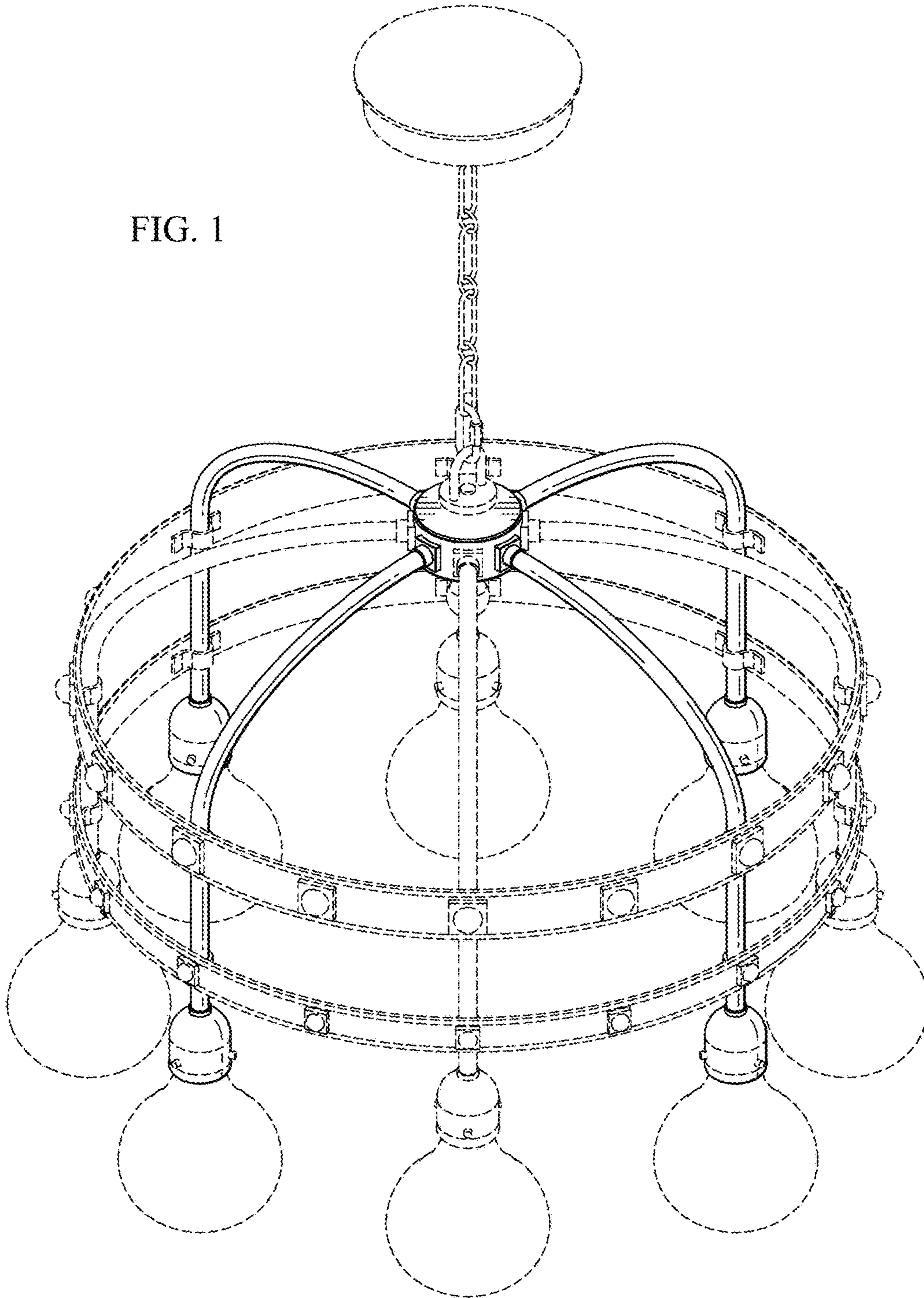

FIG. 1



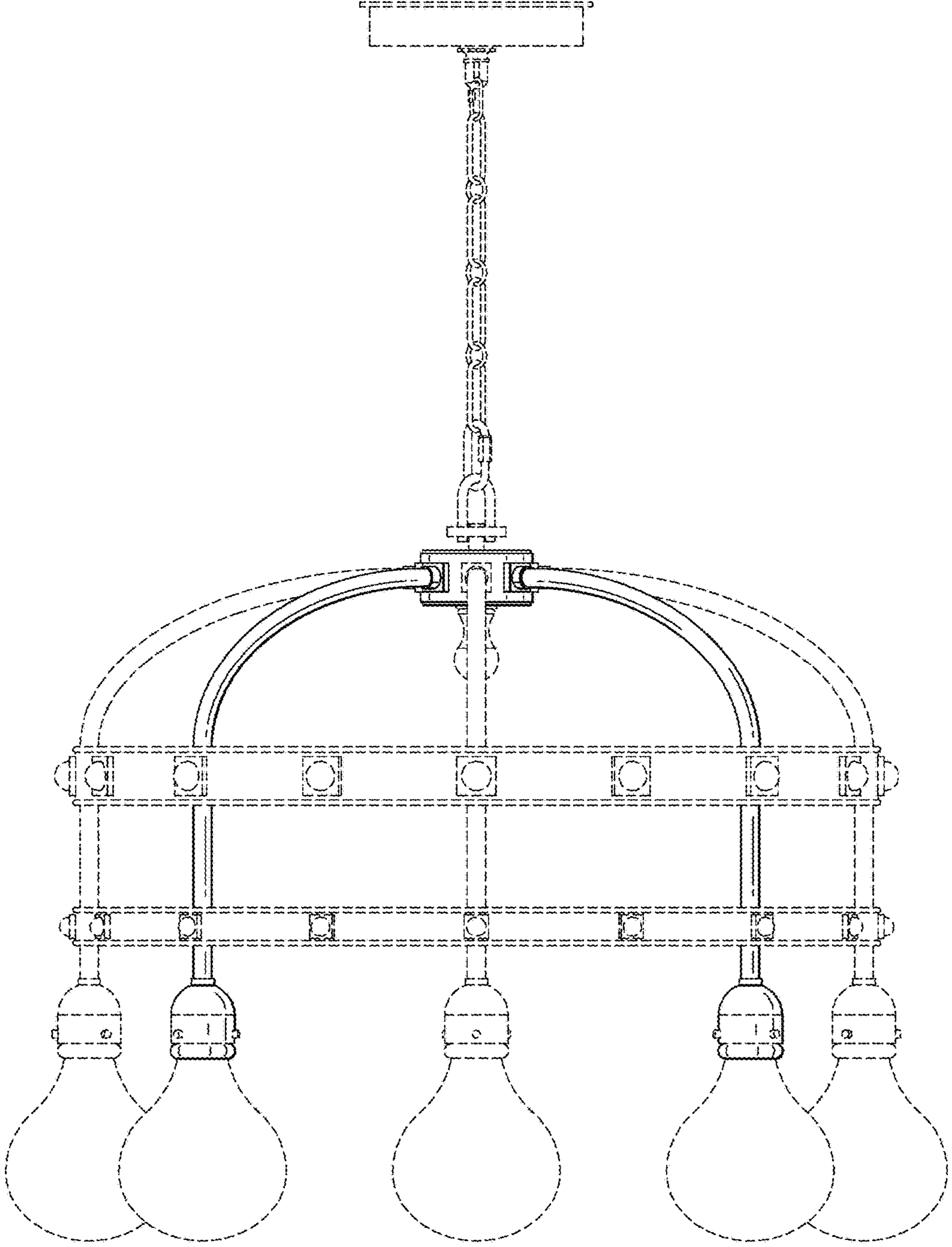

FIG. 2

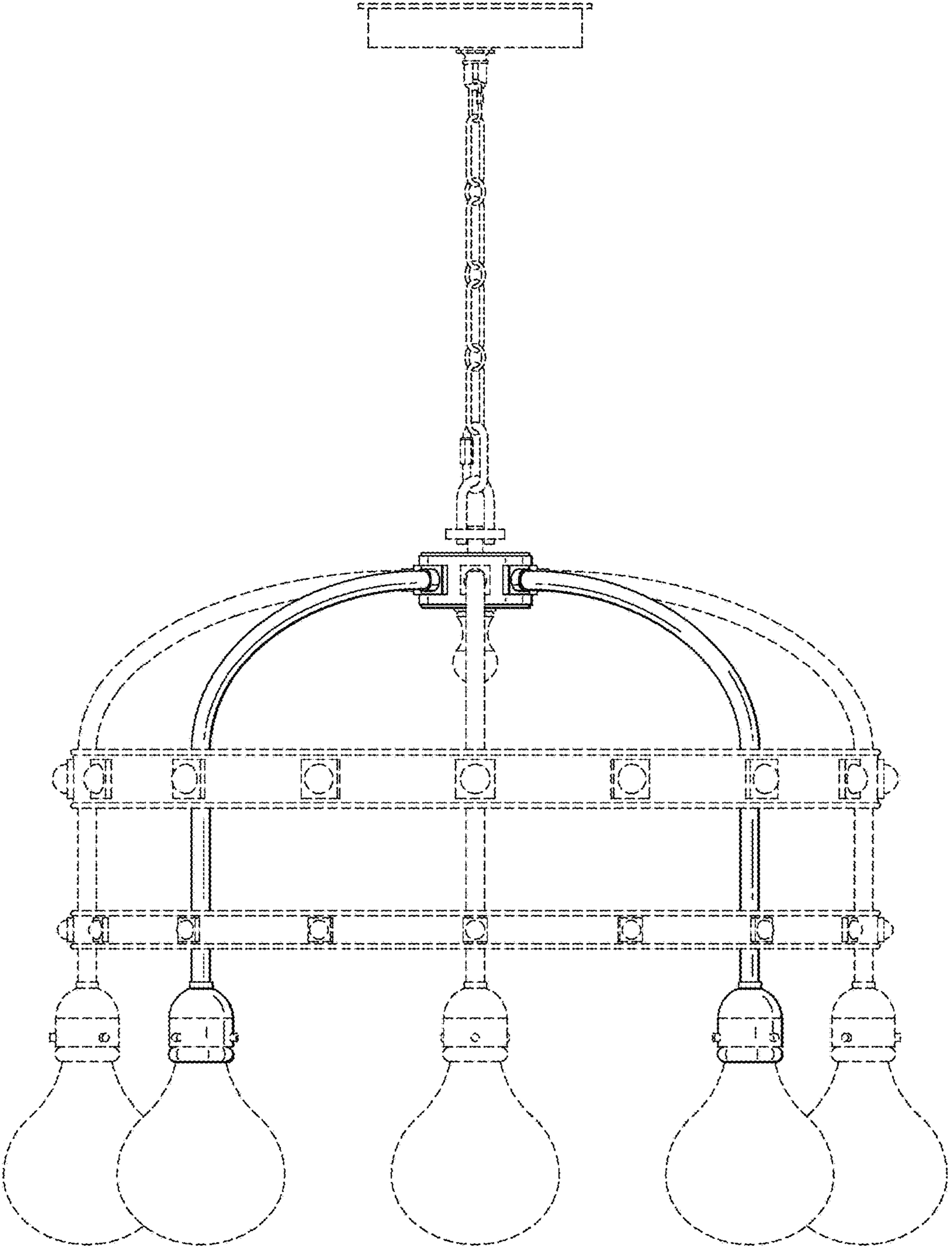

FIG. 3

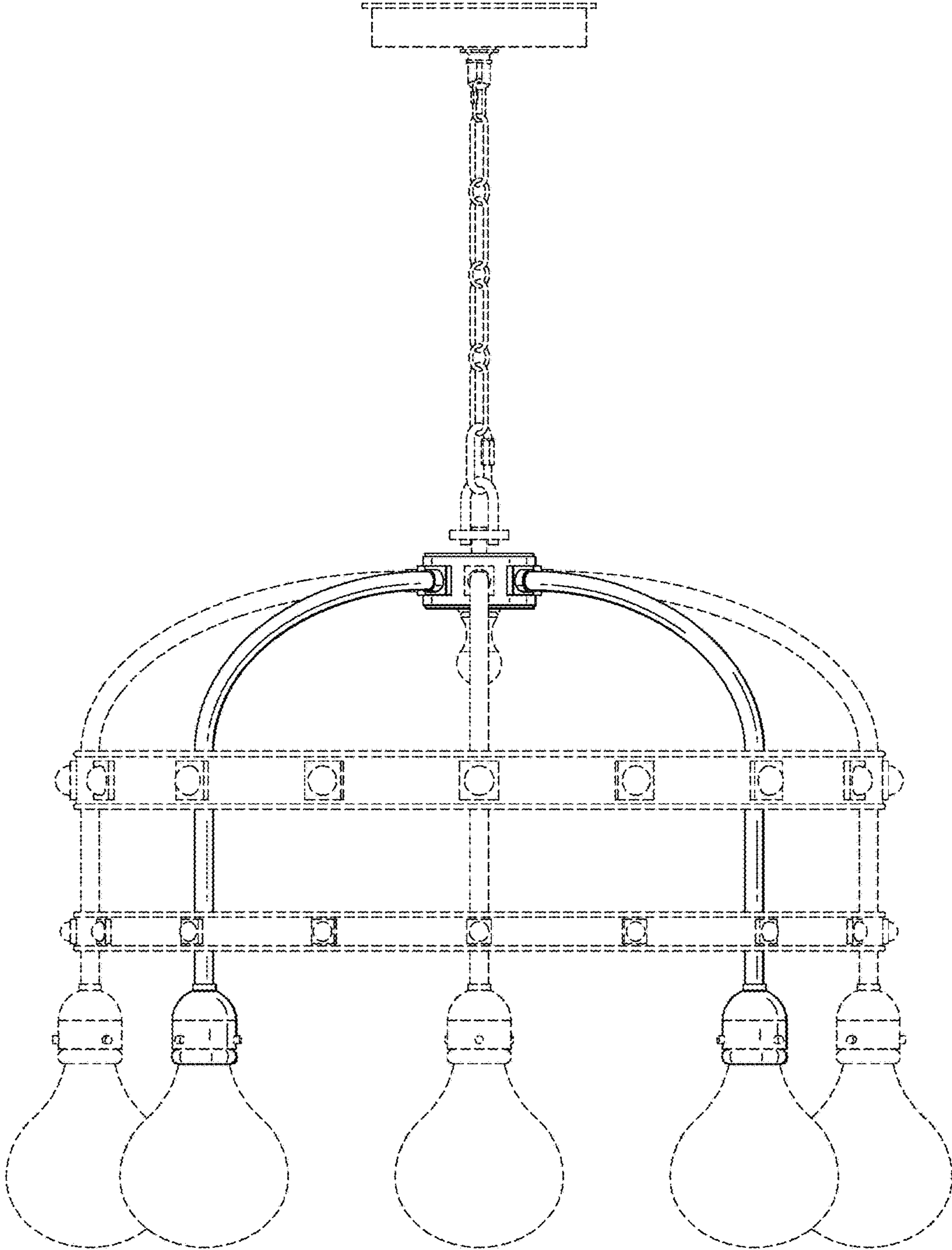

FIG. 4

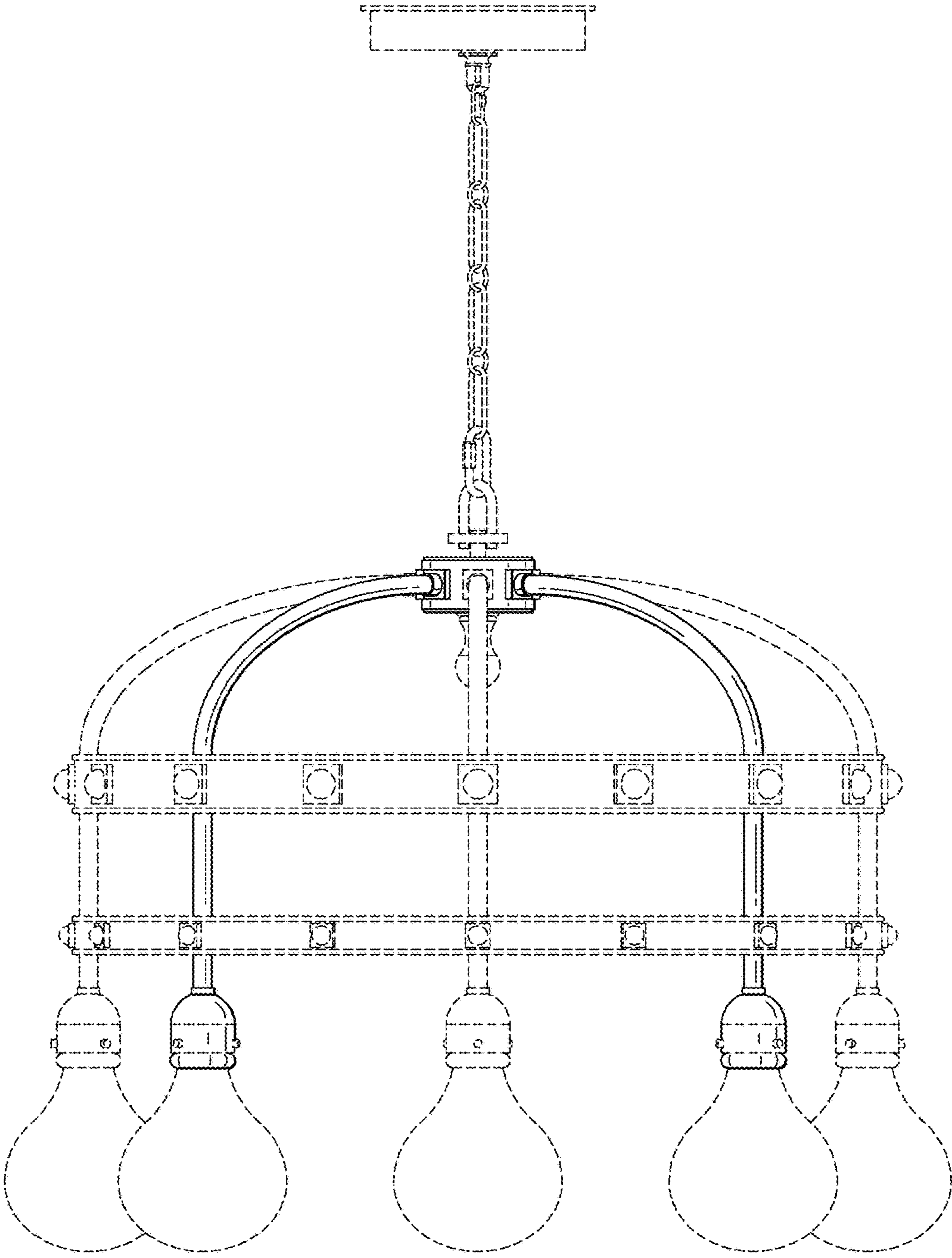

FIG. 5

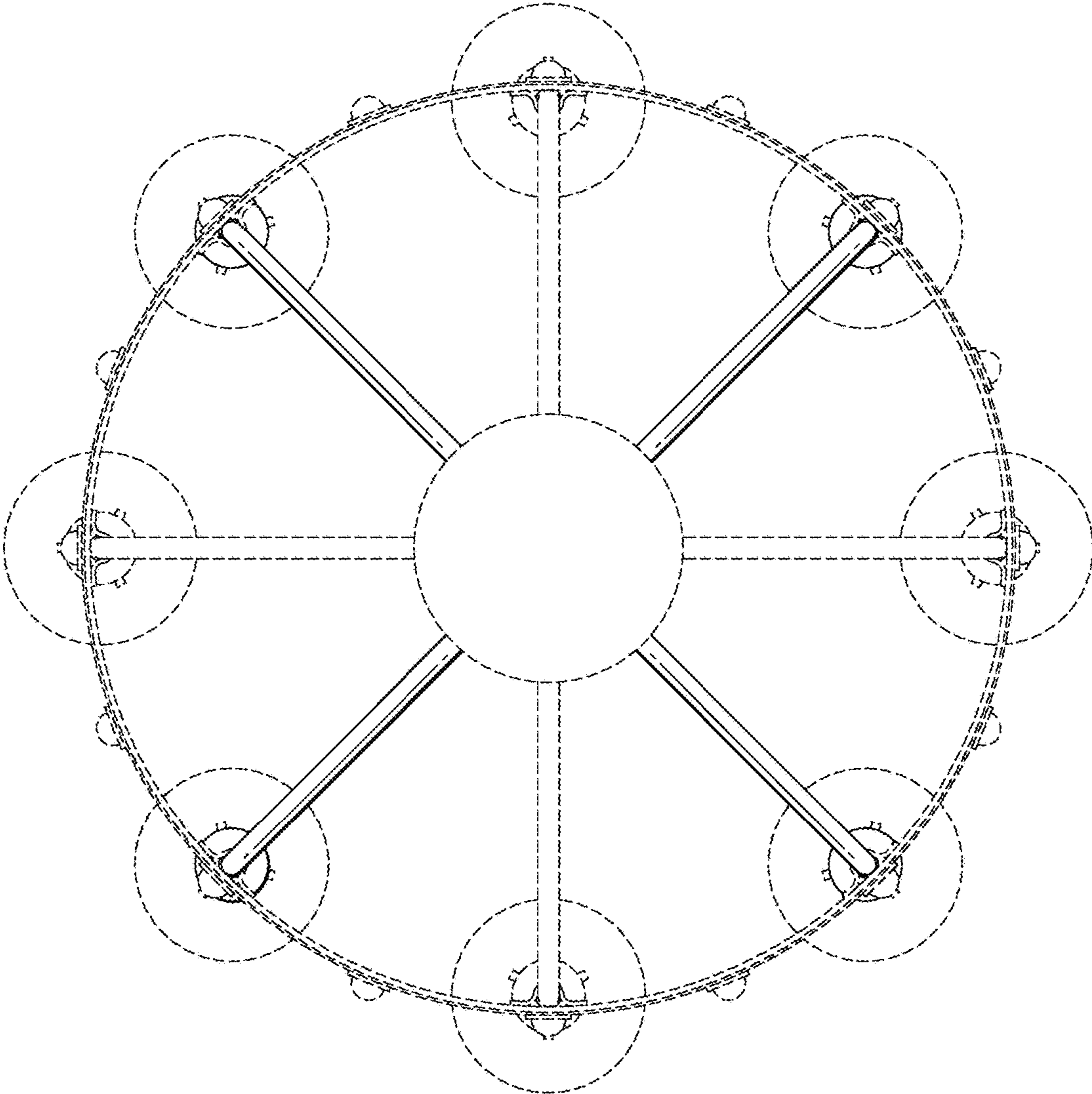

FIG. 6

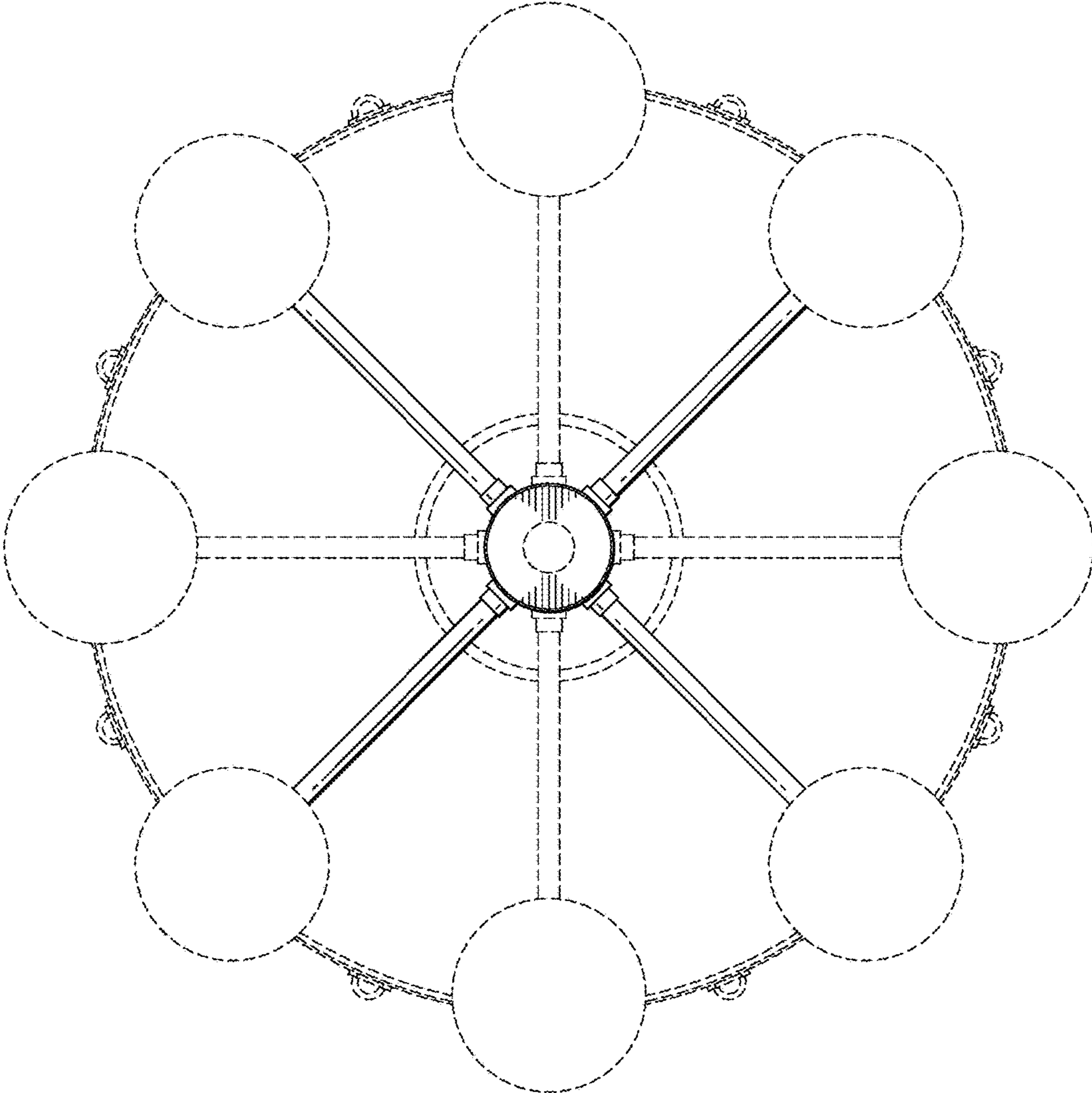

FIG. 7

FIG. 8

