

US00D864195S

(12) **United States Design Patent** (10) **Patent No.:** **US D864,195 S**
Wei (45) **Date of Patent:** **** Oct. 22, 2019**

(54) **GRAPHIC TABLET**
(71) Applicant: **Luo Wei**, Guangdong (CN)
(72) Inventor: **Luo Wei**, Guangdong (CN)
(73) Assignee: **SHENZHEN HUION ANIMATION TECHNOLOGY CO. LTD.**, Shenzhen, Guangdong (CN)
(**) Term: **15 Years**

D629,787 S * 12/2010 Lee D14/203.3
D648,723 S * 11/2011 Harper D14/390
D649,190 S 11/2011 Goodall
D663,287 S * 7/2012 Kim D14/218
D666,620 S * 9/2012 Harper D14/448
D670,286 S 11/2012 Akana et al.
D689,491 S * 9/2013 Halsinger D14/389
D695,410 S * 12/2013 Becker D14/371
D698,384 S * 1/2014 Cruz D18/4.4
D708,622 S * 7/2014 Jonsson D14/485
D716,329 S 10/2014 Wen et al.
D726,724 S * 4/2015 Wahlqvist D14/390

(Continued)

(21) Appl. No.: **29/576,738**
(22) Filed: **Sep. 7, 2016**
(51) **LOC (12) Cl.** **14-02**
(52) **U.S. Cl.**
USPC **D14/341**
(58) **Field of Classification Search**
USPC D14/341–347, 420, 426, 129–130, 496,
D14/138, 138 G, 138 R, 138 AA, 138 AB,
D14/138 C, 139, 248, 203.1–203.8,
D14/388–389, 140–142, 374, 356, 257,
D14/299, 358, 137, 240, 129–130;
D10/104.4, 65; D21/324, 329, 332
CPC G06F 1/1626; G06F 1/1613; G06F
2200/1633; G06F 3/0488; G06F 3/04886;
G06F 3/044; G06F 3/0412; G06F 3/0416;
H04B 1/3833; H04M 1/6091; H04M
1/7253; H01M 2250/02
See application file for complete search history.

OTHER PUBLICATIONS

Huion Inspiroy G10T, announced Jul. 15, 2016 [online], [retrieved Sep. 17, 2018]. Available from Internet, URL: <<https://www.deviantart.com/huion/journal/HUION-INSPIROY-G10T-621764903>> (Year: 2016).*

(Continued)

Primary Examiner — Barbara Fox
Assistant Examiner — Dana K Weiland
(74) *Attorney, Agent, or Firm* — Legalforce RAPC
Worldwide

(57) **CLAIM**

The ornamental design for a graphic tablet, as shown and described.

DESCRIPTION

FIG. 1 is a front right perspective view of a graphic tablet showing my new design;
FIG. 2 is a front elevational view thereof;
FIG. 3 is a rear elevational view thereof;
FIG. 4 is a right side elevational view thereof;
FIG. 5 is a left side elevational view thereof;
FIG. 6 is a top plan view thereof; and,
FIG. 7 is a bottom plan view thereof.

1 Claim, 5 Drawing Sheets

(56) **References Cited**
U.S. PATENT DOCUMENTS
D313,409 S 1/1991 Chowdhree et al.
D502,944 S * 3/2005 Kawami D14/336
D504,889 S 5/2005 Andre et al.
D541,800 S * 5/2007 Ponnert D14/388
D602,488 S * 10/2009 Jiang D14/341
D604,845 S * 11/2009 Hibi D24/107
D624,042 S * 9/2010 Lee D14/138 AD
D629,400 S * 12/2010 Harper D14/390

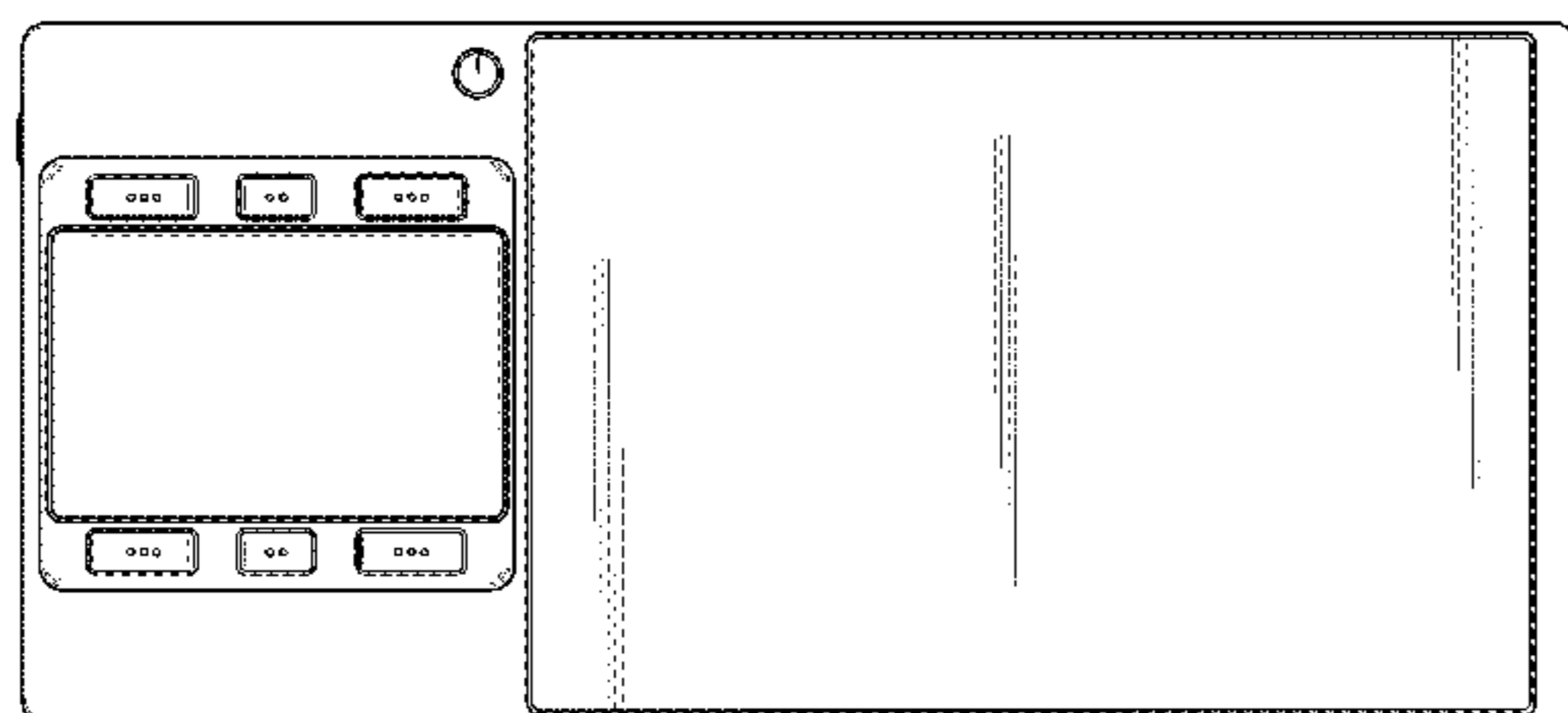

(56)

References Cited

U.S. PATENT DOCUMENTS

D744,484	S *	12/2015	Huebner	D14/389
9,384,672	B1 *	7/2016	Zehr	B42D 3/123
D762,872	S *	8/2016	Chen	D24/215
D789,532	S *	6/2017	Tanaka	D24/138
D801,393	S *	10/2017	Lai	D14/496
D802,588	S *	11/2017	Tao	D14/346
D808,019	S *	1/2018	Amaral	D24/169
D813,408	S *	3/2018	Chen	D24/215
D814,469	S *	4/2018	Rundberg	D14/389
D818,465	S *	5/2018	Mitchell	D14/341
2006/0284848	A1 *	12/2006	Lin	G06F 1/3203 345/169

OTHER PUBLICATIONS

US Trademark Serial No. 86198474; Word Mark—Huion.
 US Trademark Serial No. 87081191; Word Mark—Gaomon.
 US Trademark Serial No. 86557131; Word Mark—Kenting.
 US Trademark Serial No. 86502803; Word Mark—Litup.
 US Trademark Serial No. 87007346; Word Mark—Inspiroy.
 Drawing Pad Tablet by XP-Pen. Found online [Dec. 12, 2016] <https://goo.gl/39MUCj>.
 Multi-Touch Graphic Tablet by Wacom. Found online [Dec. 12, 2016] <https://goo.gl/QY3hal>.
 Graphic Tablet by Huion. Found online [Dec. 12, 2016] <http://www.parkablogs.com/sites/default/files/huion-giano-wh1409-02.jpg>.
 Wireless Digital Graphic Tablet by Huion. Found online [Dec. 12, 2016] <https://s-media-cache-ak0.pinimg.com/236x/b1/32/57/b132572e35127d5780419103189e48d8.jpg>.
 Drawing Tablet by Huion. Found online [Dec. 12, 2016] <http://g-ec2.images-amazon.com/images/G/31/electronics/drawtab.01.jpg>.
 Graphic Drawing Tablet by XP-Pen. Found online [Dec. 12, 2016]

<http://image.dhgate.com/0x0/f2/albu/g2/M00/68/77/rBVaG1bD6zWARYdDAAUT3kCKzU8412.jpg>.
 Graphic Tablet by Wacom. Found online [Dec. 12, 2016] <https://goo.gl/d911mz>.
 Graphic Tablet by Genius G_PEN. Found online [Dec. 12, 2016] <https://i.ytimg.com/vi/paACrphXgKI/maxresdefault.jpg>.
 Graphic Tablet by Apple. Found online [Dec. 12, 2016] <https://goo.gl/F9UNwZ>.
 Splash Pen Tablet by Wacom Bamboo. Found online [Dec. 12, 2016] <http://i.ebayimg.com/imges/g/~KUAAOSw2XFUdA~~/s-1300.jpg>.
 Graphic Tablet by Bamboo. Found online [Dec. 12, 2016] https://upload.wikimedia.org/wikipedia/commons/0/0a/Wacom_Bamboo_Capture_tablet_and_pen.jpg.
 Graphic Tablet by Huion. Found online [Dec. 12, 2016] <http://www.huion-tablet.com/upload/allimg/160414/1-1604141535520-L.jpg>.
 Graphic Pen Tablet by Huion. Found online [Dec. 12, 2016] <https://cdn.fstoppers.com/styles/full/s3/media/2016/02/22/cheap-graphics-tablet.jpg>.
 Graphic Tablet by Huion. Found online [Dec. 12, 2016] http://s3.amazonaws.com/img/tnt/feee680/d836_1.jpg.
 K58 pen tablet by Huion. Found online [Dec. 12, 2016] <http://conceptartempire.com/images/07/938/huion-k58-drawing-tablet-photo.jpg>.
 S56K Graphic Tablet by Gaomon. Found online [Dec. 12, 2016] <https://goo.gl/6a1PDC>.
 M10K Graphic Tablet by Gaomon. Found online [Dec. 12, 2016] <http://www.gaomon.net/upload/161020/1-161020095J3G4.jpg>.
 USB Art Design Graphics Drawing Tablet Board by Huion. Found online [Dec. 12, 2016] https://images-na.ssl-images-amazon.com/images/1/31316YHmPQL._SY300_.jpg.
 USB Art Design Graphics Drawing Tablet Digital Pen Signature Pad by Huion. Found online [Dec. 12, 2016] https://images-na.ssl-images-amazon.com/images/1/31ZwEZCimQL._SY355_.jpg.

* cited by examiner

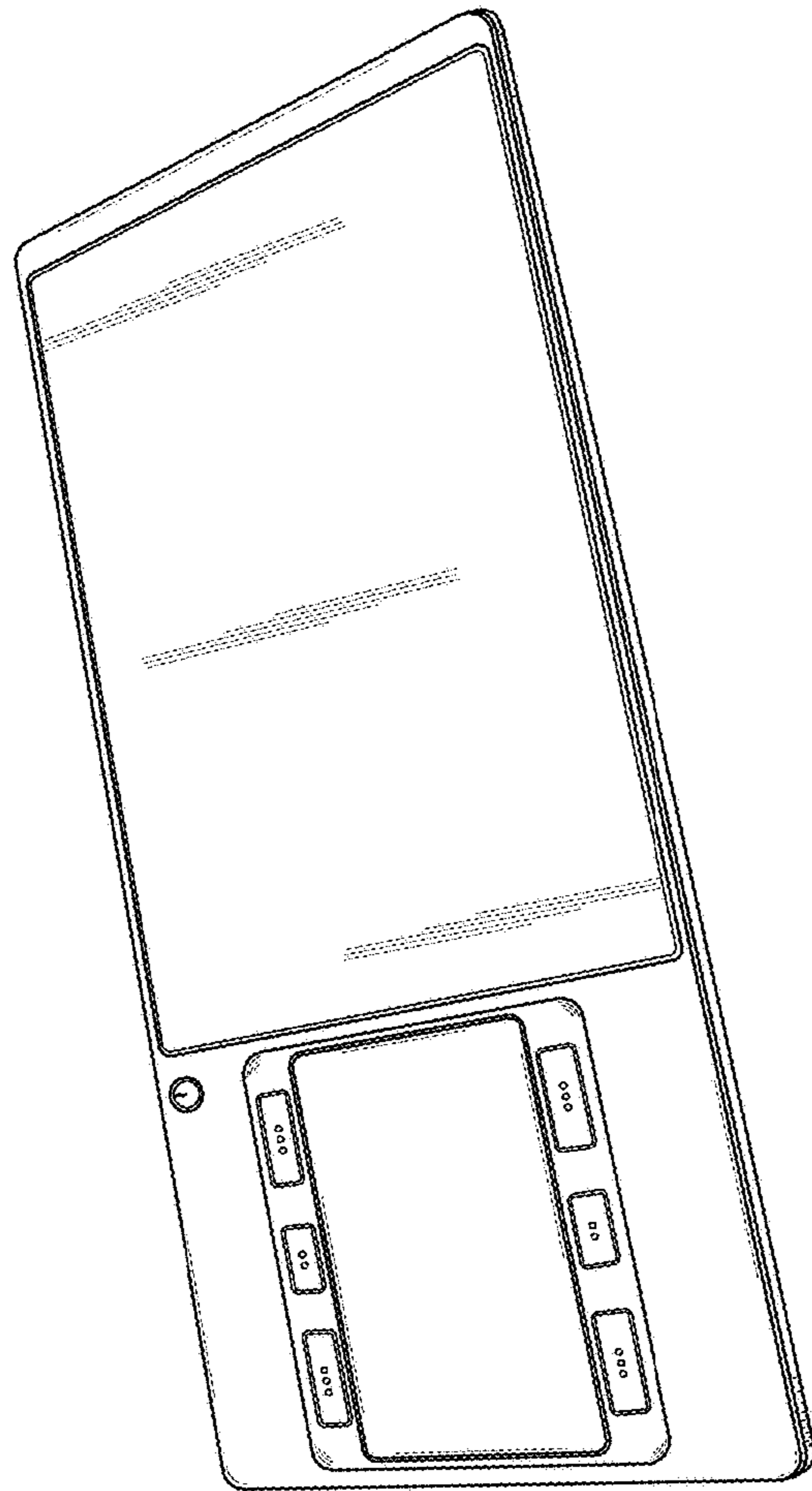

FIG. 1

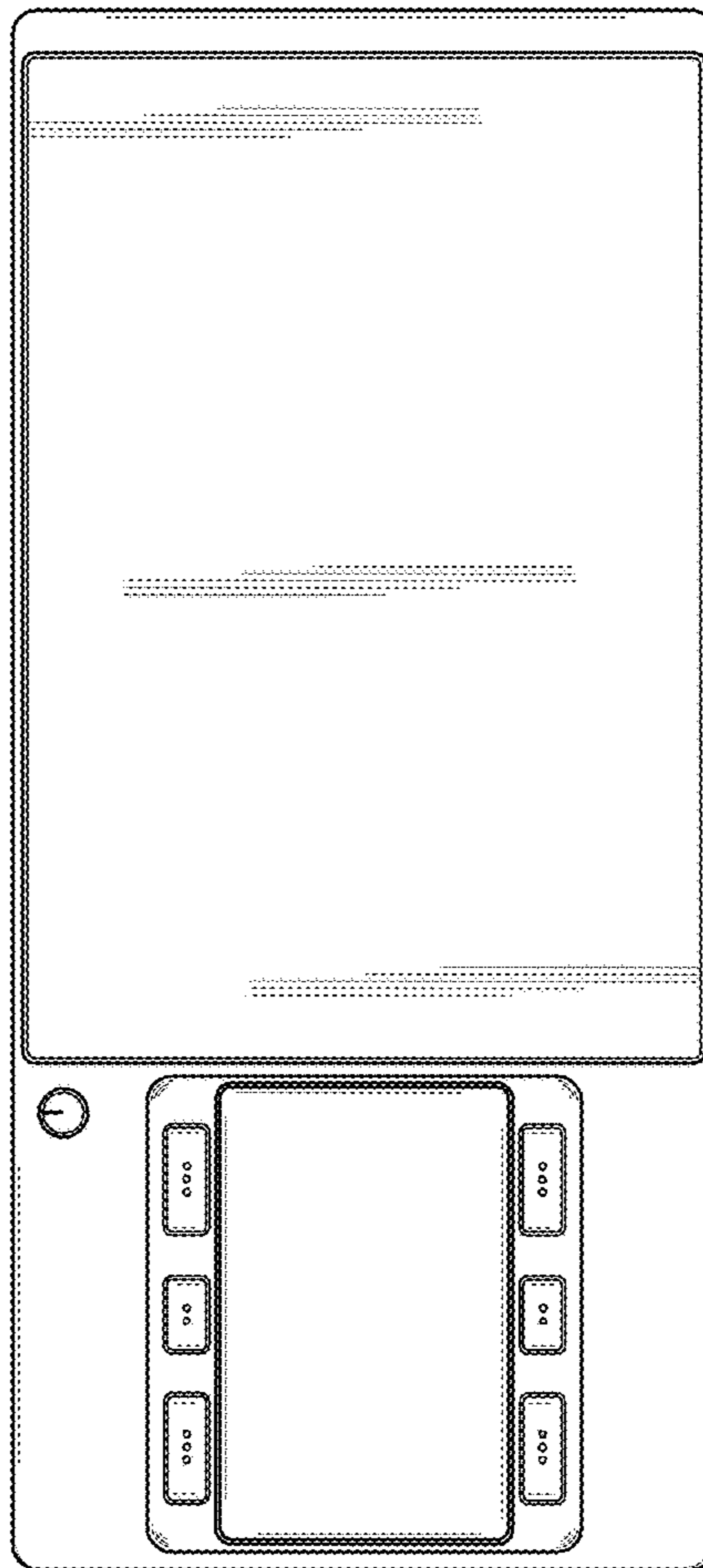

FIG. 2

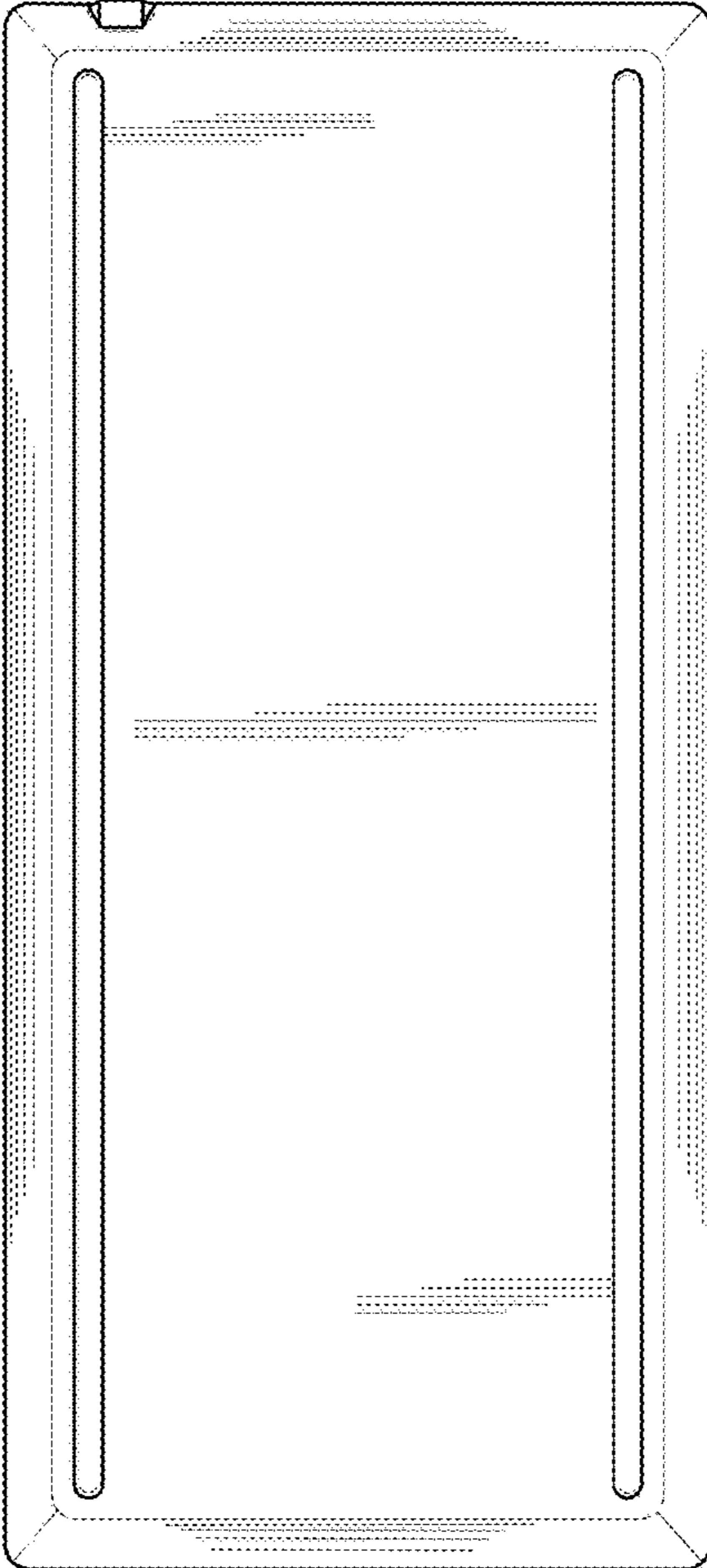

FIG. 3



FIG. 4

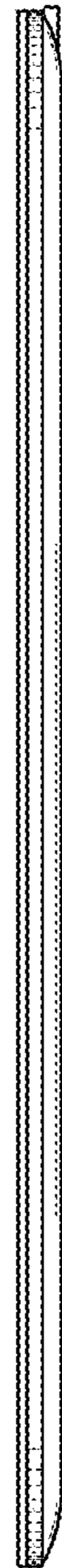

FIG. 5

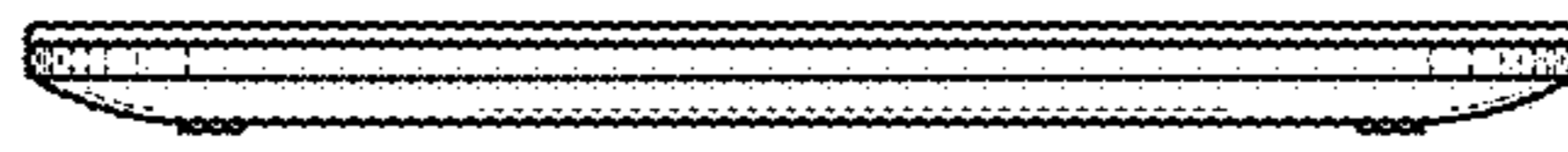

FIG. 6

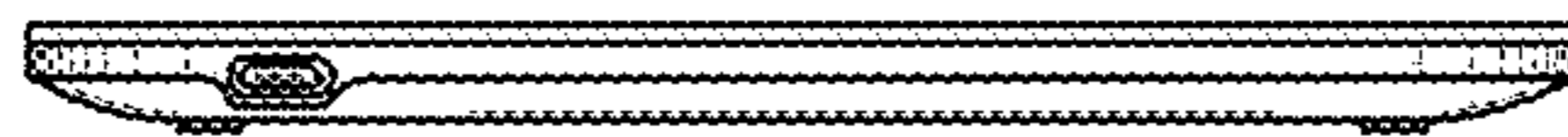

FIG. 7