



US00D864180S

(12) **United States Design Patent**  
**Kim**

(10) **Patent No.:** **US D864,180 S**  
(45) **Date of Patent:** **\*\* Oct. 22, 2019**

- (54) **CASE FOR ELECTRONIC DEVICE**
- (71) Applicant: **SPIGEN KOREA CO., LTD.**, Seoul (KR)
- (72) Inventor: **Dae-Young Kim**, Seoul (KR)
- (73) Assignee: **SPIGEN KOREA CO., LTD.**, Seoul (KR)
- (\*\*) Term: **15 Years**
- (21) Appl. No.: **29/622,466**
- (22) Filed: **Oct. 17, 2017**

**Related U.S. Application Data**

- (63) Continuation of application No. 29/518,914, filed on Feb. 27, 2015, now Pat. No. Des. 803,206.
- (51) **LOC (12) Cl.** ..... **14-03**
- (52) **U.S. Cl.**  
USPC ..... **D14/250**
- (58) **Field of Classification Search**  
USPC ..... D14/143, 189, 203.2–203.7, 217, 238.1, D14/240, 248, 250–253, 341, 345–347,  
(Continued)

**References Cited**

**U.S. PATENT DOCUMENTS**

- D565,291 S 4/2008 Brandenburg et al.
  - D609,463 S 2/2010 Bullen
- (Continued)

**OTHER PUBLICATIONS**

Transformer Slim Hard Shell Holster Case with Kickstand and Belt Clip, Earliest Review Sep. 25, 2014, [Visited Online May 25, 2018], <https://www.i-blason.com/transformer-slim-hard-shell-case-holster-combo-with-kickstand-and-locking-belt-swivel-clip-for-apple-iphone-6-plus.html>.\*

(Continued)

*Primary Examiner* — Eric L Goodman  
*Assistant Examiner* — Amy C Wierenga  
(74) *Attorney, Agent, or Firm* — Heedong Chae; Lucem, PC

(57) **CLAIM**

The ornamental design for a case for electronic device, as shown and described.

**DESCRIPTION**

FIG. 1 is a front perspective view of a case for electronic device showing my new design;  
 FIG. 2 is a rear perspective view thereof;  
 FIG. 3 is a front elevational view thereof;  
 FIG. 4 is a rear elevational view thereof;  
 FIG. 5 is a left side elevational view thereof;  
 FIG. 6 is a right side elevational view thereof;  
 FIG. 7 is a top plan view thereof;  
 FIG. 8 is a bottom plan view thereof;  
 FIG. 9 is a rear perspective view of the case with a support leg extended;  
 FIG. 10 is a front exploded view of the case, showing an inner shell, the support leg, and an outer frame of the case;  
 FIG. 11 is a rear exploded view of the case, showing an inner shell, the support leg, and an outer frame of the case;  
 FIG. 12 is a front perspective view of the inner shell of the case;  
 FIG. 13 is a rear perspective view of the inner shell of the case;  
 FIG. 14 is a front perspective view of the support leg of the case;  
 FIG. 15 is a rear perspective view of the support leg of the case;  
 FIG. 16 is a front perspective view of the outer frame of the case; and,  
 FIG. 17 is a rear perspective view of the outer frame of the case.

The dashed broken lines in the drawings depict portions of the case for electronic device that form no part of the claimed design. The dash-dot broken lines define the boundaries of the claim that form no part of the claimed design.

**1 Claim, 17 Drawing Sheets**

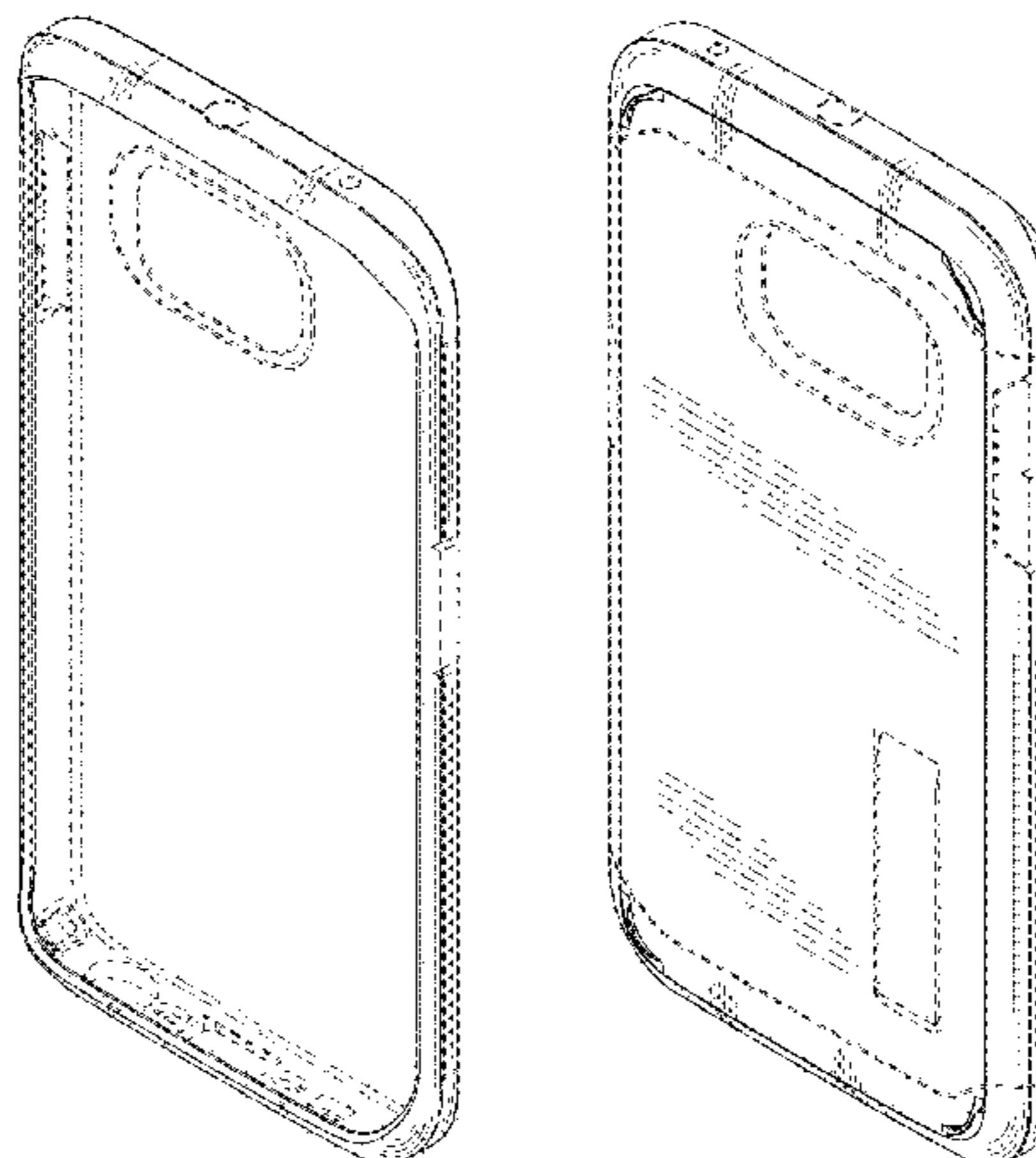

(58) **Field of Classification Search**

USPC ..... D14/439–440, 447, 496; D13/108;  
D3/201, 218, 269, 273  
CPC ..... A45C 11/00; A45C 2011/002; A45C  
2011/003; H04M 1/0202; H04M 1/0283;  
H04M 1/185

See application file for complete search history.

(56) **References Cited**

U.S. PATENT DOCUMENTS

D621,822 S	8/2010	Richardson et al.	
D624,064 S	9/2010	Esposito	
D624,908 S	10/2010	Huskinson	
D624,910 S	10/2010	Richardson et al.	
D636,387 S	4/2011	Willes et al.	
D659,691 S	5/2012	Kim et al.	
D663,294 S	7/2012	Buxton	
D679,271 S	4/2013	Liu	
D682,260 S	5/2013	Tages et al.	
D684,150 S	6/2013	Goradesky et al.	
D685,361 S	7/2013	Goradesky et al.	
D694,224 S	11/2013	Wooseung	
D694,225 S	11/2013	Yu-Guen	
D696,654 S	12/2013	Lee	
D696,655 S	12/2013	Lee	
D702,220 S	4/2014	Kim	
D704,200 S *	5/2014	Rayner	D14/447
D706,254 S	6/2014	Chang	
D709,871 S	7/2014	Lee et al.	
D714,278 S	9/2014	Case et al.	
D721,685 S	1/2015	Hasbrook et al.	
D721,694 S	1/2015	Lee et al.	
9,185,954 B2	11/2015	Cheung et al.	
D749,594 S	2/2016	Kim et al.	
D763,857 S *	8/2016	Dang	D14/440
D765,067 S	8/2016	Choe et al.	
D771,608 S *	11/2016	Kim	D14/250
D777,155 S *	1/2017	Kim	D14/250
D777,156 S *	1/2017	Kim	D14/250
D778,897 S *	2/2017	Kim	D14/250
D780,165 S *	2/2017	Lee	D14/250
D780,167 S *	2/2017	Tien	D14/250
D781,840 S *	3/2017	Kim	D14/250
D785,615 S *	5/2017	Kim	D14/250
D786,846 S	5/2017	Kim et al.	
D786,851 S *	5/2017	Kim	D14/250
D787,492 S *	5/2017	Kim	D14/250
D787,493 S *	5/2017	Kim	D14/250
D789,344 S *	6/2017	Kim	D14/250
D791,757 S *	7/2017	Kim	D14/250
D795,236 S *	8/2017	Kim	D14/250
D797,094 S *	9/2017	Kim	D14/250
D798,284 S *	9/2017	Kim	D14/250

D798,285 S *	9/2017	Kim	D14/250
D800,713 S *	10/2017	Kim	D14/250
D803,206 S *	11/2017	Kim	D14/250
D808,944 S *	1/2018	Kim	D14/250
D808,945 S *	1/2018	Yeo	D14/250
9,866,663 B2 *	1/2018	Kim	H04M 1/04
D815,085 S *	4/2018	Kim	D14/250
D845,944 S *	4/2019	Gronewoller	D14/250
2009/0017883 A1	1/2009	Lin	
2013/0077211 A1	3/2013	Wang	
2013/0126531 A1	5/2013	Hynecek et al.	
2014/0262854 A1 *	9/2014	Chen	A45C 11/00 206/45.24
2014/0262855 A1	9/2014	Gandhi et al.	
2014/0360892 A1	12/2014	Lin	
2015/0156297 A1	6/2015	Crawford et al.	
2016/0028430 A1	1/2016	Crawford et al.	

OTHER PUBLICATIONS

Spigen Smasung Case; Lazada <https://www.lazada.com.ph/products/south-korea-spigen-samsung-s8s8plus-phone-case-new-style-cool-dull-polish-protective-case-samsung-s8-silicone-cover> (Year: 2018).\*

“Spigen Tough Armor Designed for Apple iPad Mini 3 Case, iPad Mini 2 Case, iPad Mini Case—Metal Slate”, <https://www.amazon.com/dp/B00FRVDVXX>, Earliest review date of Dec. 27, 2013, Downloaded on Jan. 15, 2019.

“Spigen Tough Armor iPhone SE/5S/5 Case with Extreme Heavy Duty Protection and Air Cushion Technology for iPhone SE/iPhone 5S/iPhone 5—Metal Slate”, <https://www.amazon.com/dp/B00DMKGPP4>, Earliest review date of Aug. 1, 2013, Downloaded on Aug. 9, 2018.

Spigen Slim Armor iPhone SE / 5S / 5 Case with Advanced Drop Protection and Dual Layer Design for iPhone SE / iPhone 5S / iPhone 5—Metal Slate, <https://www.amazon.com/dp/B00DD62R40>, Earliest review date of Dec. 14, 2012, Downloaded on Sep. 18, 2018.

“Spigen Slim Armor View Galaxy S4 Case with Automatic Sleep / Wake Feature for Galaxy S4 2013—Soul Black”, <https://www.amazon.com/Spigen-Armor-Galaxy-Automatic-Feature/dp/B00DCCVS5Y>, Earliest review date of Mar. 18, 2013, Downloaded on Feb. 19, 2019.

“Spigen Slim Armor Nexus 5 Case with Air Cushion Technology and Hybrid Drop Protection for Nexus 5 2013—Infinity White”, <https://www.amazon.com/Spigen-Cushion-Technology-Hybrid-Protection/dp/B00EV8Y7XI>, Earliest review date of Nov. 4, 2013, Downloaded on Jan. 16, 2019.

“Spigen Slim Armor View Galaxy S5 Case with Automatic Sleep / Wake Feature for Samsung Galaxy S5 2014—View Smooth White”, <https://www.amazon.com/Spigen-Galaxy-Automatic-Feature-Samsung/dp/B00KGG02EI>, Earliest review date of Jan. 18, 2014, Downloaded on Jan. 16, 2019.

\* cited by examiner



FIG. 1

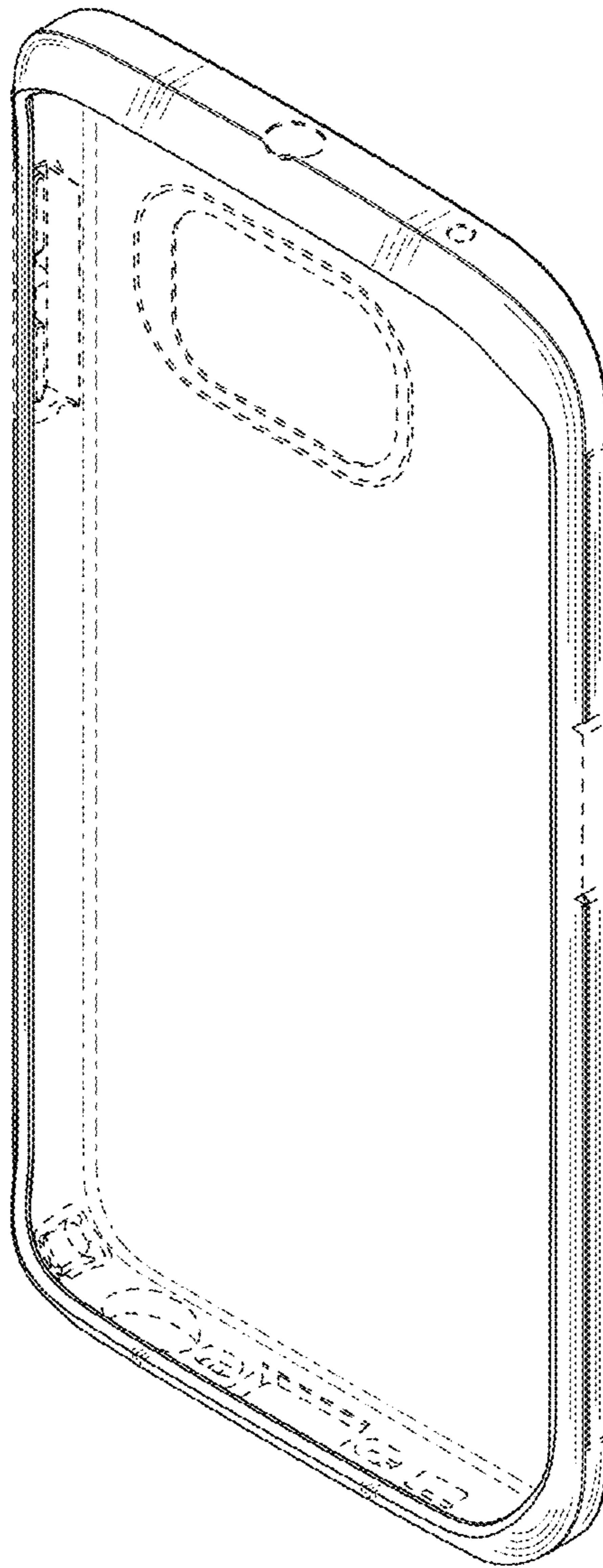

FIG. 2

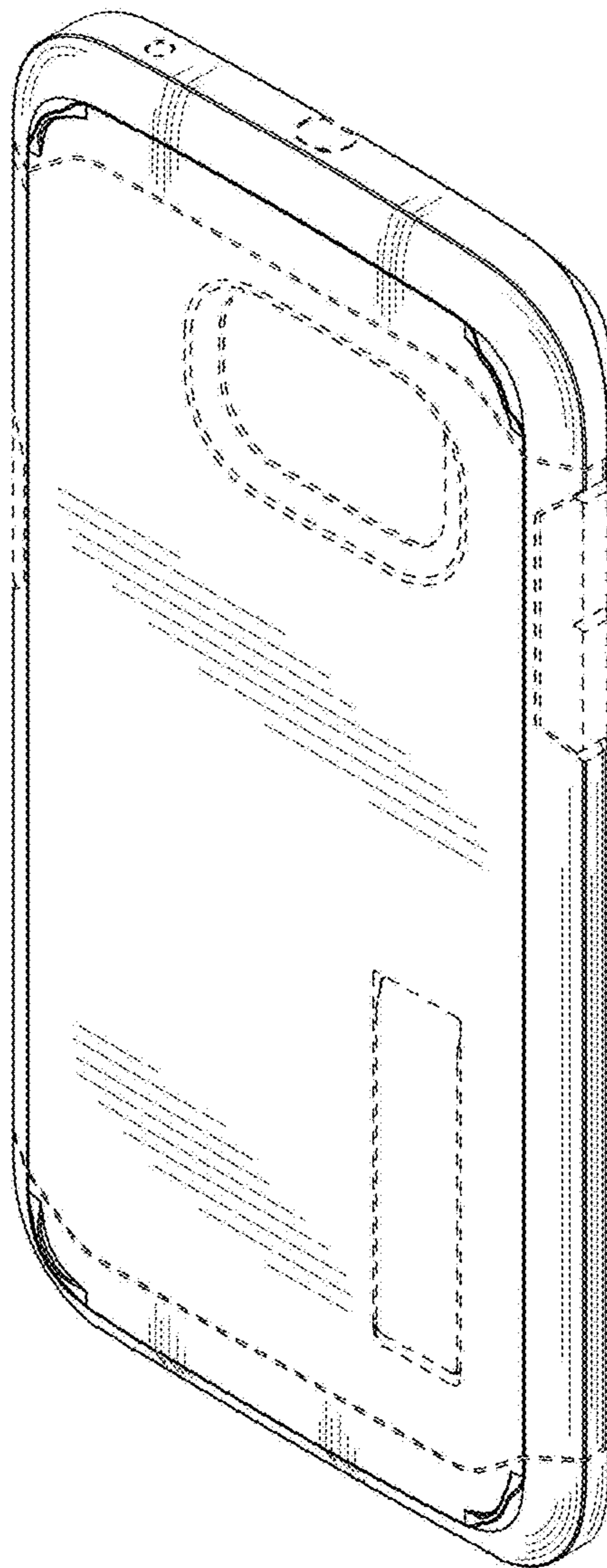

FIG. 3

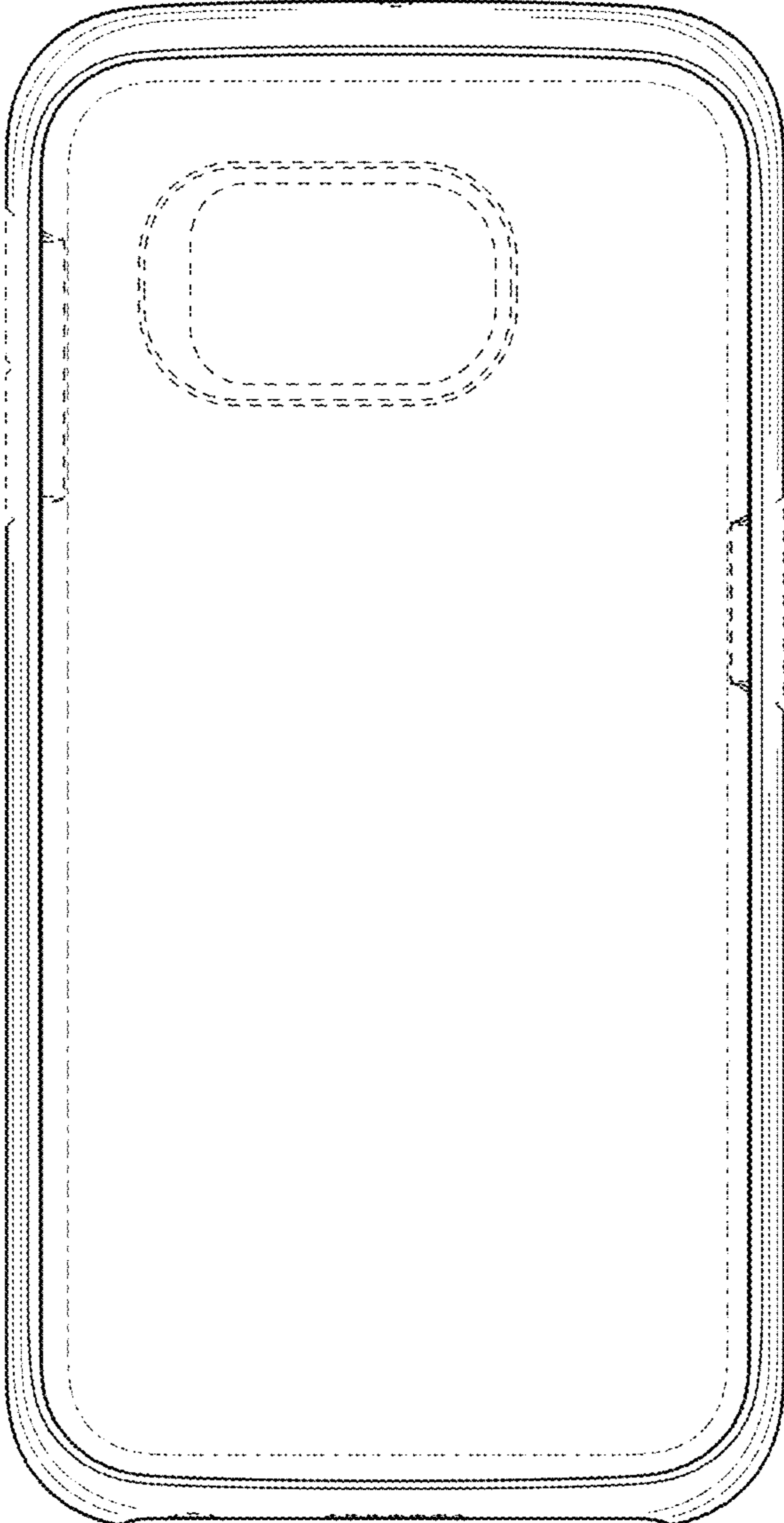

FIG. 4

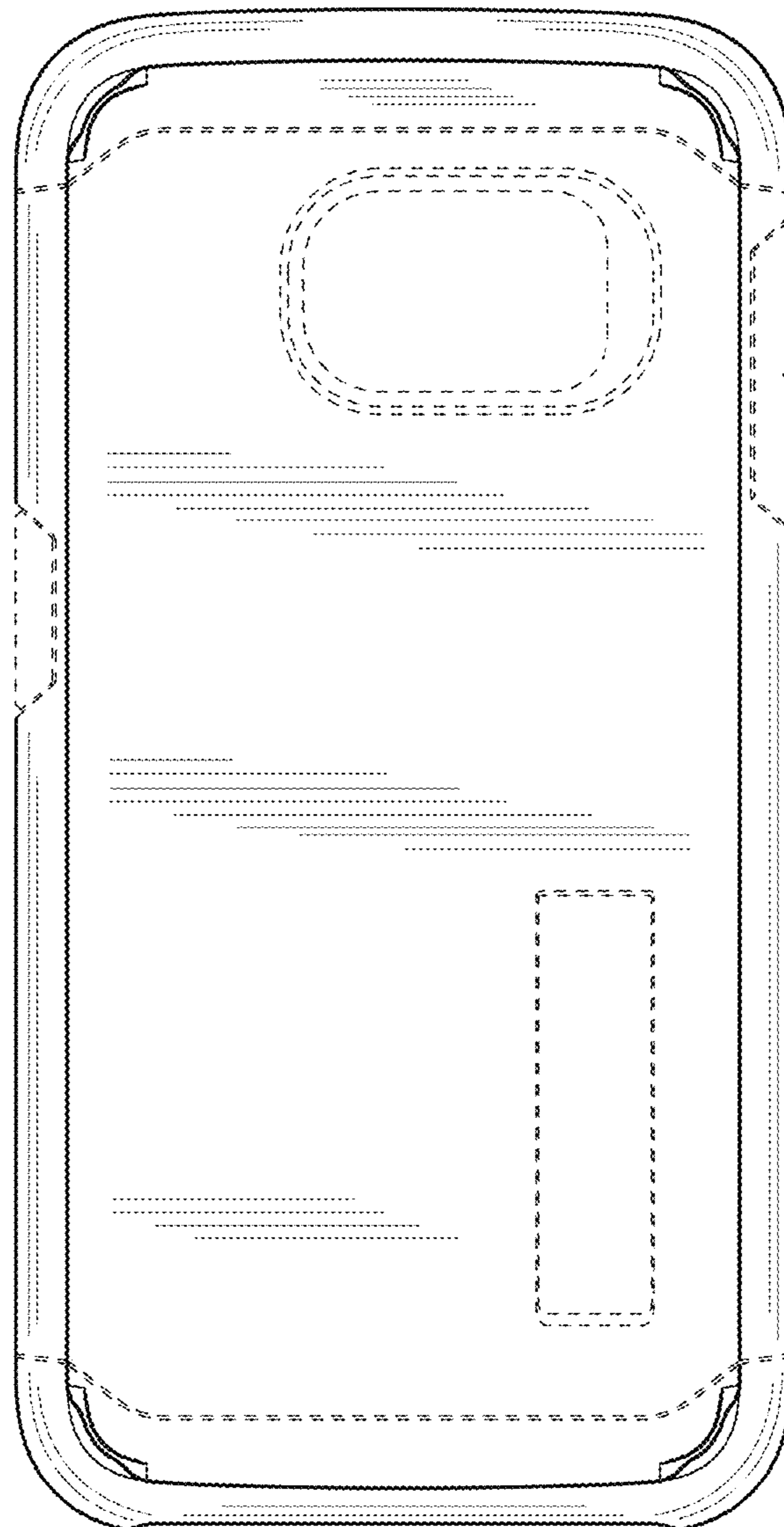

FIG. 5

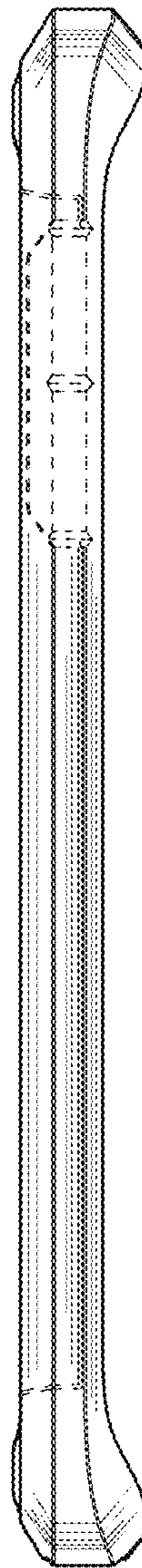

FIG. 6

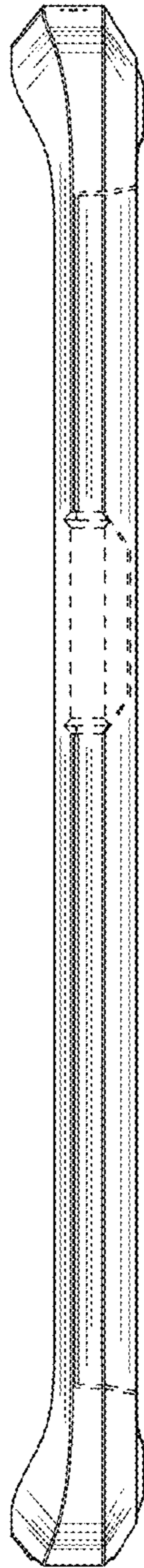



FIG. 7

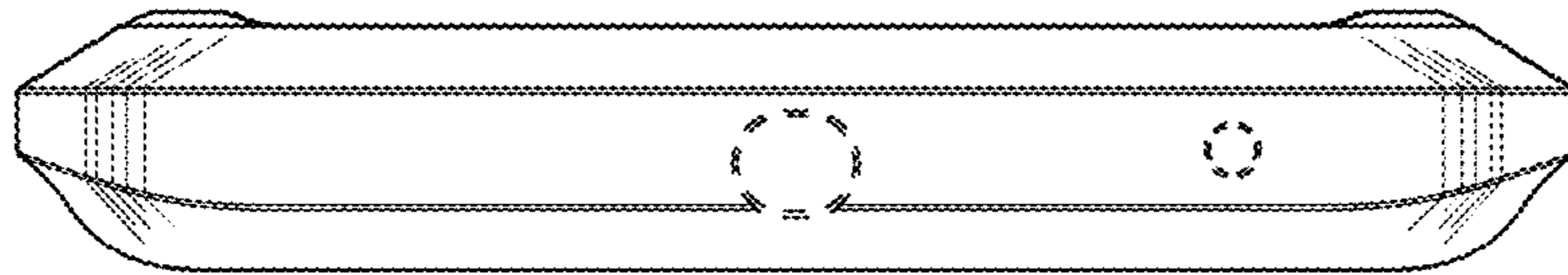

FIG. 8

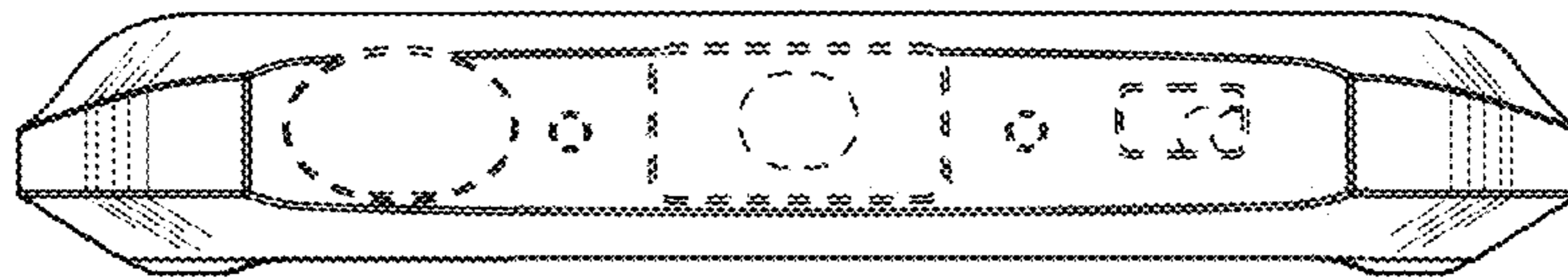

FIG. 9

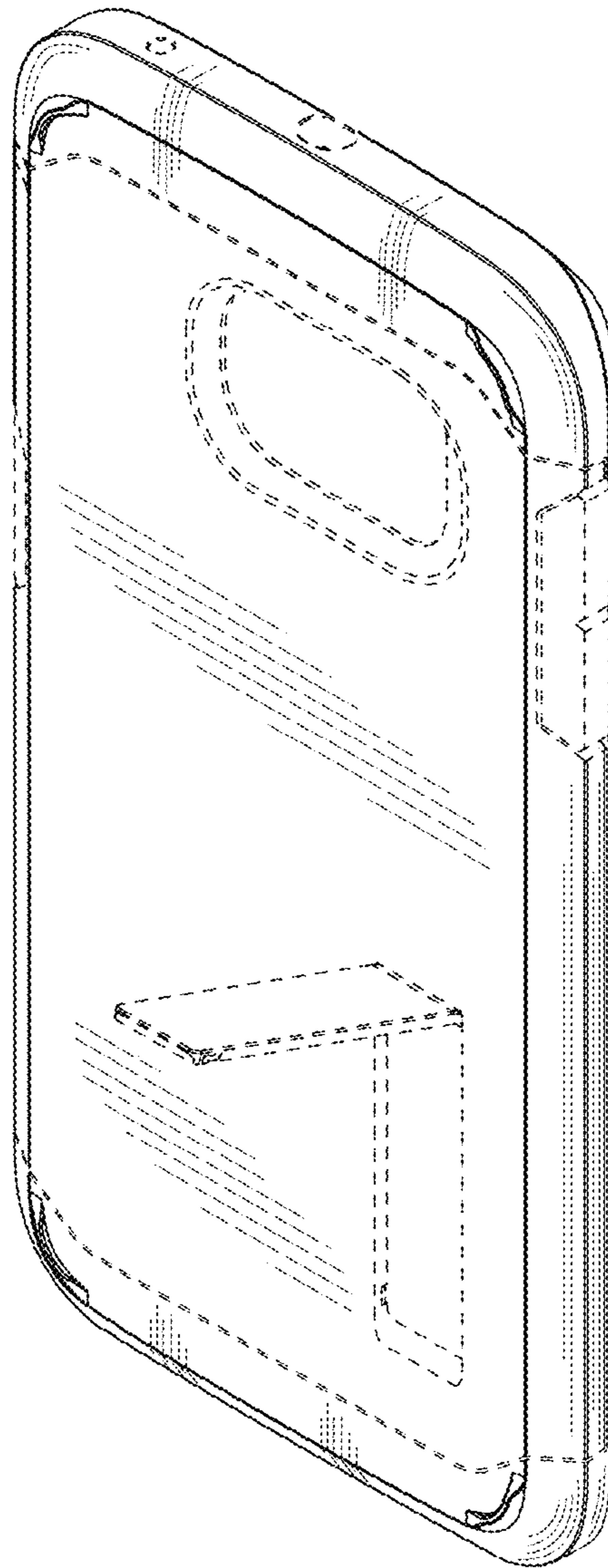

FIG. 10

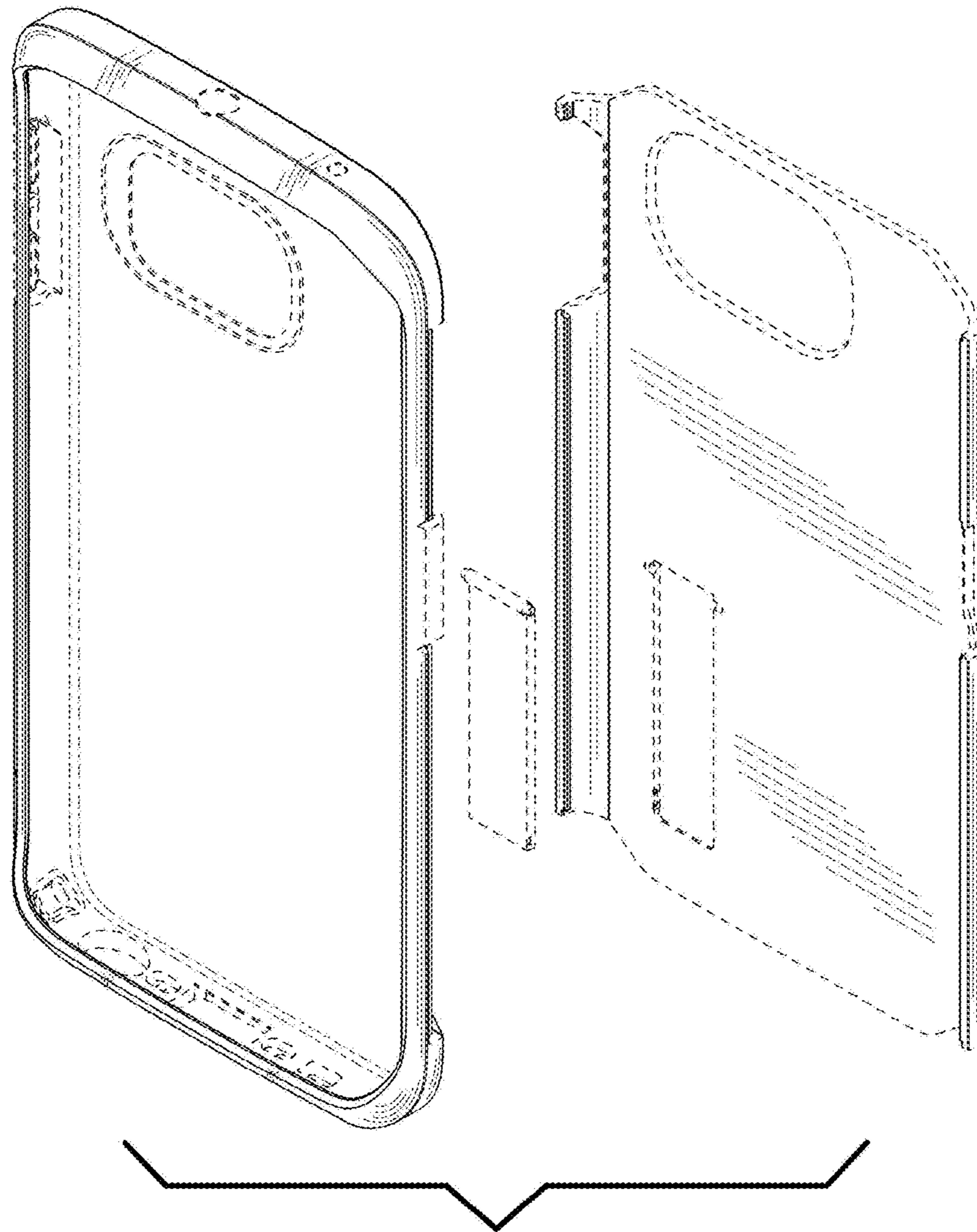



FIG. 11

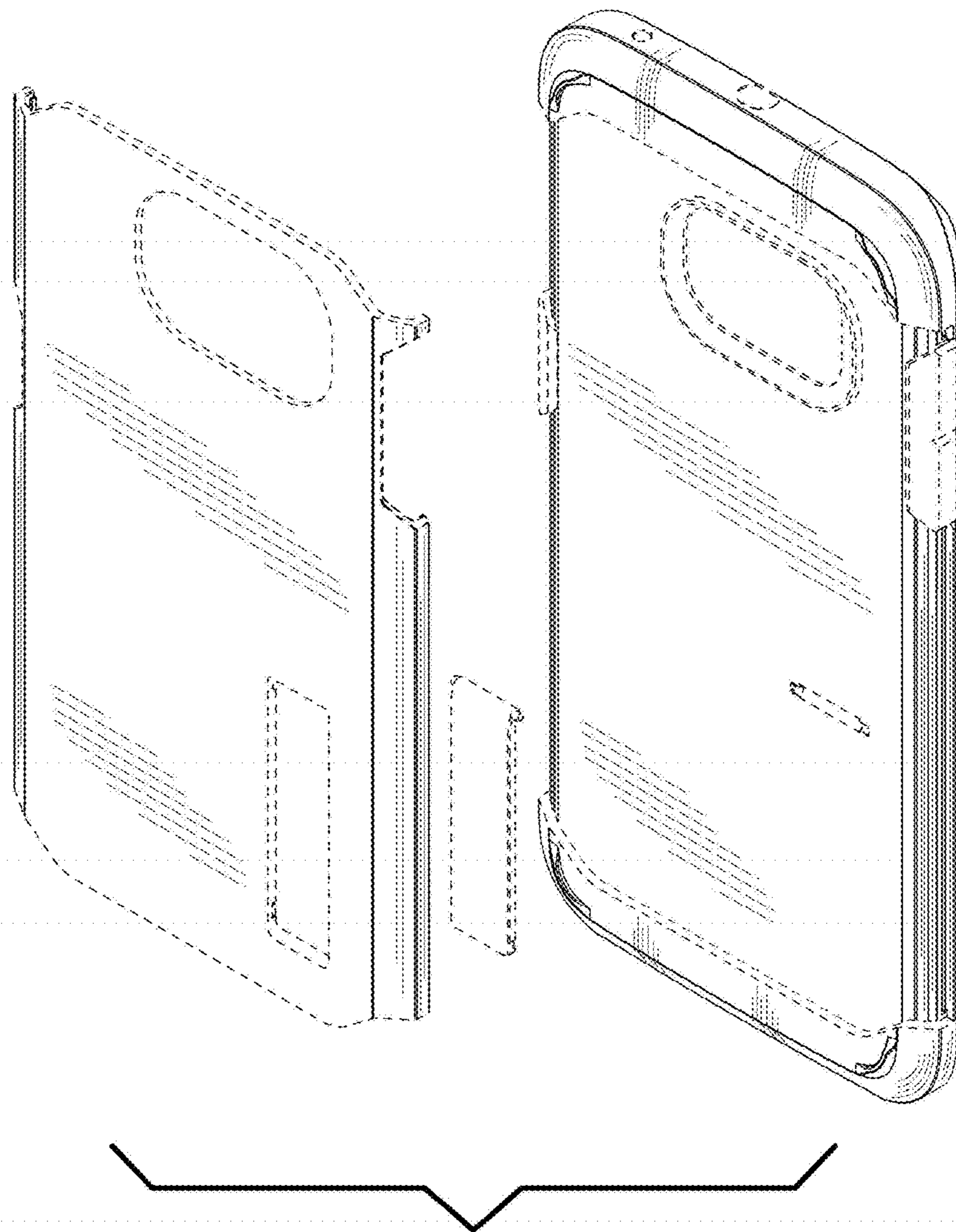

FIG. 12

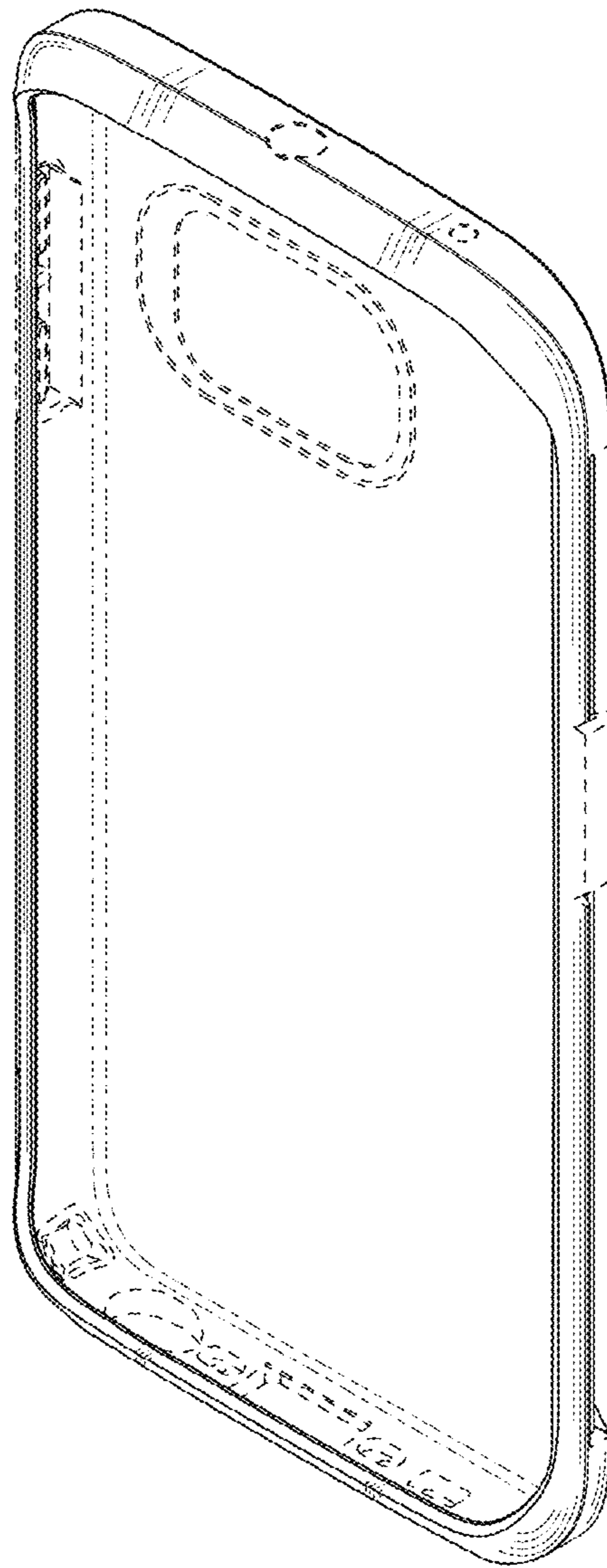

FIG. 13

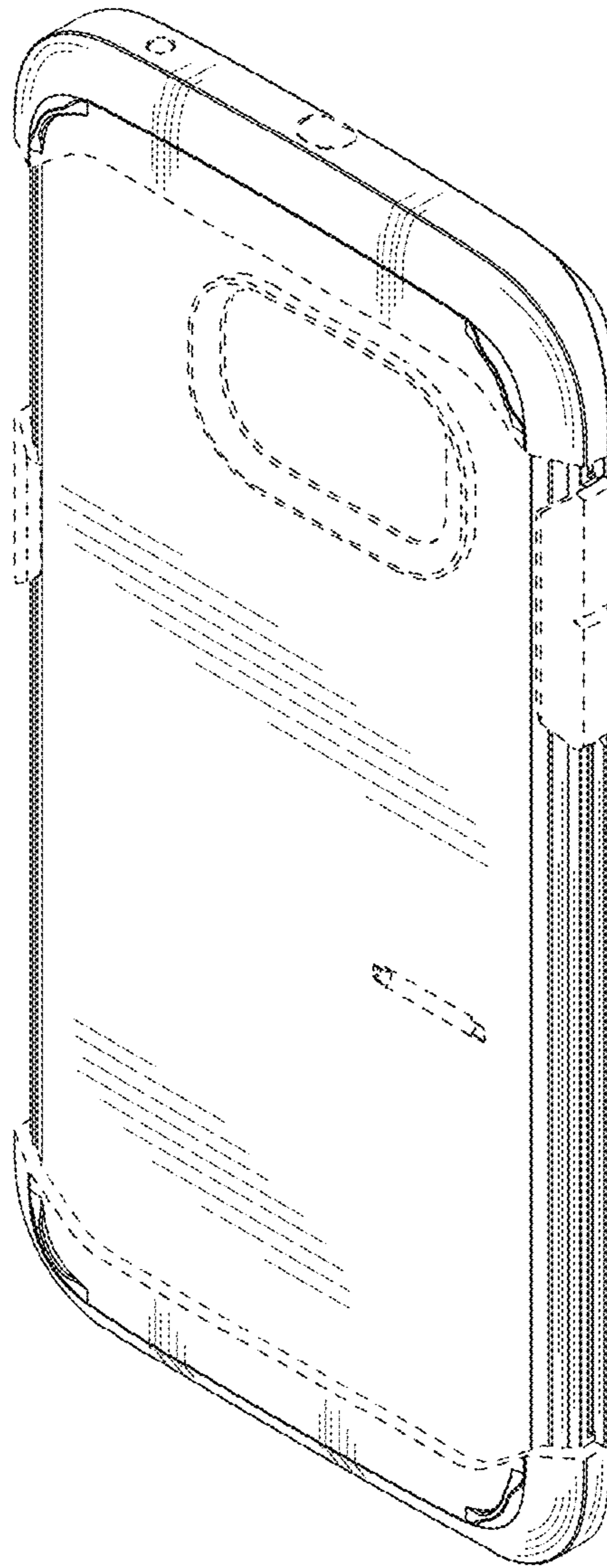

FIG. 14

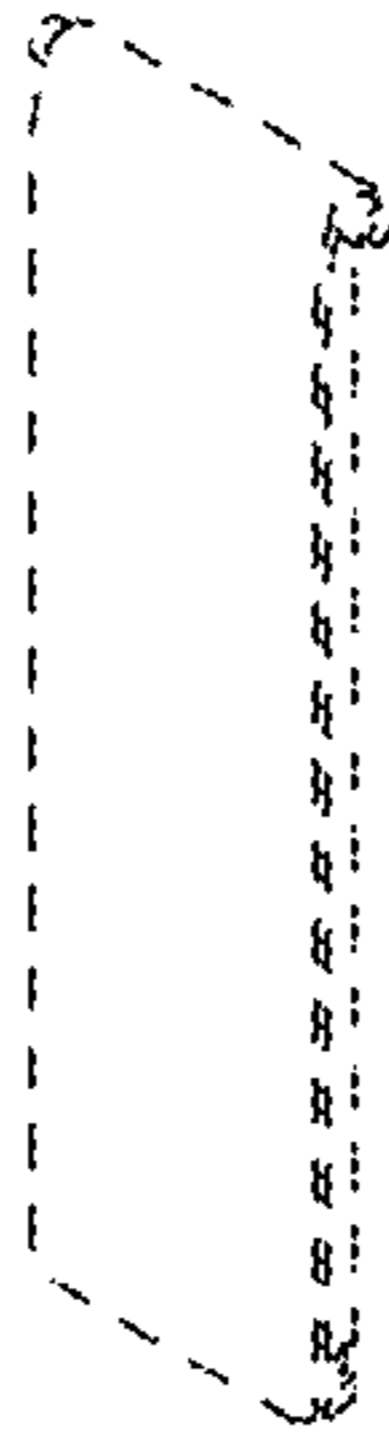



FIG. 15

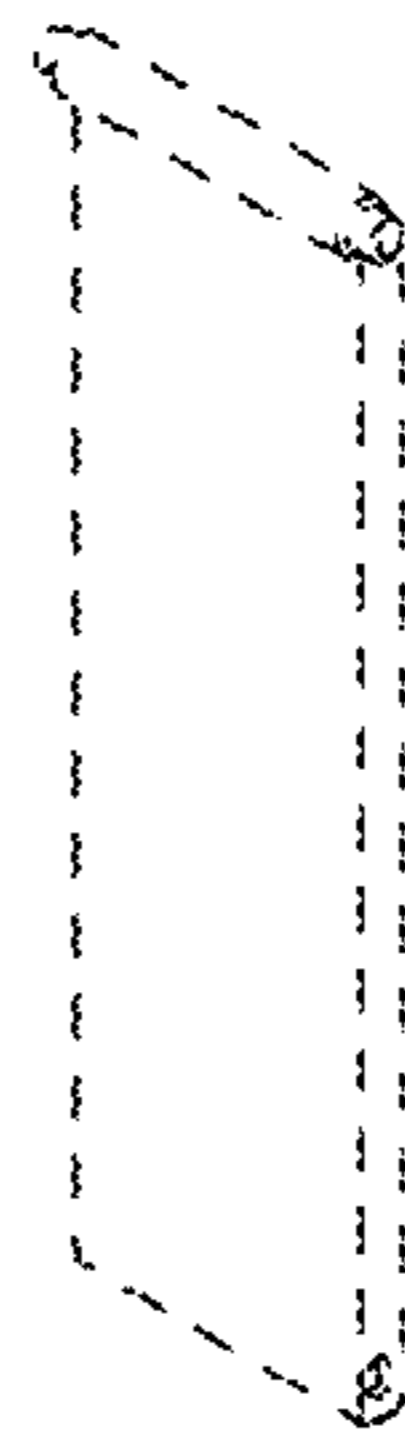

FIG. 16

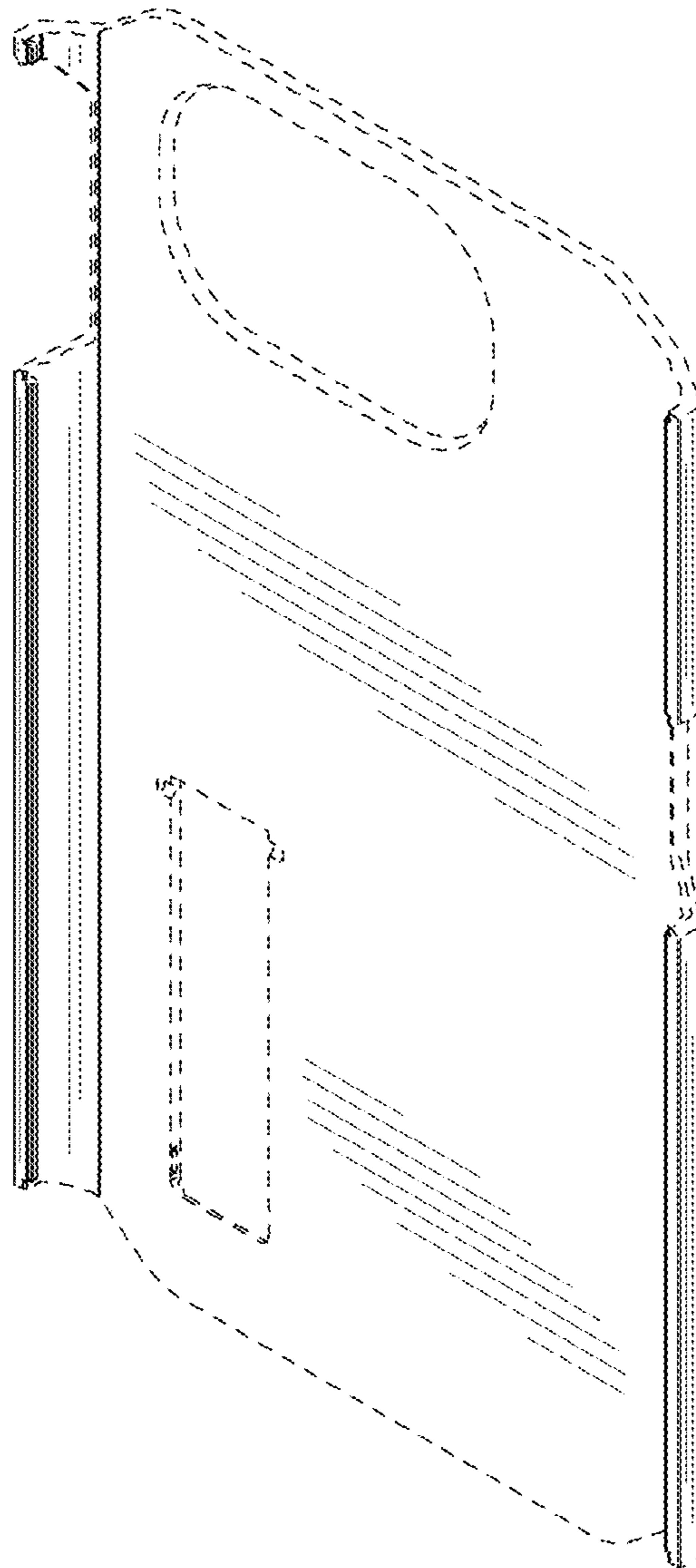

FIG. 17

