

US00D864169S

(12) **United States Design Patent**  
**Min et al.**

(10) **Patent No.:** **US D864,169 S**  
(45) **Date of Patent:** **\*\* Oct. 22, 2019**

(54) **WIRELESS EARPHONE**  
(71) Applicant: **LG ELECTRONICS INC.**, Seoul (KR)  
(72) Inventors: **Jinki Min**, Seoul (KR); **Dongsoon Kim**, Seoul (KR); **Hyunchul Kim**, Seoul (KR); **Cheolwoong Shin**, Seoul (KR)  
(73) Assignee: **LG ELECTRONICS INC.**, Seoul (KR)

(\*\*) Term: **15 Years**  
(21) Appl. No.: **35/505,679**  
(22) Filed: **Mar. 15, 2018**  
(80) **Hague Agreement Data**  
Int. Filing Date: **Mar. 15, 2018**  
Int. Reg. No.: **DM/100358**  
Int. Reg. Date: **Mar. 15, 2018**  
Int. Reg. Pub. Date: **Sep. 21, 2018**

(30) **Foreign Application Priority Data**  
Sep. 26, 2017 (KR) ..... 30-2017-0045156  
(51) **LOC (12) Cl.** ..... **14-01**  
(52) **U.S. Cl.**  
USPC ..... **D14/223**  
(58) **Field of Classification Search**  
USPC ... D14/204, 205, 206, 224, 225, 249, 138 R, D14/188, 172, 203.1, 496; D29/112; D24/106, 173, 174  
CPC ..... H04R 25/02; H04R 25/02; H04R 25/00; H04R 1/10; H04R 1/10016; H04R 1/105; H04R 1/1083; H04R 1/02; H04R 1/1041; H04R 1/28; H04R 2420/07; H04R 2430/00; H04R 2430/01; H04R 5/033  
See application file for complete search history.

(56) **References Cited**  
U.S. PATENT DOCUMENTS  
D701,195 S \* 3/2014 Katsumata ..... D14/223  
D741,299 S \* 10/2015 Brunner ..... D14/223

D761,760 S \* 7/2016 Poulsen ..... D14/205  
D764,445 S \* 8/2016 Czaniecki ..... D14/223  
D767,532 S \* 9/2016 Jen ..... D14/205  
D774,490 S \* 12/2016 Lin ..... D14/205  
D801,950 S \* 11/2017 Otani ..... D14/223  
D804,445 S \* 12/2017 Golnik ..... D14/205  
D817,920 S \* 5/2018 Paschke ..... D14/205  
D832,824 S \* 11/2018 Kim ..... D14/223  
D843,354 S \* 3/2019 Kumano ..... D14/223  
D848,981 S \* 5/2019 Kim ..... D14/223  
2018/0167713 A1 \* 6/2018 Chou ..... H04R 1/1016

**OTHER PUBLICATIONS**

Jabra Elite Active 65t True Wireless Earbud, no date available, [online], [site visited Jun. 13, 2019]. Retrieved from url:https://www.bestbuy.com/site/jabra-elite-active-65t-true-wireless-earbud-headphones-titanium-black/6252312.p?skuId=6252312 (Year: 2019).\*

\* cited by examiner

*Primary Examiner* — Jeffrey D Asch  
*Assistant Examiner* — Tracey J Bell  
(74) *Attorney, Agent, or Firm* — Birch, Stewart, Kolasch & Birch, LLP

(57) **CLAIM**

The ornamental design for a wireless earphone, as shown and described.

**DESCRIPTION**

- 1. Wireless earphone
- 1.1 : Perspective
- 1.2 : Front
- 1.3 : Back
- 1.4 : Left
- 1.5 : Right
- 1.6 : Top
- 1.7 : Bottom

**1 Claim, 7 Drawing Sheets**

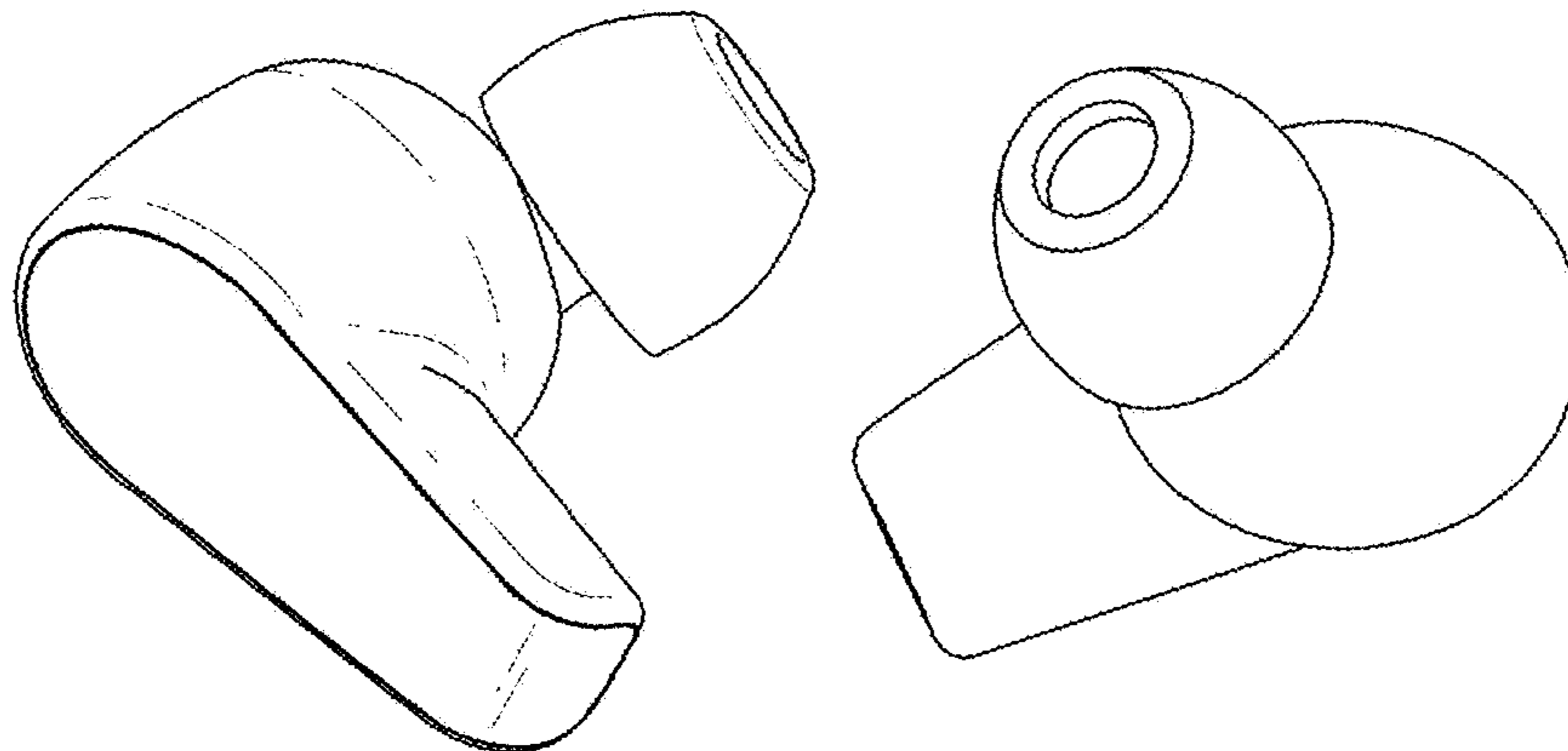

1.1

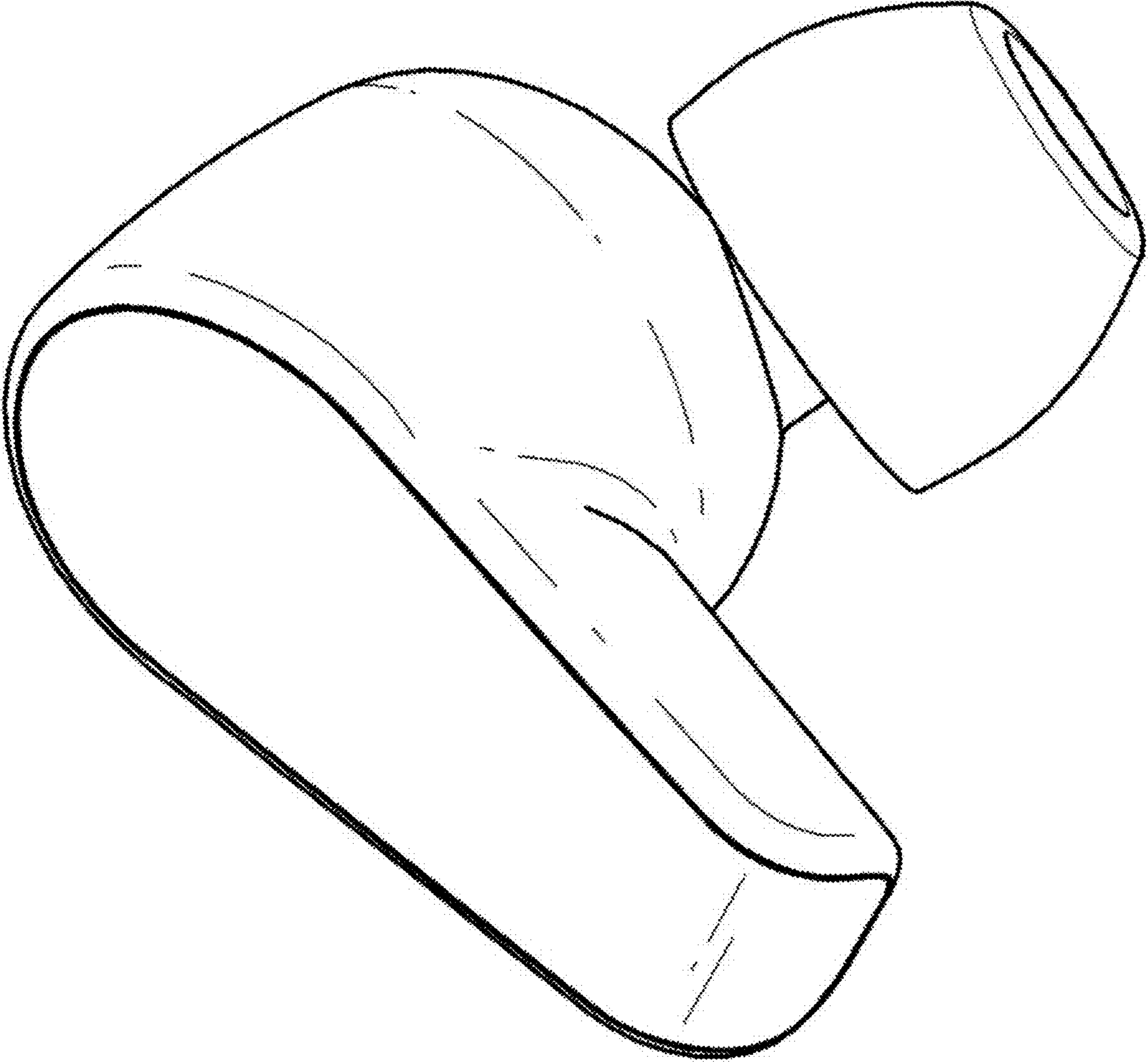

1.2

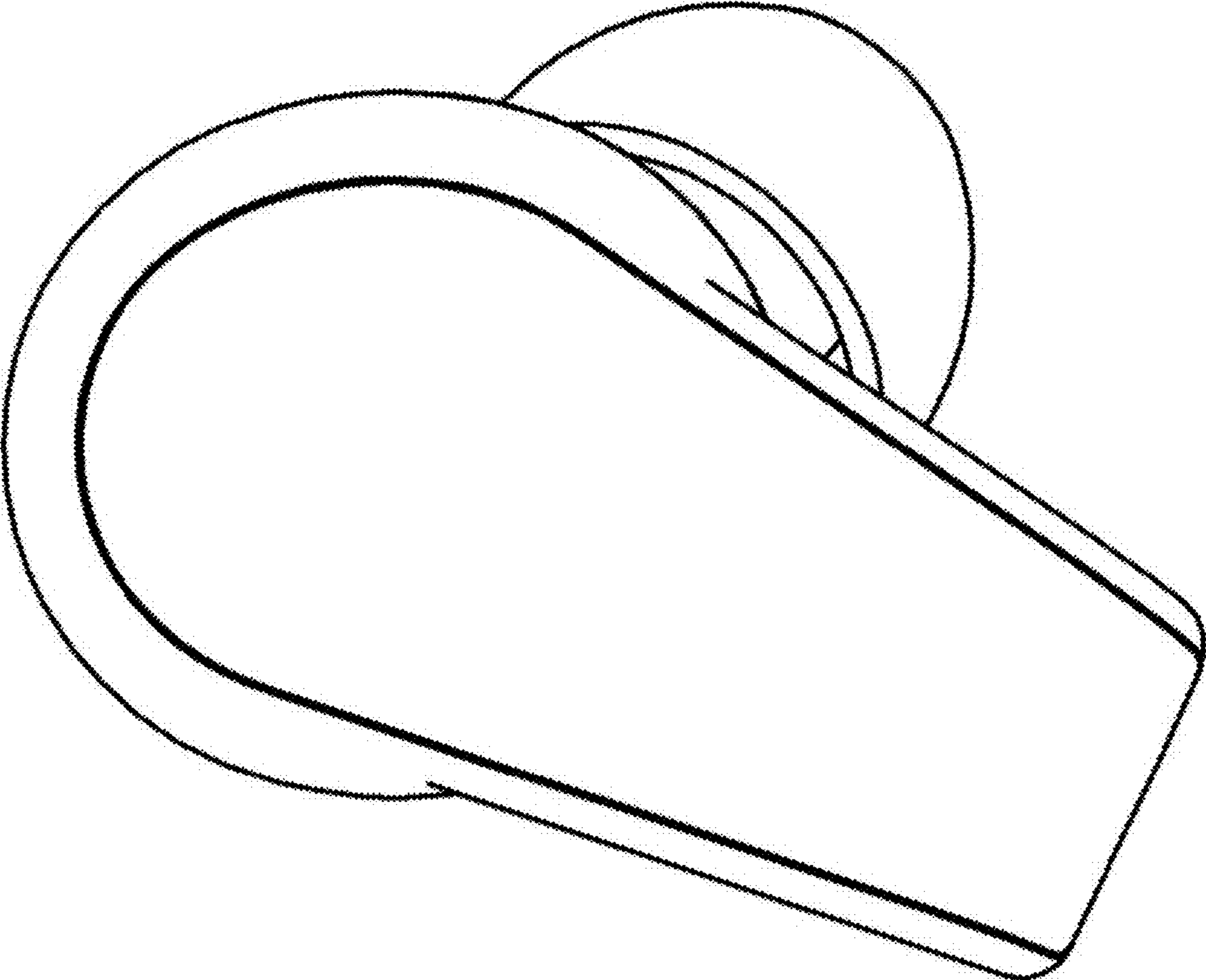

1.3

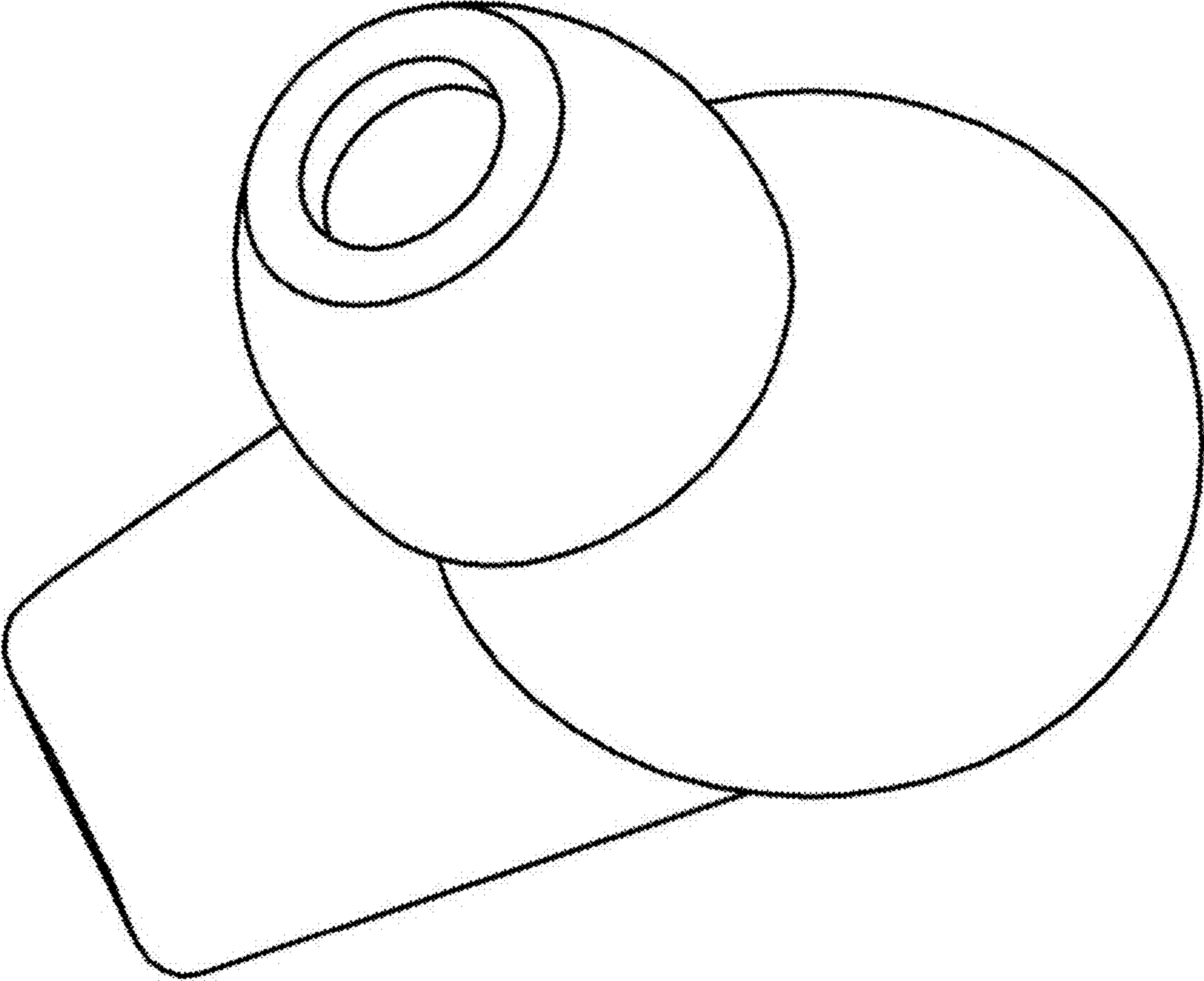

1.4

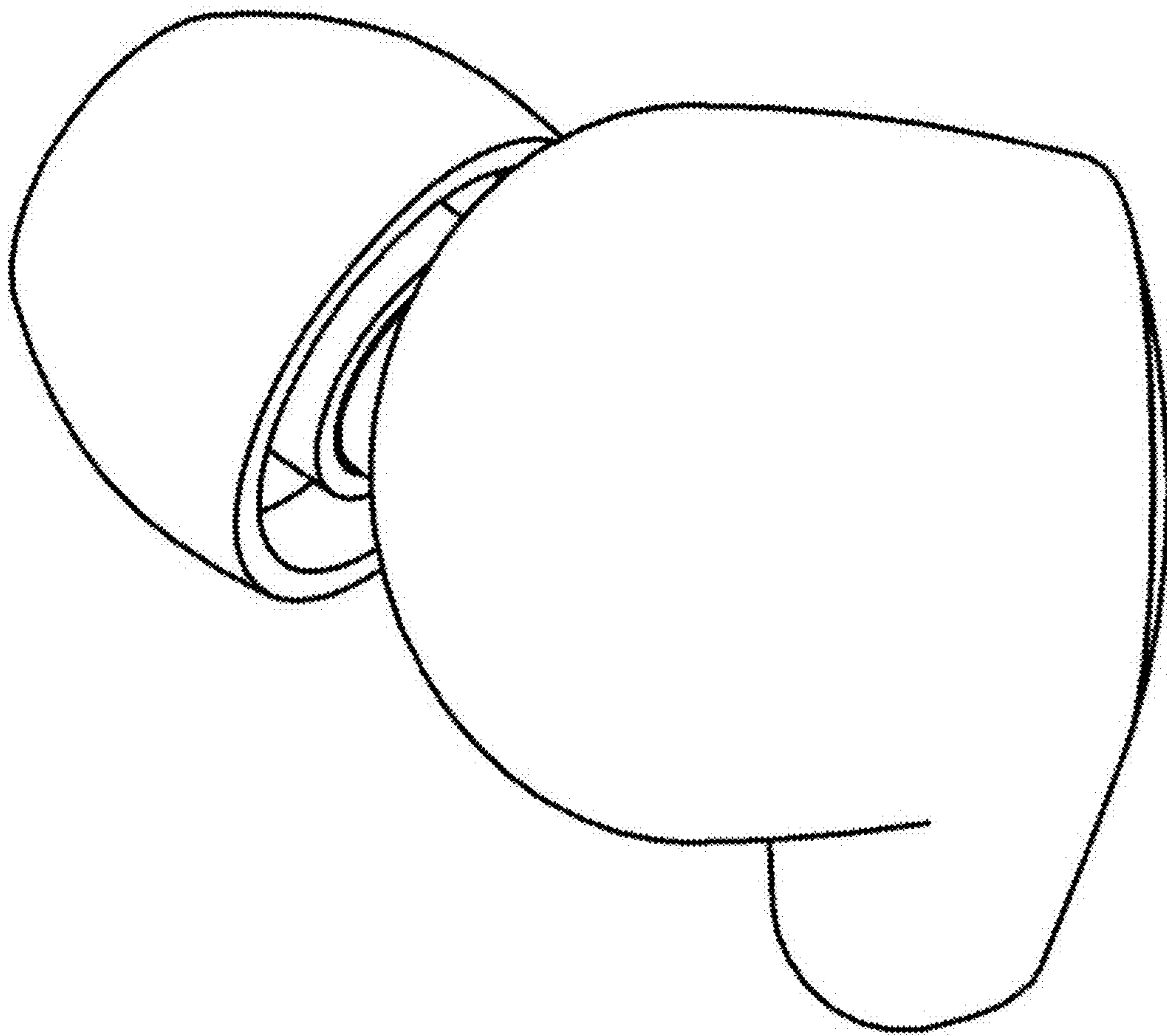

1.5

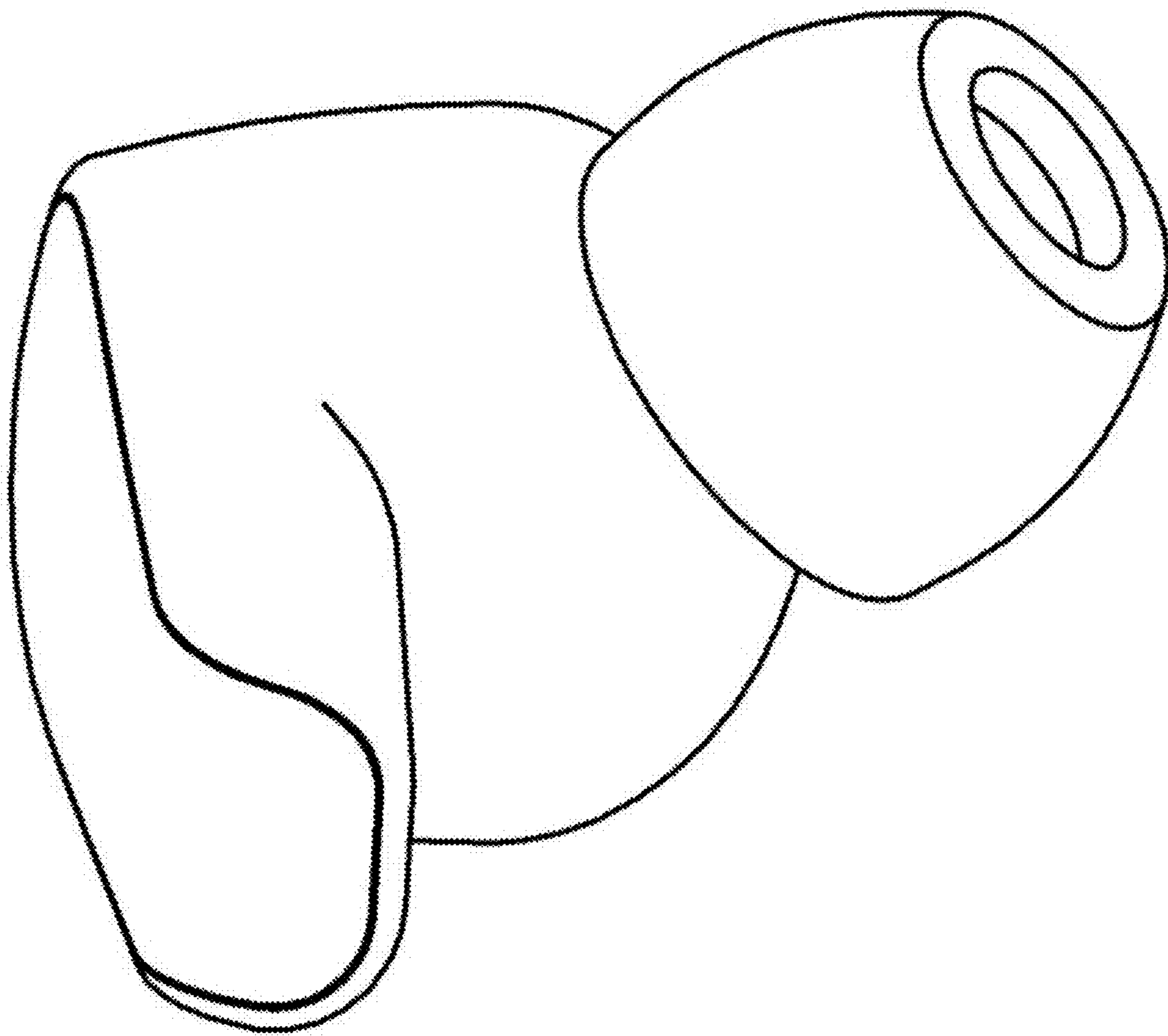

1.6

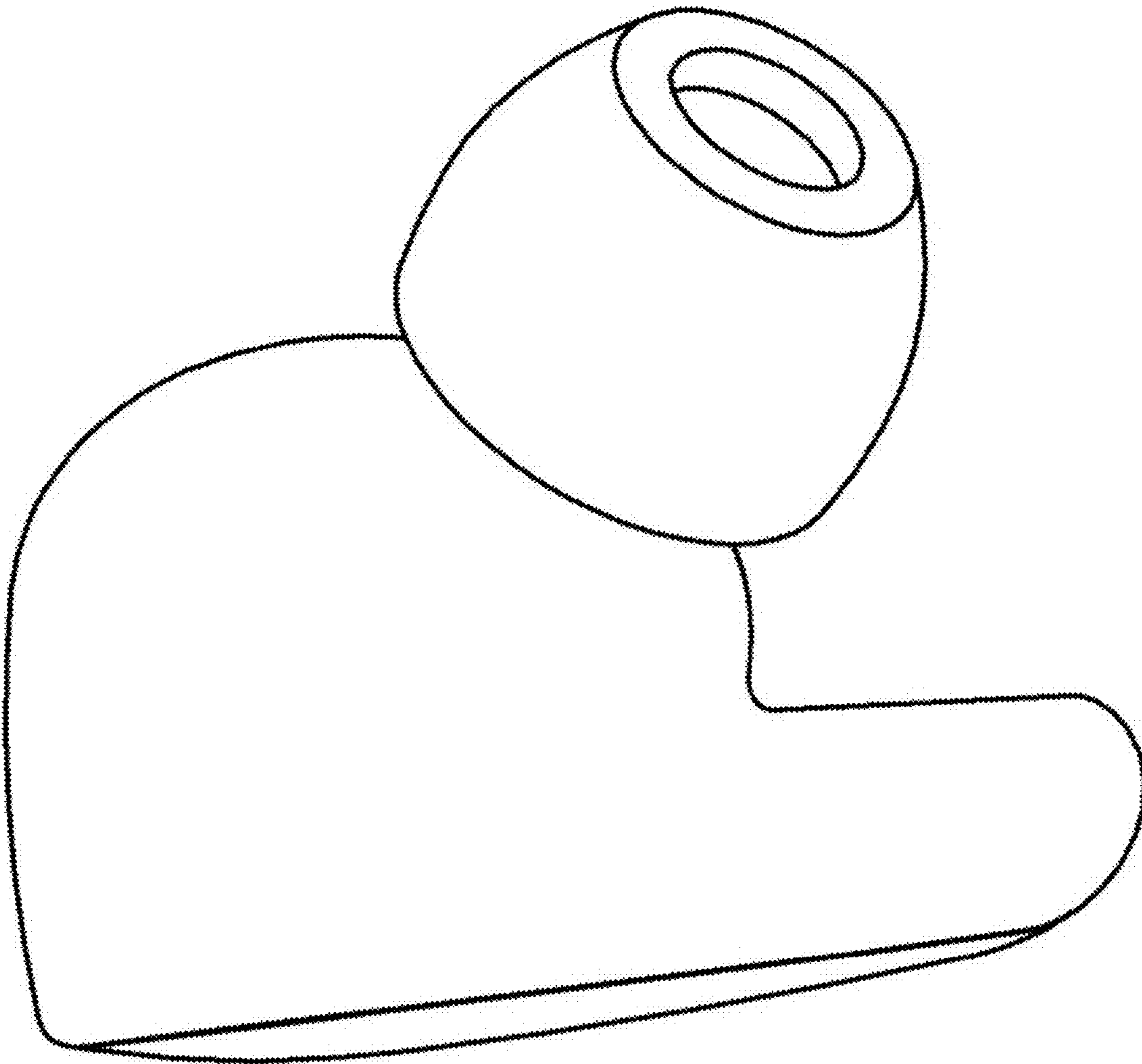

1.7

