

US00D864108S

(12) **United States Design Patent** (10) **Patent No.:** **US D864,108 S**
Ito (45) **Date of Patent:** **** Oct. 22, 2019**

(54) **HOLDER FOR VEHICLE CHARGING CABLE WITH CONNECTOR**

(71) Applicant: **HONDA MOTOR CO., LTD.**, Tokyo (JP)

(72) Inventor: **Jun Ito**, Wako (JP)

(73) Assignee: **HONDA MOTOR CO., LTD.**, Tokyo (JP)

(**) Term: **15 Years**

(21) Appl. No.: **29/639,359**

(22) Filed: **Mar. 6, 2018**

(30) **Foreign Application Priority Data**

Sep. 8, 2017 (JP) 2017-019527

(51) **LOC (12) Cl.** **13-02**

(52) **U.S. Cl.**
USPC **D13/107**

(58) **Field of Classification Search**
USPC D13/107, 108, 110, 123; D14/307
CPC B60L 11/1809-1812; B60L 11/1824; Y02T 10/7088-7094

See application file for complete search history.

(56) **References Cited**

U.S. PATENT DOCUMENTS

- D400,860 S * 11/1998 Whalley D13/154
- D626,063 S * 10/2010 Cutter D13/107
- D686,996 S * 7/2013 Seff D13/152
- D706,213 S * 6/2014 Titus D13/107
- D730,822 S * 6/2015 Chin-Ho Kim D13/107
- D731,414 S * 6/2015 Chin-Ho Kim D13/107

- D733,047 S * 6/2015 Shin D13/107
- D735,660 S * 8/2015 Ferguson D13/107
- D791,073 S * 7/2017 Kim D13/107
- D791,074 S * 7/2017 Kim D13/107
- 9,705,346 B2 * 7/2017 Bonwit H05K 5/02
- D833,387 S * 11/2018 Baxter D13/107
- D837,732 S * 1/2019 Derouineau D13/107
- D844,559 S * 4/2019 Mercer D13/107
- 2014/0125283 A1 * 5/2014 Yang H02J 7/0044 320/115

* cited by examiner

Primary Examiner — Darlington Ly

(74) *Attorney, Agent, or Firm* — Westerman, Hattori, Daniels & Adrian, LLP

(57) **CLAIM**

The ornamental design for a holder for vehicle charging cable with connector, as shown and described.

DESCRIPTION

FIG. 1 is a front perspective view of a holder for vehicle charging cable with connector showing my new design; FIG. 2 is a rear perspective view thereof; FIG. 3 is a front elevation view thereof; FIG. 4 is a rear elevation view thereof; FIG. 5 is a top plan view thereof; FIG. 6 is a bottom plan view thereof; FIG. 7 is a left side elevation view thereof; FIG. 8 is a right side elevation view thereof; and, FIG. 9 is a front perspective view thereof when in use. In FIG. 9, the broken line showing of the automobile is provided for the purpose of illustrating environmental structure and forms no part of the claimed design. All other broken lines in the drawings illustrate portions of the holder for vehicle charging cable with connector that form no part of the claimed design.

1 Claim, 9 Drawing Sheets

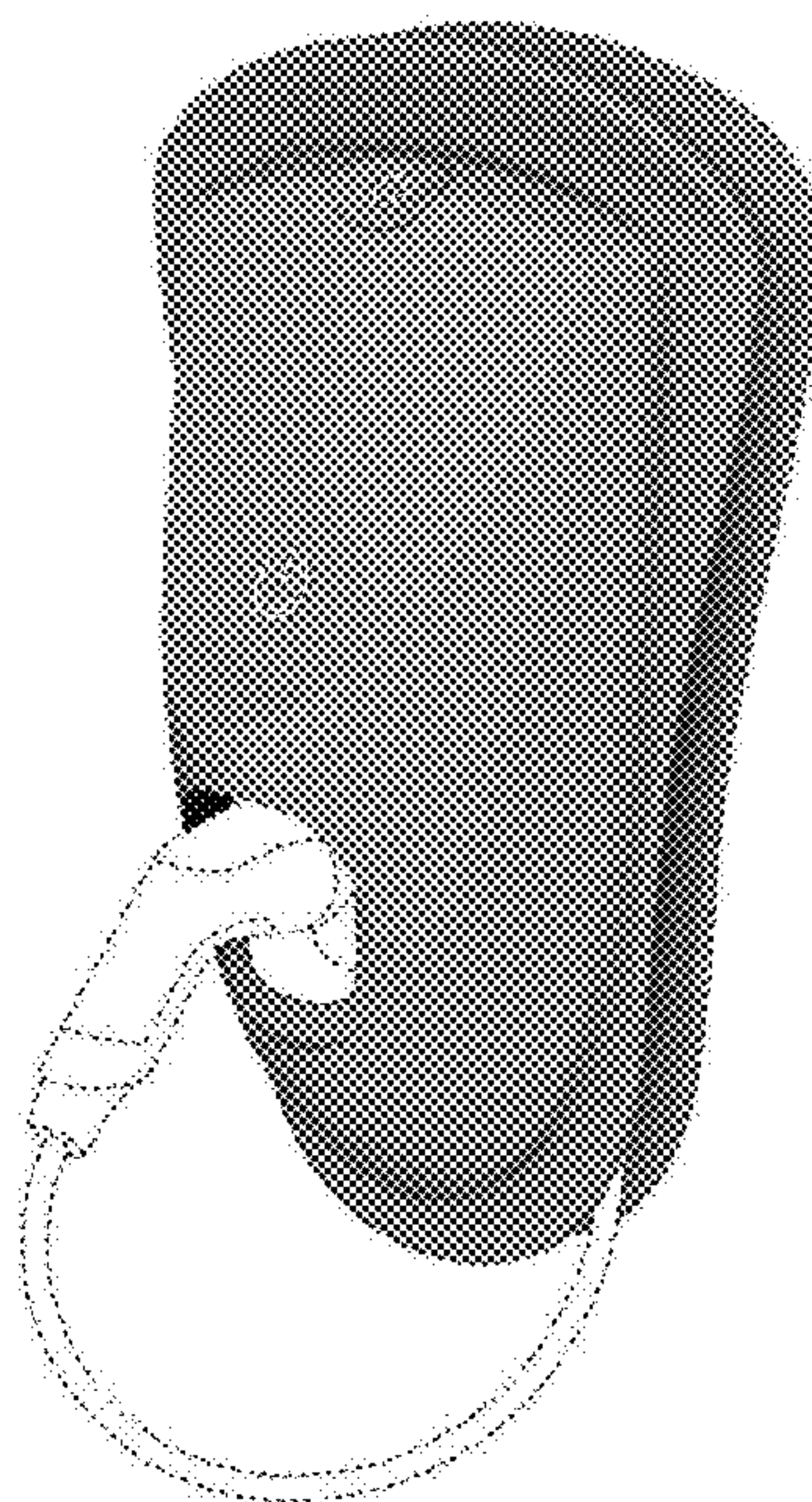

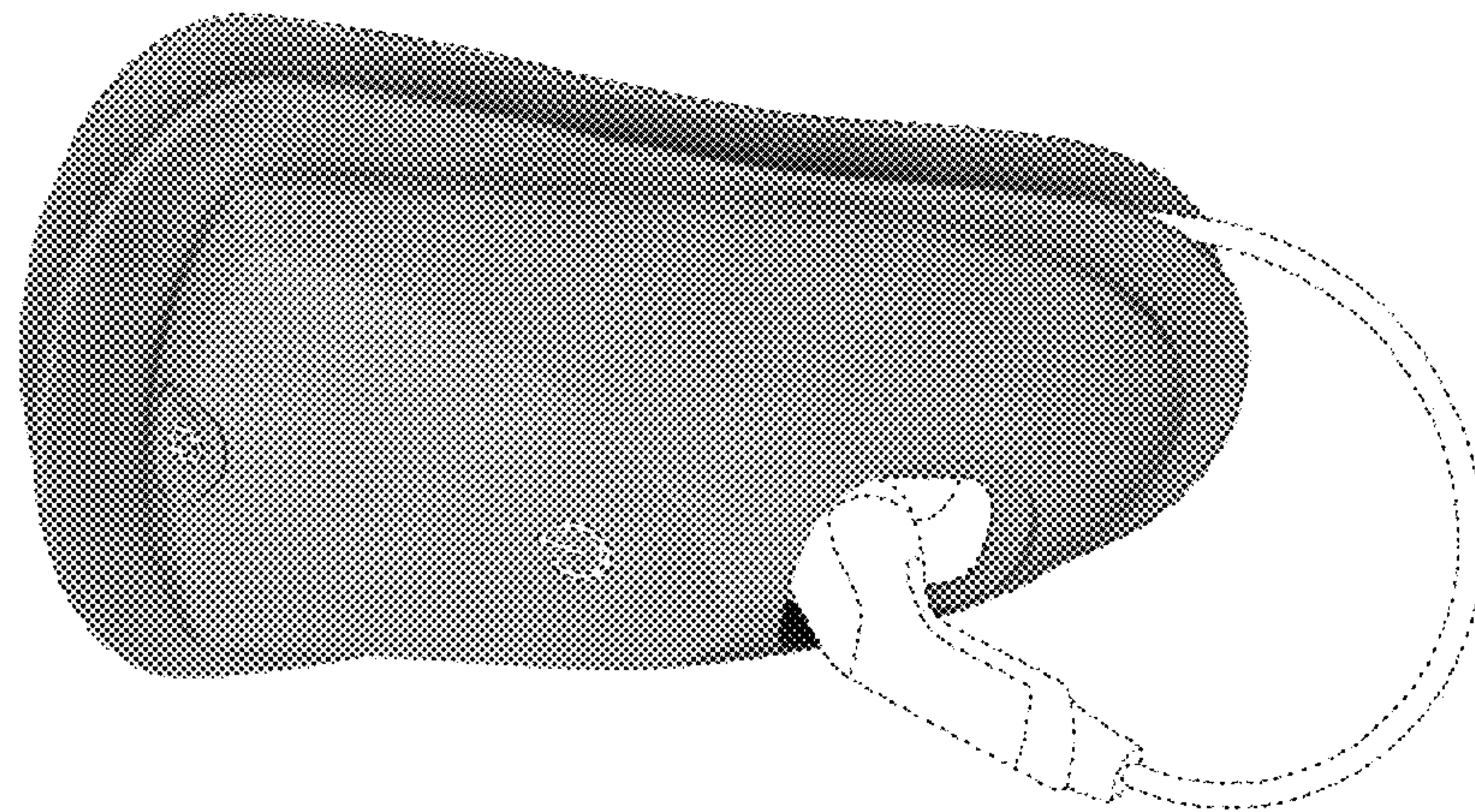

FIG. 1

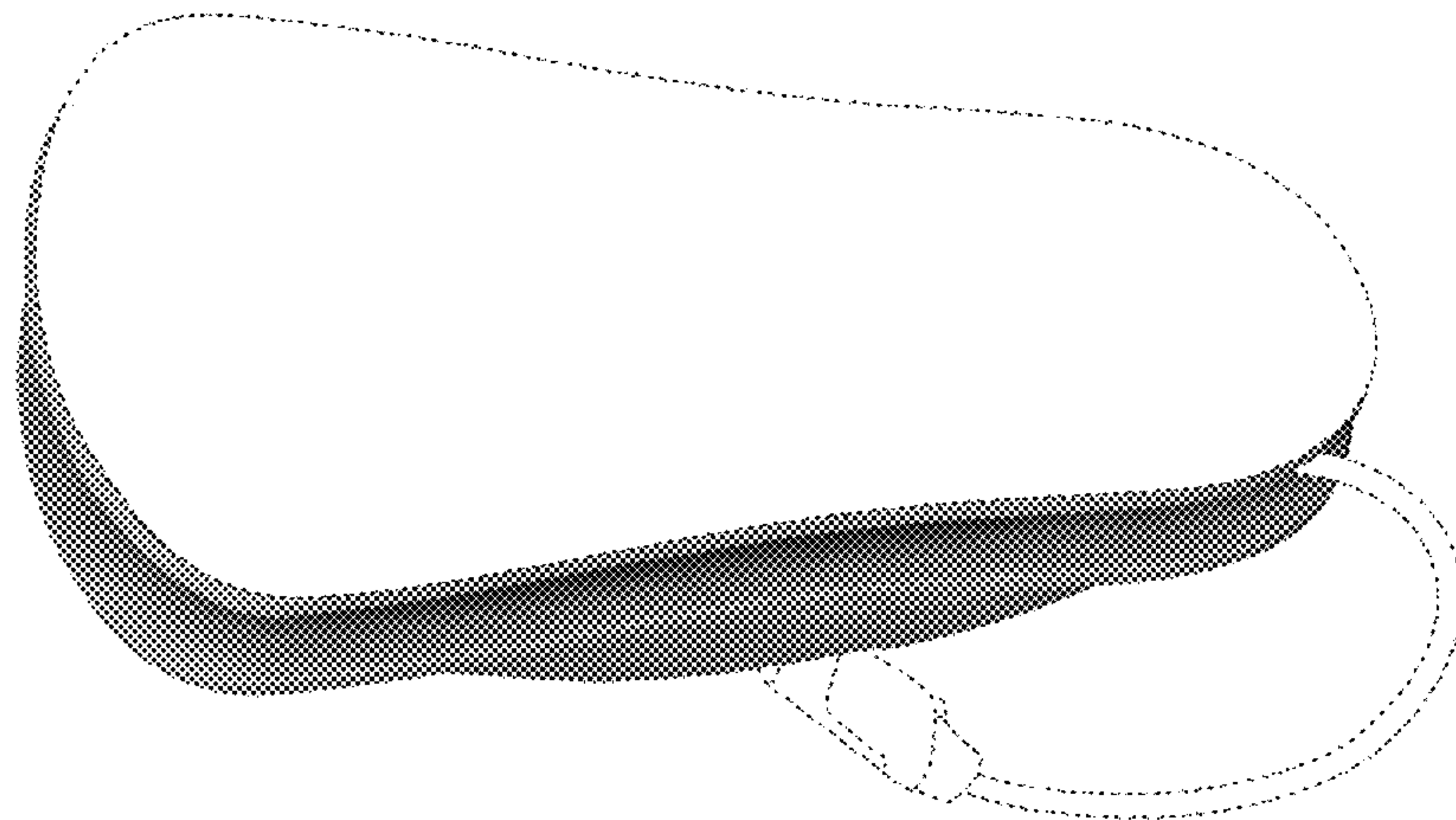

FIG.2

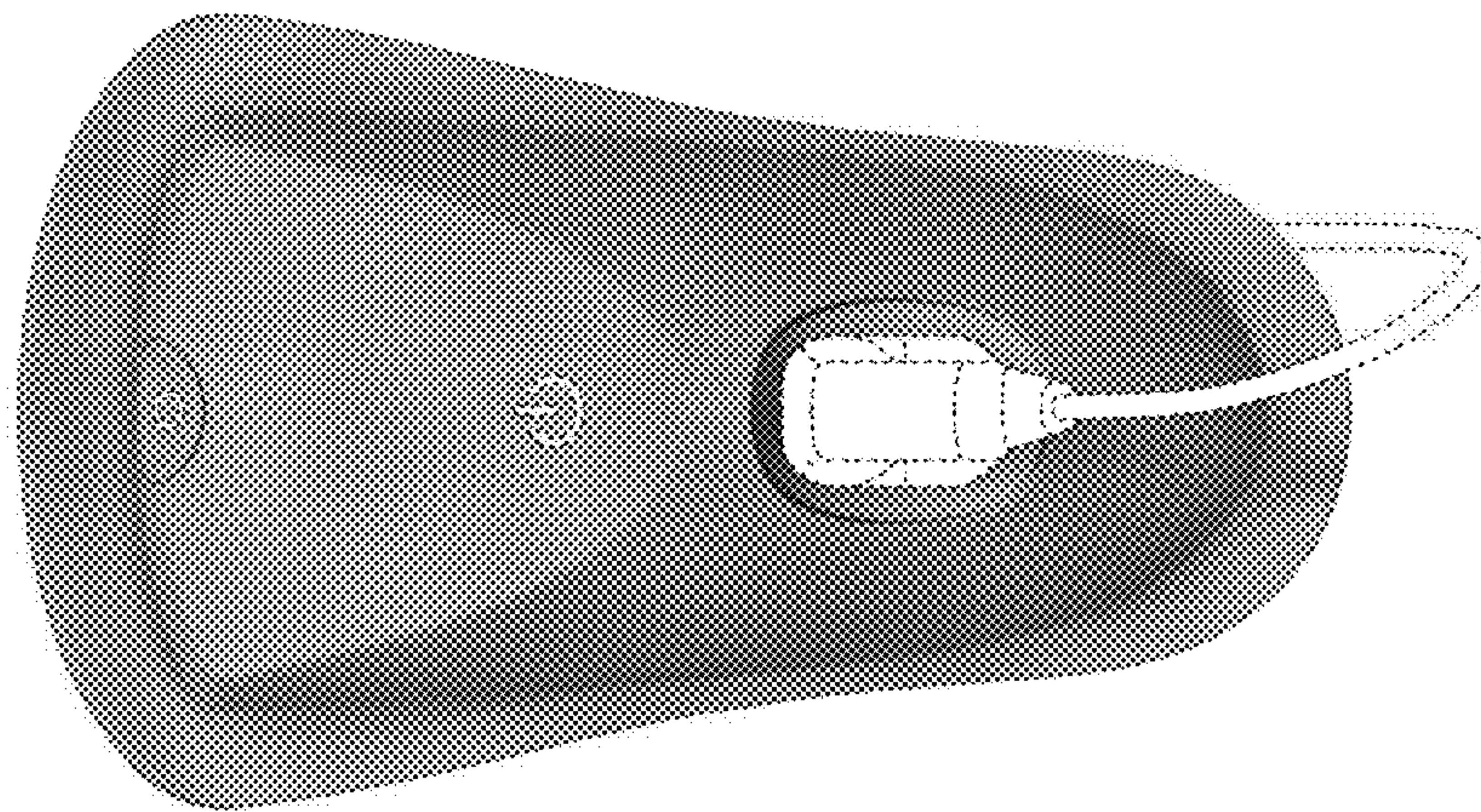

FIG.3

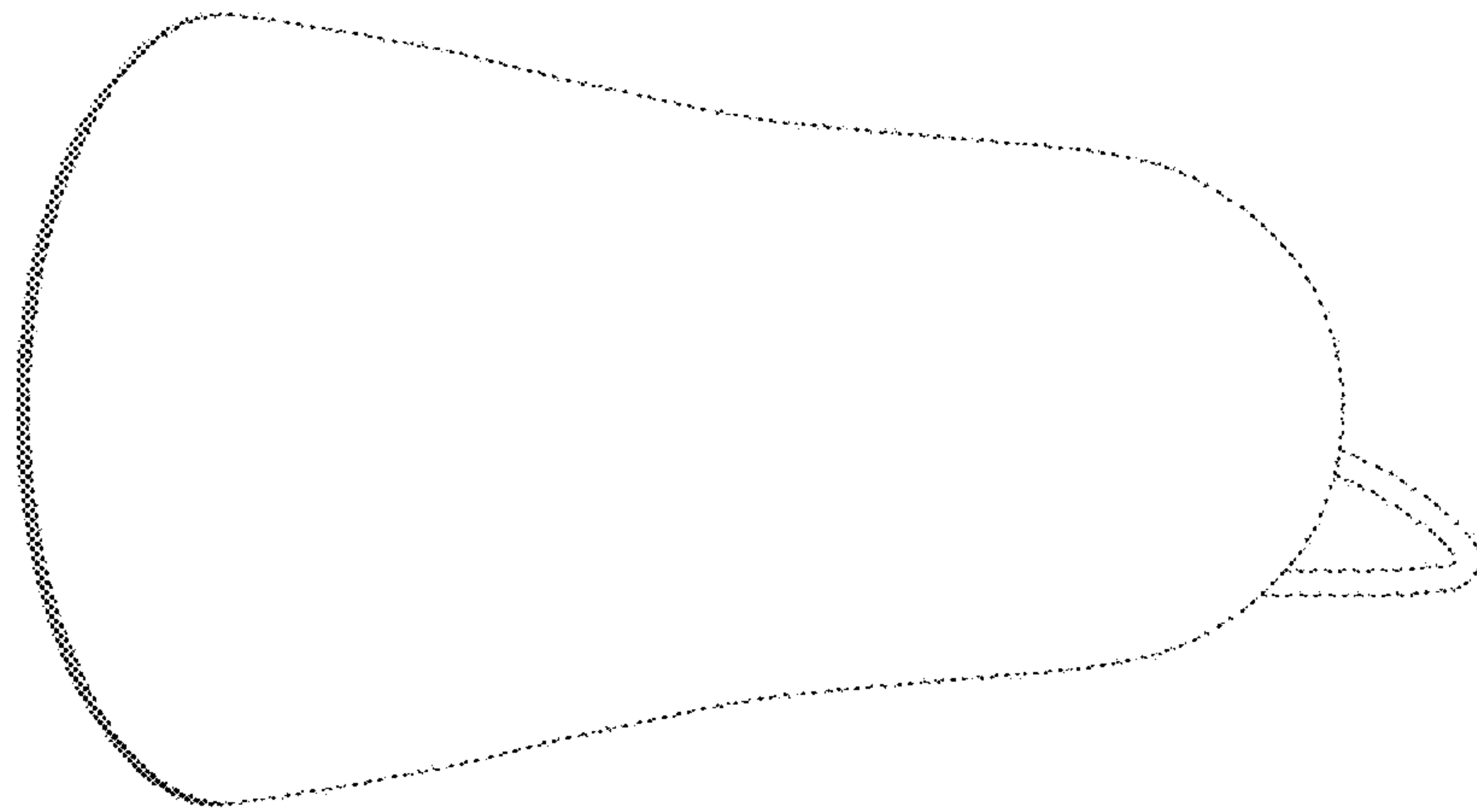

FIG.4

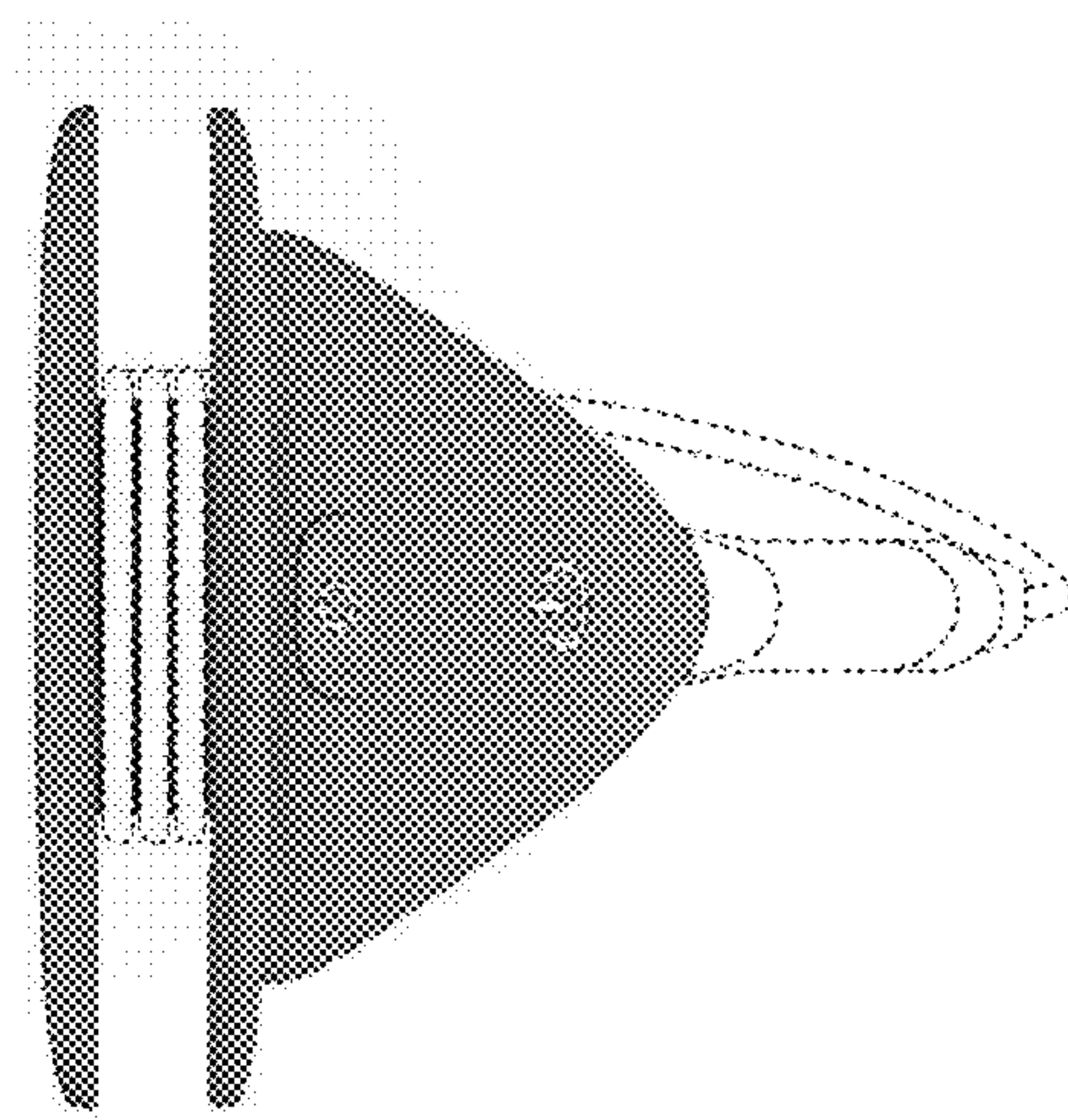

FIG. 5

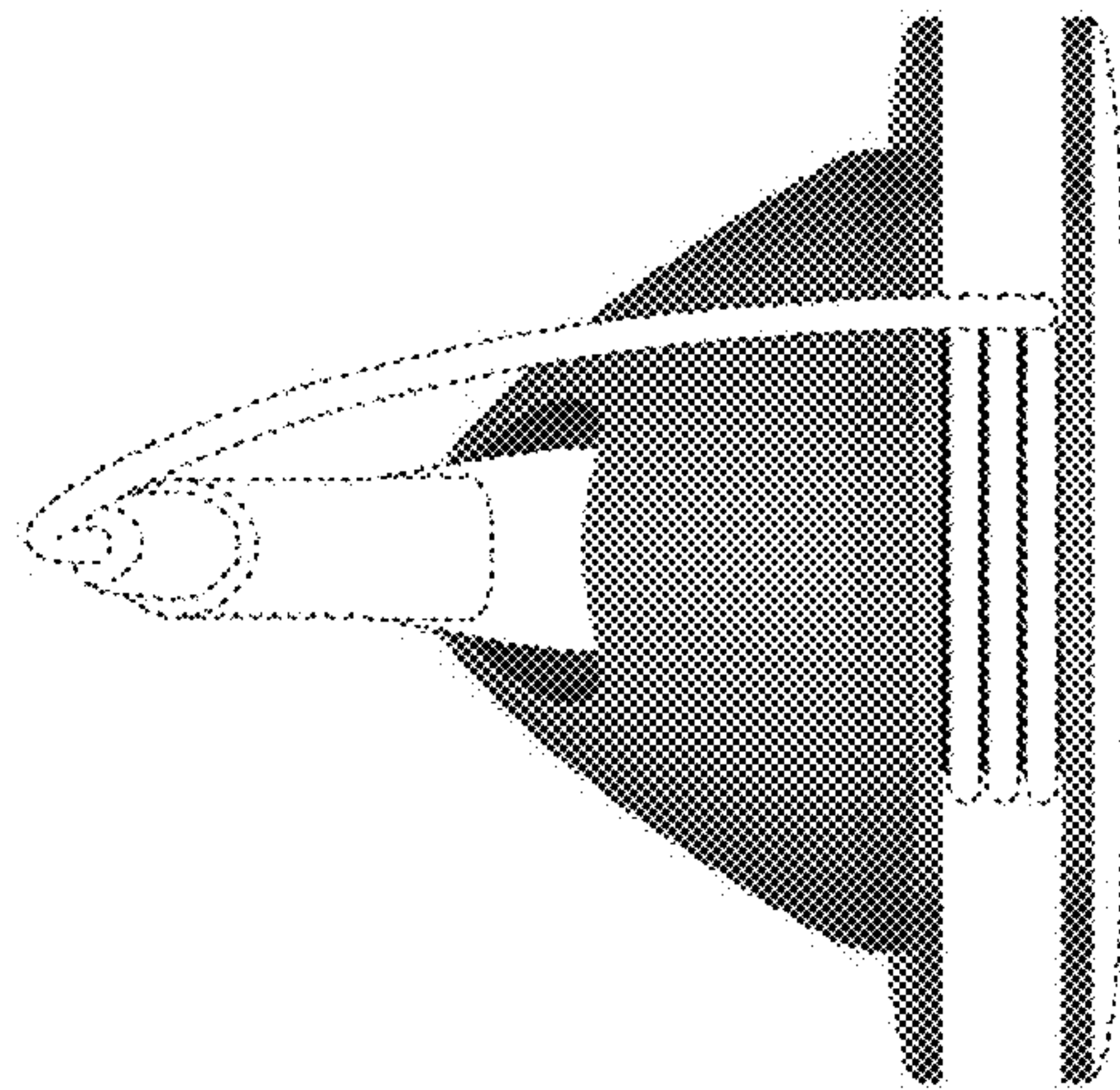

FIG.6

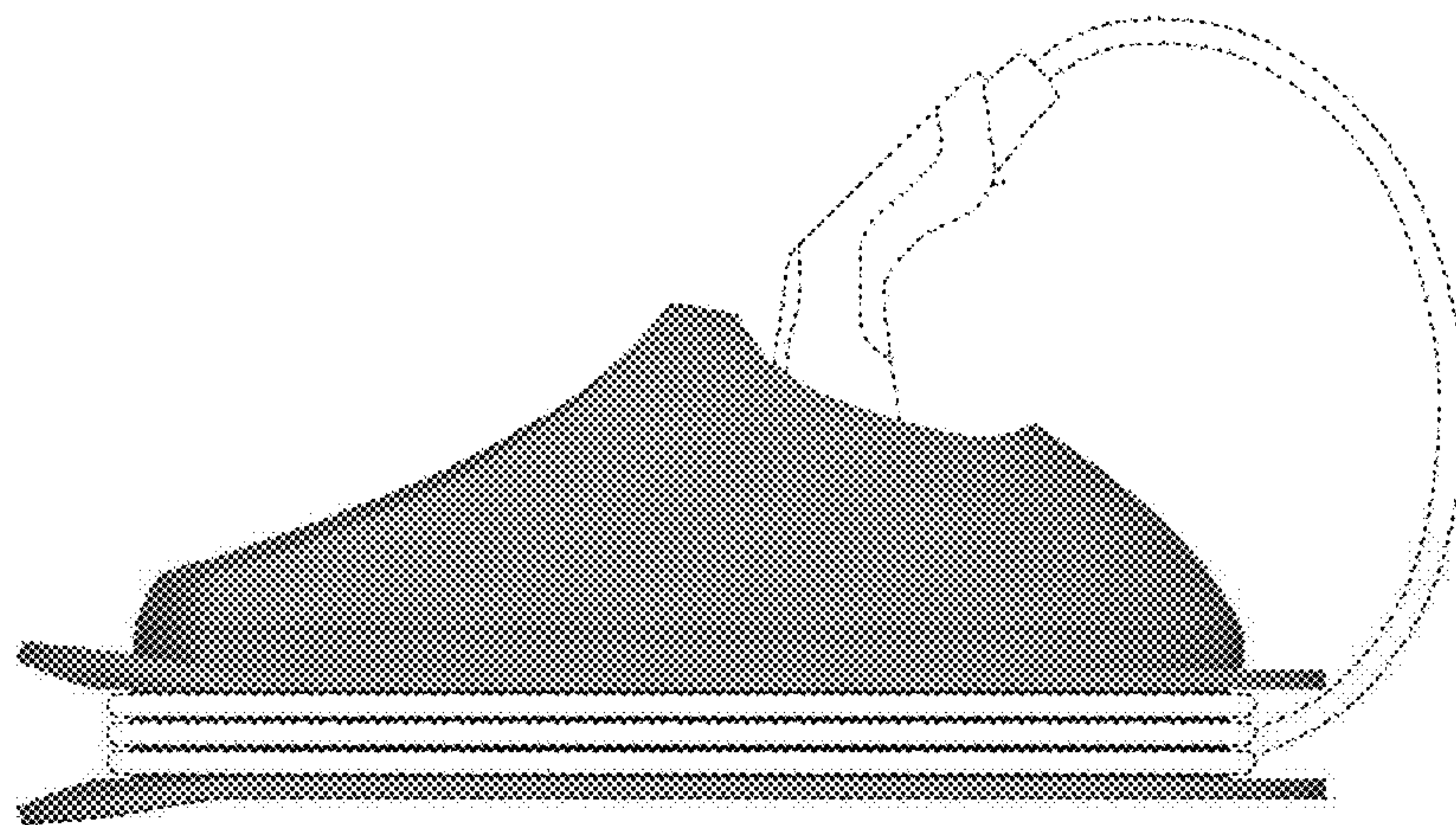

FIG.7

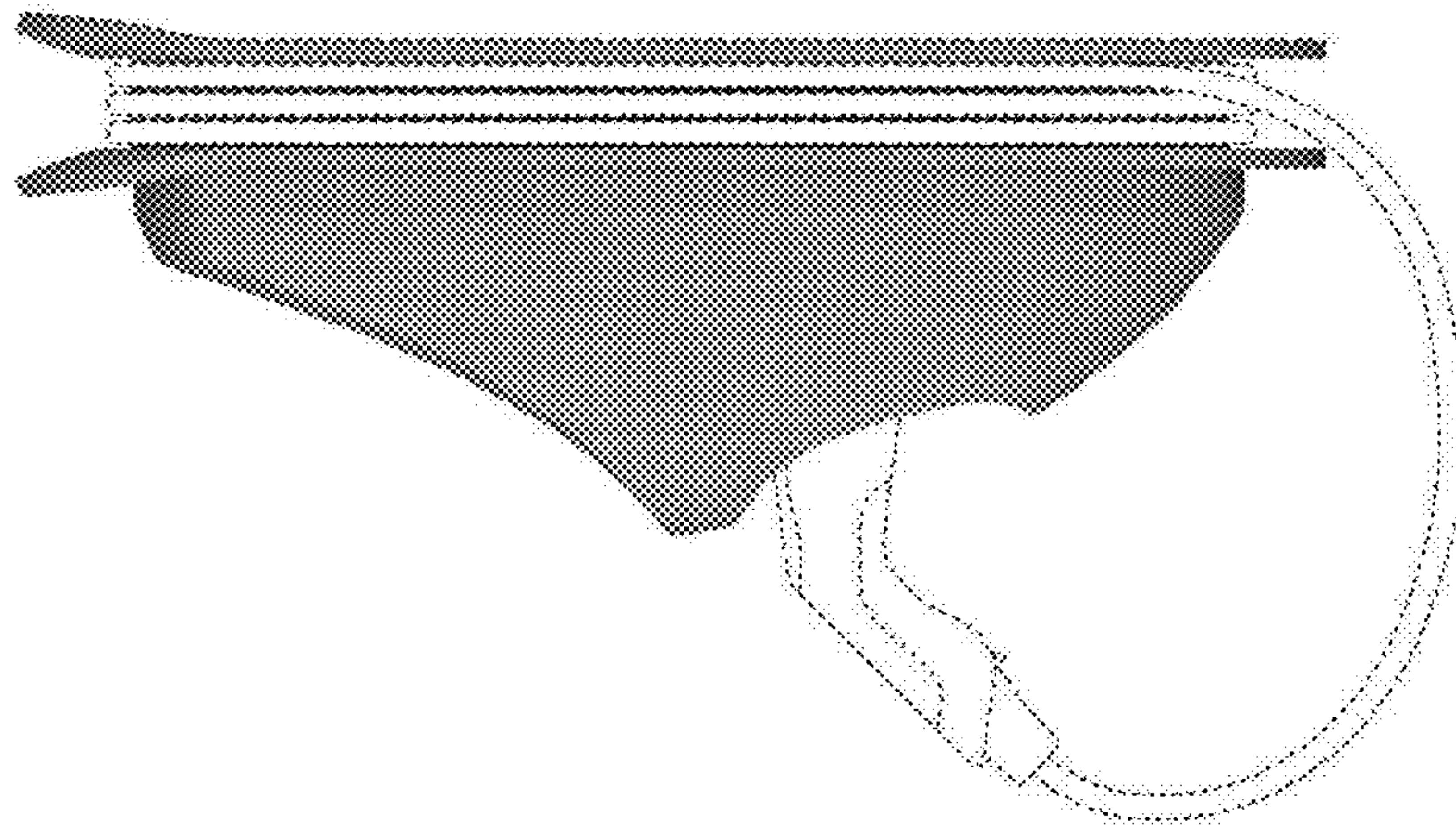

FIG. 8

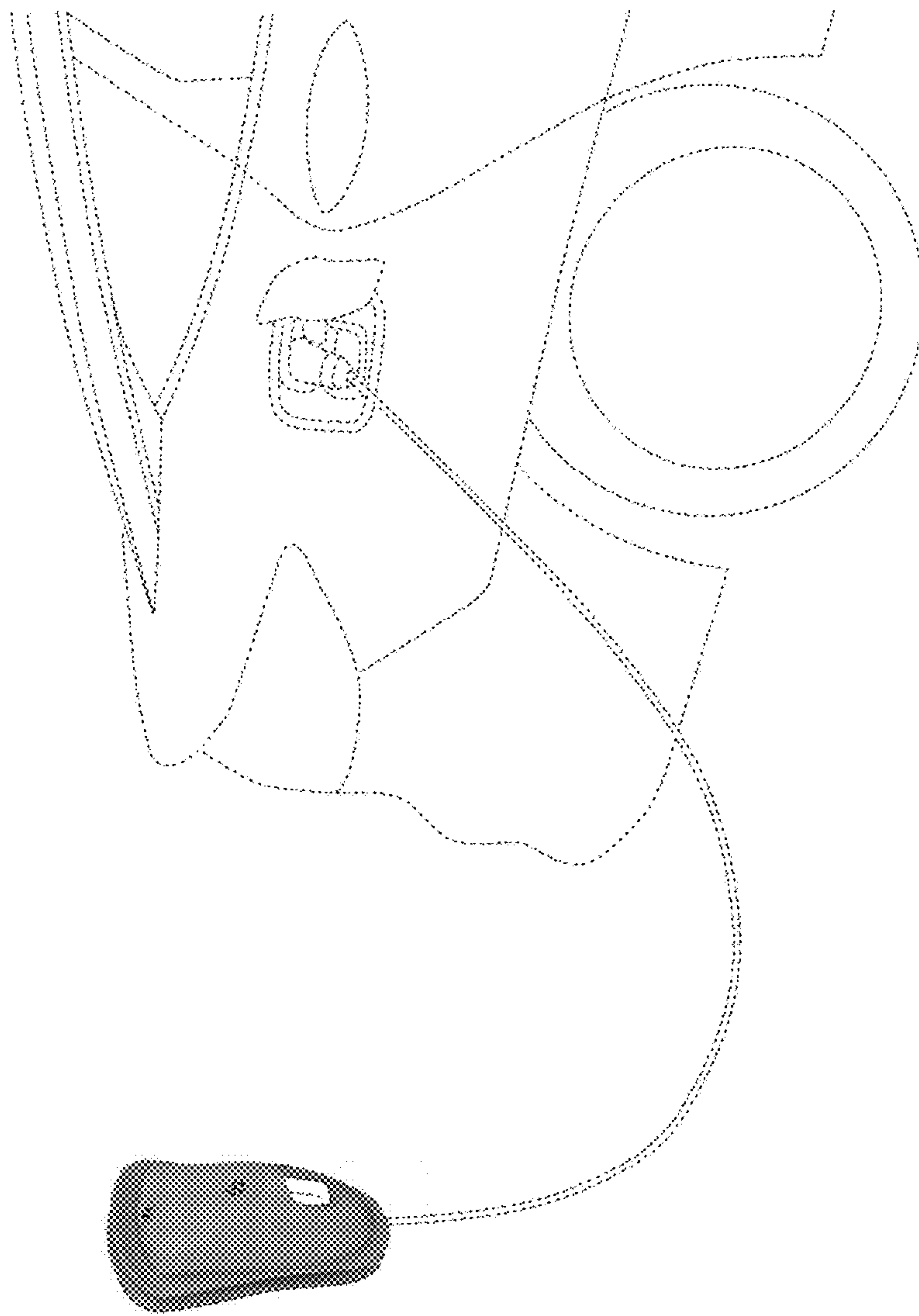

FIG. 9