



US00D863966S

(12) **United States Design Patent**
Kauffman et al.

(10) **Patent No.:** **US D863,966 S**

(45) **Date of Patent:** **** Oct. 22, 2019**

(54) **SOAP/LOTION DISPENSER**

(71) Applicant: **FC Brands Limited**, Central Hong Kong (HK)

(72) Inventors: **Heather Tomasetti Kauffman**, Larchmont, NY (US); **Pieter Schouten**, Berkeley, CA (US); **David Dennys Chitayat**, Shanghai (CN)

(73) Assignee: **FC Brands Limited**, Central Hong Kong (HK)

(**) Term: **15 Years**

(21) Appl. No.: **29/636,650**

(22) Filed: **Feb. 9, 2018**

(51) **LOC (12) Cl.** **09-01**

(52) **U.S. Cl.**
USPC **D9/504; D9/448; D9/454; D9/558; D9/688; D6/542**

(58) **Field of Classification Search**

USPC D9/434–435, 447–448, 500, 503–504, D9/516, 530, 537–539, 549, 558, 682, D9/686, 688–689, 690–691, 715, 719; D6/542

CPC B65D 1/00; B65D 1/02; B65D 1/0223; B65D 2501/00; B65D 2501/0009; A47K 5/12; A47K 5/1201; A47K 5/1211

See application file for complete search history.

(56) **References Cited**

U.S. PATENT DOCUMENTS

D347,571 S * 6/1994 Wacker D9/452
D391,485 S * 3/1998 Biesecker, II D9/500

D576,039 S * 9/2008 Bradley D9/500
D591,165 S * 4/2009 Bradley D9/691
D591,166 S * 4/2009 Bradley D9/691
D675,100 S * 1/2013 Herbst D7/511
D680,442 S * 4/2013 Park D9/682
D694,121 S * 11/2013 Park D9/682
D713,167 S * 9/2014 Snell D6/542
D724,385 S * 3/2015 Hurley D7/511
D839,050 S * 1/2019 Sibbert D7/510

OTHER PUBLICATIONS

Co-pending U.S. Appl. No. 29/636,651, filed Feb. 9, 2018.

* cited by examiner

Primary Examiner — Dana Meyrow

(74) *Attorney, Agent, or Firm* — Pierce Atwood LLP

(57) **CLAIM**

The ornamental design for a soap/lotion dispenser, as shown and described.

DESCRIPTION

FIG. 1 is a front perspective view of a soap/lotion dispenser showing the design;

FIG. 2 is a left elevation view thereof;

FIG. 3 is a right elevation view thereof;

FIG. 4 is a rear elevation view thereof;

FIG. 5 is a front elevation view thereof;

FIG. 6 is a top plan view thereof; and,

FIG. 7 is a bottom plan view thereof.

The broken lines in the drawings illustrate the portions of the soap/lotion dispenser that form no part of the claim. The pump portion of the soap/lotion dispenser is not included claimed.

1 Claim, 7 Drawing Sheets

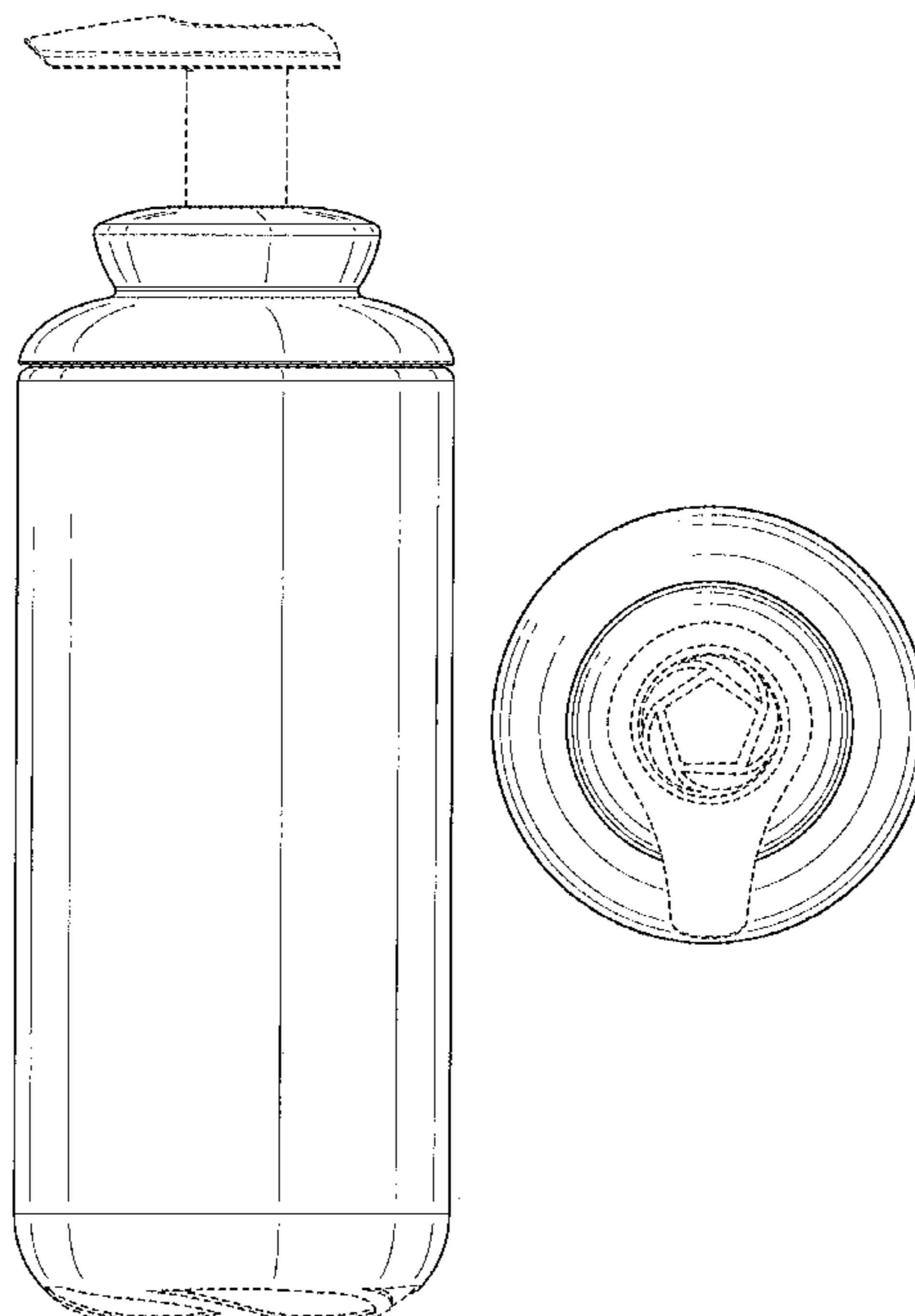

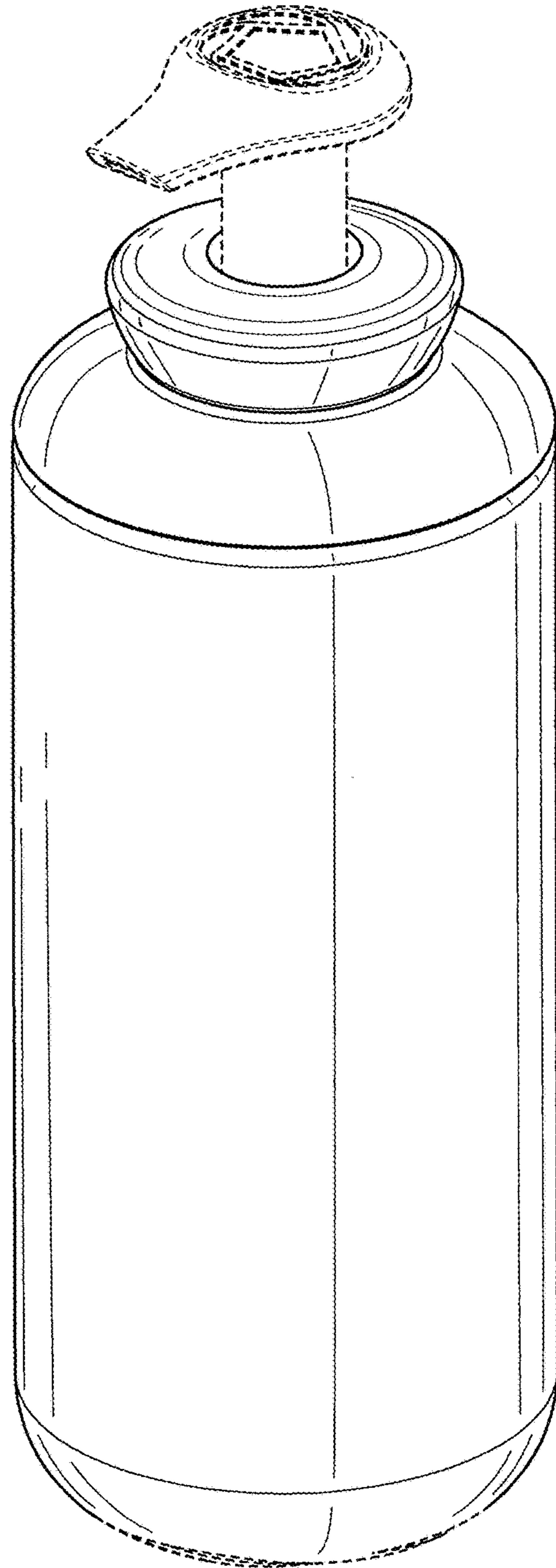

FIG. 1

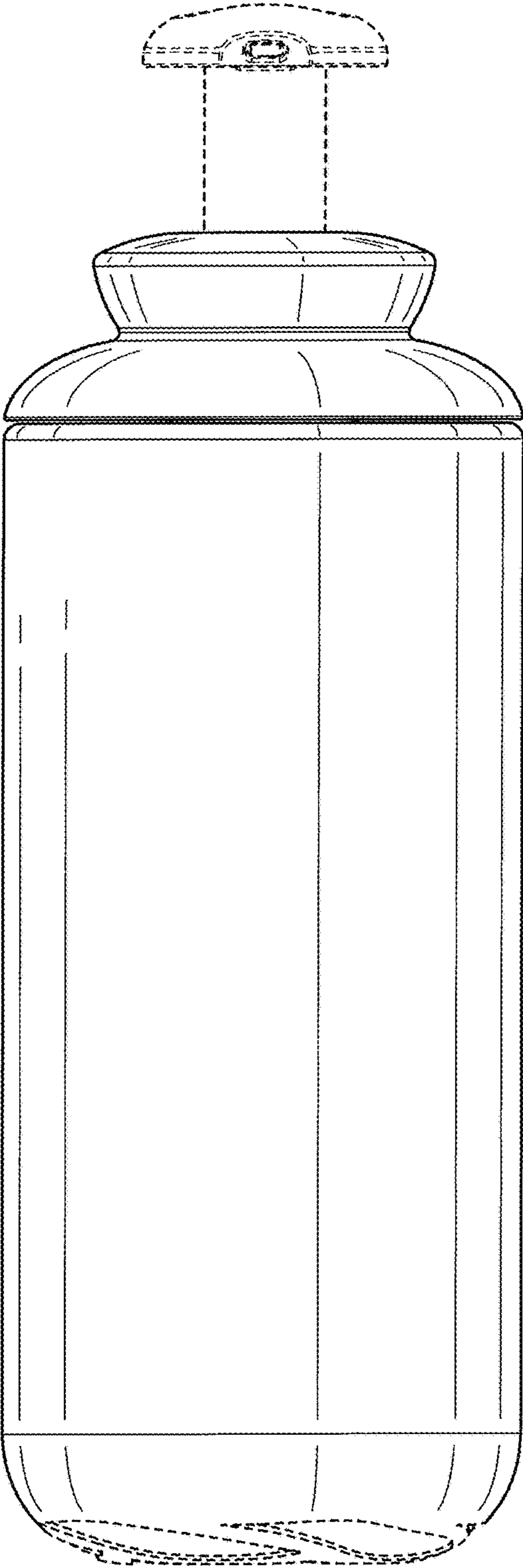

FIG. 2

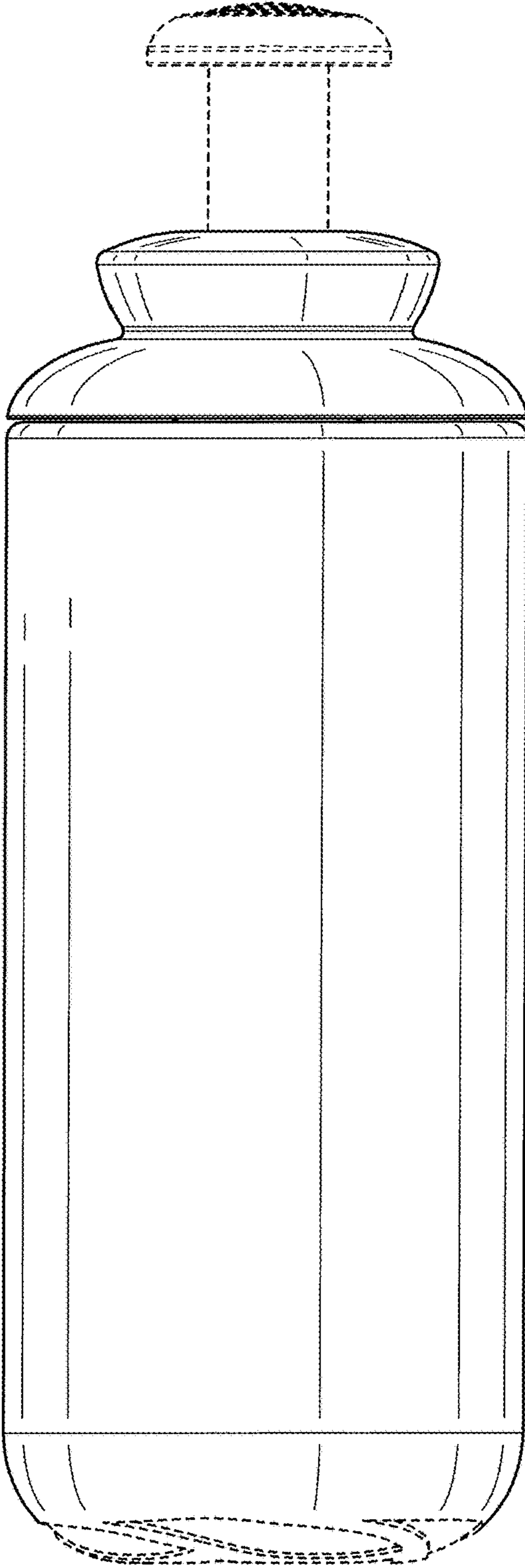

FIG. 3

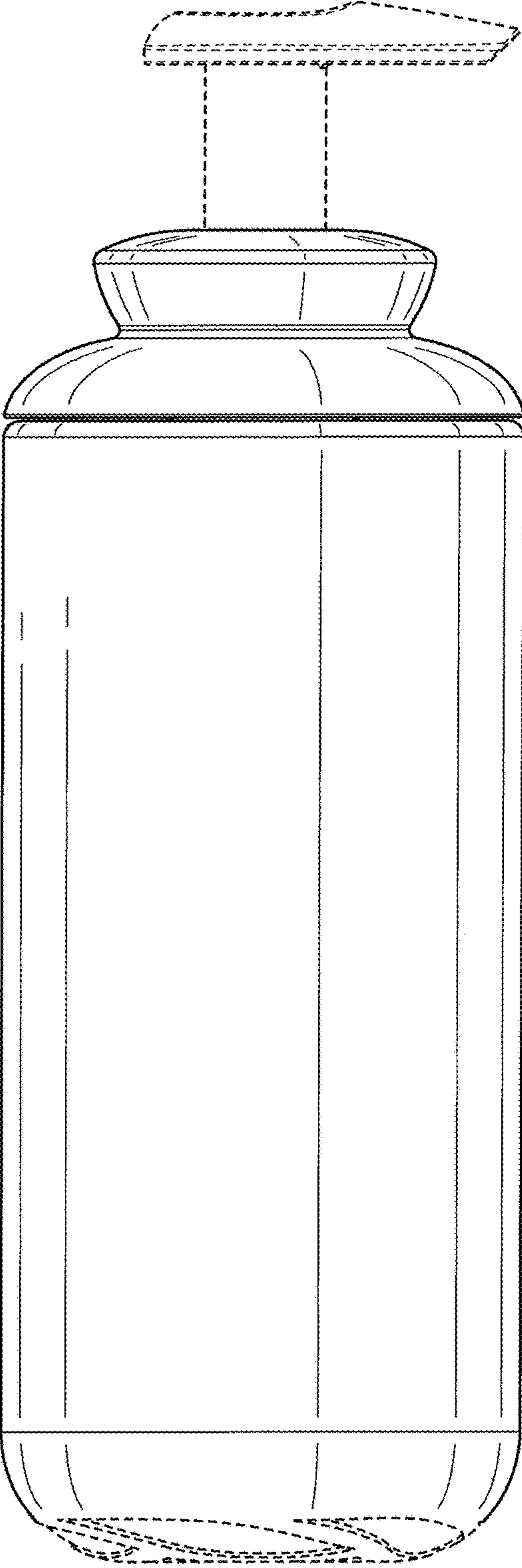

FIG. 4

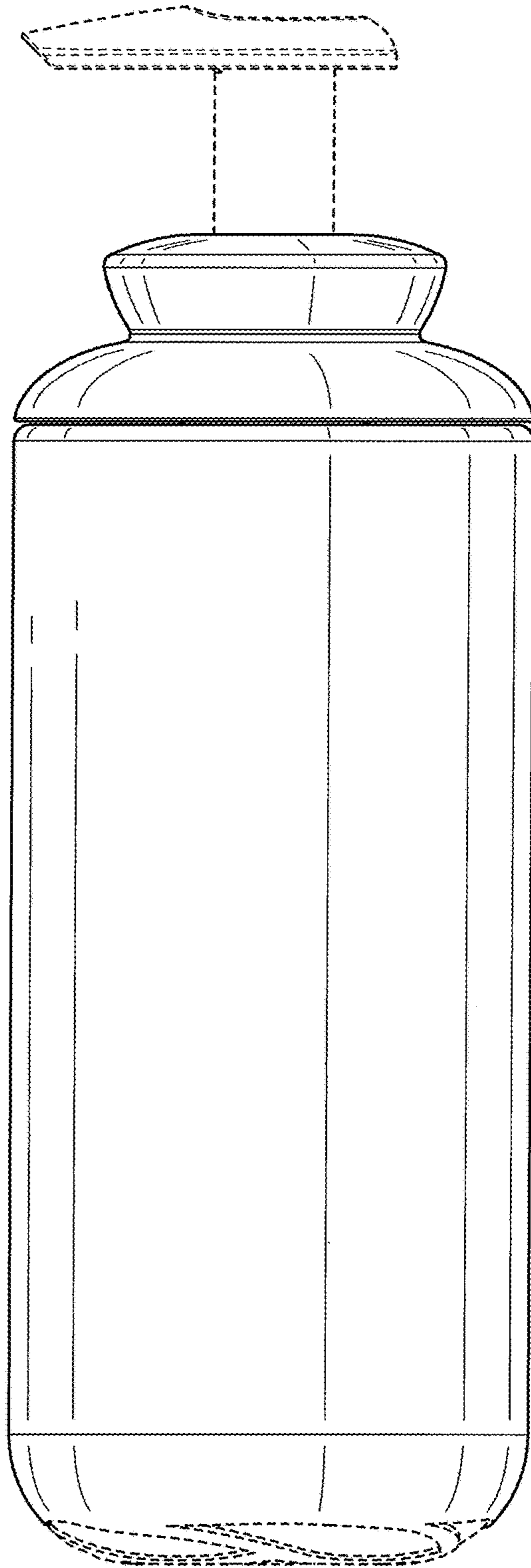

FIG. 5

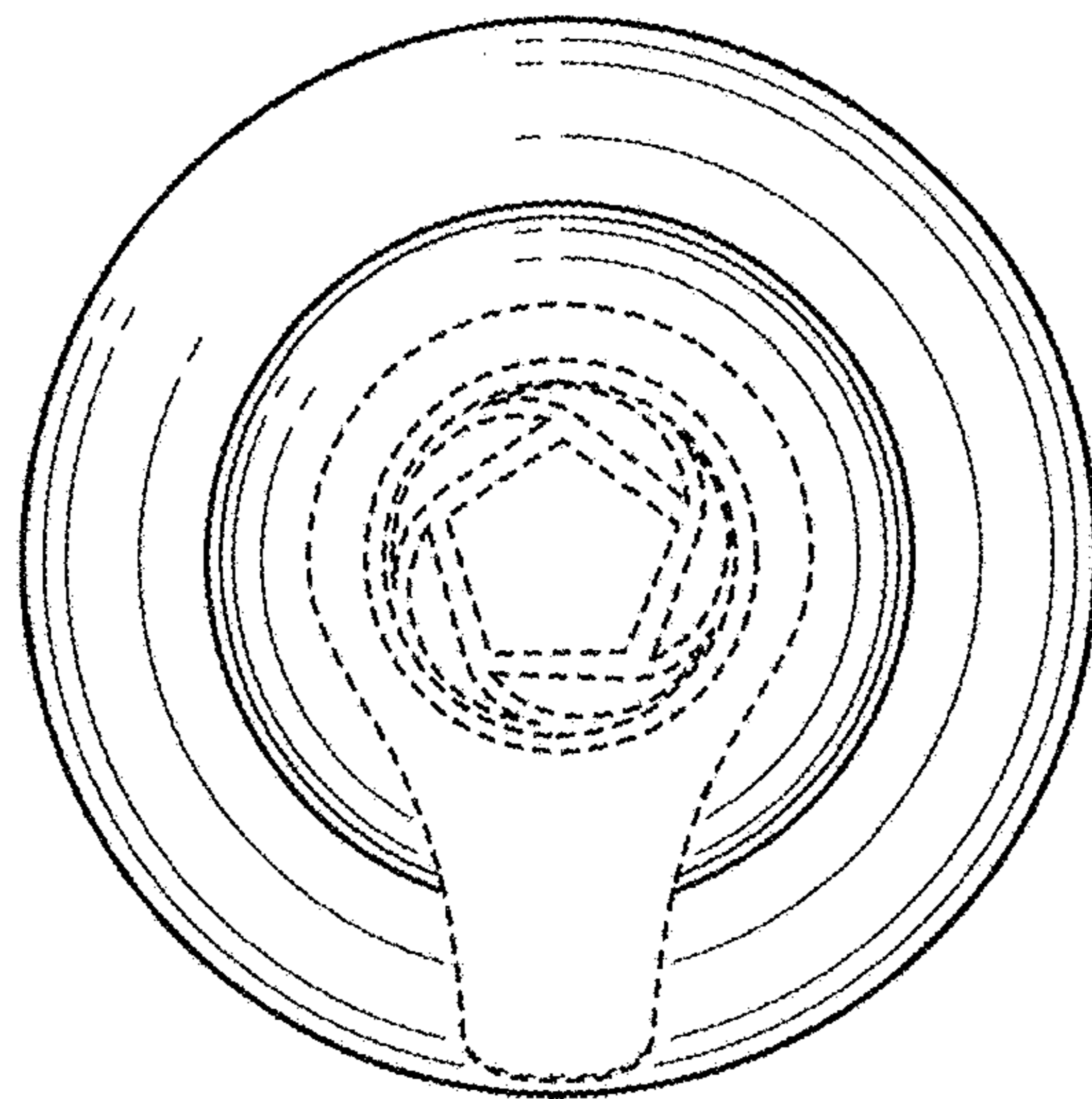

FIG. 6

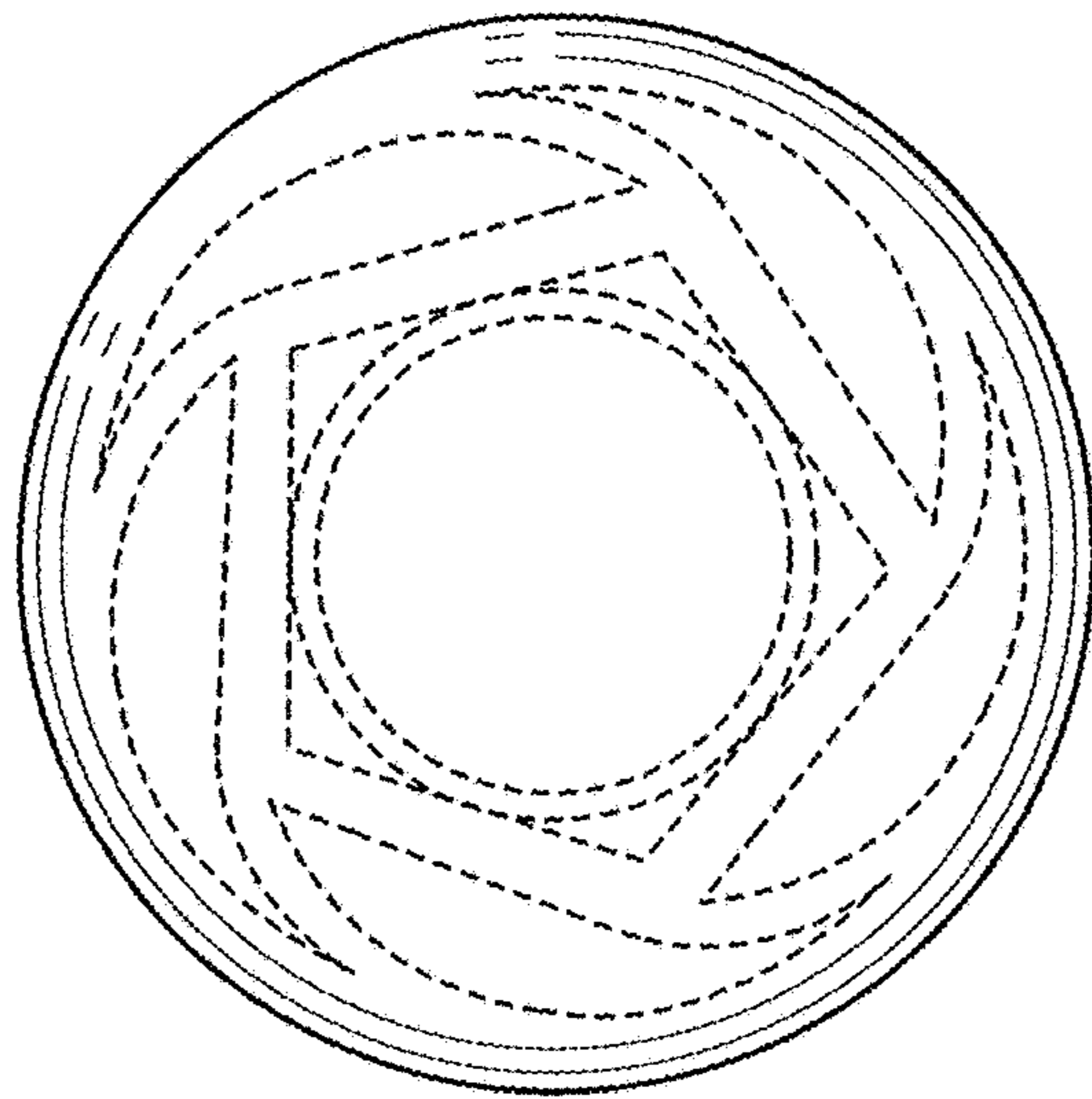

FIG. 7