



US00D863961S

(12) **United States Design Patent** (10) **Patent No.:** **US D863,961 S**  
**Nervo et al.** (45) **Date of Patent:** **\*\* Oct. 22, 2019**

(54) **LIQUID CONTAINER BOTTLE**

(71) Applicant: **BONA AB**, Malmo (SE)

(72) Inventors: **Paulo Nervo**, AE Hoogeloon (NL);  
**Dennis van Melick**, HK Eindhoven (NL)

(73) Assignee: **BONA AB**, Malmo (SE)

(\*\*) Term: **15 Years**

(21) Appl. No.: **29/626,903**

(22) Filed: **Nov. 21, 2017**

**Related U.S. Application Data**

(62) Division of application No. 29/584,536, filed on Nov. 15, 2016, now Pat. No. Des. 815,949.

(51) **LOC (12) Cl.** ..... **09-07**

(52) **U.S. Cl.**  
USPC ..... **D9/447**

(58) **Field of Classification Search**  
USPC ..... D9/434-435, 439, 447, 449, 450, 452, D9/454, 516, 520, 522-524, 528-531, D9/541-544, 549-551, 558-560, 563, D9/565-566, 571-575, 682, 686, 687, D9/693-694, 715, 719; D7/300, 300.1, D7/316, 317, 598; D23/211, 225  
CPC ... B65D 1/00; B65D 1/02; B65D 1/12; B65D 1/18; B65D 1/20; B65D 1/0223; B65D 23/00; B65D 21/0237; B65D 2501/0009; B65D 2501/0081  
See application file for complete search history.

(56) **References Cited**

**U.S. PATENT DOCUMENTS**

D381,910 S \* 8/1997 Sayers ..... D9/447  
D511,095 S \* 11/2005 Auer ..... D9/435  
D540,677 S \* 4/2007 Stull ..... D9/447  
D558,517 S \* 1/2008 Larkin ..... D7/401.1  
D604,613 S \* 11/2009 Garboni ..... D9/447

D634,628 S \* 3/2011 Goto ..... D7/900  
D635,024 S \* 3/2011 Stolle ..... D9/435  
D635,026 S \* 3/2011 Stolle ..... D9/435  
D640,134 S \* 6/2011 Rognard ..... D9/447  
D640,555 S \* 6/2011 Williams ..... D9/447  
D692,270 S \* 10/2013 Lapsker ..... D7/392.1  
D739,183 S \* 9/2015 Lane ..... D7/605  
D743,255 S \* 11/2015 Niggemyer ..... D9/435  
D743,790 S \* 11/2015 Hussain ..... D9/447  
D763,078 S \* 8/2016 Roy ..... D9/434

(Continued)

**FOREIGN PATENT DOCUMENTS**

CN 201730243025 \* 6/2017

**OTHER PUBLICATIONS**

Bona Hardwood Floor Cleaner Cartridge, 34 oz. Online, published date Dec. 18, 2013. Retrieved on Feb. 4, 2019 from URL: <https://www.amazon.com/Bona-Hardwood-Floor-Cleaner-Cartridge/dp/B0016LZUW0>.\*

*Primary Examiner* — Susan Bennett Hattan

*Assistant Examiner* — Omeed Agilee

(74) *Attorney, Agent, or Firm* — William P. O'Meara; Cochran Freund & Young LLC

(57) **CLAIM**

The ornamental design for a liquid container bottle, as shown and described.

**DESCRIPTION**

FIG. 1 is a rear isometric view of a liquid container bottle showing our new design;  
FIG. 2 is a top isometric view thereof;  
FIG. 3 is a rear elevation view thereof;  
FIG. 4 is a front elevation view thereof;  
FIG. 5 is a right side elevation view thereof of which the left side elevation view is a mirror image;  
FIG. 6 is a top plan view thereof; and,  
FIG. 7 is a bottom plan view thereof.

**1 Claim, 3 Drawing Sheets**

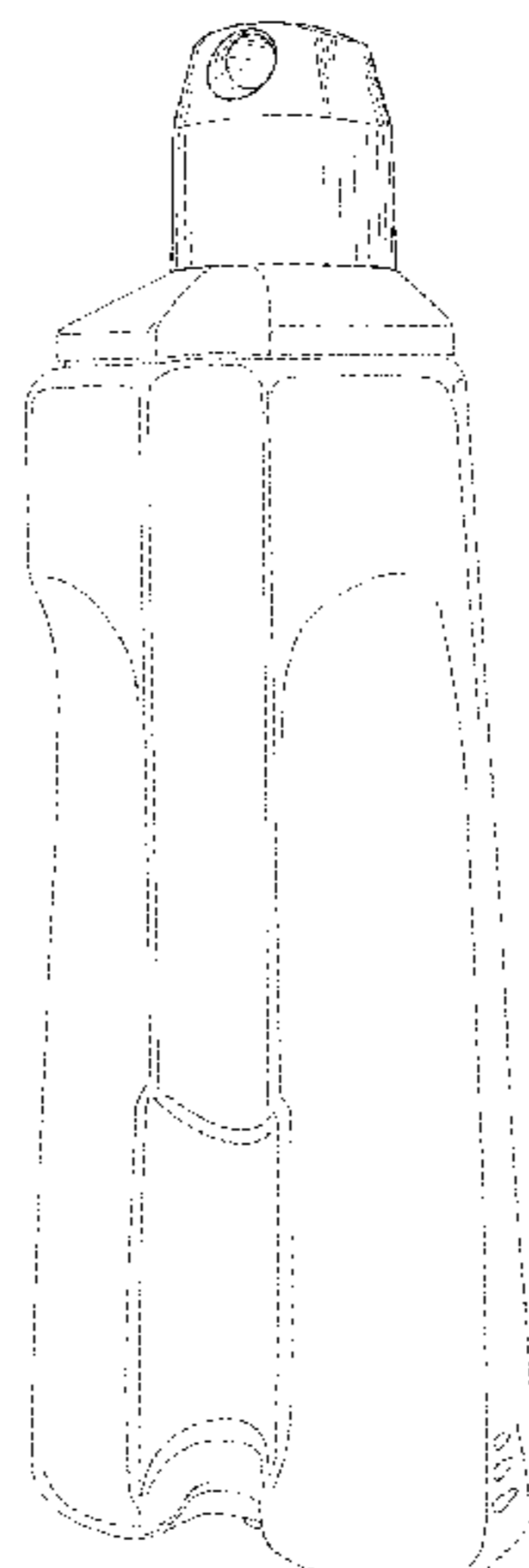

(56)

**References Cited**

U.S. PATENT DOCUMENTS

D775,950 S *	1/2017	Rognard .....	D9/434
D780,578 S *	3/2017	Lane .....	D7/396.2
D794,450 S *	8/2017	Moreaux .....	D9/434
D795,065 S *	8/2017	Son .....	D9/442
D815,533 S *	4/2018	Nervo .....	D9/522
D815,949 S *	4/2018	Nervo .....	D9/522

\* cited by examiner

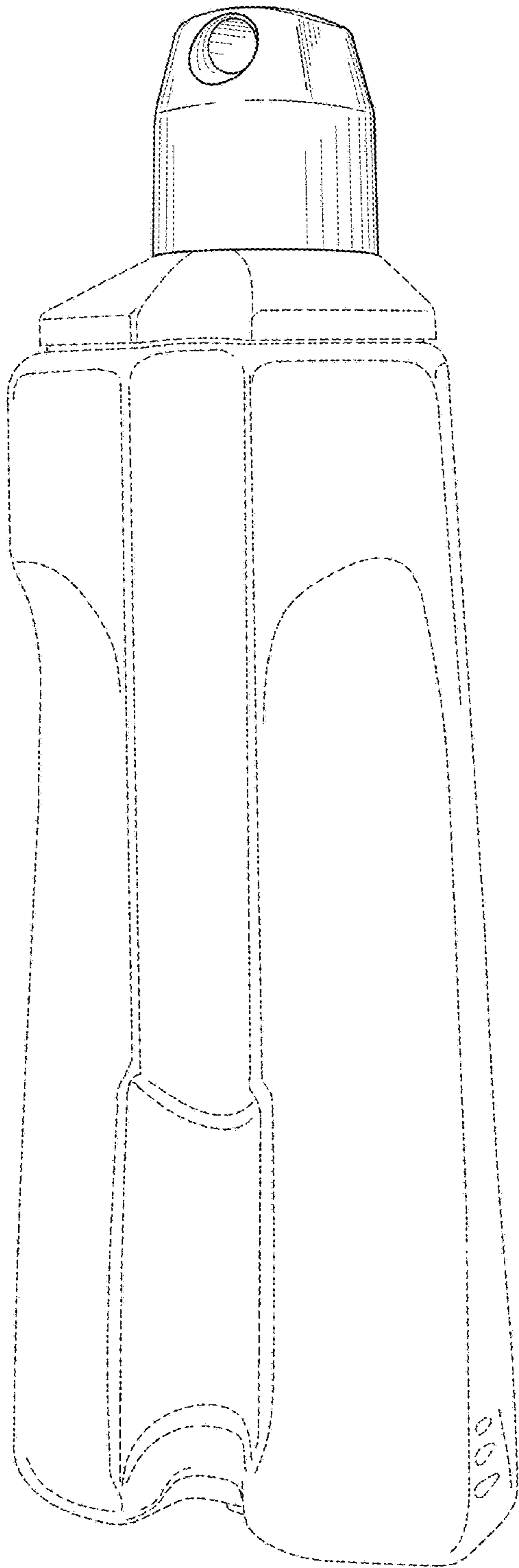

FIG. 1

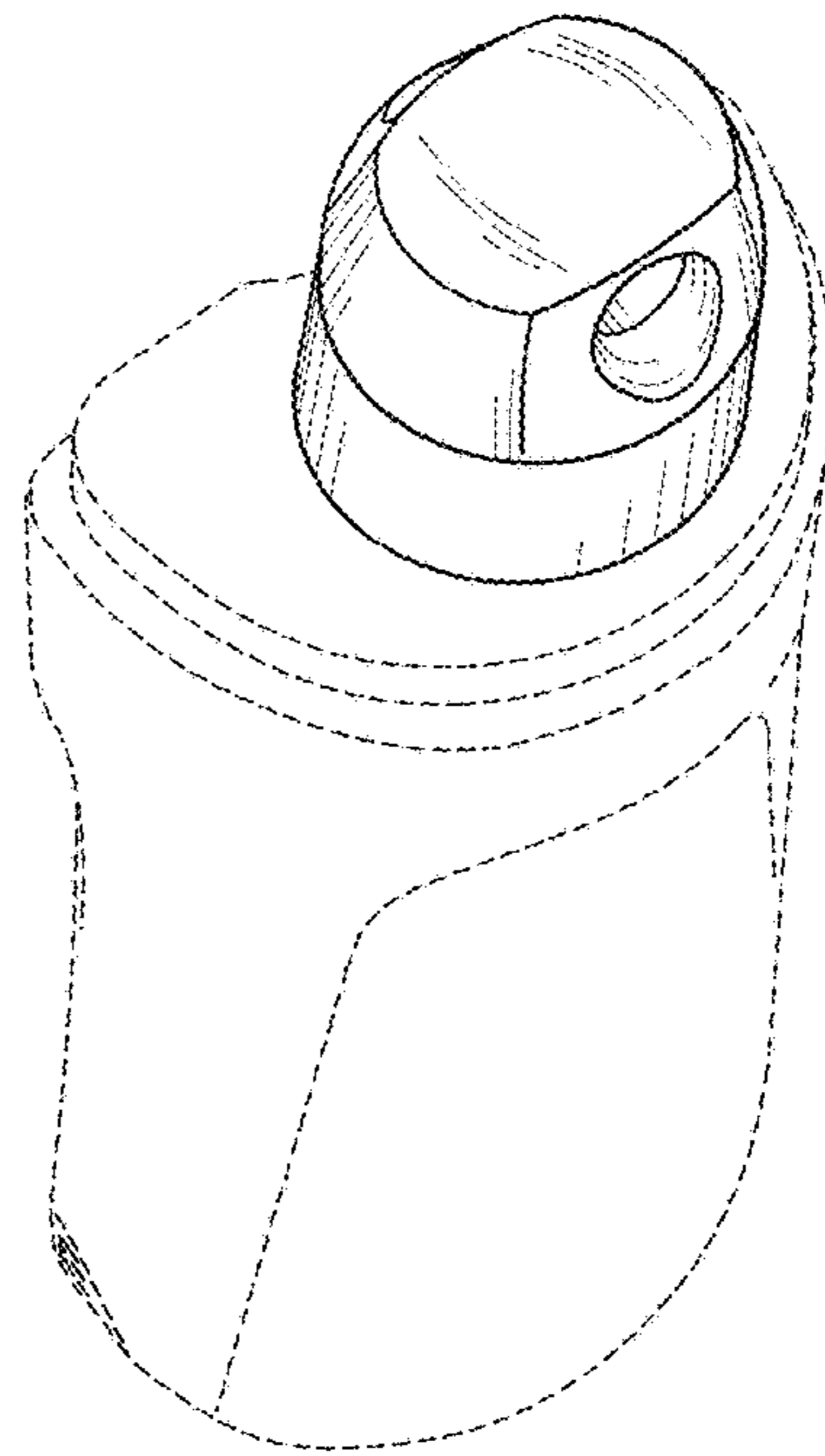

FIG. 2

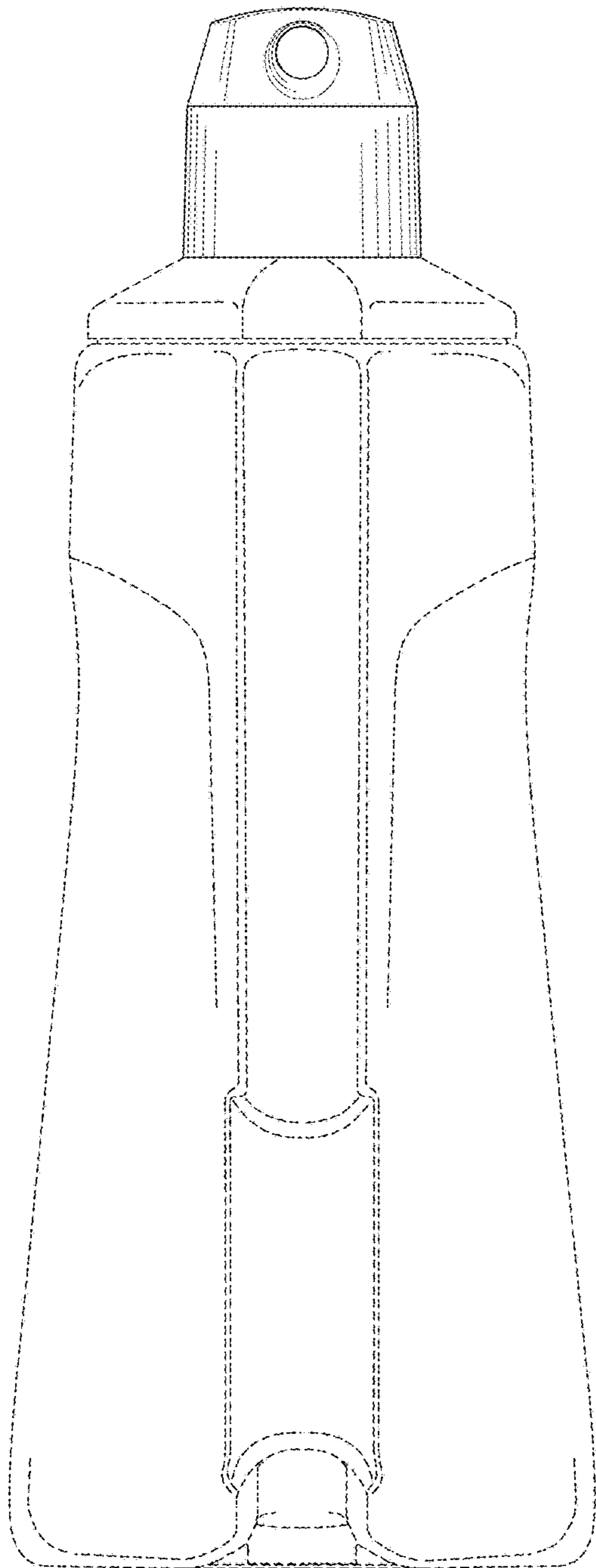

FIG. 3

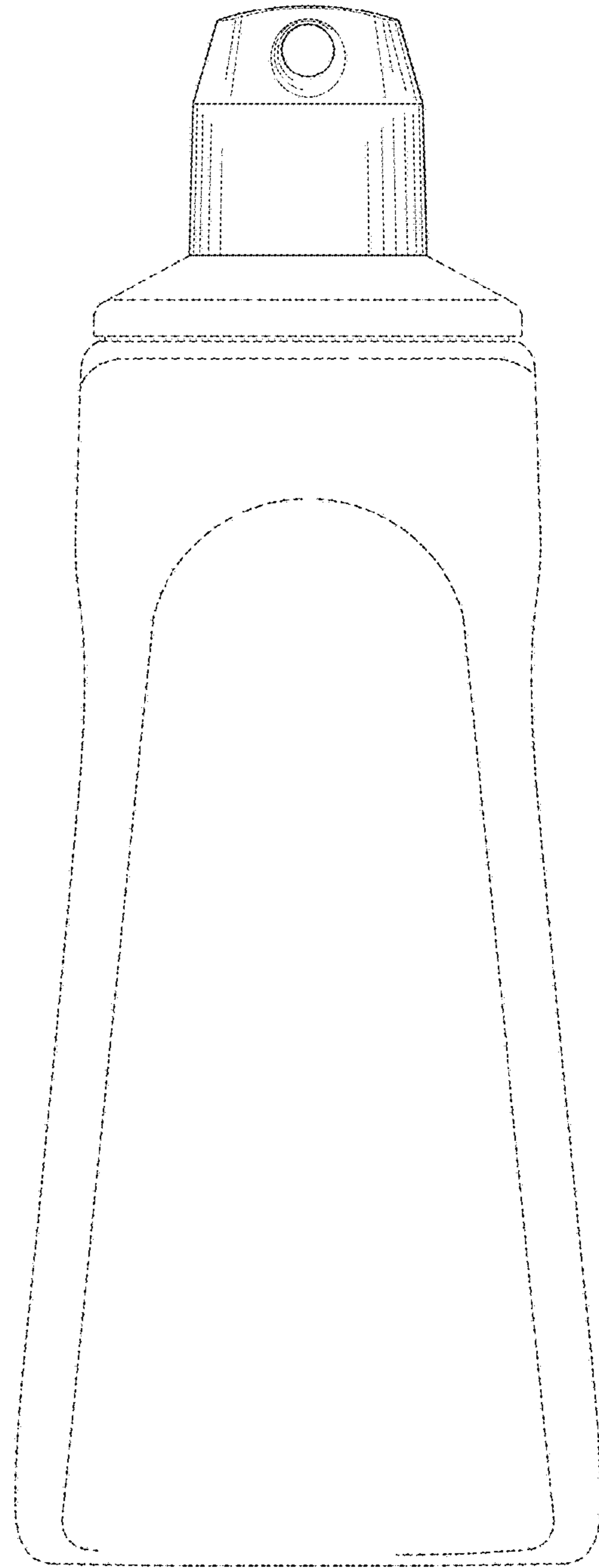

FIG. 4

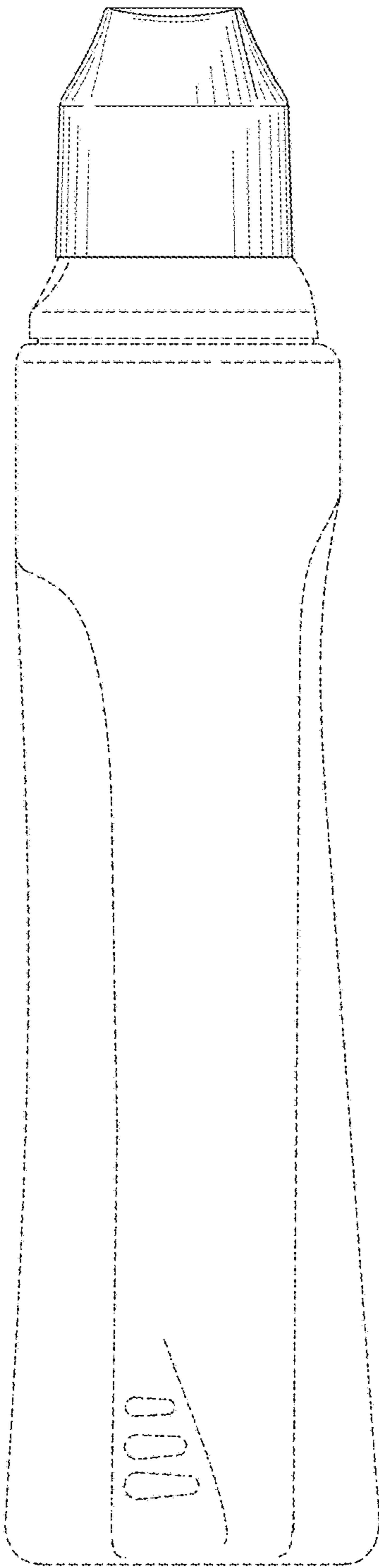

FIG. 5

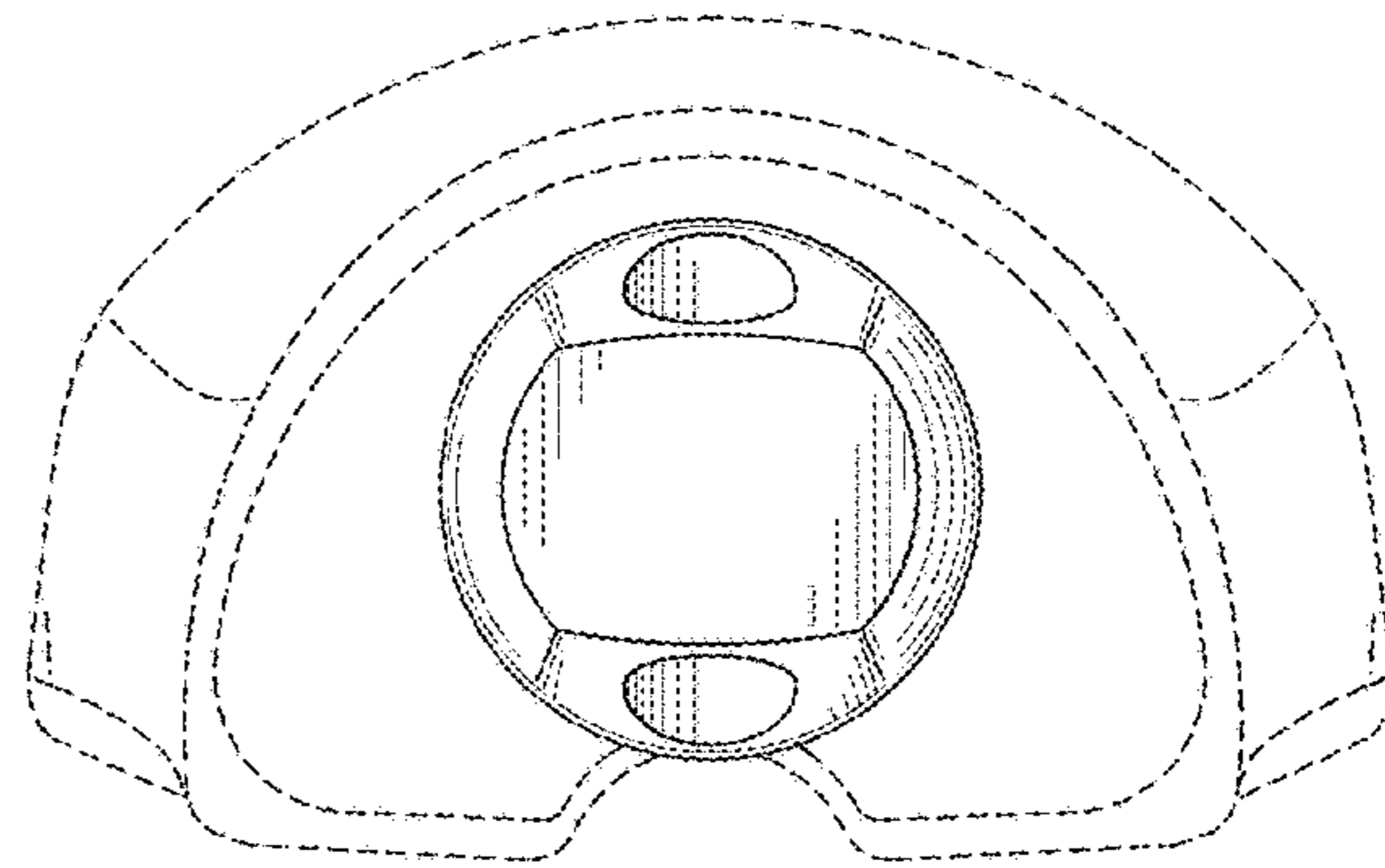

FIG. 6

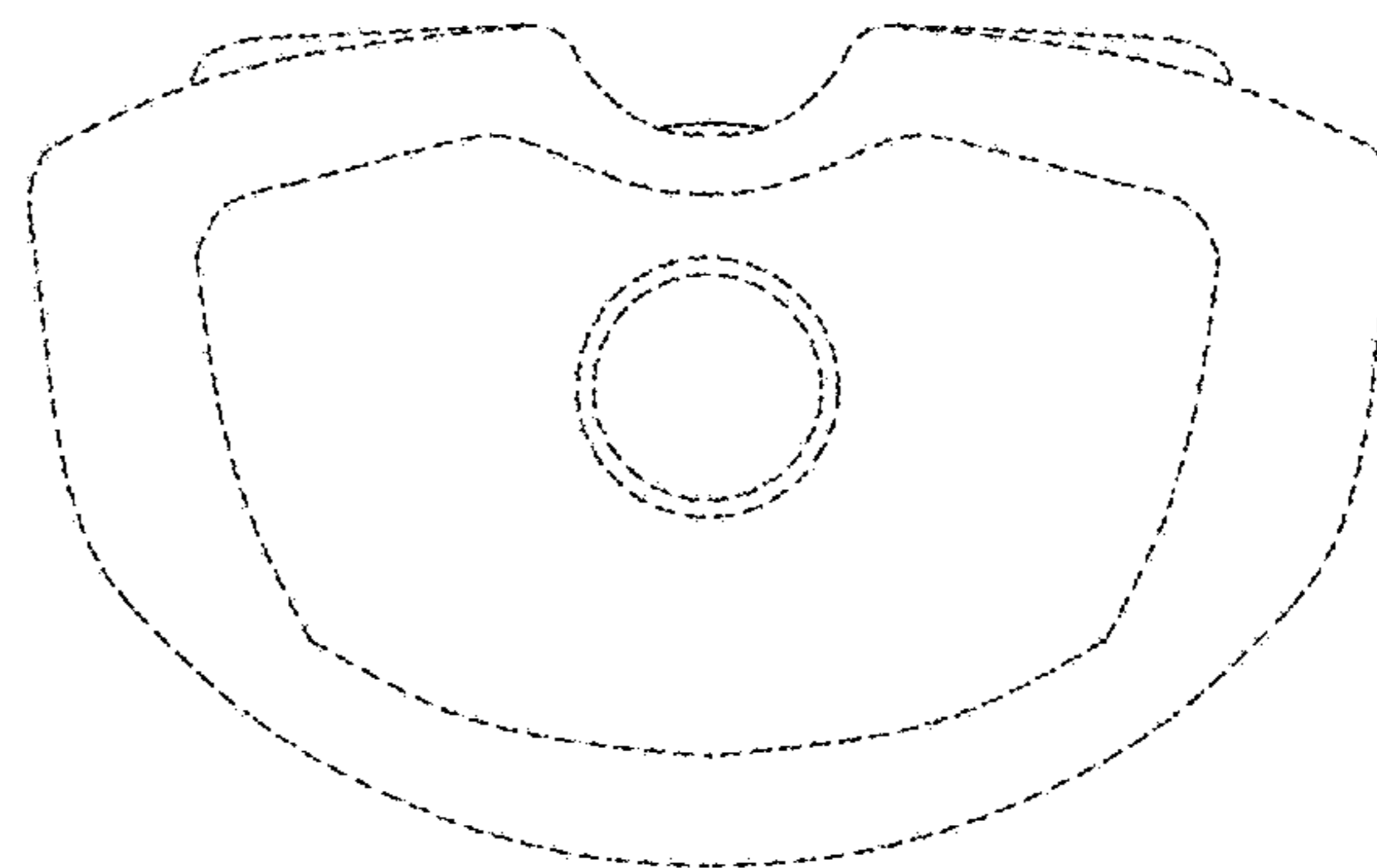

FIG. 7