



US00D863959S

(12) **United States Design Patent** (10) **Patent No.:** **US D863,959 S**
Larminaux et al. (45) **Date of Patent:** **** Oct. 22, 2019**

(54) **BOTTLE STOPPER**

- (71) Applicant: **Patron Spirits International AG**,
Schaffhausen (CH)
- (72) Inventors: **Marc Larminaux**, Paris (FR);
Gabrielle Renee Rein, Long Island
City, NY (US)
- (73) Assignee: **PATRON SPIRITS**
INTERNATIONAL AG, Schaffhausen
(CH)
- (**) Term: **15 Years**
- (21) Appl. No.: **29/655,044**
- (22) Filed: **Jun. 29, 2018**

Related U.S. Application Data

- (62) Division of application No. 29/601,427, filed on Apr. 21, 2017, now Pat. No. Des. 823,118, which is a division of application No. 29/542,645, filed on Oct. 15, 2015, now Pat. No. Des. 785,460.
- (51) **LOC (12) Cl.** **09-07**
- (52) **U.S. Cl.**
USPC **D9/439**
- (58) **Field of Classification Search**
USPC D9/600, 655-664, 500-504, 516,
D9/537-561, 563-566, 571-575, 434,
D9/439-441; 215/381-384, 400;
206/457, 459.5, 527; D7/514-517, 519,
D7/619.2, 628, 392.1
CPC A63K 33/16; B65D 81/36; B65D 81/60;
B65D 81/365; B65D 81/366; B65D
81/368; B65D 67/00; B65D 2203/00;
B65D 2203/02; B65D 5/42; B65D
5/4208; B65D 77/00
- See application file for complete search history.

(56) **References Cited**

U.S. PATENT DOCUMENTS

D72,410 S	4/1927	Delaize	
D76,976 S	11/1928	Applebaum	
D93,949 S	11/1934	Steelman	
D94,101 S	12/1934	Spence	
D100,230 S	6/1936	Steelman	
D100,424 S	7/1936	Guerlain	
D101,392 S	9/1936	Oestreich	
D104,584 S *	5/1937	Samstag	D9/439
D112,706 S	12/1938	Smith	
D116,048 S	8/1939	Noble	
D117,610 S	11/1939	D'Addario	
D124,920 S	1/1941	Heuisler	
D146,351 S	2/1947	Dunnock	
D167,086 S *	6/1952	Kaufer	D9/439
D223,147 S *	3/1972	Northgrave et al.	D9/439
D227,749 S *	7/1973	Plummer	D9/545
D260,969 S *	9/1981	Goettner	D9/439
D268,329 S	3/1983	Cointreau	
D280,708 S	9/1985	Yoshimura	
D304,298 S	10/1989	Bannister	
D339,296 S	9/1993	Bompard	

(Continued)

Primary Examiner — Sandra L Morris

(74) *Attorney, Agent, or Firm* — Pearne & Gordon LLP

(57) **CLAIM**

The ornamental design for a bottle stopper, as shown and described.

DESCRIPTION

FIG. 1 is a perspective view of a bottle stopper, showing our new design;
 FIG. 2 is a front elevational view thereof;
 FIG. 3 is a rear elevational view thereof;
 FIG. 4 is a left side elevational view thereof;
 FIG. 5 is a right side elevational view thereof;
 FIG. 6 is a top plan view thereof; and,
 FIG. 7 is a bottom plan view thereof.

1 Claim, 4 Drawing Sheets

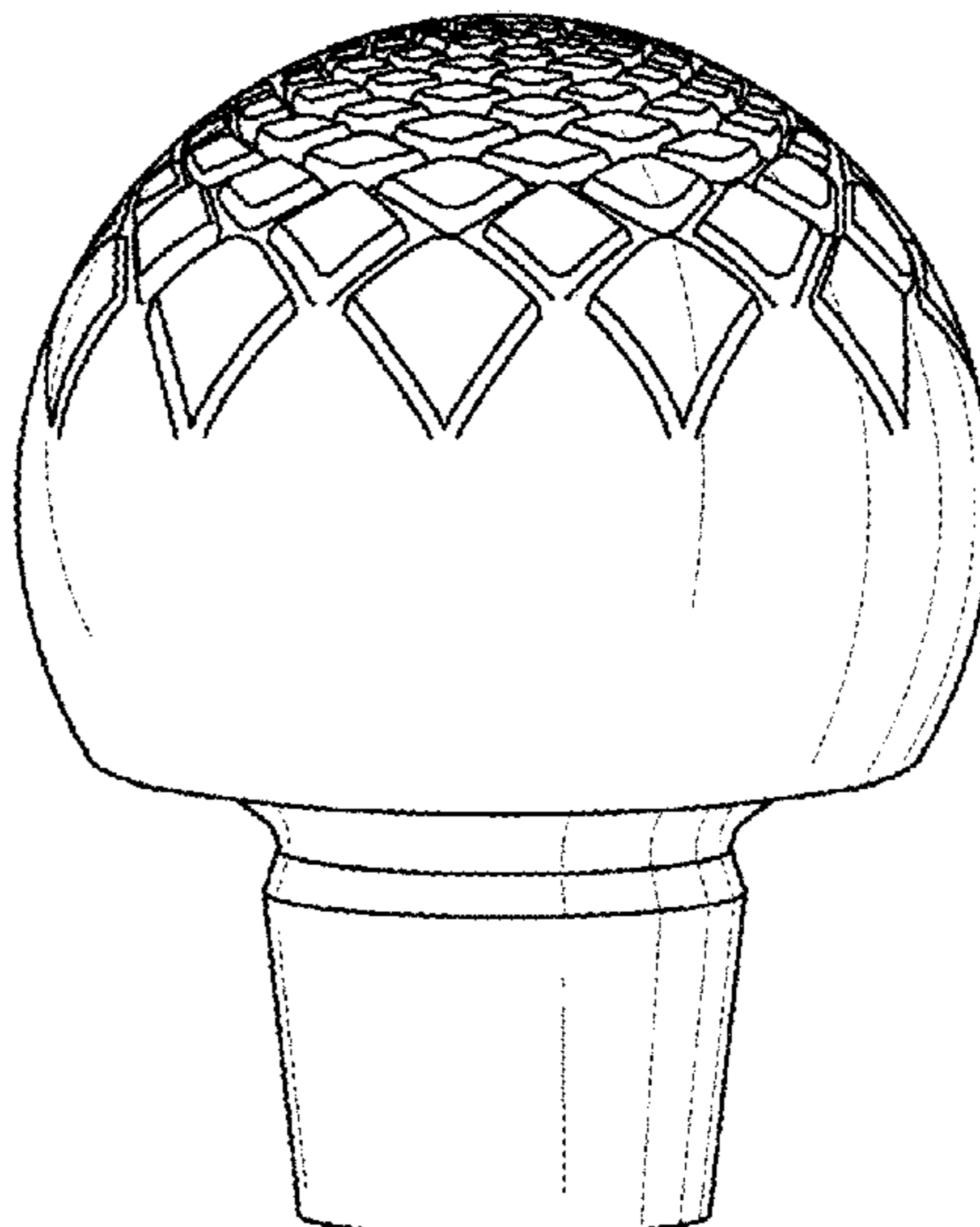

(56)

References Cited

U.S. PATENT DOCUMENTS

D353,324 S	12/1994	Rice, III	
D355,602 S	2/1995	Buettner	
D367,011 S	2/1996	Lilly	
D467,181 S	12/2002	Versace	
D472,469 S *	4/2003	Versace	D9/439
D519,845 S	5/2006	Ortiz	
D530,211 S	10/2006	Lloyd	
D545,676 S *	7/2007	Rica	D9/439
D547,670 S	7/2007	Heisner	
D549,577 S *	8/2007	Schactner	D9/439
D551,548 S *	9/2007	Didier	D9/439
D559,113 S	1/2008	Brown	
D581,803 S	12/2008	Lepoitevin	
D601,430 S	10/2009	Fischer	
D605,948 S	12/2009	Sposato	
D613,178 S	4/2010	Kuzma	
D614,503 S	4/2010	Kuzma	
D619,016 S	7/2010	Malanchino	
D624,723 S	10/2010	Raghunathan	
D638,706 S *	5/2011	de Bashmakoff	D9/441
D642,914 S *	8/2011	Dumas	D9/439
D643,719 S *	8/2011	Chiott	D9/439
D658,068 S	4/2012	Nawrocki	
D681,455 S *	5/2013	Meisenheimer	D9/439
D682,704 S	5/2013	Reynolds	
D693,693 S	11/2013	Sanchez	
D700,845 S	3/2014	Fujimoto	
D727,166 S	4/2015	Tariko	
D729,628 S	5/2015	Gordon	
D737,146 S	8/2015	Kramer	
D742,748 S	11/2015	Kuzma	
D749,424 S	2/2016	Carroll	
D751,393 S *	3/2016	Lynd	D9/439
D755,635 S	5/2016	Minorini	
D764,298 S	8/2016	Gordon	

* cited by examiner

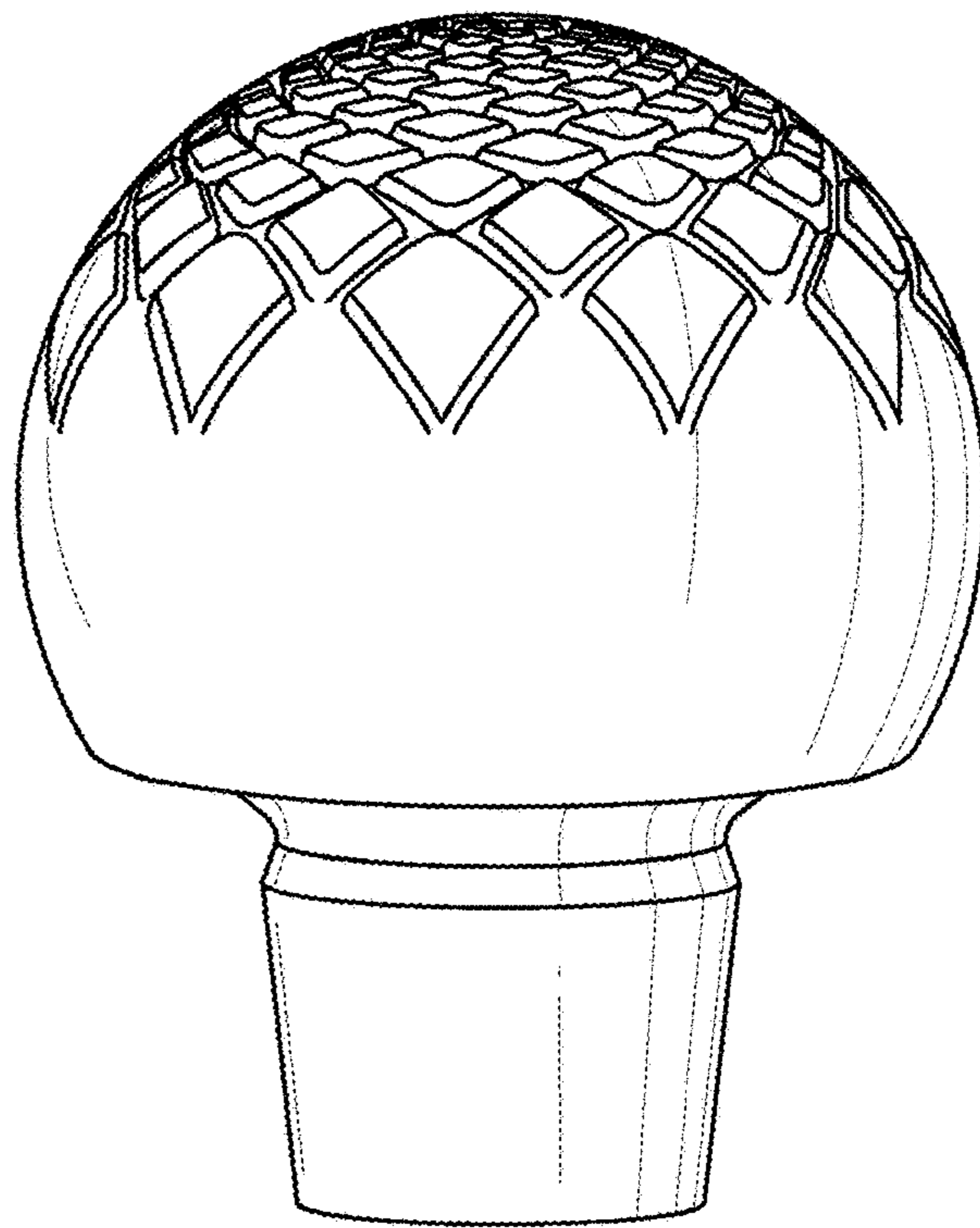

FIG. 1

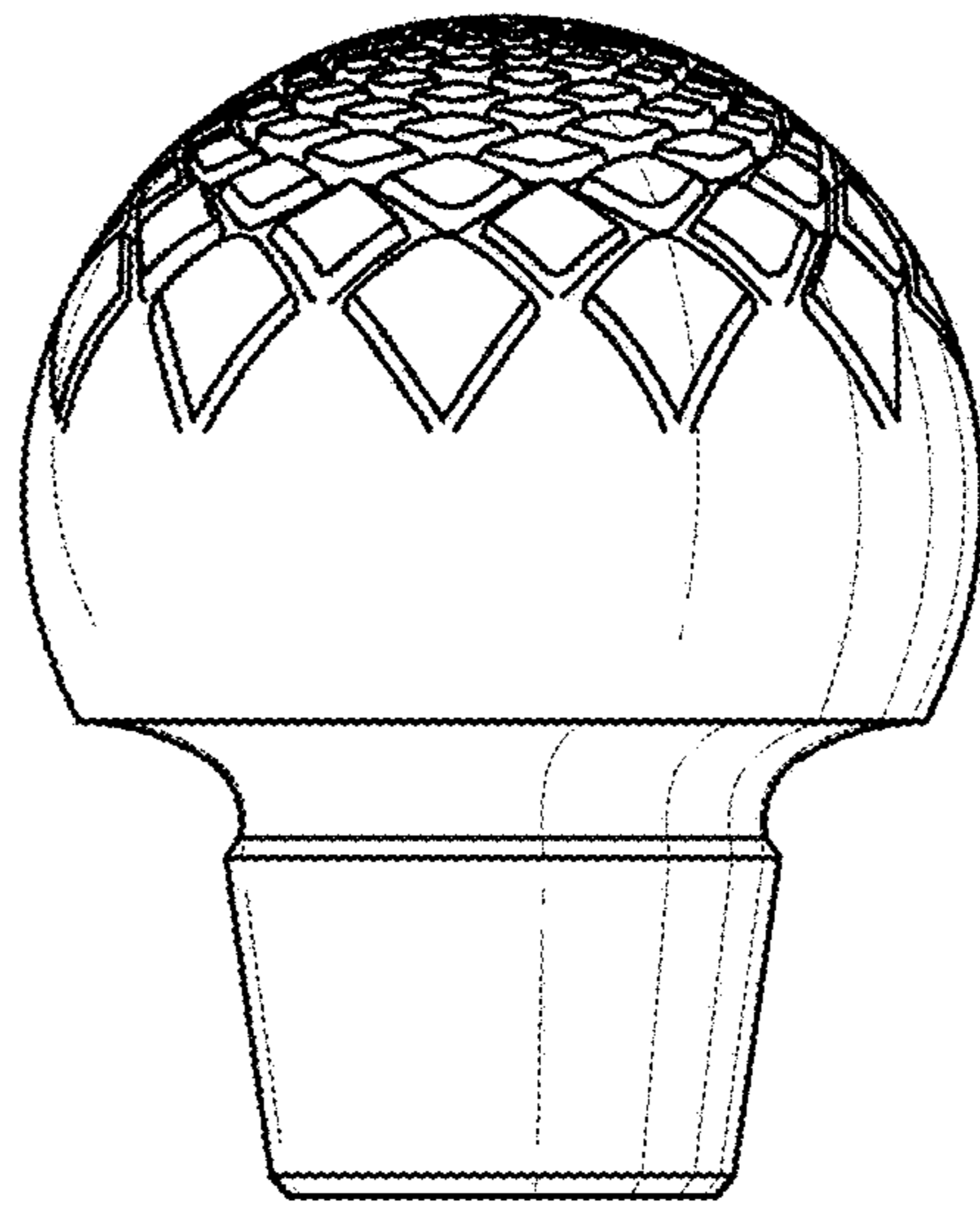

FIG. 2

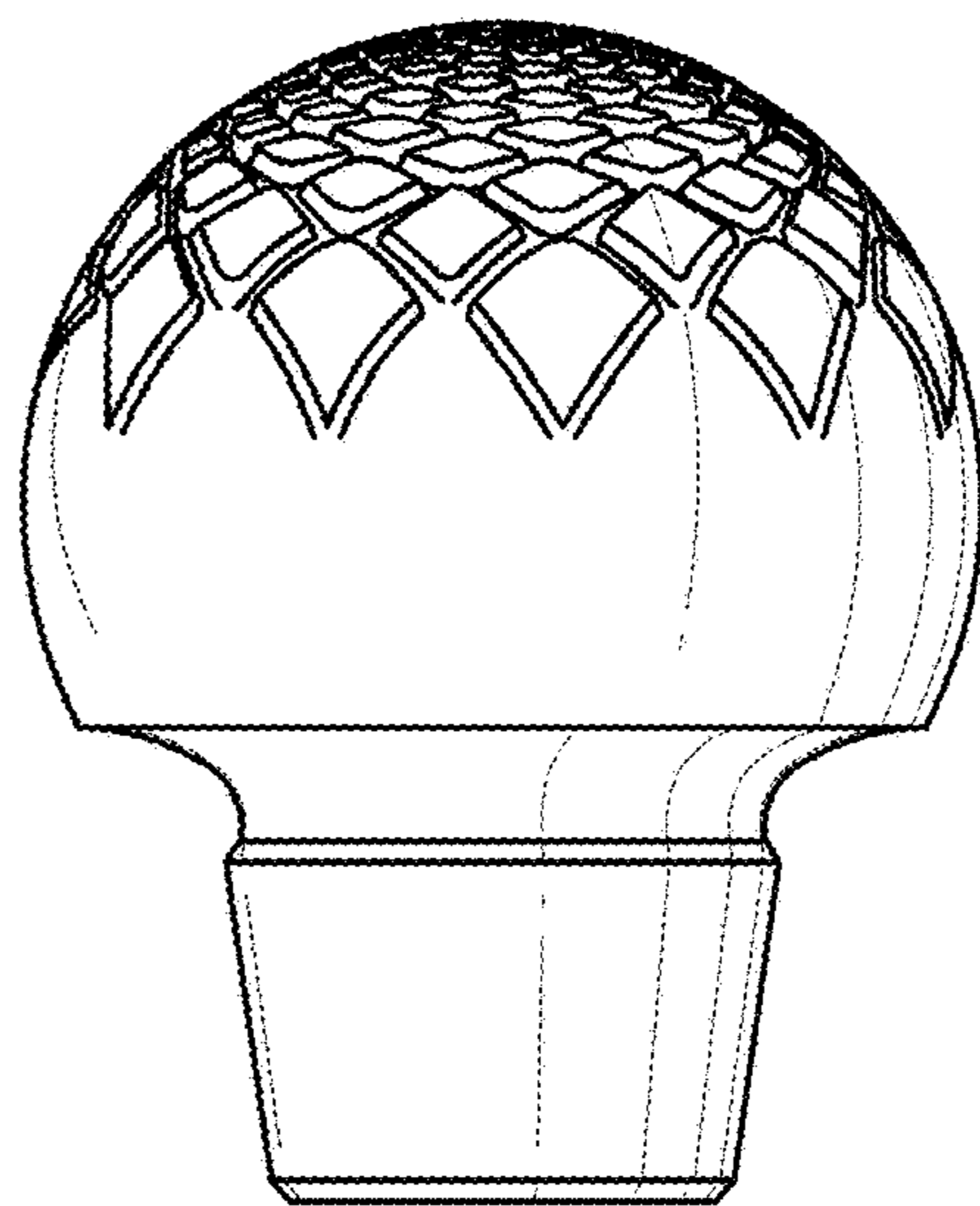

FIG. 3

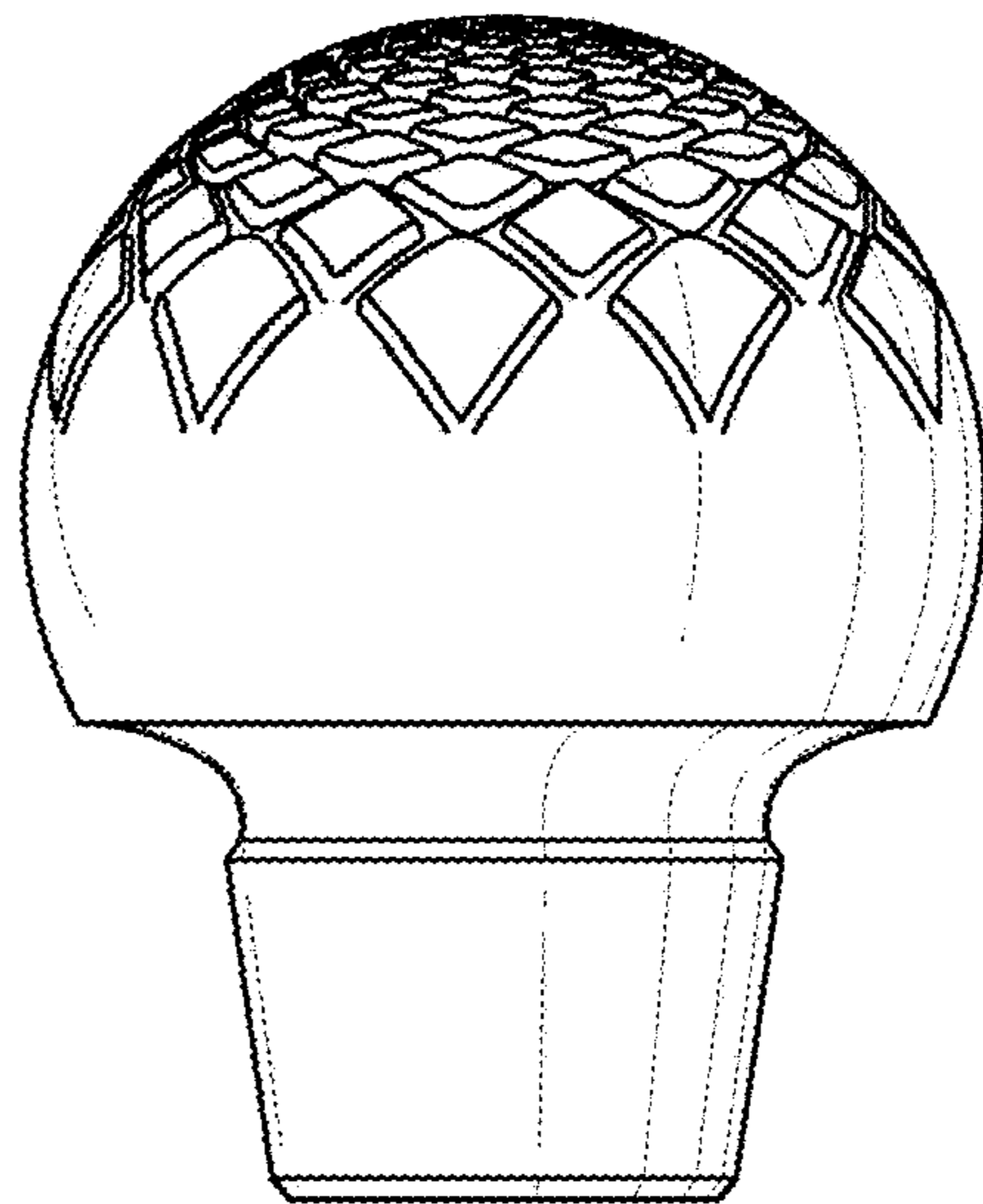

FIG. 4

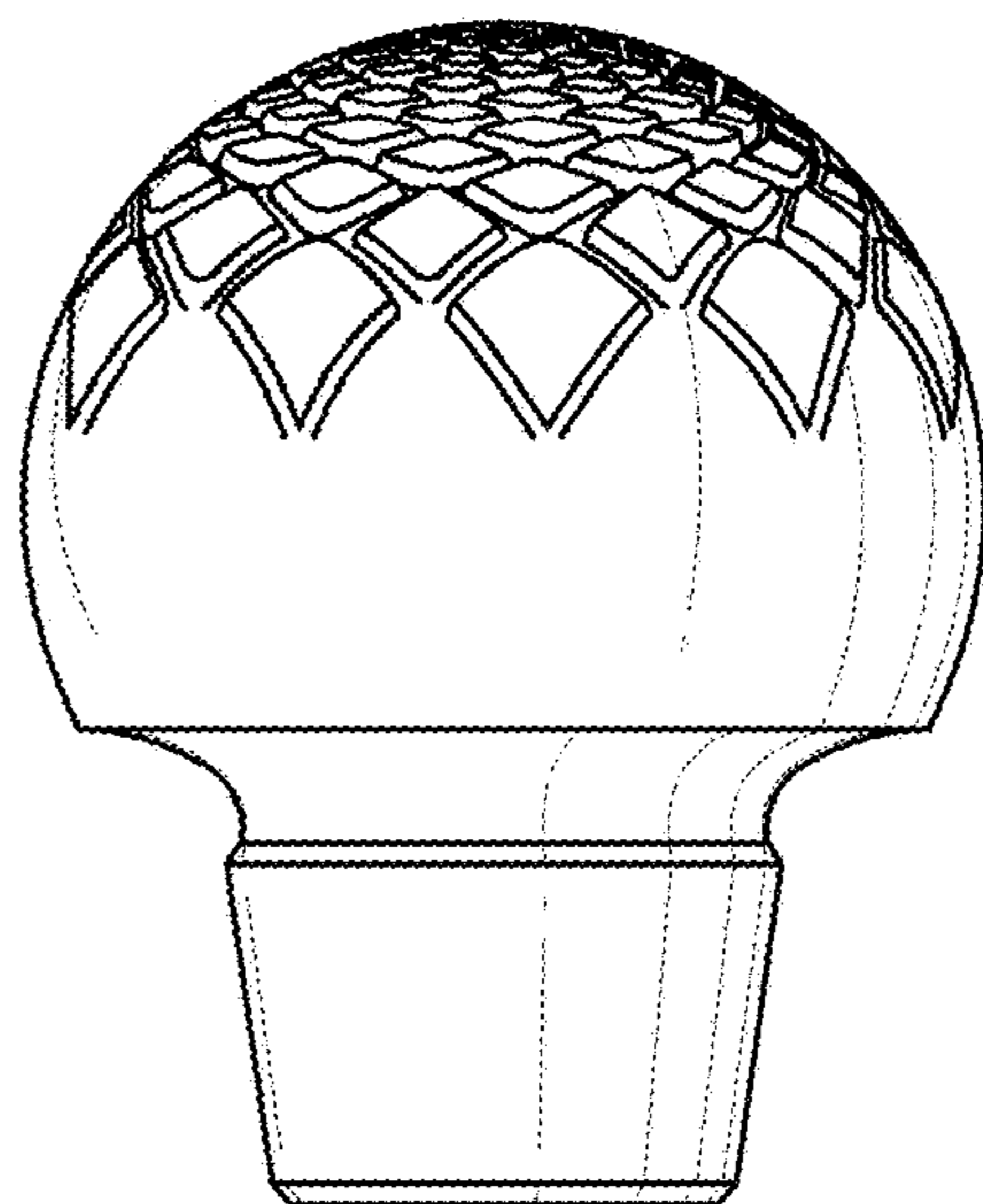

FIG. 5

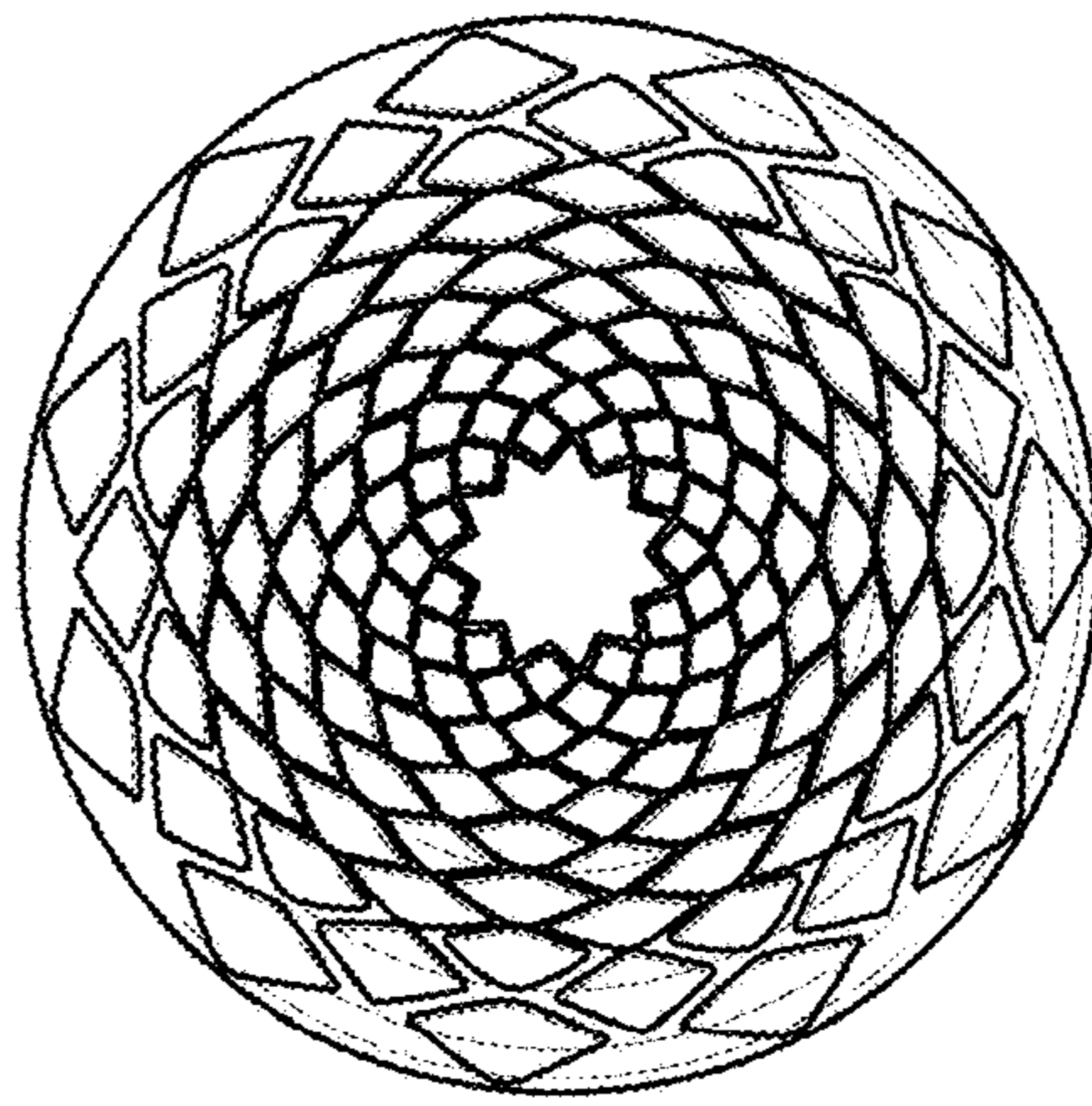

FIG. 6

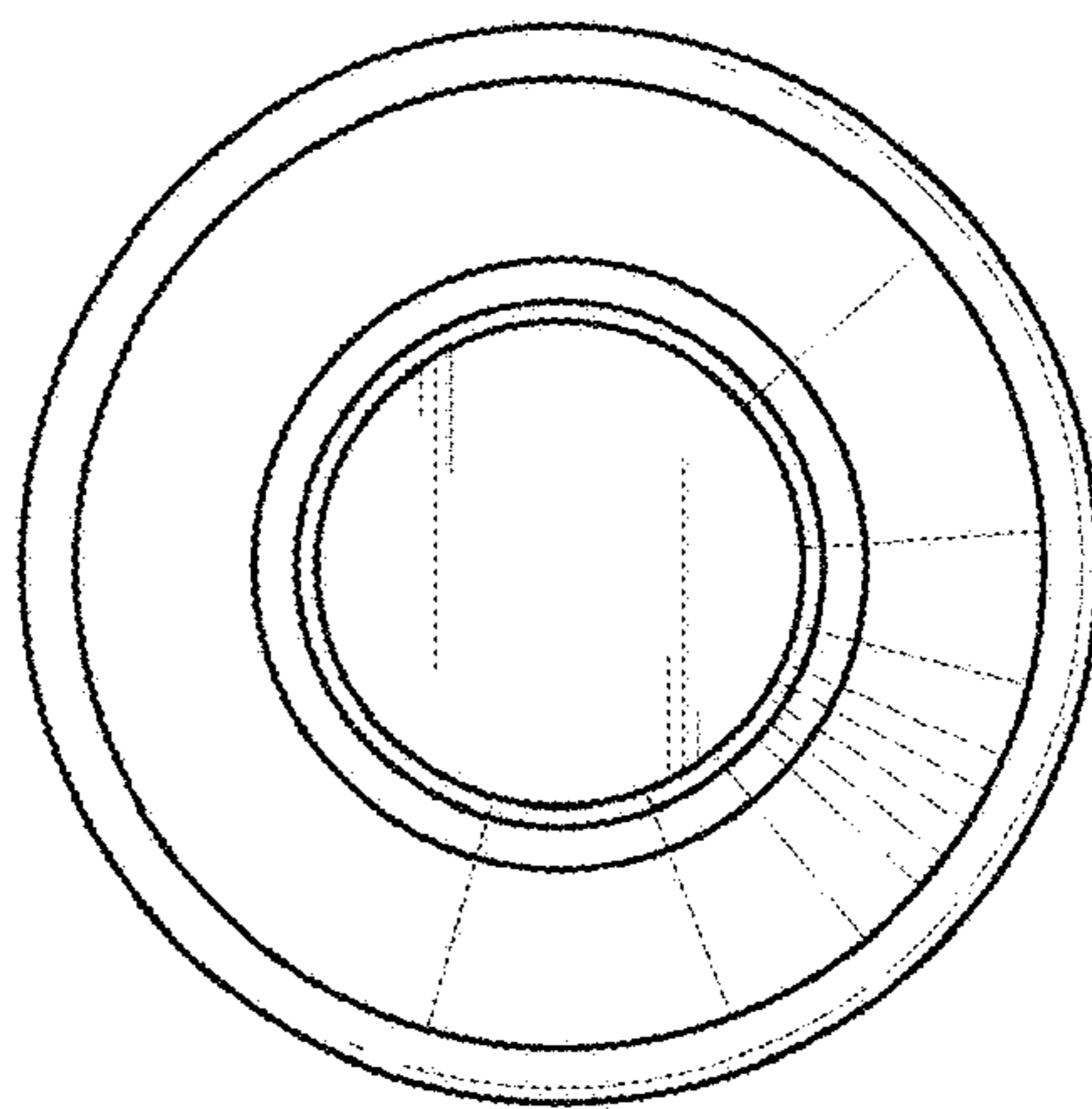

FIG. 7