



US00D863956S

(12) **United States Design Patent** (10) **Patent No.:** **US D863,956 S**  
**Riffe et al.** (45) **Date of Patent:** **\*\* Oct. 22, 2019**

(54) **OVER THE COUNTER MEDICINAL CONTAINER WITH SURFACE ORNAMENTATION**

(71) Applicant: **The Procter & Gamble Company**, Cincinnati, OH (US)

(72) Inventors: **Mary Carol Riffe**, Cincinnati, OH (US); **Amy Marie Kletz**, Cincinnati, OH (US); **Matt S. Moses**, Cincinnati, OH (US)

(73) Assignee: **The Procter & Gamble Company**, Cincinnati, OH (US)

(\*\*) Term: **15 Years**

(21) Appl. No.: **29/661,842**

(22) Filed: **Aug. 31, 2018**

(51) **LOC (12) Cl.** ..... **09-07**

(52) **U.S. Cl.**  
USPC ..... **D9/434; D9/516**

(58) **Field of Classification Search**  
USPC ..... **D3/270, 271.1-271.4; D7/510, 514-520, D7/599, 604, 613, 619.2, 623, 628;**  
(Continued)

(56) **References Cited**

**U.S. PATENT DOCUMENTS**

D587,111 S \* 2/2009 Seol ..... D9/432  
D599,201 S \* 9/2009 Seol ..... D9/432  
(Continued)

**OTHER PUBLICATIONS**

U.S. Appl. No. 29/661,841, filed Aug. 31, 2008, Riffe et al.  
(Continued)

*Primary Examiner* — Sandra L Morris  
(74) *Attorney, Agent, or Firm* — Amanda Herman Berghauer

(57) **CLAIM**

The ornamental design for an over the counter medicinal container with surface ornamentation, as shown and described.

**DESCRIPTION**

The present application file contains at least one drawing executed in color. Copies of this patent or patent application publication with color drawing(s) will be provided by the Office upon request and payment of the necessary fee.

FIG. 1 is a perspective view of an over the counter medicinal container with surface ornamentation embodying our new design;

FIG. 2 is a front view thereof;

FIG. 3 is a left side view thereof;

FIG. 4 is a rear view thereof;

FIG. 5 is a right side view thereof;

FIG. 6 is a top view thereof;

FIG. 7 is a bottom view thereof;

FIG. 8 is a perspective view of a second embodiment of an over the counter medicinal container with surface ornamentation embodying our new design;

FIG. 9 is a front view thereof;

FIG. 10 is a left side view thereof;

FIG. 11 is a rear view thereof;

FIG. 12 is a right side view thereof;

FIG. 13 is a top view thereof;

FIG. 14 is a bottom view thereof;

FIG. 15 is a perspective view of a third embodiment of an over the counter medicinal container with surface ornamentation embodying our new design;

FIG. 16 is a front view thereof;

FIG. 17 is a left side view thereof;

FIG. 18 is a rear view thereof;

FIG. 19 is a right side view thereof;

FIG. 20 is a top view thereof; and,

FIG. 21 is a bottom view thereof.

The evenly broken lines are shown for the purpose of illustrating parts of the article that form no part of the claim. The dot-dash lines represent the boundaries of the claim and form no part thereof.

**1 Claim, 12 Drawing Sheets**  
**(9 of 12 Drawing Sheet(s) Filed in Color)**

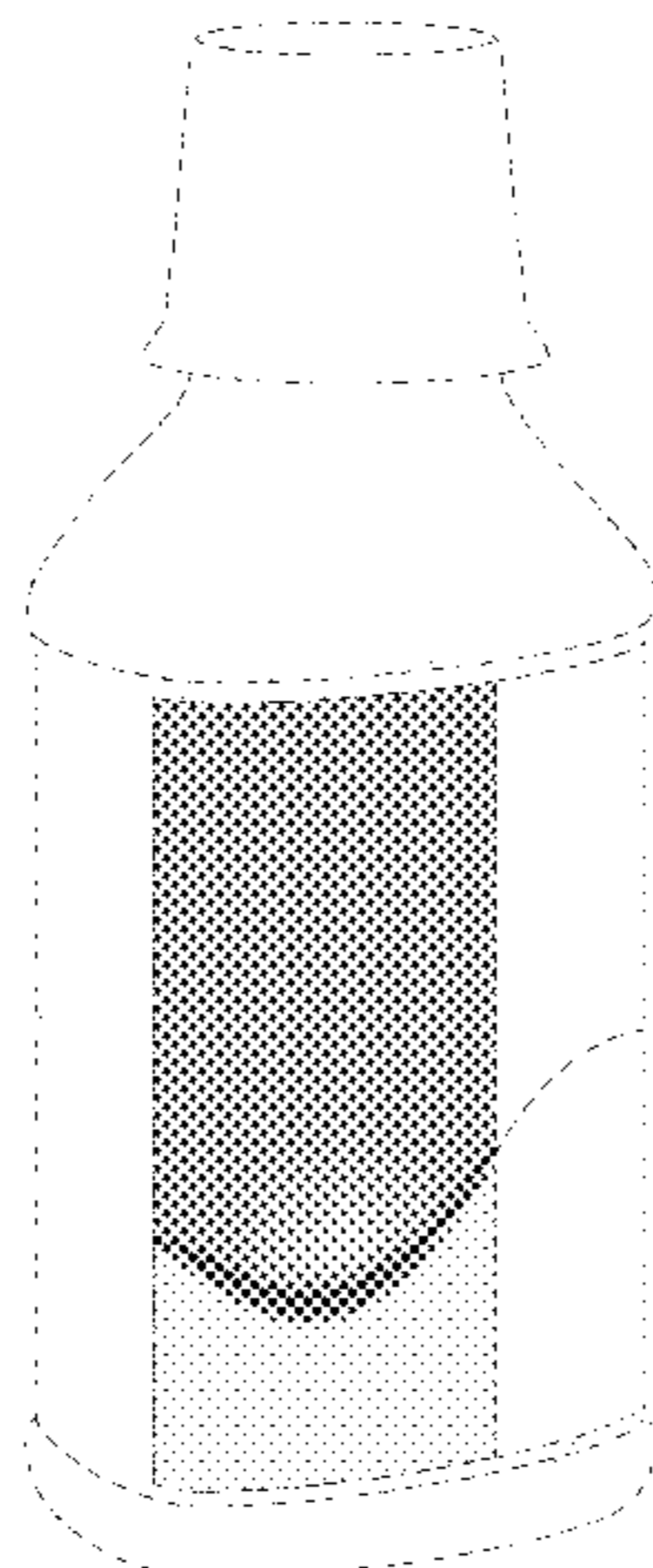

(58) **Field of Classification Search**

USPC ..... D9/600, 414–434, 500–504; 206/457,  
 206/459.5, 527; 215/381–384, 400;  
 D20/23–25, 27–28  
 CPC ..... B65D 5/42; B65D 5/4258; B65D 81/36;  
 B65D 81/365; B65D 81/366; B65D  
 81/368; B65D 2203/00; B65D 2203/02;  
 B65D 37/00; B65D 85/00; B65D 75/22;  
 B65D 75/366; A63H 33/16; B32D 73/16;  
 B32D 73/162; B32D 73/164

See application file for complete search history.

(56) **References Cited**

U.S. PATENT DOCUMENTS

D600,548 S \* 9/2009 Seol ..... D9/432  
 D608,636 S \* 1/2010 Seol ..... D9/432  
 D638,703 S \* 5/2011 Sovonick ..... D9/434  
 D647,796 S \* 11/2011 Sovonick ..... D9/434  
 D647,797 S \* 11/2011 Sovonick ..... D9/434  
 D649,044 S \* 11/2011 Sovonick ..... D9/434

D649,877 S \* 12/2011 Sovonick ..... D9/434  
 D650,273 S \* 12/2011 Tekulve ..... D9/432  
 D655,155 S \* 3/2012 Tekulve ..... D9/432  
 D655,156 S \* 3/2012 Schrimpf ..... D9/432  
 D655,602 S \* 3/2012 Hablutzel ..... D9/434  
 D677,580 S \* 3/2013 Powers ..... D9/434  
 D686,066 S \* 7/2013 Macaulay ..... D9/434  
 D686,067 S \* 7/2013 Macaulay ..... D9/434  
 D706,630 S \* 6/2014 Merchant ..... D9/434  
 D707,122 S \* 6/2014 Merchant ..... D9/434  
 D711,737 S \* 8/2014 Hara ..... D9/432  
 D712,736 S \* 9/2014 Hara ..... D9/432  
 D764,290 S \* 8/2016 Alexander ..... D9/434  
 D783,397 S \* 4/2017 Riffe ..... D9/434  
 D822,477 S \* 7/2018 Ishizawa ..... D9/414  
 D829,546 S \* 10/2018 Gagliardo ..... D9/434

OTHER PUBLICATIONS

U.S. Appl. No. 29/661,843, filed Aug. 31, 2008, Riffe et al.  
 U.S. Appl. No. 29/661,844, filed Aug. 31, 2008, Riffe et al.  
 U.S. Appl. No. 29/661,845, filed Aug. 31, 2008, Riffe et al.

\* cited by examiner

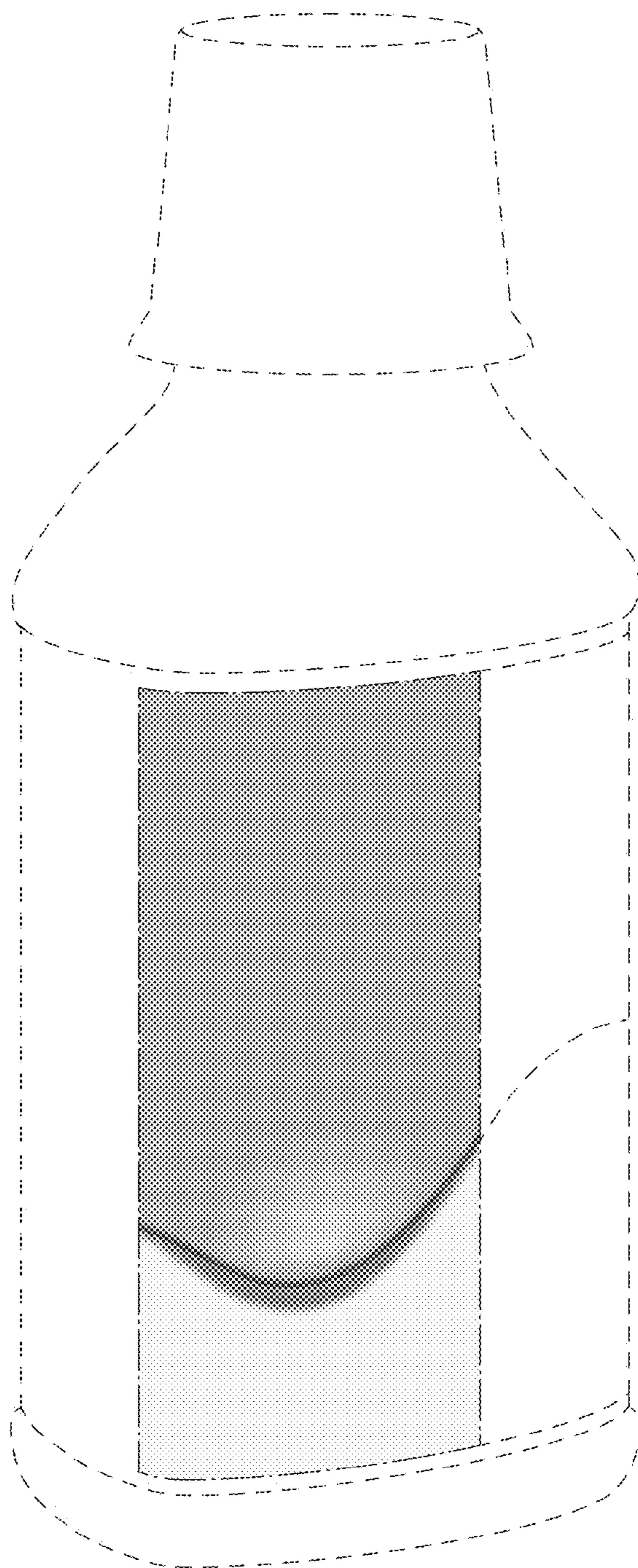

FIG. 1



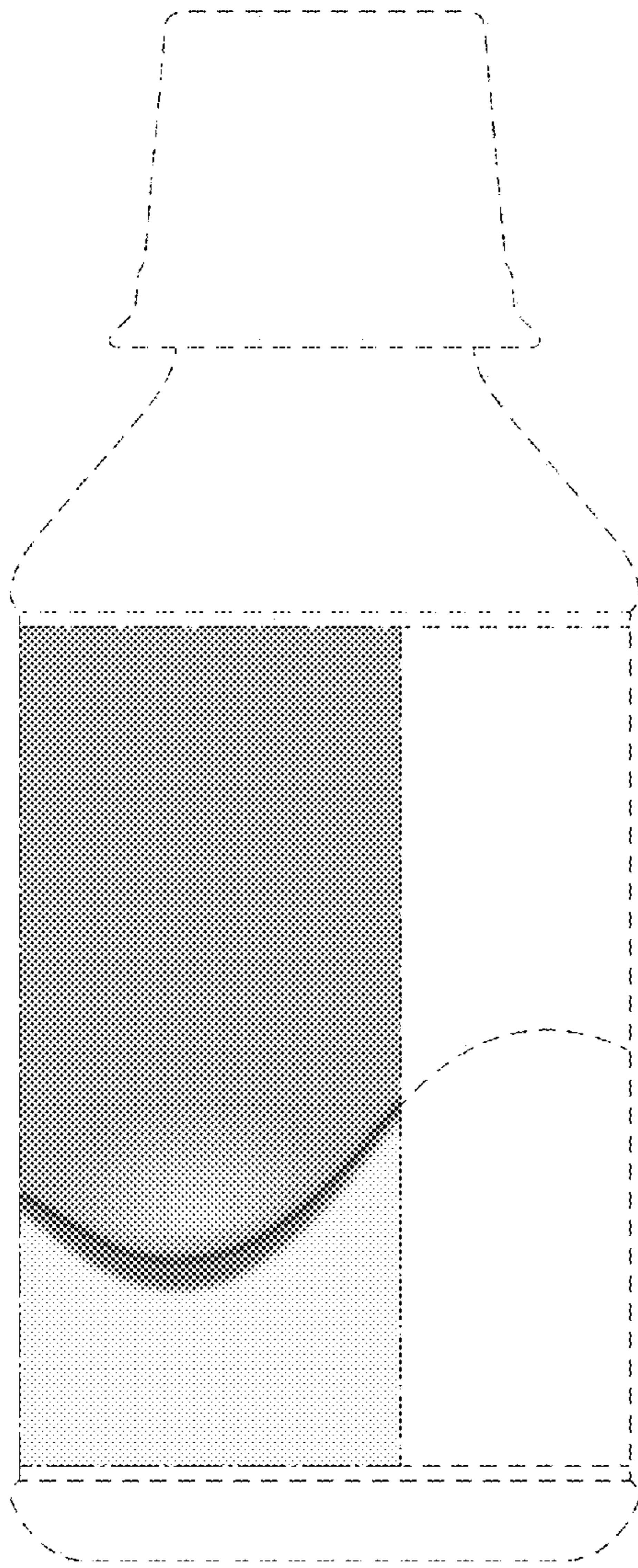

FIG. 2

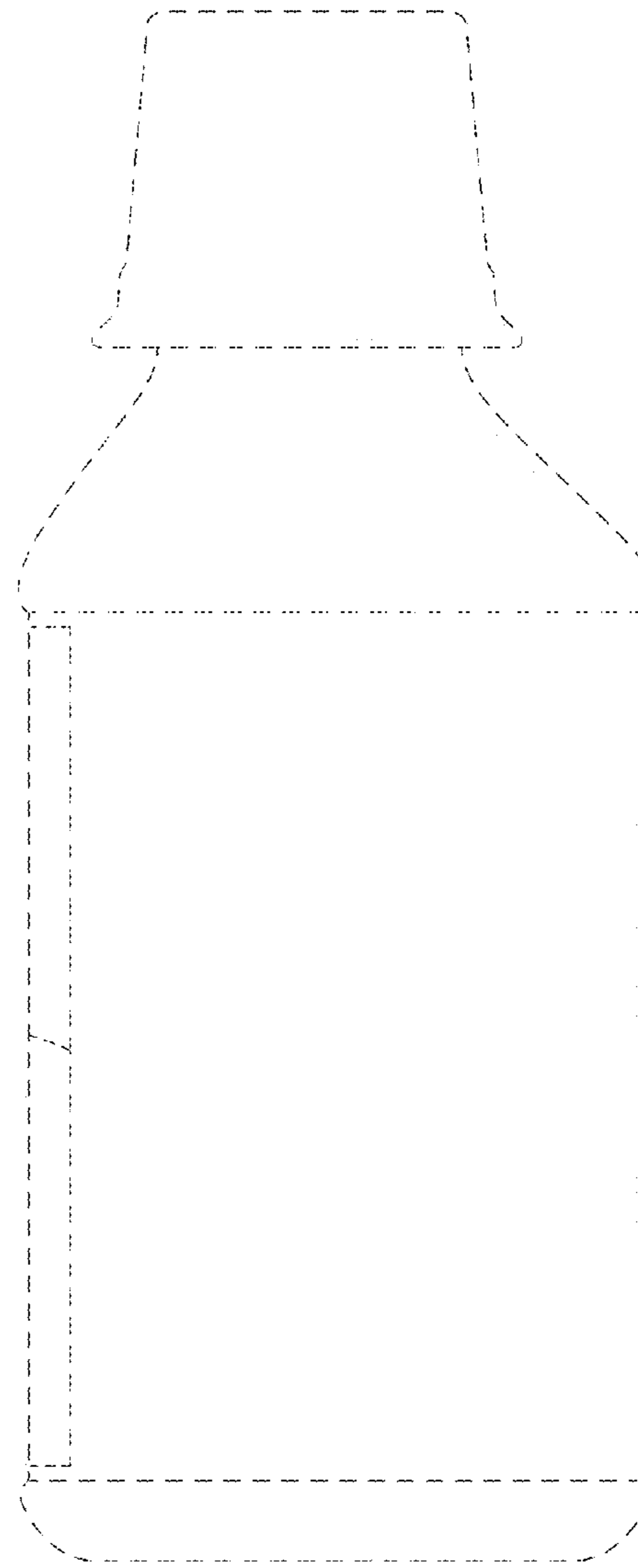

FIG. 3

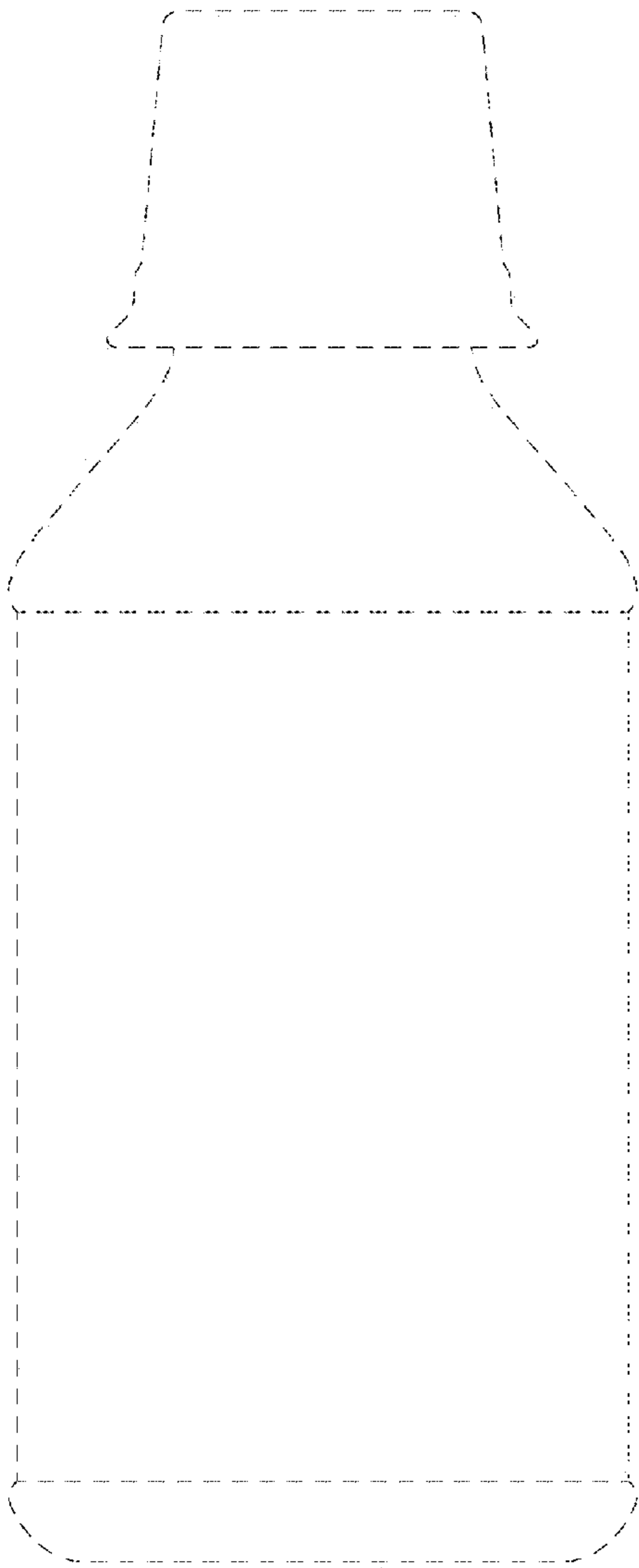

FIG. 4

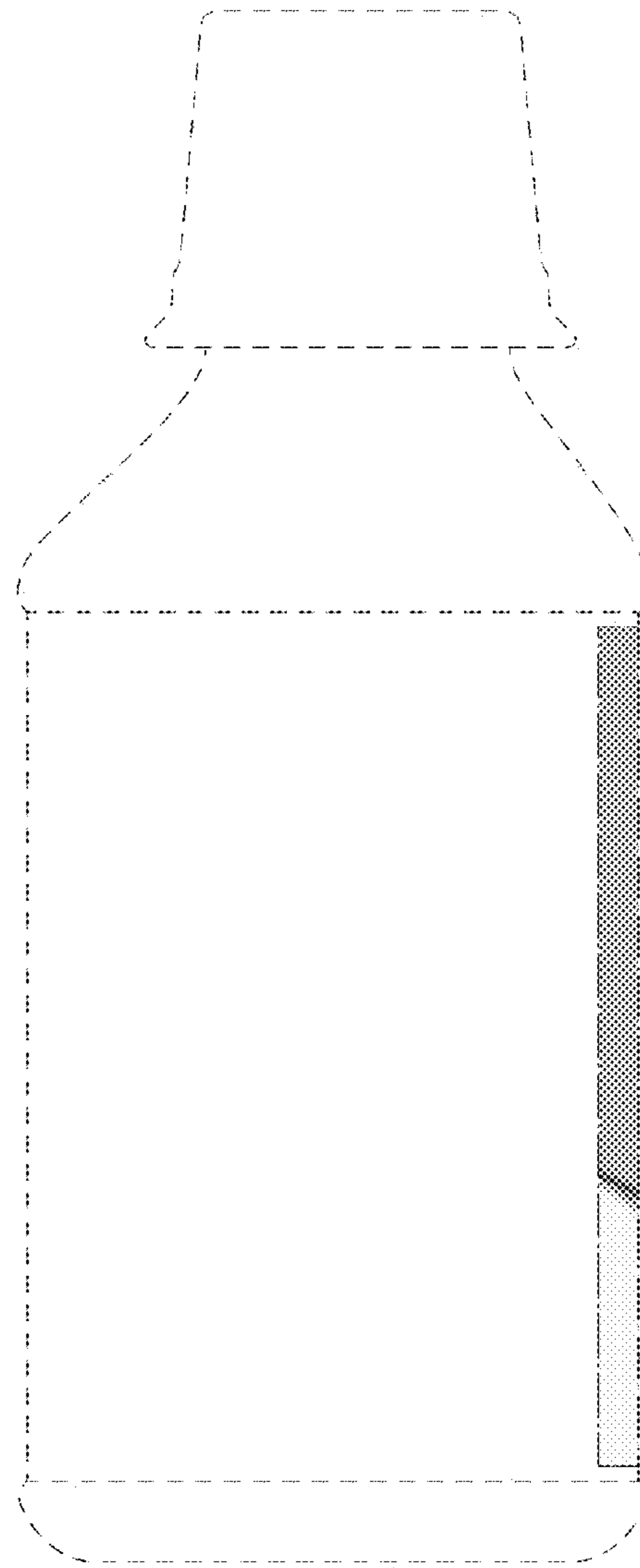

FIG. 5

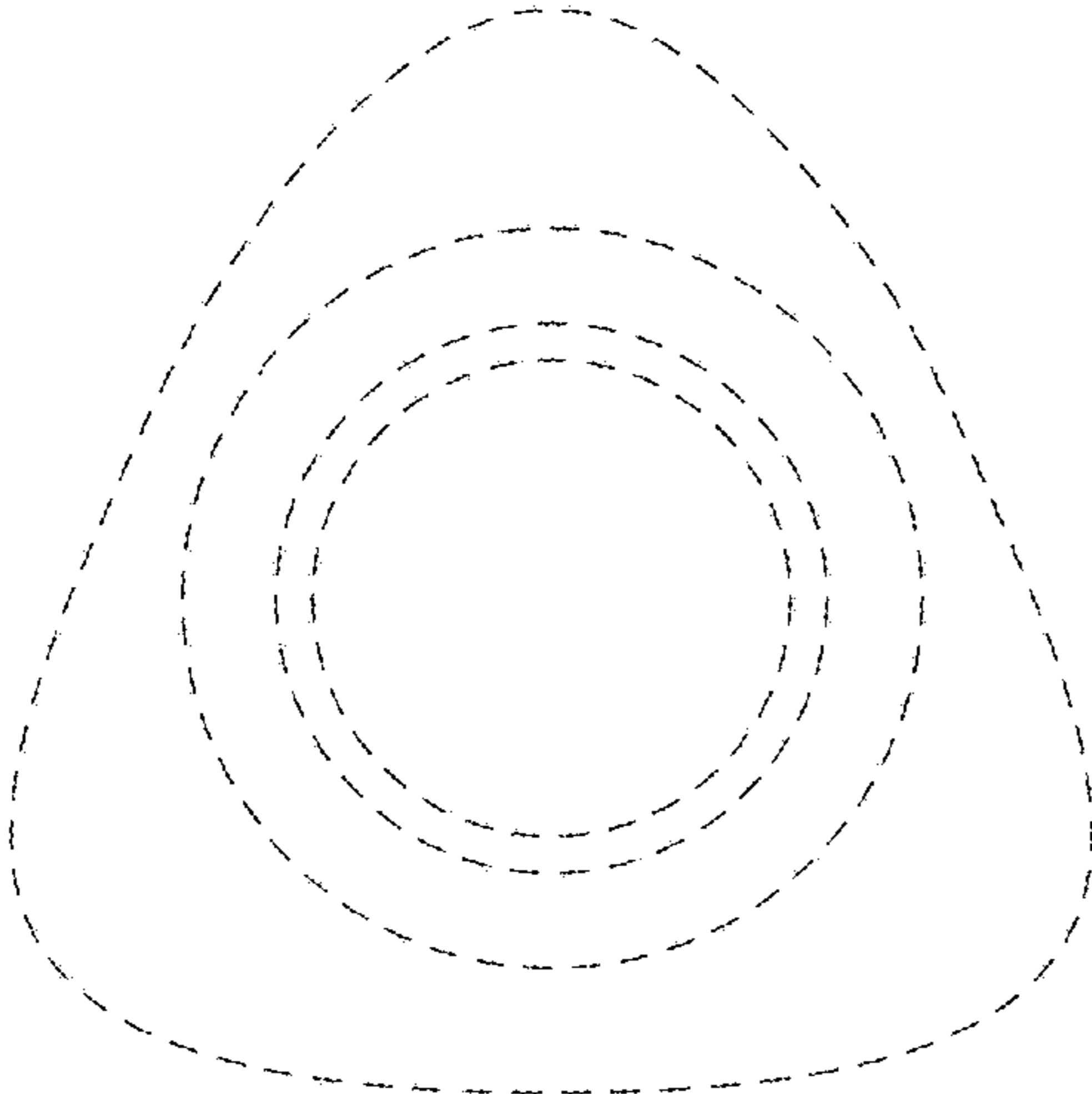

FIG. 6

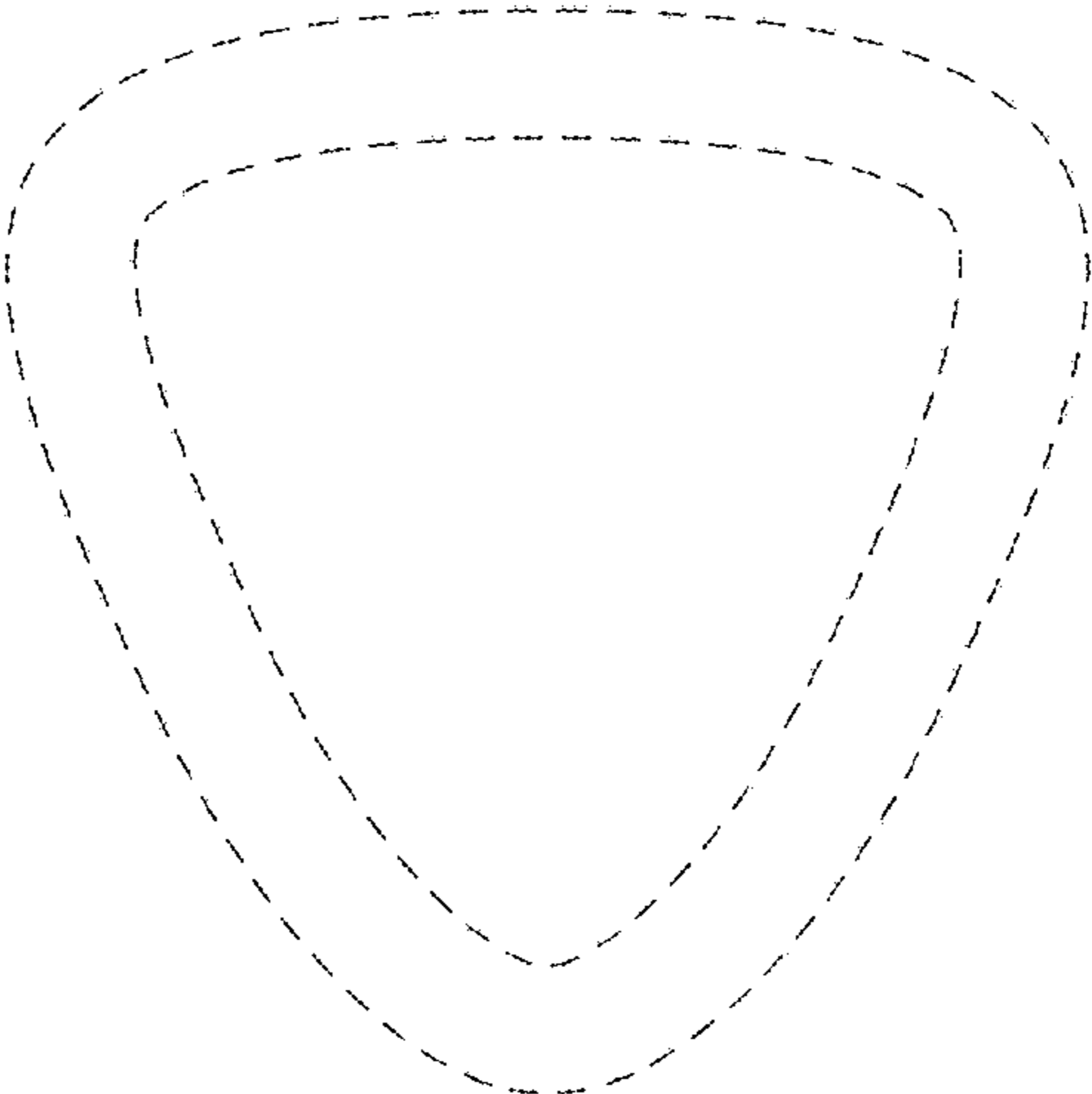

FIG. 7

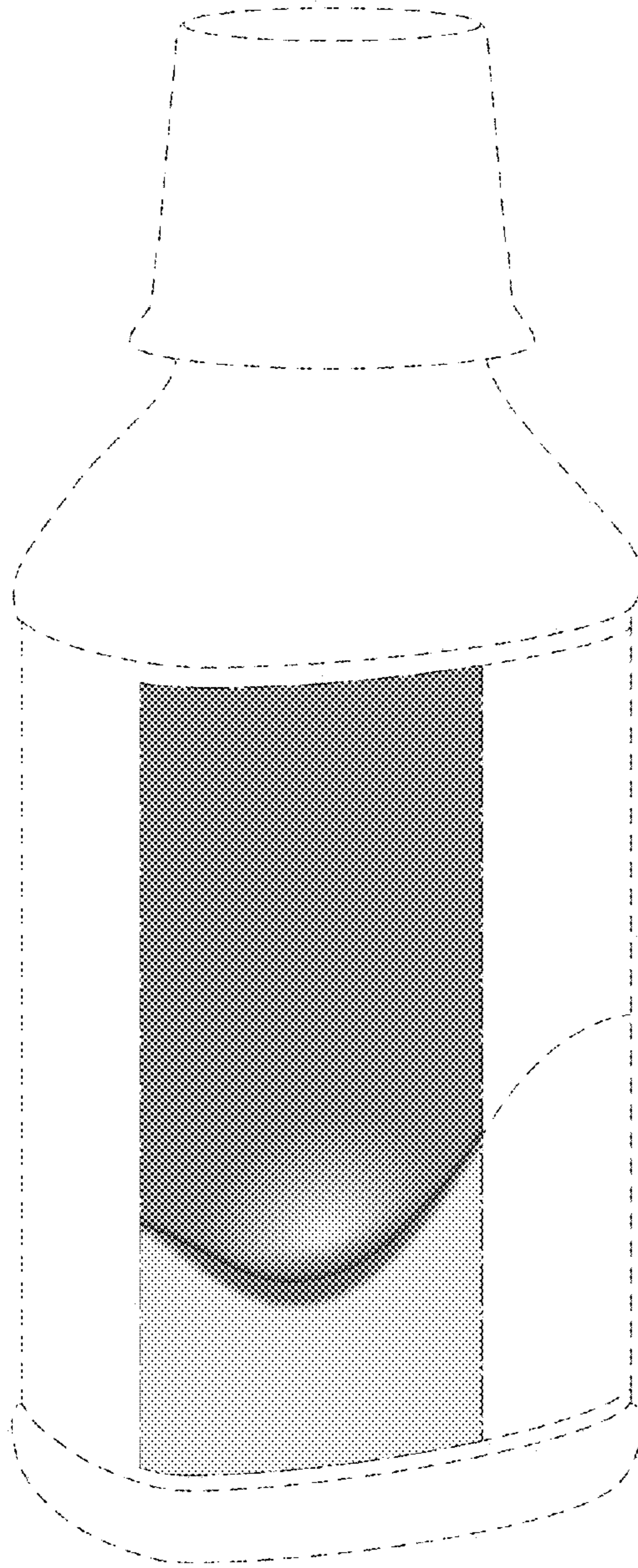

FIG. 8

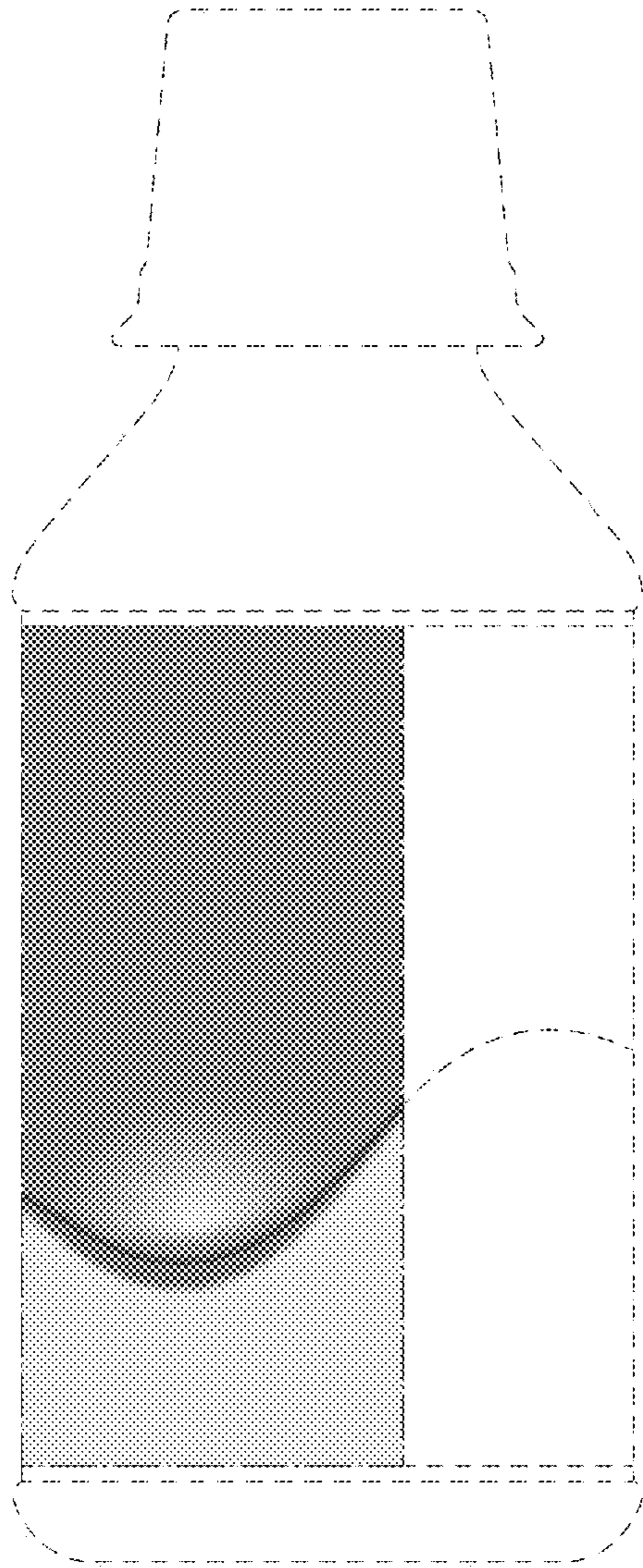

FIG. 9

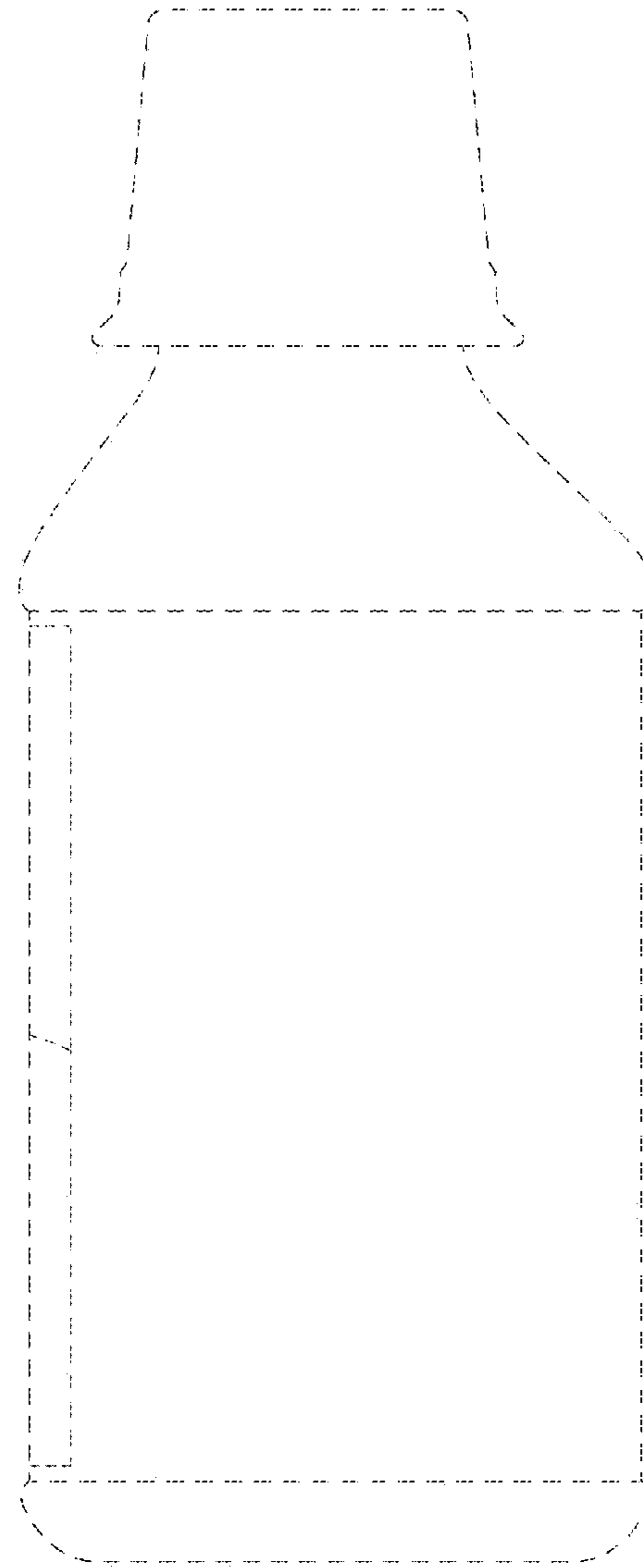

FIG. 10



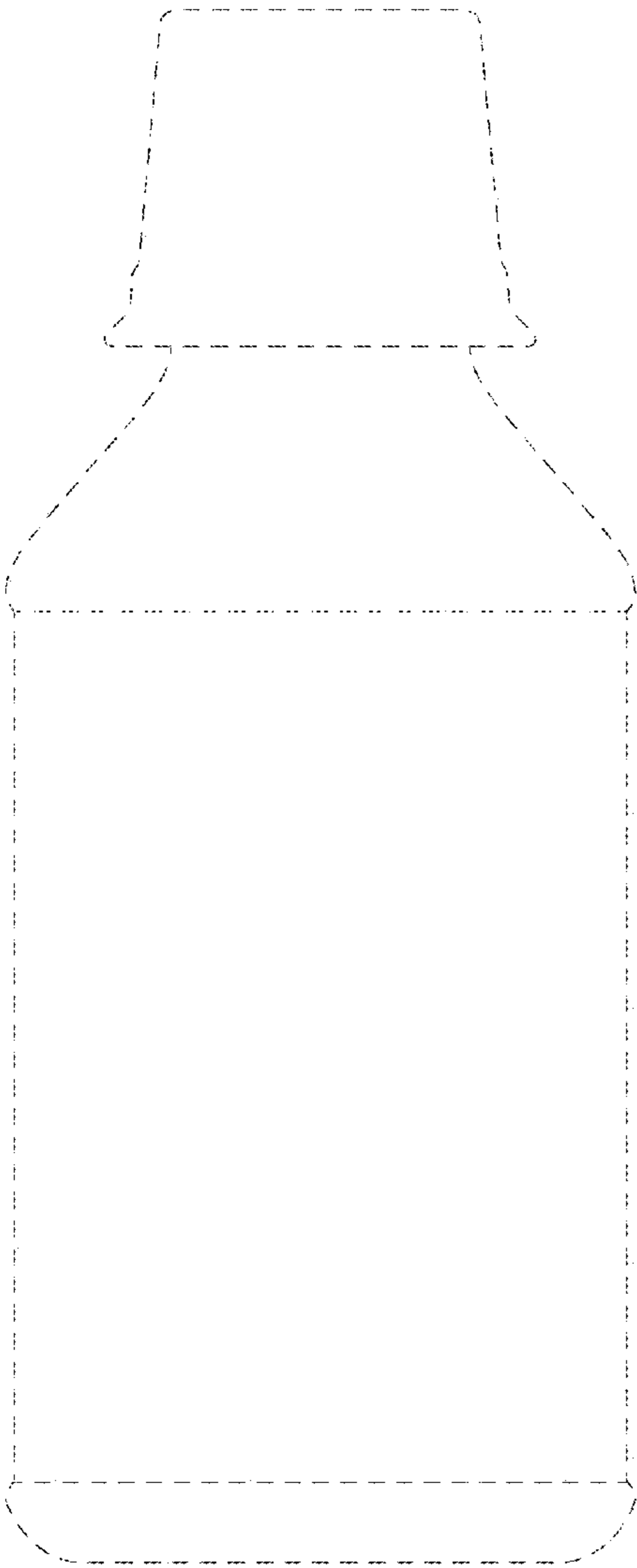

FIG. 11

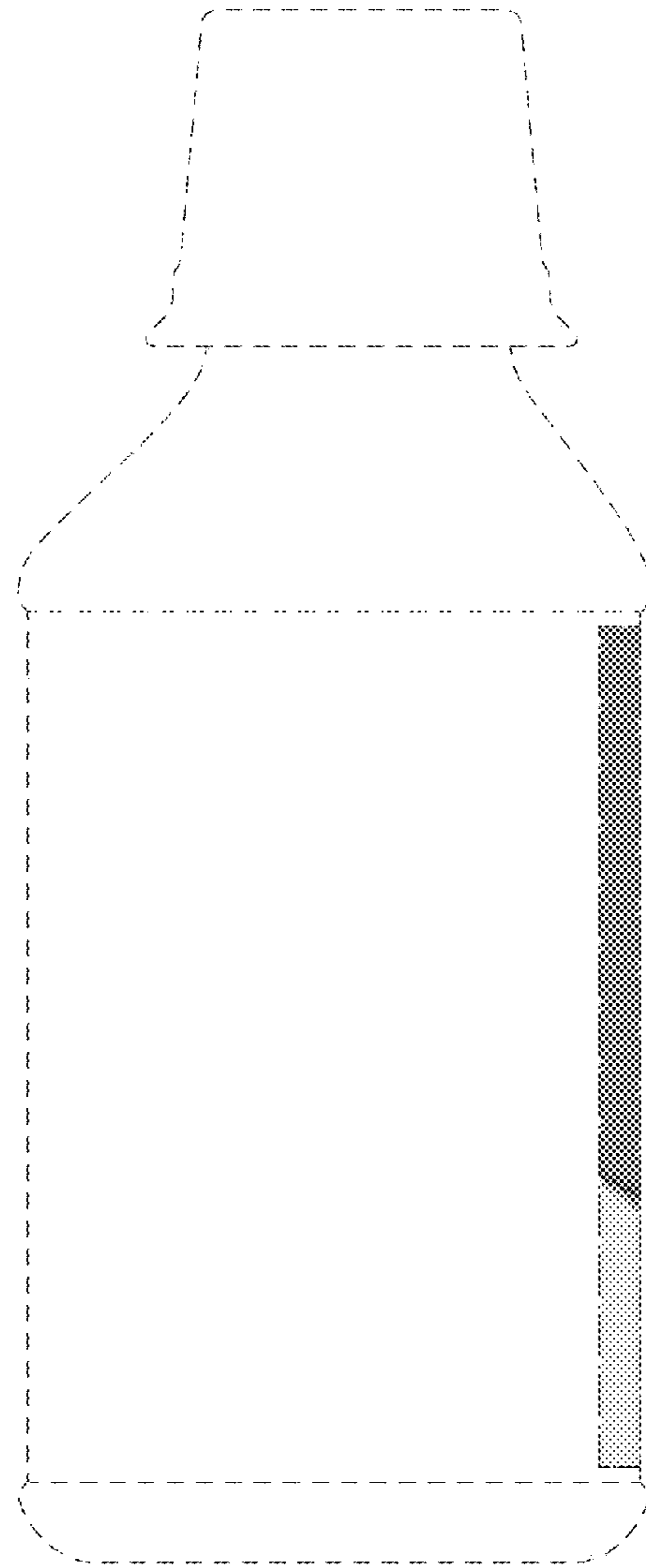

FIG. 12

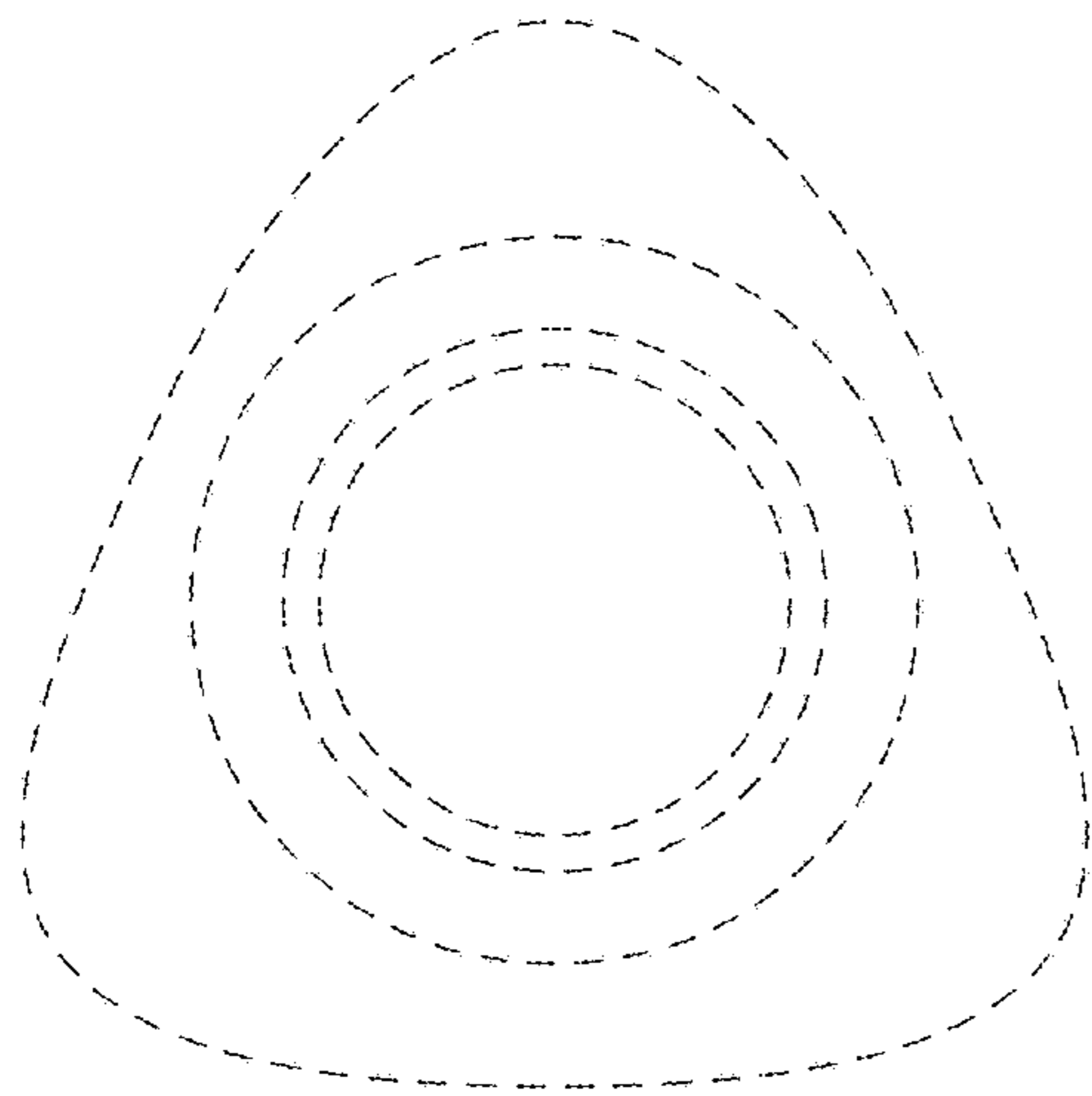

FIG. 13

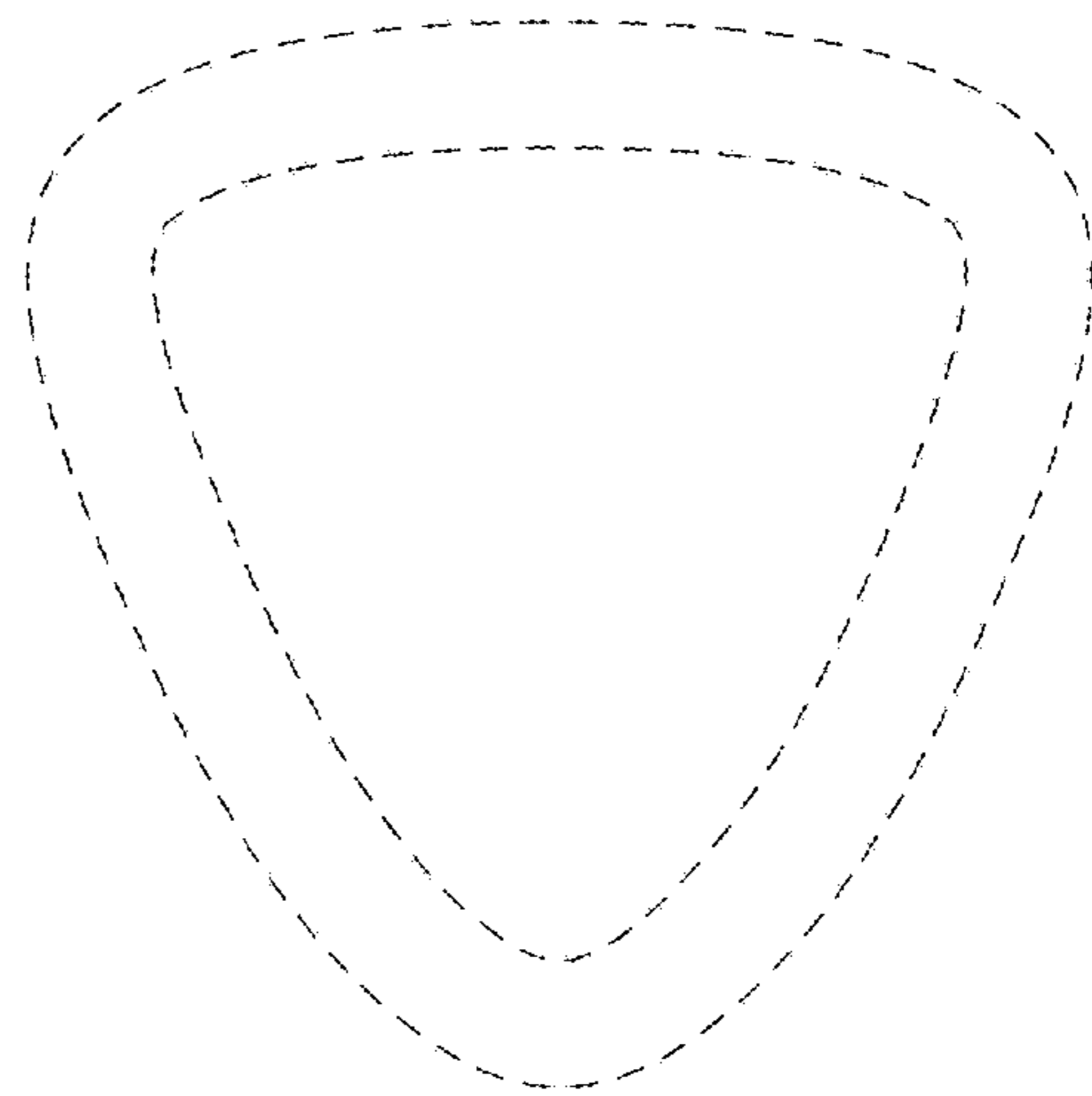

FIG. 14

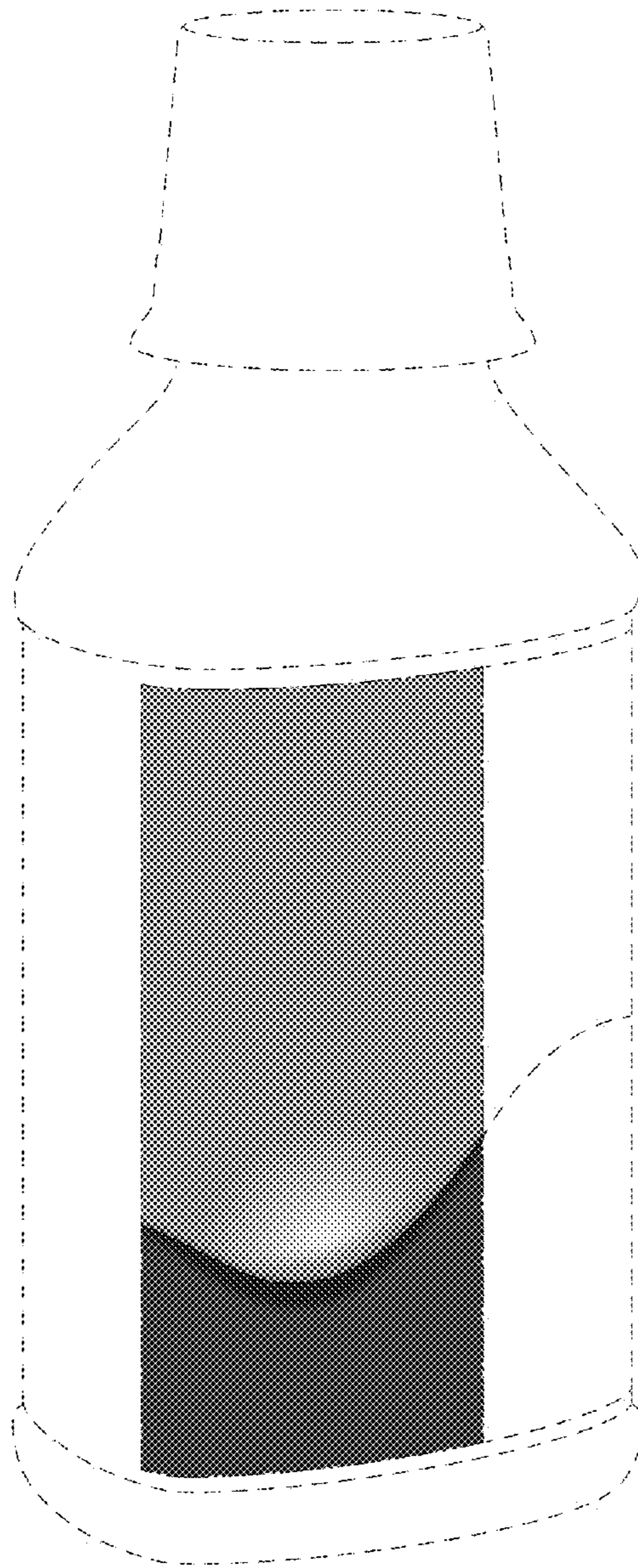

FIG. 15

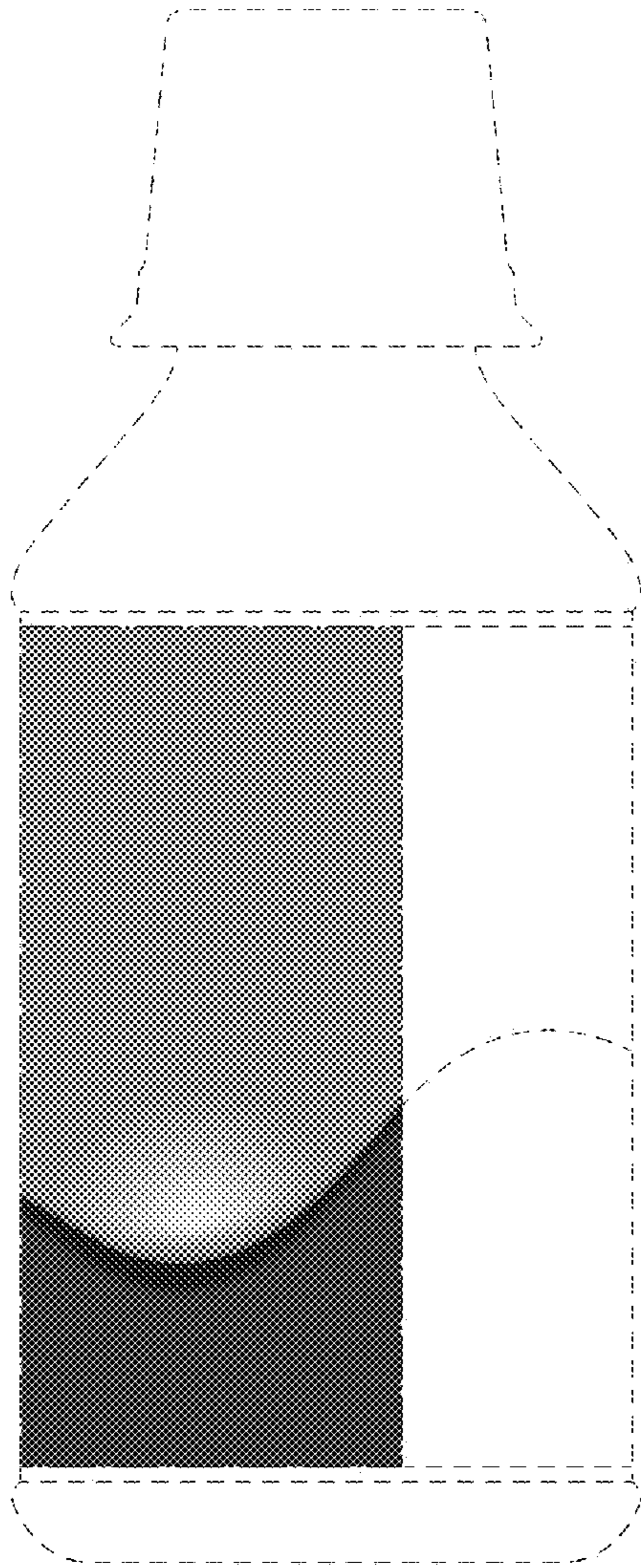

FIG. 16

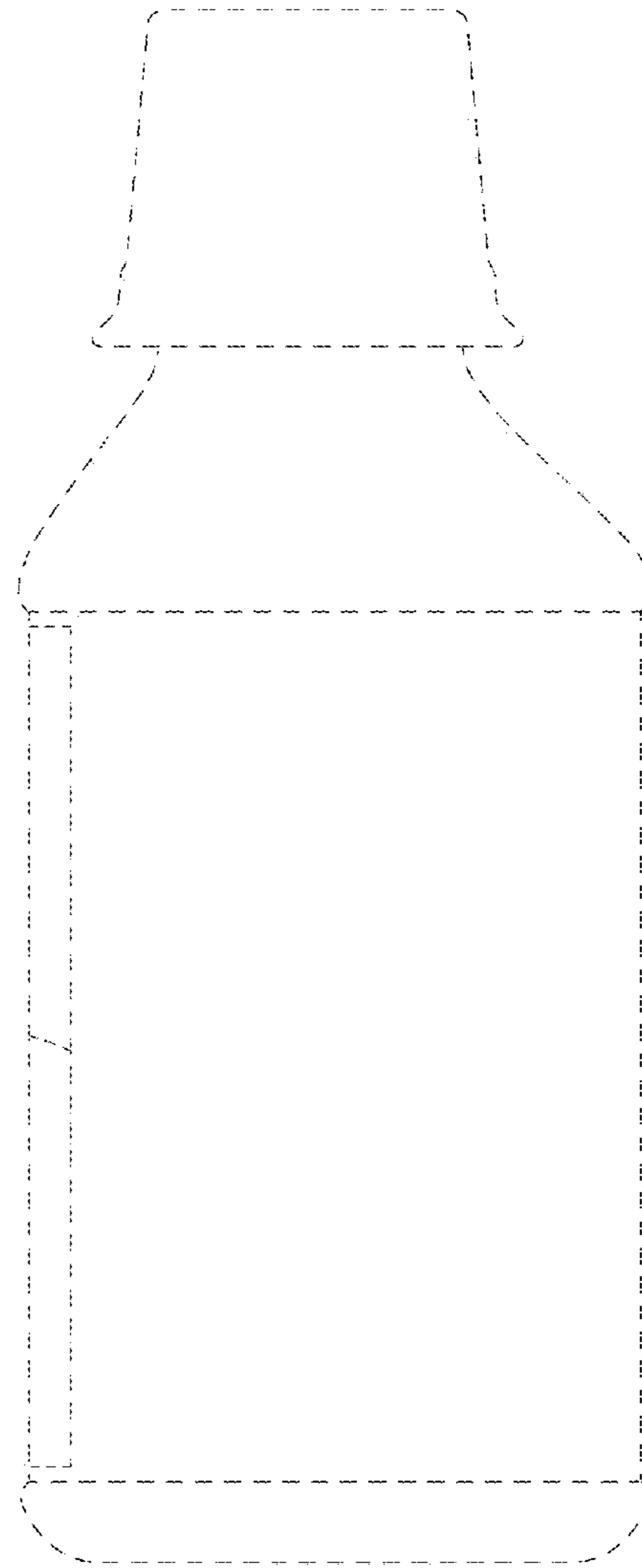

FIG. 17

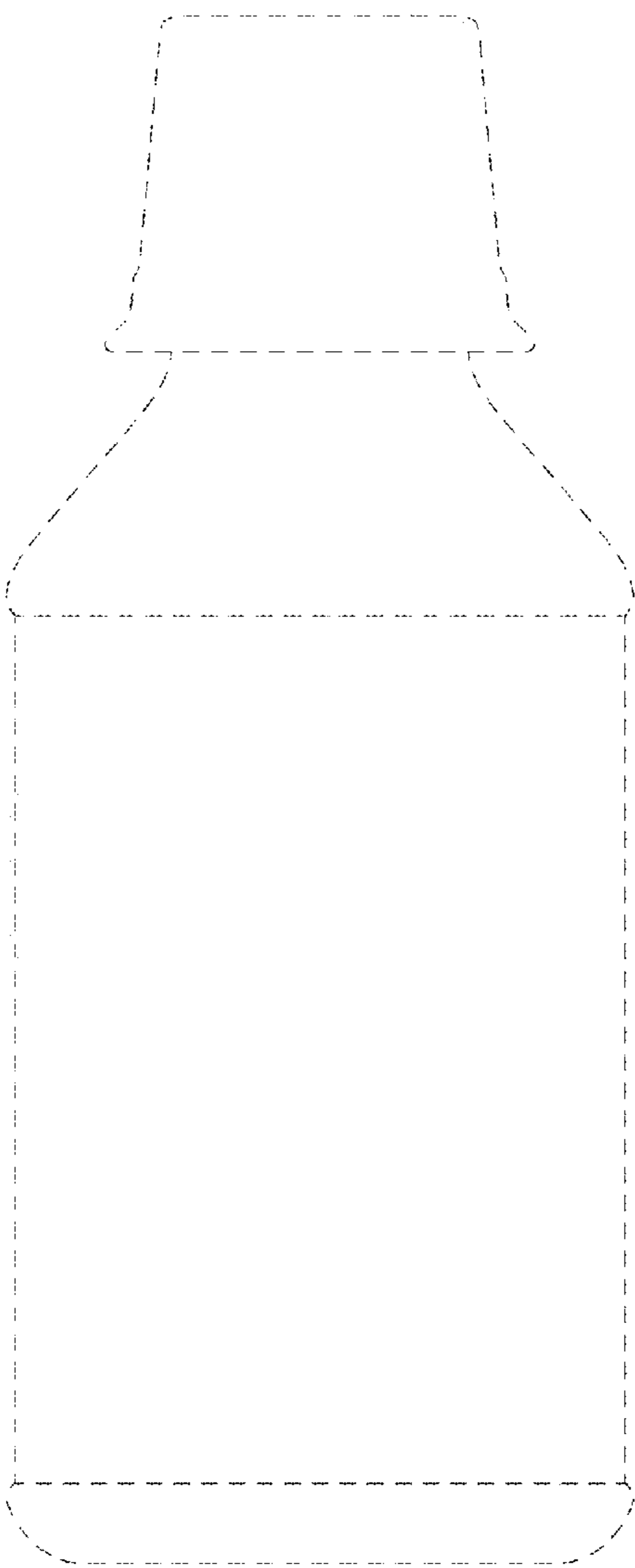

FIG. 18

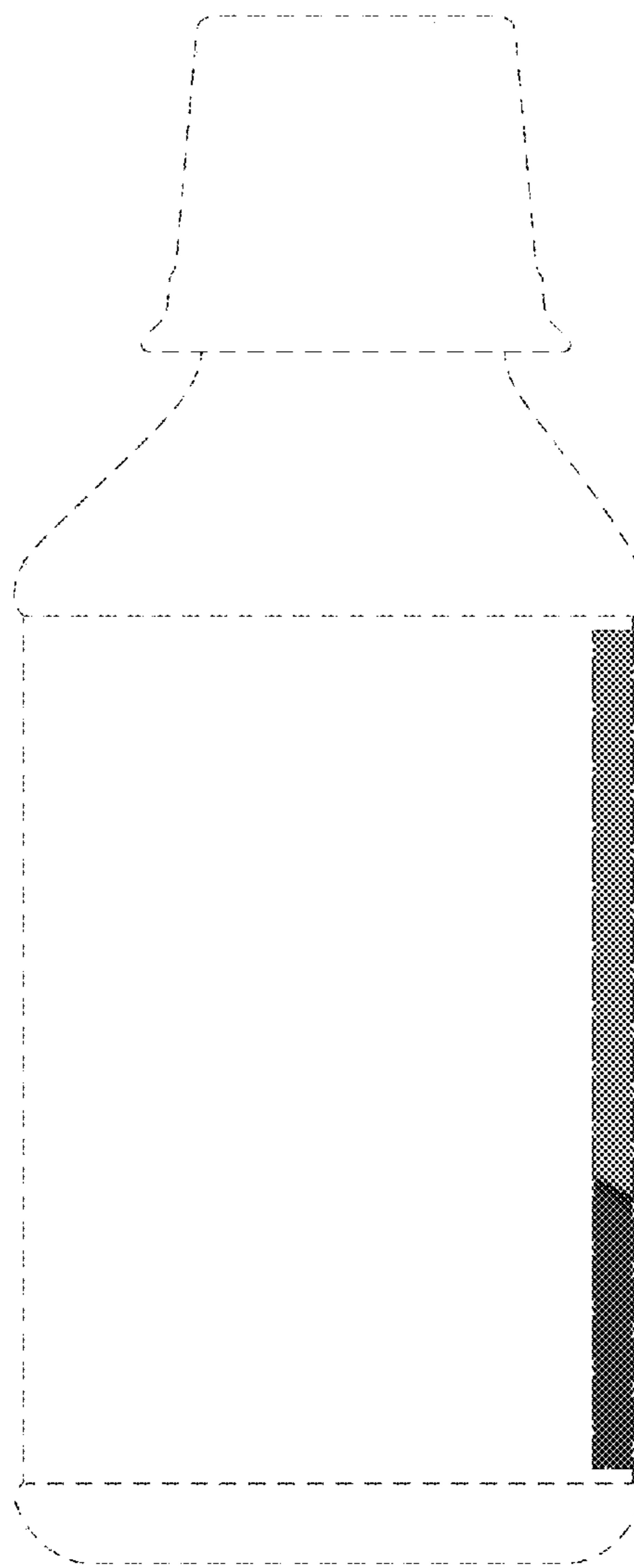

FIG. 19



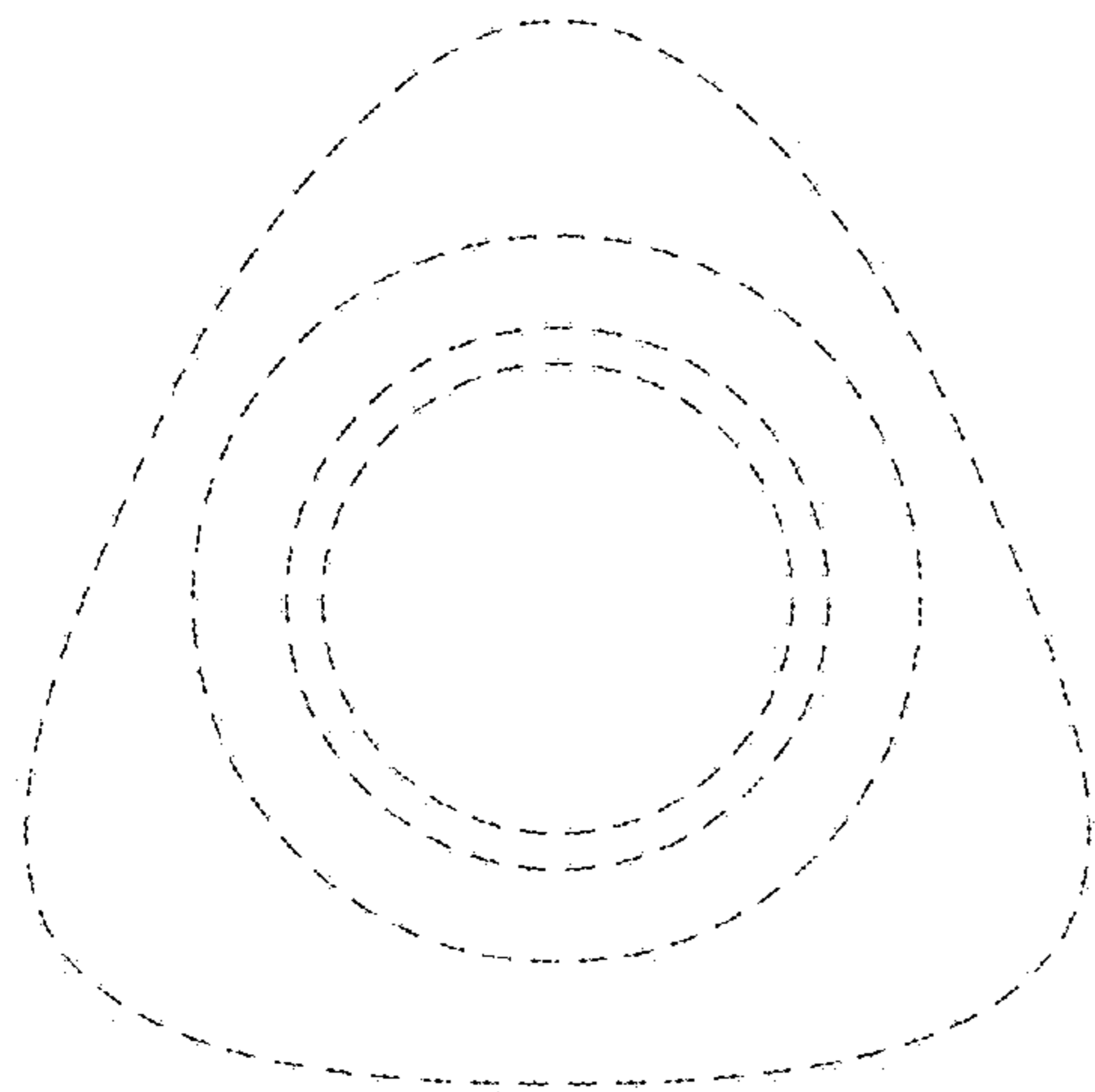

FIG. 20

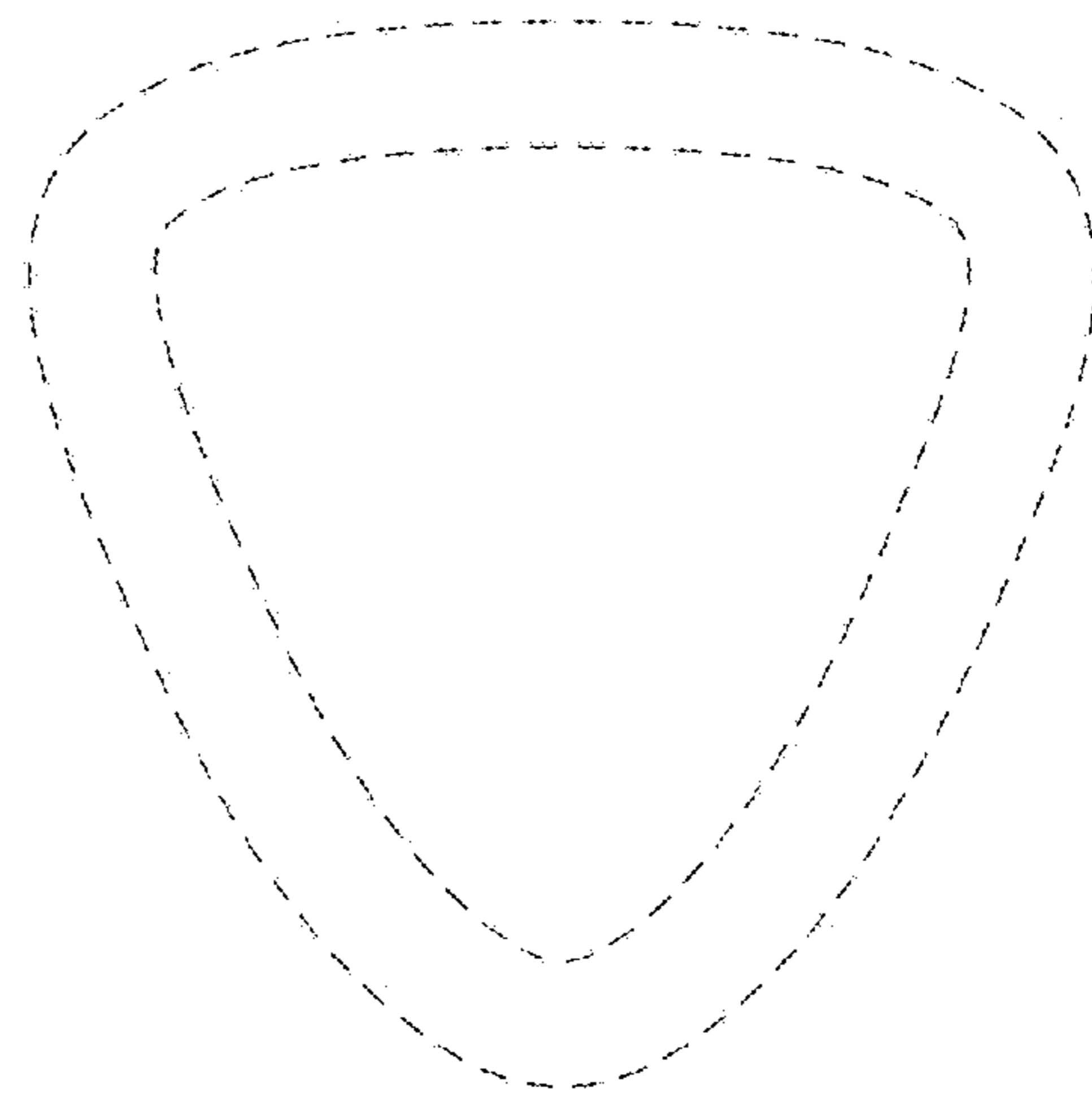

FIG. 21