

US00D863919S

(12) **United States Design Patent** (10) **Patent No.:** **US D863,919 S**
Spatz et al. (45) **Date of Patent:** **** Oct. 22, 2019**

- (54) **DIRECTIONAL DRILLING ASSEMBLY**
- (71) Applicants: **Edward C. Spatz**, San Marcos, TX (US); **Michael R. Reese**, Houston, TX (US); **David P. Miess**, Spring, TX (US); **Gregory Prevost**, Spring, TX (US)
- (72) Inventors: **Edward C. Spatz**, San Marcos, TX (US); **Michael R. Reese**, Houston, TX (US); **David P. Miess**, Spring, TX (US); **Gregory Prevost**, Spring, TX (US)

4,485,879 A	12/1984	Kamp et al.	
4,729,438 A	3/1988	Walker et al.	
4,848,490 A	7/1989	Anderson	
6,073,707 A	6/2000	Noe et al.	
6,722,453 B1	4/2004	Crooks	
8,162,081 B2	4/2012	Ballard et al.	
D710,174 S *	8/2014	Moss	D8/70
D710,175 S *	8/2014	Moss	D8/70
D710,176 S *	8/2014	Santamarina	D8/70
D713,706 S *	9/2014	Jing	D15/140
D717,626 S *	11/2014	Dickrede	D8/70
D731,277 S *	6/2015	Manwaring	D8/70

(Continued)

OTHER PUBLICATIONS

- (73) Assignee: **XR Lateral, LLC**, Houston, TX (US)

Spatz, et al.; U.S. Appl. No. 29/616,776, filed Sep. 8, 2017 [3 pages].

- (**) Term: **15 Years**

(Continued)

- (21) Appl. No.: **29/616,773**

Primary Examiner — Darlington Ly

- (22) Filed: **Sep. 8, 2017**

(74) *Attorney, Agent, or Firm* — Michael S. McCoy; Amatong McCoy LLC

- (51) **LOC (12) Cl.** **08-05**

- (52) **U.S. Cl.** **D8/70**
USPC

- (58) **Field of Classification Search**
USPC D8/70, 82, 85-87, 105; D15/139
CPC B25B 13/06; B25B 13/5091; B25B 15/00;
B25B 15/001; B25B 15/002; B25B 15/004;
B25B 15/005; B25B 15/008; B25B 15/02;
B25B 15/04; B25B 17/00; B25B 21/007;
B25B 23/00; B25B 23/0035; B25B 23/005;
B25B 23/12; B25B 23/1405; B25B 27/18; B25B 31/12;
B25B 51/08; B25B 51/108; B25B 2251/66; B23P 15/00

See application file for complete search history.

- (56) **References Cited**

U.S. PATENT DOCUMENTS

2,919,897 A	1/1960	Sims
3,561,549 A	2/1971	Garrison et al.
4,465,147 A	8/1984	Feenstra et al.

(57) **CLAIM**

The ornamental design for a directional drilling assembly, as shown and described.

DESCRIPTION

FIG. 1 is a front elevation view of a directional drilling assembly showing our new design;
 FIG. 2 is a left side elevation view thereof;
 FIG. 3 is a right side elevation view thereof;
 FIG. 4 is a rear elevation view thereof;
 FIG. 5 is a cross-sectional view thereof taken along line 5-5 in FIG. 1; and,
 FIG. 6 is a cross-sectional view thereof taken along line 6-6 in FIG. 1.

The broken lines in the drawings illustrate portions of the directional drilling assembly that form no part of the claimed design.

1 Claim, 1 Drawing Sheet

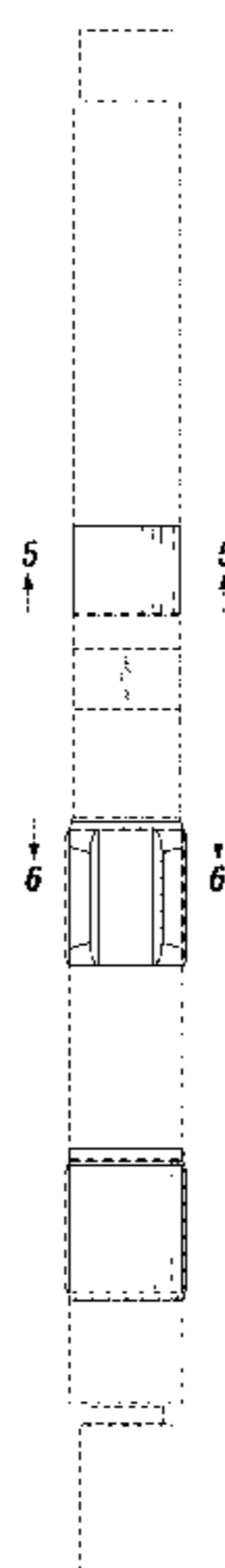

(56)

References Cited

U.S. PATENT DOCUMENTS

D732,364	S *	6/2015	Rinaldis	D8/70
9,163,460	B2	10/2015	Isenhour et al.		
D786,645	S *	5/2017	Svendsen	D15/139
D793,831	S *	8/2017	Russell	D8/70
D793,832	S *	8/2017	Russell	D8/70
D793,833	S *	8/2017	Russell	D8/70
D813,003	S *	3/2018	Chang	D8/70
9,963,938	B2	5/2018	Foote et al.		

OTHER PUBLICATIONS

Wenzel Downhole Tools; "Motor Handbook", 4th Edition Ver. 1.0a; Issue Date, Dec. 23, 2013 [135 pages].
Baker Hughes Incorporated; "Navi-Drill Motor Handbook"; revised Jan. 2017 [206 pages].
Cobra Downhole Motors; "Motor Manual" dated Feb. 2016 [126 pages].
National Oilwell Varco; "Drilling Motors", 2011 [20 pages].

Schlumberger; "Powerpak, Steerable Motor Handbook", 2004 [204 pages].
Spatz, et al.; U.S. Appl. No. 29/616,762, filed Sep. 8, 2017 [3 pages].
Spatz, et al.; U.S. Appl. No. 29/616,766, filed Sep. 8, 2017 [3 pages].
Spatz, et al.; U.S. Appl. No. 29/616,768, filed Sep. 8, 2017 [3 pages].
Spatz, et al.; U.S. Appl. No. 29/616,772, filed Sep. 8, 2017 [3 pages].
Spatz, et al.; U.S. Appl. No. 29/616,773, filed Sep. 8, 2017 [3 pages].
Tomahawk Downhole, L.L.C.; "The Cutting Edge in Mud Motors and Mud Motor Components, Motor Handbook" Rev. 7, 2011 [79 pages].
Wenzel Downhole Tools; "Motor Handbook", 4th Edition Ver. 1.0a; Issue Date, Dec. 23, 2013 [Part 1: 64 pages].
Wenzel Downhole Tools; "Motor Handbook", 4th Edition Ver. 1.0a; Issue Date, Dec. 23, 2013 [Part 2: 65 pages].

* cited by examiner

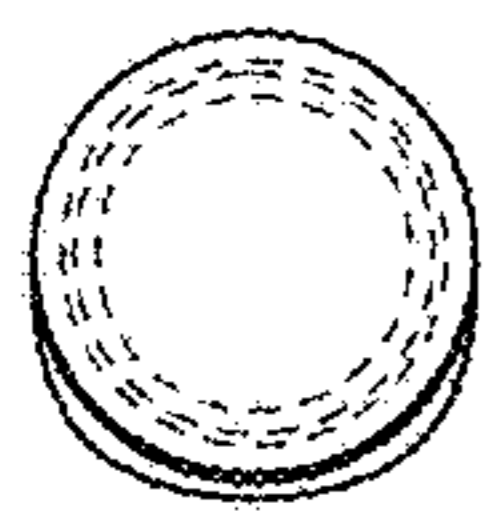

FIG. 5

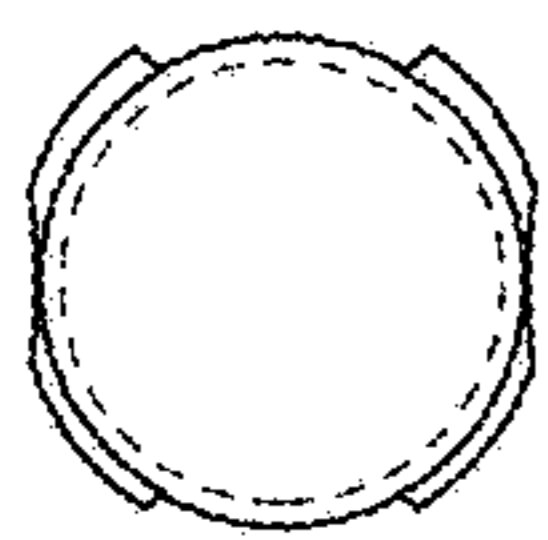

FIG. 6

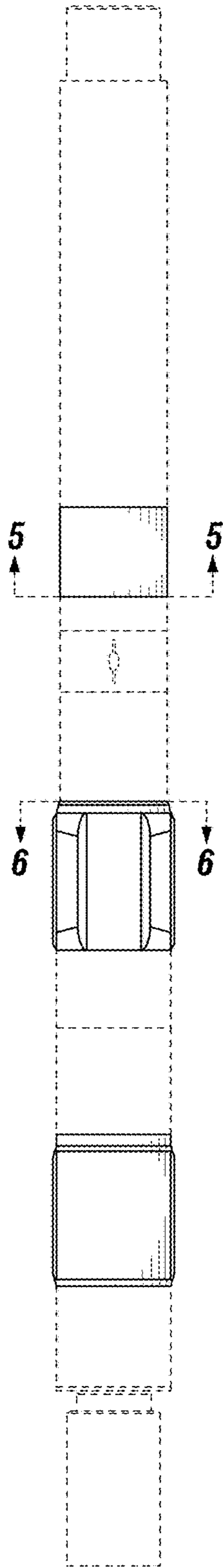

FIG. 1

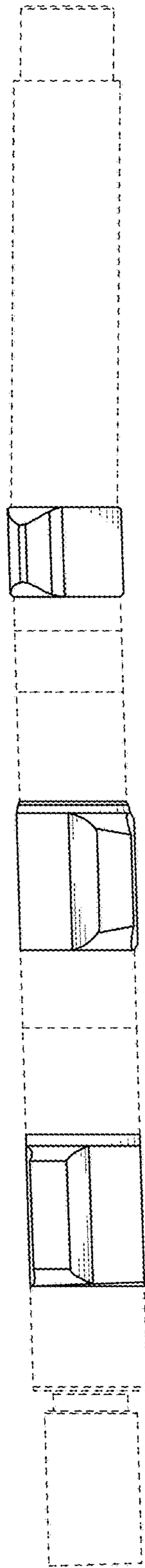

FIG. 2

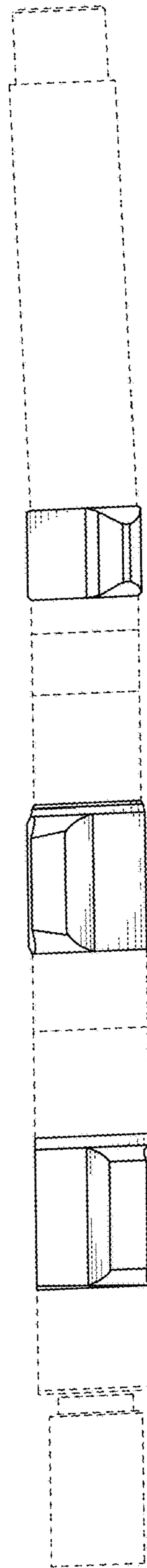

FIG. 3

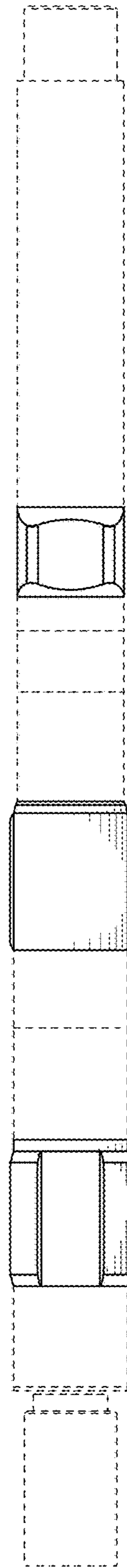

FIG. 4