



US00D863798S

(12) **United States Design Patent** (10) **Patent No.:** **US D863,798 S**  
**Klump et al.** (45) **Date of Patent:** **\*\* Oct. 22, 2019**

(54) **OTTOMAN FOR HOUSING PETS**  
(71) Applicant: **T1.C ENTERPRISES, LLC**, Portland, OR (US)  
(72) Inventors: **Rosalind Marinou Klump**, Portland, OR (US); **Patrick Lun**, Los Angeles, CA (US)  
(73) Assignee: **T1.C ENTERPRISES, LLC**, Portland, OR (US)

D330,274 S 10/1992 Smith  
D334,444 S 3/1993 Darby  
5,361,725 A 11/1994 Baillie et al.  
D361,378 S 8/1995 Mitchell  
(Continued)

**FOREIGN PATENT DOCUMENTS**

CN 2680104 Y 2/2005  
CN 104430002 A 3/2015  
(Continued)

(\*\*) Term: **15 Years**

**OTHER PUBLICATIONS**

(21) Appl. No.: **29/672,596**

The Koda Collection. [online] Published Nov. 2, 2016. Retrieved from URL: <http://momant.com>.\*

(22) Filed: **Dec. 6, 2018**

(Continued)

(51) **LOC (12) Cl.** ..... **06-01**

*Primary Examiner* — Vy N Koenig

(52) **U.S. Cl.**

(74) *Attorney, Agent, or Firm* — R. Reams Goodloe, Jr.

USPC ..... **D6/349**; D6/336; D30/108

(58) **Field of Classification Search**

USPC ..... D6/663, 664, 666, 667, 671–671.3, 657, D6/661, 662, 662.1, 691, 691.9, 694, 349, D6/336; D30/108–120

(57) **CLAIM**

The ornamental design for an ottoman for housing pets, as shown and described.

See application file for complete search history.

**DESCRIPTION**

(56) **References Cited**

**U.S. PATENT DOCUMENTS**

1,430,740 A 10/1922 Katz  
D168,650 S 1/1953 McKee  
D193,769 S 10/1962 Kerr  
D215,733 S 10/1969 Durando  
3,618,568 A 11/1971 Breeden  
D233,717 S 11/1974 Stewart  
3,872,832 A 3/1975 Quinn  
D266,526 S 10/1982 Raine  
D267,691 S \* 1/1983 White ..... D6/673  
D303,739 S 10/1989 Egarton  
D315,430 S 3/1991 Robertson  
D326,376 S \* 5/1992 Barfield ..... D6/661  
5,148,768 A 9/1992 Hinton

FIG. 1 is a perspective view of an ottoman for housing pets showing our new design.

FIG. 2 is a front side view thereof.

FIG. 3 is a back side view thereof.

FIG. 4 is a left side view thereof.

FIG. 5 is a right side view thereof.

FIG. 6 is a top plan view thereof; and,

FIG. 7 is a bottom plan view thereof.

In each of the drawing figures, surface shading is used to clearly show the character and contour of all surfaces of the 3-dimensional aspects of the design. The broken lines in the figures depict portions of the ottoman that form no part of the claimed design.

**1 Claim, 4 Drawing Sheets**

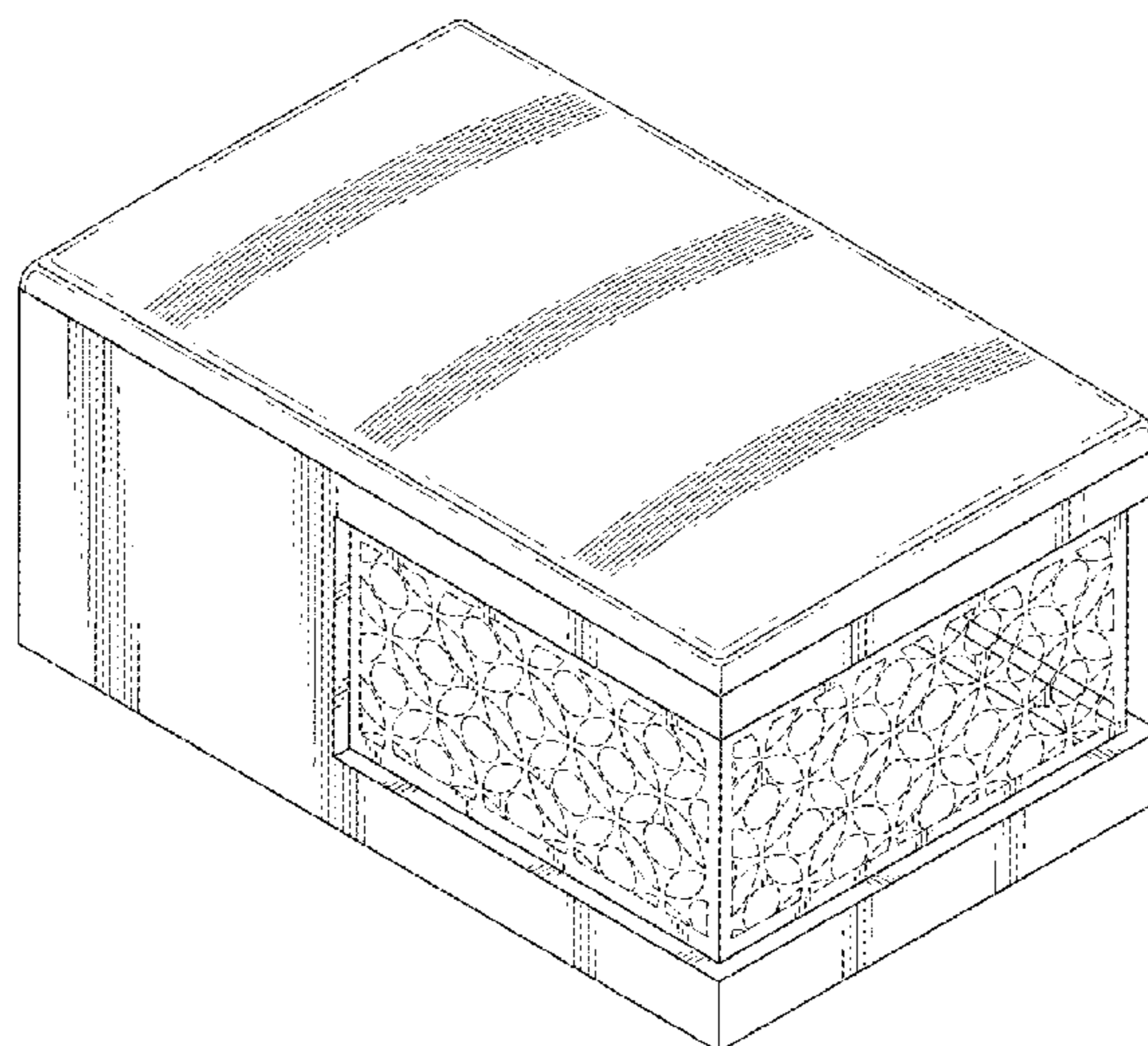

(56)

References Cited

U.S. PATENT DOCUMENTS

D388,912 S 1/1998 Hurst et al.  
 5,890,455 A 4/1999 Donchey  
 D427,730 S 7/2000 Powers et al.  
 D428,717 S 8/2000 Solowiej  
 D429,418 S \* 8/2000 Tisbo ..... D25/16  
 D432,818 S 10/2000 Hutton  
 6,182,612 B1 2/2001 Ross, Sr.  
 6,286,458 B1 9/2001 Rawson  
 D468,915 S 1/2003 Talbott  
 D481,496 S 10/2003 Sequino  
 D483,156 S 12/2003 Simpson  
 D509,380 S 9/2005 Lines  
 D512,799 S 12/2005 Simpson et al.  
 6,997,138 B1 2/2006 Simpson  
 D519,685 S \* 4/2006 Scarpaci ..... D30/108  
 D520,779 S 5/2006 DeBlois  
 D534,379 S 1/2007 Juneau  
 D553,879 S \* 10/2007 Juneau ..... D6/671  
 D554,389 S 11/2007 Pierce  
 D556,885 S 12/2007 Suri et al.  
 D610,314 S \* 2/2010 Ault ..... D30/118  
 D613,000 S 3/2010 Ward  
 7,673,585 B1 3/2010 Emmi et al.  
 D621,100 S 8/2010 Simpson  
 D640,837 S 6/2011 Henley  
 D680,696 S 4/2013 Hammel  
 D701,403 S 3/2014 Thompson  
 D704,901 S 5/2014 Diskin  
 D735,499 S \* 8/2015 Stein ..... D6/663  
 D739,004 S 9/2015 Carroll  
 D788,499 S \* 6/2017 Anderson ..... D6/667  
 D801,729 S 11/2017 Price  
 D815,364 S 4/2018 Lara  
 D821,038 S 6/2018 Rathman  
 D829,024 S 9/2018 Mejia

2002/0152969 A1 10/2002 Grigsby et al.  
 2006/0071519 A1 4/2006 Heide et al.  
 2006/0112897 A1 6/2006 Moore  
 2007/0000448 A1 1/2007 Dietz  
 2007/0089683 A1 4/2007 Roberts et al.  
 2009/0031964 A1 2/2009 Proxmire  
 2009/0064939 A1 3/2009 Cirincione et al.  
 2017/0097169 A1 4/2017 Azevedo  
 2017/0188538 A1 7/2017 Rathman et al.

FOREIGN PATENT DOCUMENTS

EP 2260698 A2 12/2010  
 FR 2584567 A1 1/1987  
 GB 2118015 A 10/1983  
 JP 2000-41517 A 2/2000  
 JP 2009-219418 A 1/2009  
 JP 2011-097892 A 5/2011  
 KR 10-2042-0062979 A 6/2012  
 WO WO 2012/077858 A1 6/2012

OTHER PUBLICATIONS

Google search—wire-dog-crate (search date—Jun. 24, 2018)—5pgs.  
 Google search—dog-crate-furniture (search date—Jun. 24, 2018)—4pgs.  
 Google search—furniture and dog and table and decoralive and screen (search date—Jun. 24, 2018)—2pgs.  
 Den Haus (<https://denhaus.com/collections/dens>) (4pgs).  
 Barkitecture ph ([https://www.instagram.com/barkitecture.ph/?utm\\_source=ig\\_embed](https://www.instagram.com/barkitecture.ph/?utm_source=ig_embed))(4 pgs).  
 Omlet Fido Studio ([https://www.omlet.us/shop/dog\\_prpdicts/fido\\_studio\\_dog\\_crate/](https://www.omlet.us/shop/dog_prpdicts/fido_studio_dog_crate/)) (12pgs).

\* cited by examiner

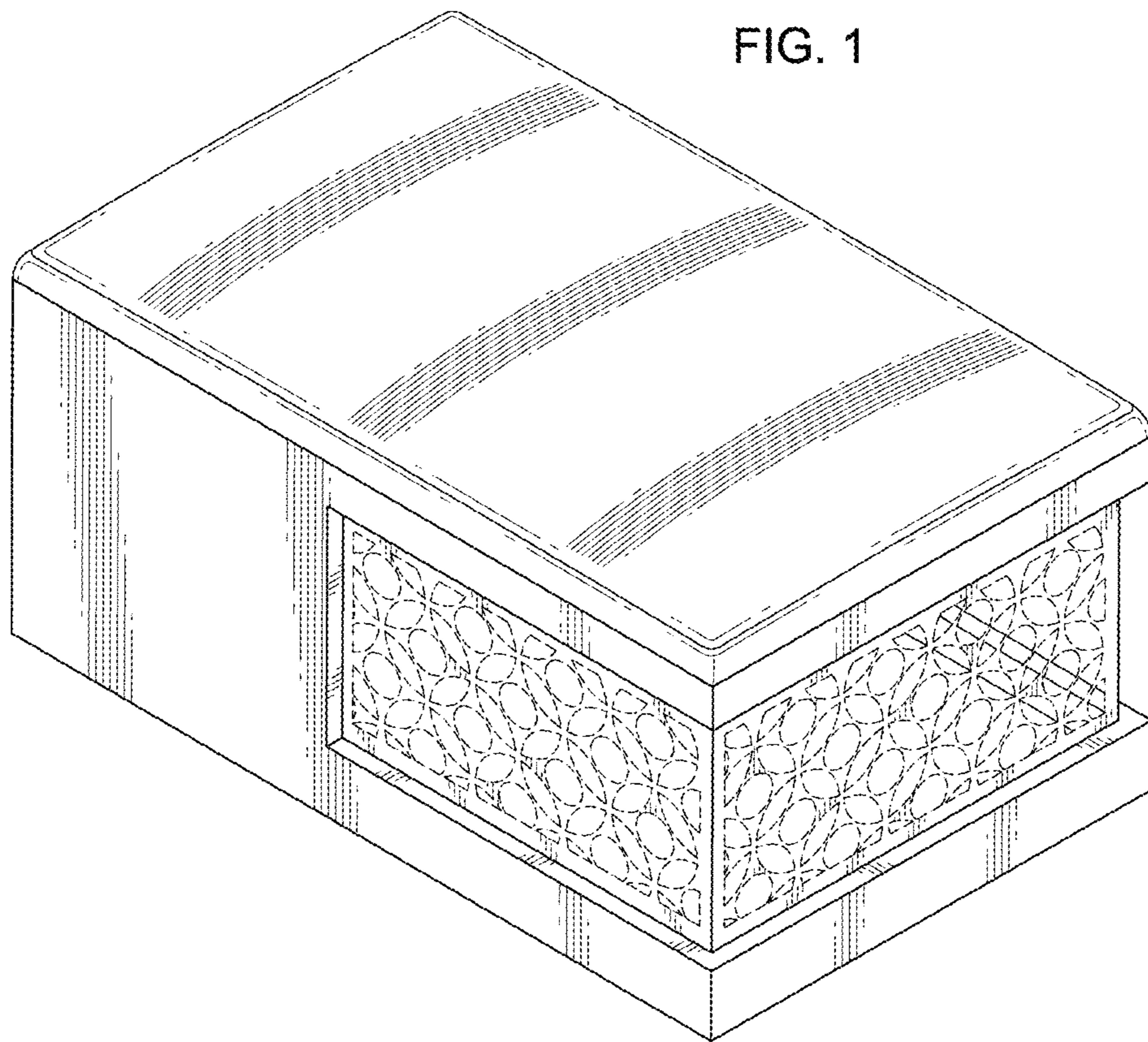

FIG. 2

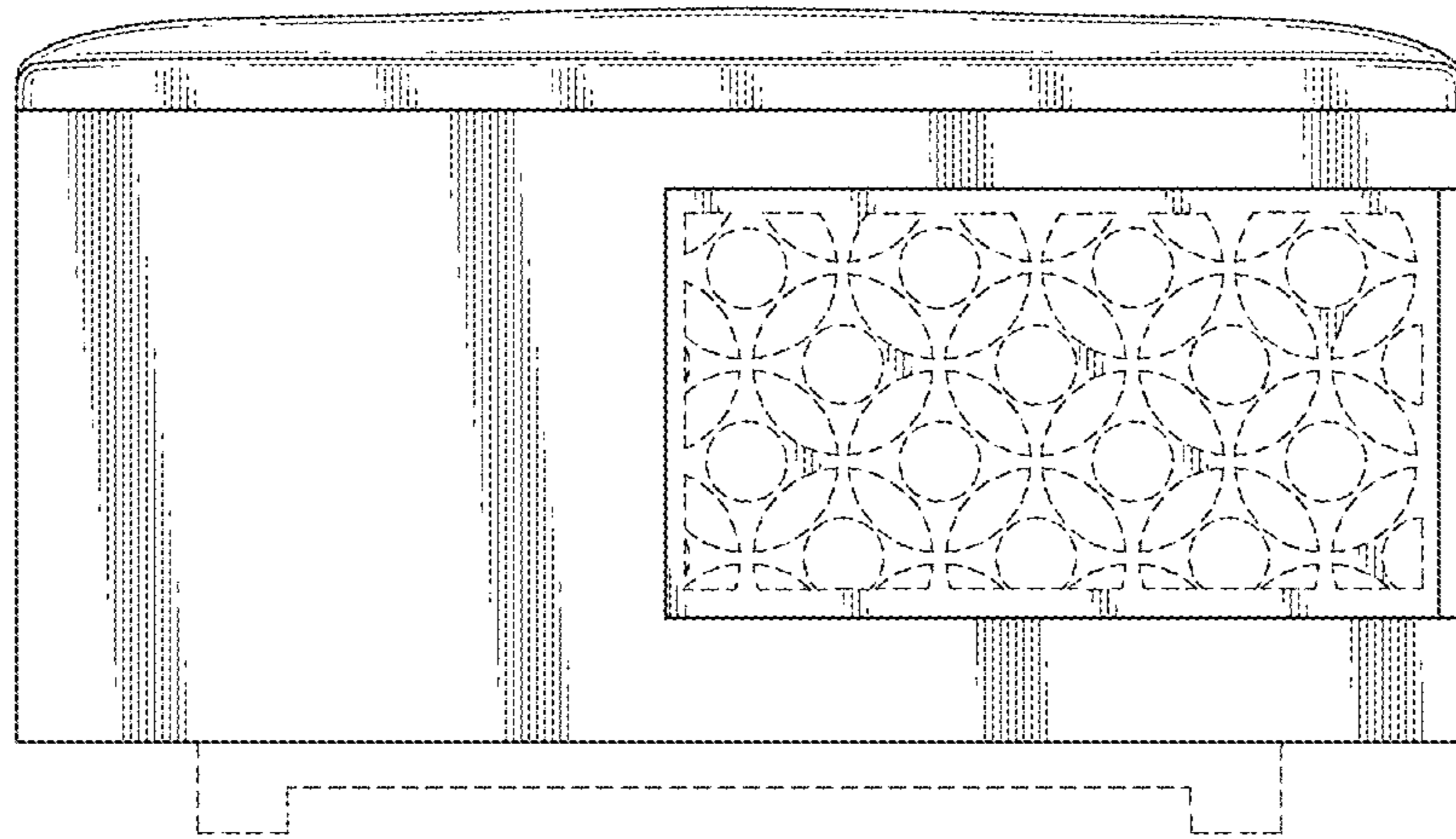

FIG. 3

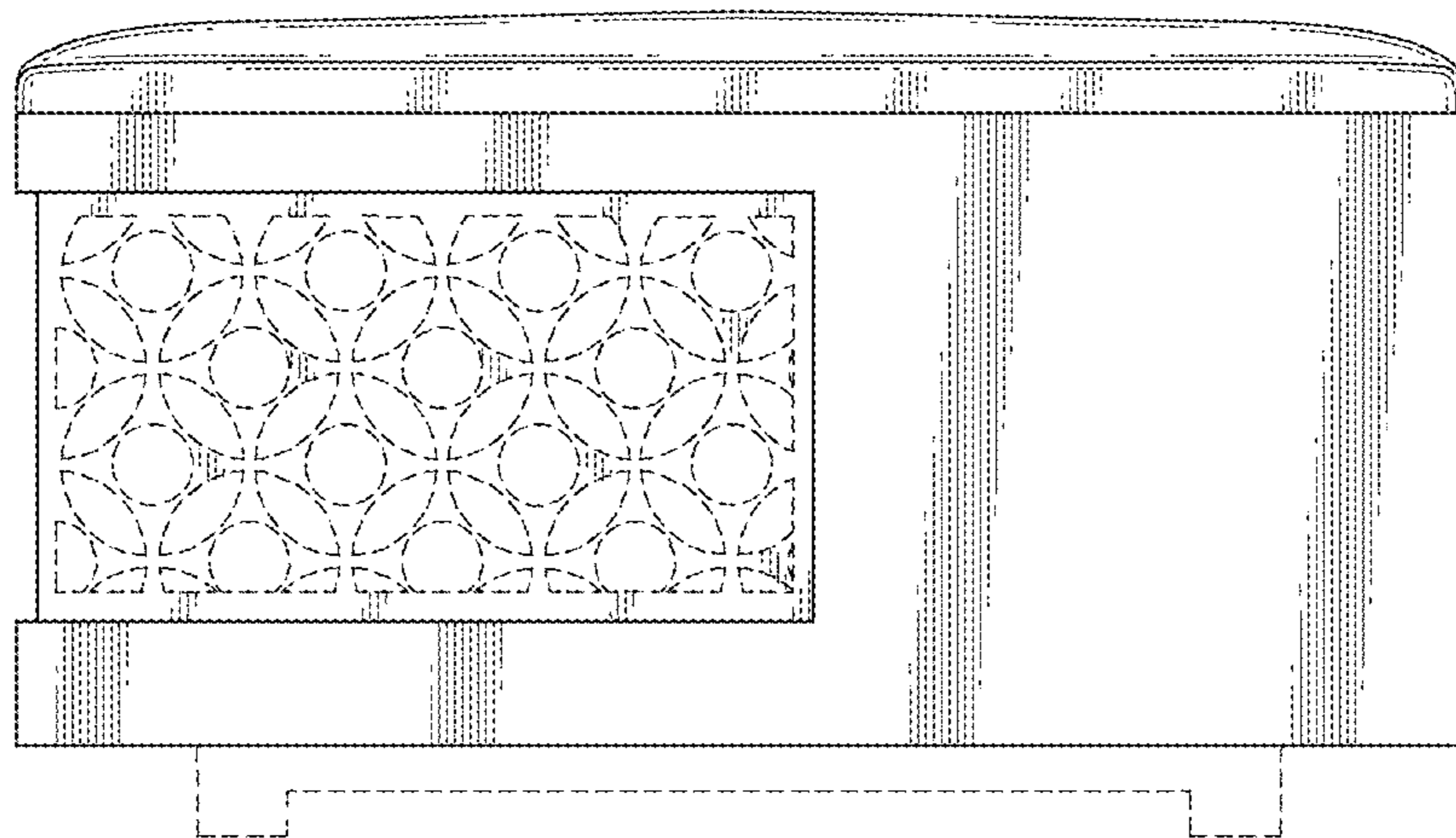

FIG. 4

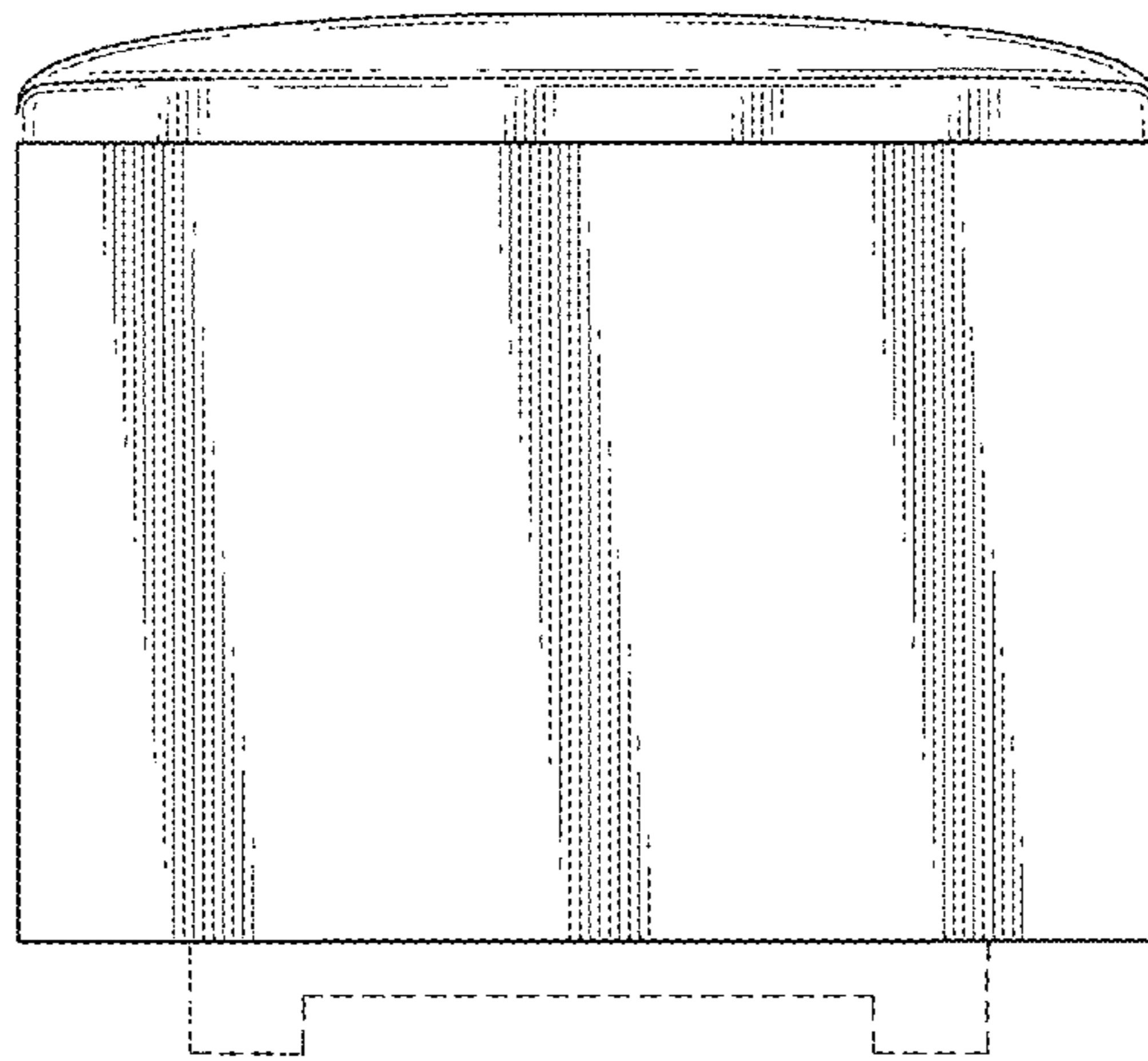

FIG. 5

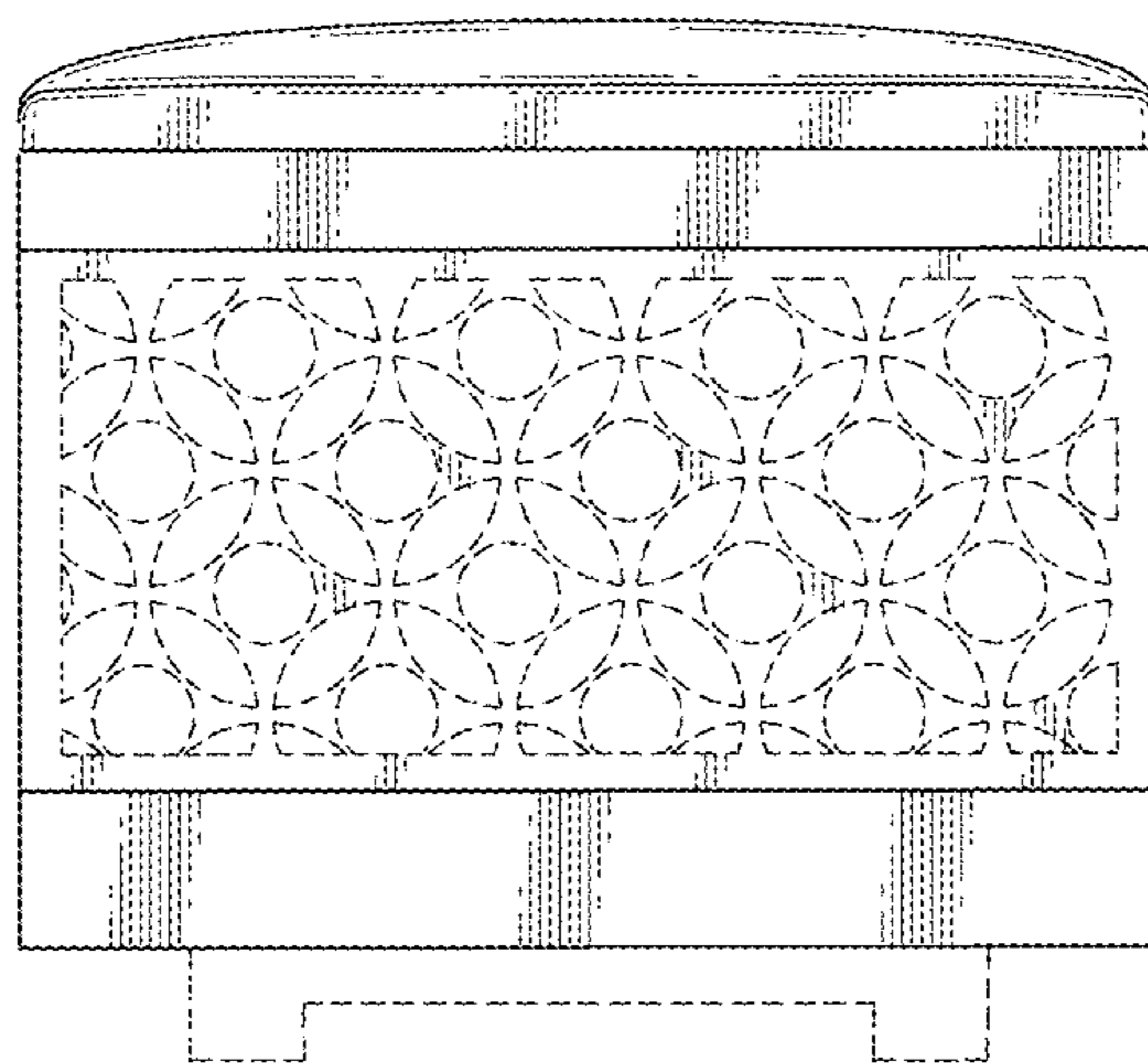

FIG. 6

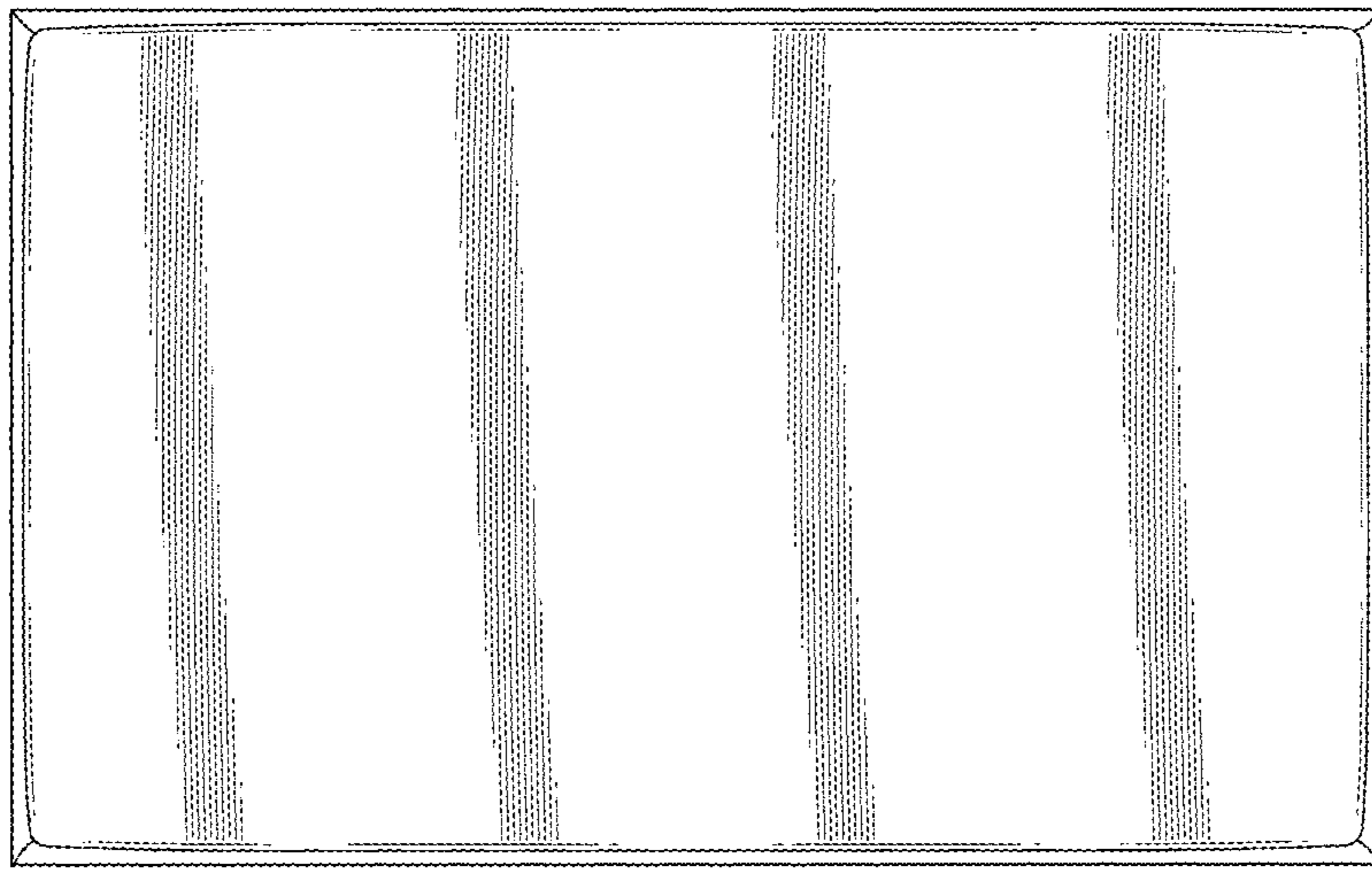
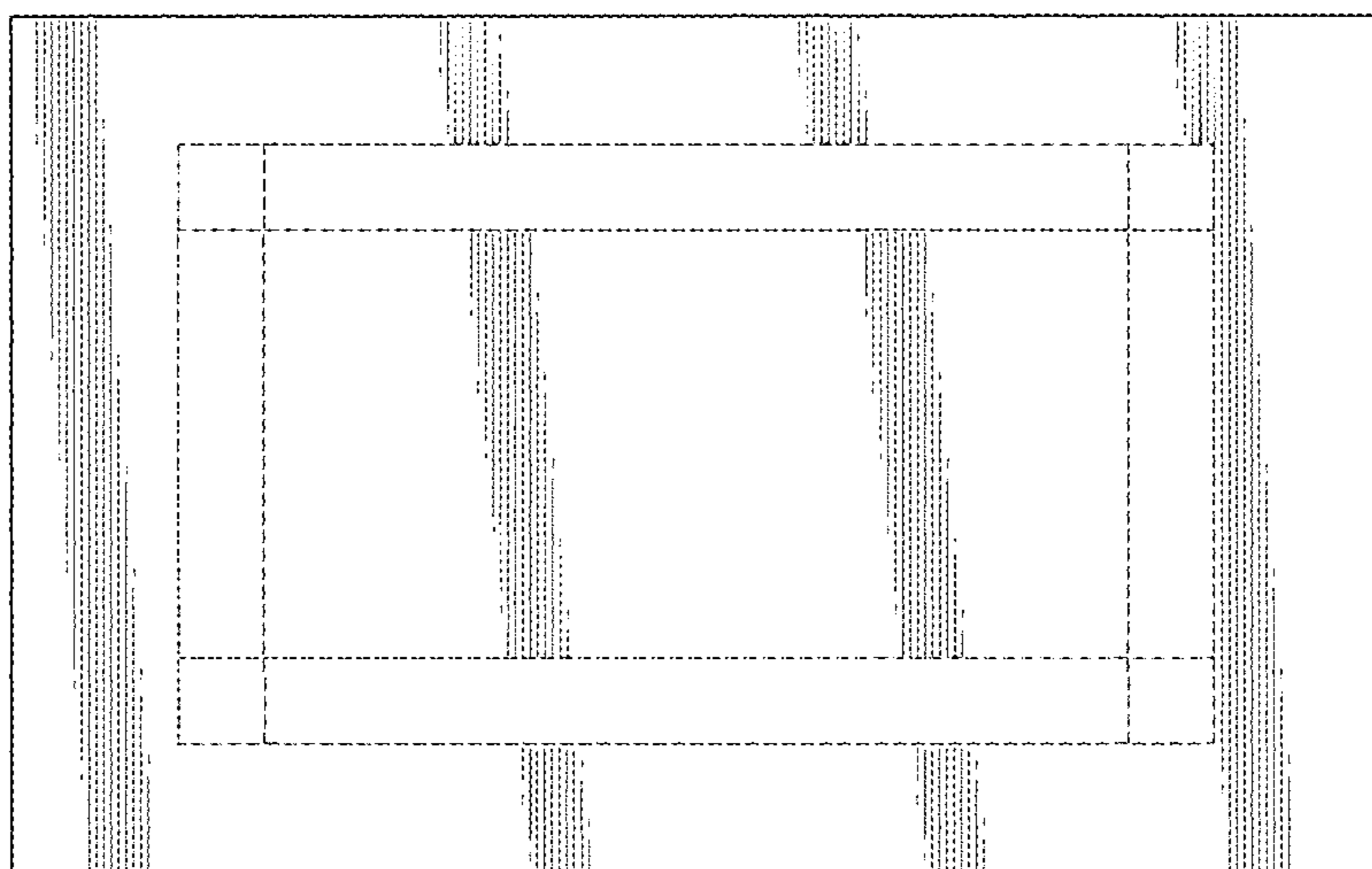

FIG. 7



UNITED STATES PATENT AND TRADEMARK OFFICE  
**CERTIFICATE OF CORRECTION**

PATENT NO. : D863,798 S  
APPLICATION NO. : 29/672596  
DATED : October 22, 2019  
INVENTOR(S) : Rosalind Marinou Klump and Patrick Lun

Page 1 of 1

It is certified that error appears in the above-identified patent and that said Letters Patent is hereby corrected as shown below:

On the Title Page

Under "Description", after the words "Fig. 6 is a top plan view thereof;", delete "and,".

On page 2, item (56), under "Foreign Patent Documents", after the words "KR", delete "10-2042-0062979 A" and substitute therefore --10-2012-0062979 A--.

On page 2, item (56), under "Other Publications", after the words "screen (search date—Jun. 24, 2018)—", delete "2pgs." and substitute therefore --7pgs.--.

On page 2, item (56), under "Other Publications", delete "Barklitecture" and substitute therefore --Barkitecture--.

Signed and Sealed this  
Fifth Day of May, 2020

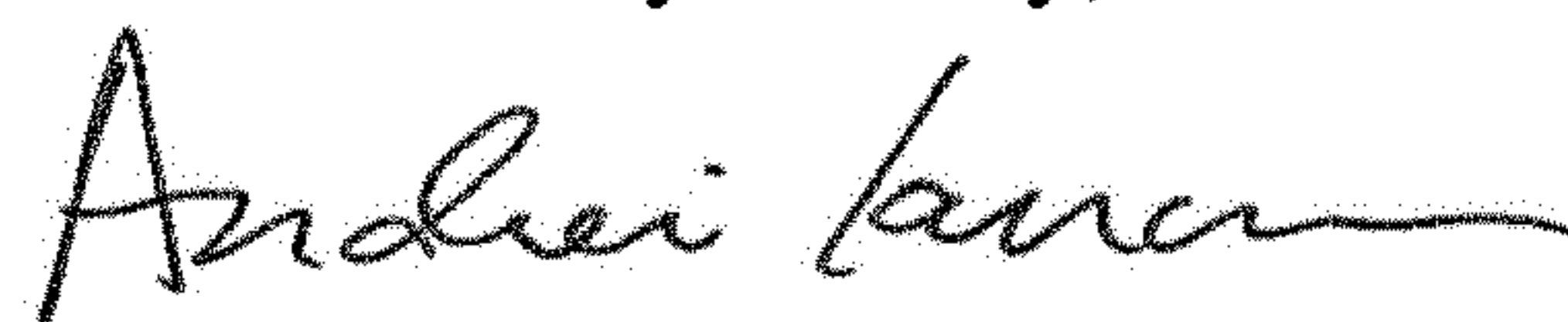

Andrei Iancu  
*Director of the United States Patent and Trademark Office*