

US00D863779S

(12) **United States Design Patent** (10) **Patent No.:** **US D863,779 S**
Appelbaum et al. (45) **Date of Patent:** **** Oct. 22, 2019**

- (54) **SOAP DISPENSING BRUSH**
- (71) Applicant: **Helen of Troy Limited**, Belleville, St. Michael (BB)
- (72) Inventors: **Alaina Appelbaum**, New York, NY (US); **Joseph Michael Zeledon**, Grand Rapids, MI (US)
- (73) Assignee: **Helen of Troy Limited**, St. Michael (BB)
- (**) Term: **15 Years**
- (21) Appl. No.: **29/636,803**
- (22) Filed: **Feb. 12, 2018**

D452,616 S *	1/2002	Varriale	D4/138
D452,776 S *	1/2002	Petner	D4/138
D495,844 S *	9/2004	Berti	D32/51
D495,883 S *	9/2004	Berti	D4/138
D514,329 S *	2/2006	Kampel	D4/128
D524,549 S *	7/2006	Ajluni	D4/128
D525,064 S *	7/2006	Williams	D6/524
D576,801 S *	9/2008	Dretzka	D4/116
D581,676 S *	12/2008	Libman	D4/128
D598,200 S *	8/2009	DiAntonio	D4/116
D628,393 S *	12/2010	Burridge	D4/127
D647,703 S *	11/2011	Li	D4/128
D694,018 S *	11/2013	Williams	D4/128
D710,617 S *	8/2014	Mink	D4/135
D713,646 S *	9/2014	Mink	D4/135
D817,004 S *	5/2018	Appelbaum	D4/114
10,136,720 B2 *	11/2018	Hasegawa	A45D 34/042
10,334,941 B2 *	7/2019	Hanneken	A46B 5/00

* cited by examiner

Related U.S. Application Data

- (62) Division of application No. 29/577,673, filed on Sep. 14, 2016, now Pat. No. Des. 817,004.
- (51) **LOC (12) Cl.** **04-01**
- (52) **U.S. Cl.**
USPC **D4/114**
- (58) **Field of Classification Search**
USPC D4/102, 109, 111-122, 128-131,
D4/136-138, 199; D23/223-225;
D6/551; 15/23, 186-188, 159.1, 160, 168
CPC A46B 15/00; A46B 11/00; A46B 5/00
See application file for complete search history.

References Cited

U.S. PATENT DOCUMENTS

D383,612 S *	9/1997	Chan	D4/138
D413,470 S *	9/1999	Burton	D6/551
D418,304 S *	1/2000	Ancona	D4/114
D433,859 S *	11/2000	Fiegl	D6/551
D448,176 S *	9/2001	Petner	D4/119

Primary Examiner — Kevin K Rudzinski

Assistant Examiner — Mehri F Bajoul

(74) *Attorney, Agent, or Firm* — Rankin, Hill & Clark LLP

(57) **CLAIM**

The ornamental design for a soap dispensing brush, as shown and described.

DESCRIPTION

FIG. 1 is a perspective view of a soap dispensing brush; FIG. 2 is a front elevation view thereof; FIG. 3 is a left side elevation view thereof; FIG. 4 is a right side elevation thereof; FIG. 5 is a rear elevation view view thereof; FIG. 6 is a top plan view thereof; and, FIG. 7 is a bottom plan view thereof.

The broken lines depicted in the figures form no part of the claimed design.

1 Claim, 3 Drawing Sheets

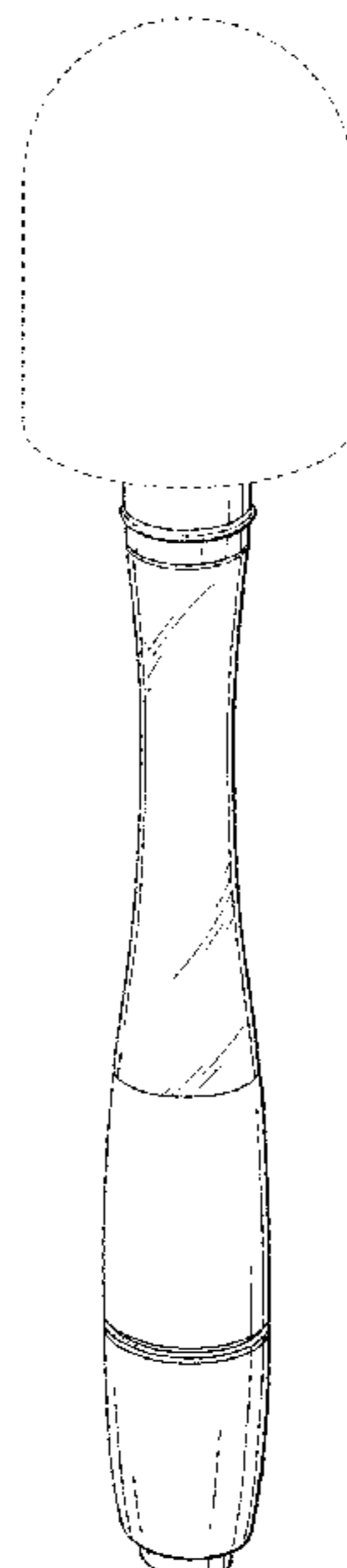

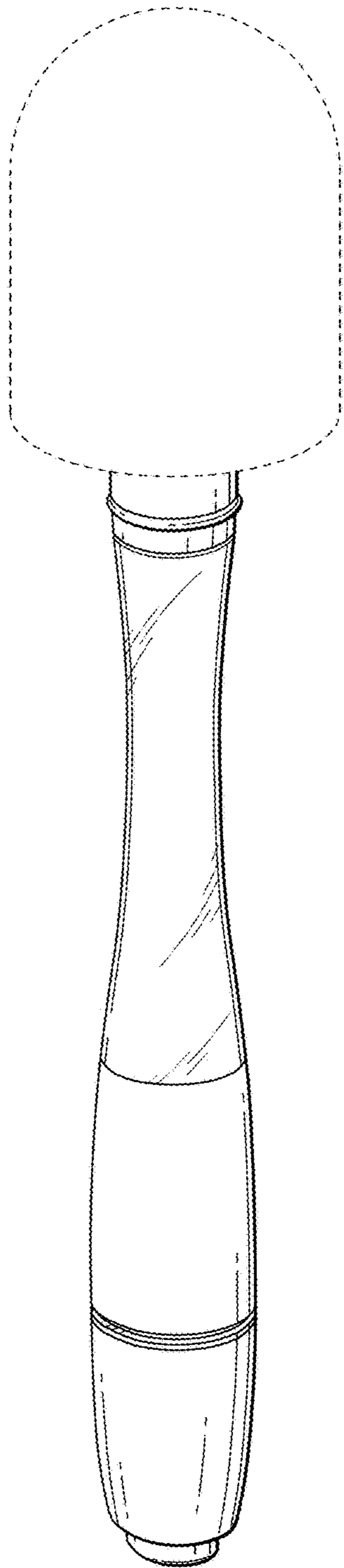

FIG. 1

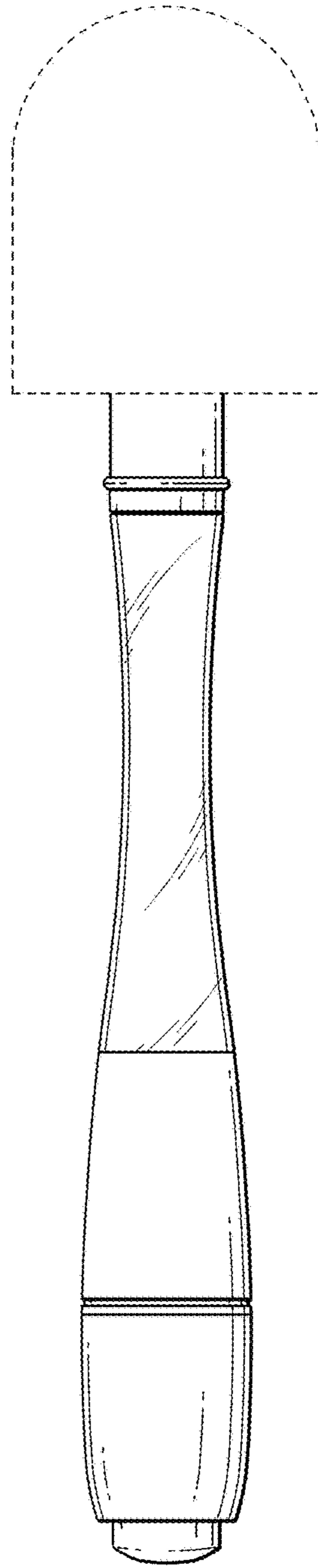

FIG. 2

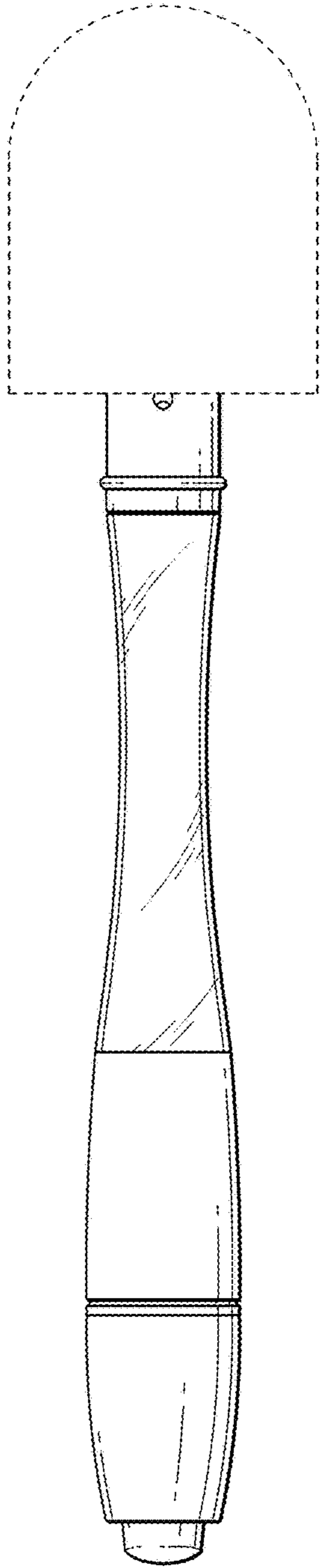

FIG. 3

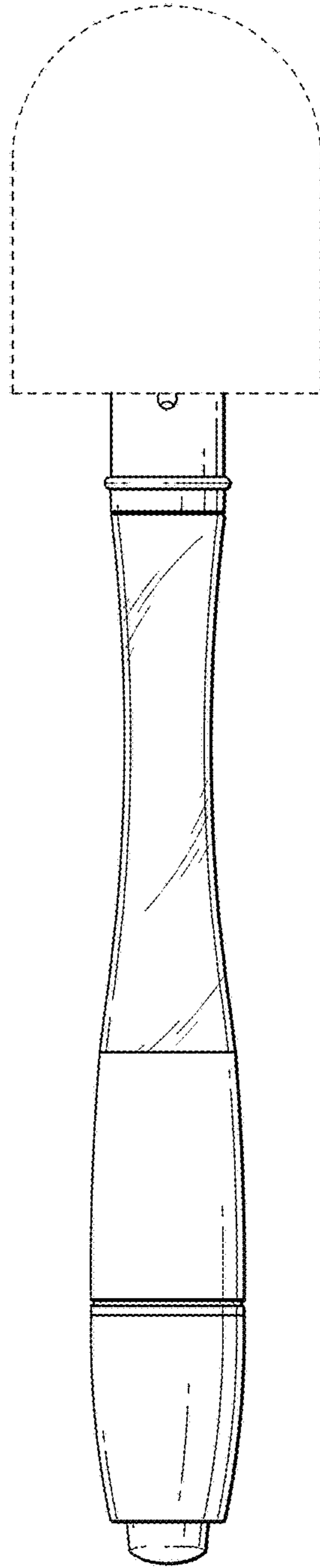

FIG. 4

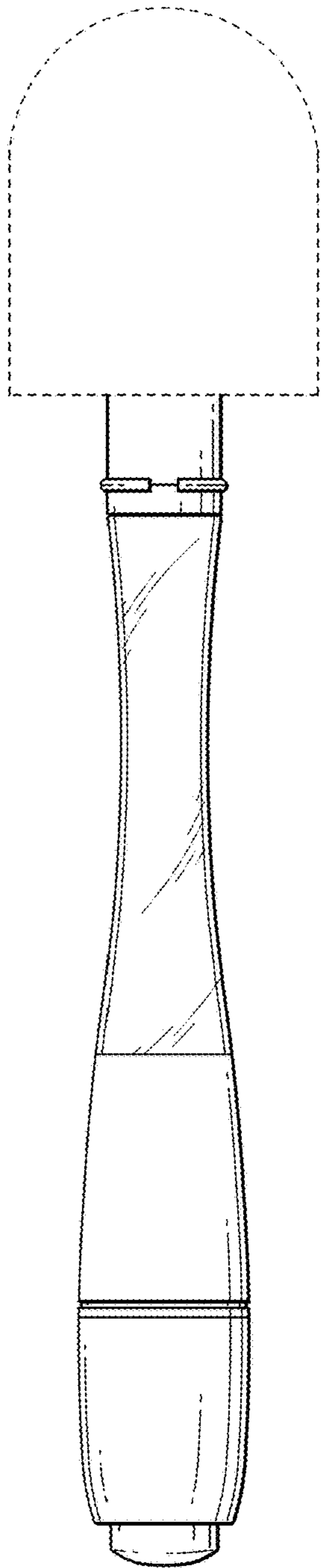

FIG. 5

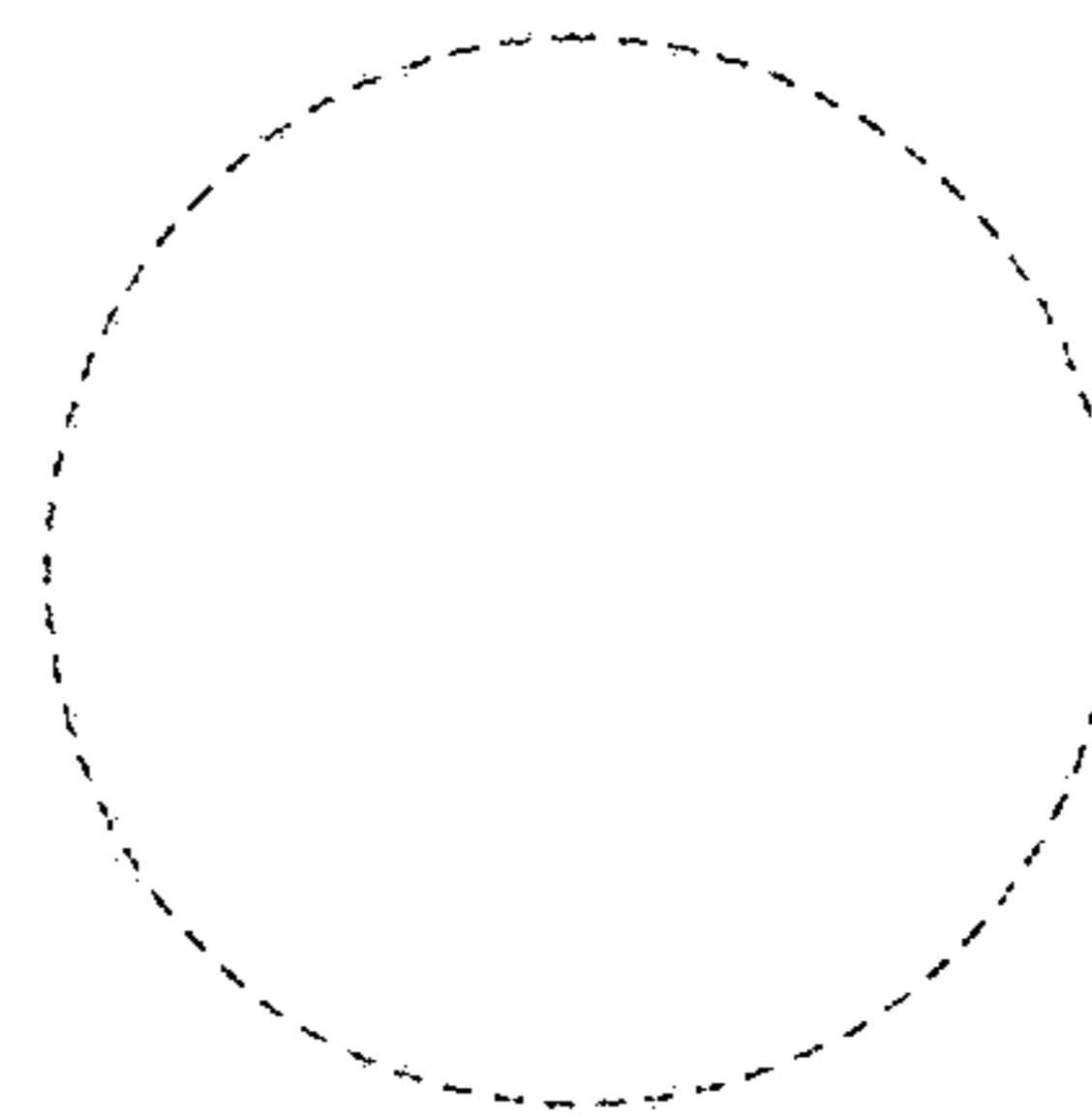

FIG. 6

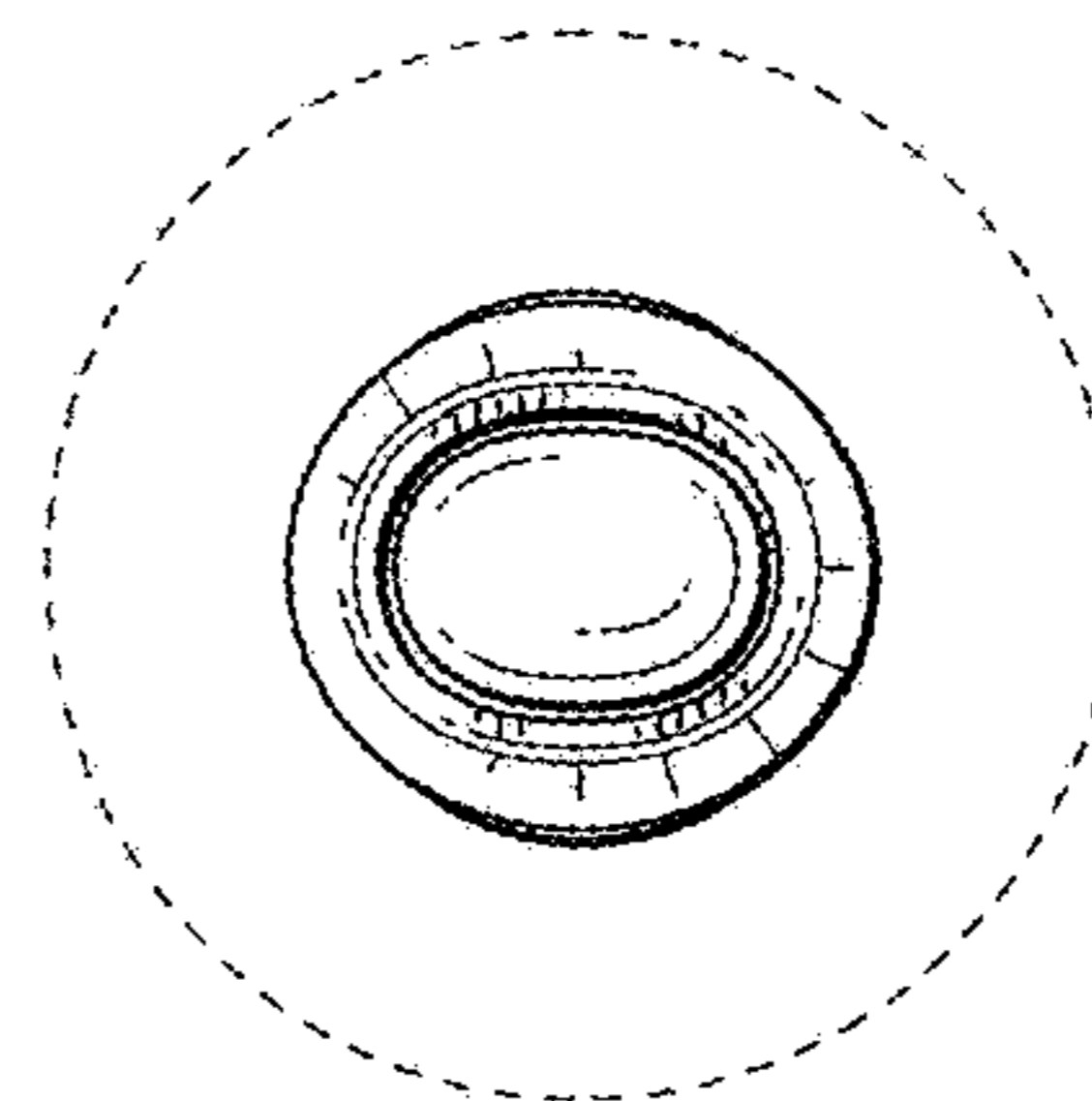

FIG. 7