

US00D863762S

(12) **United States Design Patent** (10) **Patent No.:** **US D863,762 S**
Urrutia (45) **Date of Patent:** **** Oct. 22, 2019**

(54) **RECEIVER FOR TAPE KNIFE AND EXCESS COMPOUND**

2012/0104057 A1* 5/2012 Gerrior A45F 5/021
224/183

(71) Applicant: **Jose Urrutia**, Sacramento, CA (US)

* cited by examiner

(72) Inventor: **Jose Urrutia**, Sacramento, CA (US)

Primary Examiner — Catherine R Oliver-Garcia
(74) *Attorney, Agent, or Firm* — Mark C. Jacobs

(**) Term: **15 Years**

(21) Appl. No.: **29/651,011**

(57) **CLAIM**

(22) Filed: **Oct. 17, 2017**

The ornamental design for a receiver for a tape knife and excess compound, as shown and described.

(51) **LOC (12) Cl.** **03-01**

(52) **U.S. Cl.**
USPC **D3/269**

DESCRIPTION

(58) **Field of Classification Search**
USPC D3/269, 272–274, 307, 315, 905, 276,
D3/281–282, 284, 292, 294, 201, 270;
D8/71; D32/74; 15/257.1; 294/3.5;
224/270, 232, 249, 251, 673, 678, 183
CPC .. A45F 5/02; A45F 5/021; A45F 5/004; A45F
2200/0575; A45F 2200/05
See application file for complete search history.

FIG. 1 is a front perspective view of the receiver for a tape knife and excess compound showing my new design; FIG. 2 is a front perspective view thereof, shown in use; FIG. 3 is a front elevation view thereof; FIG. 4 is a rear elevation view thereof; FIG. 5 is a left side view thereof; FIG. 6 is a right side view thereof; FIG. 7 is a top plan view thereof; FIG. 8 is a bottom plan view thereof; FIG. 9 is a front perspective view of the second embodiment of the receiver for a tape knife and excess compound; FIG. 10 is a front perspective view thereof, shown in use; FIG. 11 is a front elevation view thereof; FIG. 12 is a rear elevation view thereof; FIG. 13 is a left side view thereof; FIG. 14 is a right side view thereof; FIG. 15 is a top plan view thereof; and, FIG. 16 is a bottom plan view thereof.

(56) **References Cited**

U.S. PATENT DOCUMENTS

- 3,343,735 A * 9/1967 Breeding E04F 21/16
224/242
- D278,512 S * 4/1985 Lojko 15/257.1
- 5,826,762 A * 10/1998 Dellinger A45F 5/02
224/270
- 9,463,662 B1 * 10/2016 Sotolongo A45F 5/021
- D828,026 S * 9/2018 Cavazos, III D3/269
- D833,847 S * 11/2018 Gabaldon D8/71
- 2003/0019896 A1 * 1/2003 Karpati A45F 5/00
224/270
- 2003/0230615 A1 * 12/2003 Jones A45F 5/00
224/677

The broken lines depict environmental structure and are included for the purpose of illustrating only and form no part of the claimed design.

1 Claim, 6 Drawing Sheets

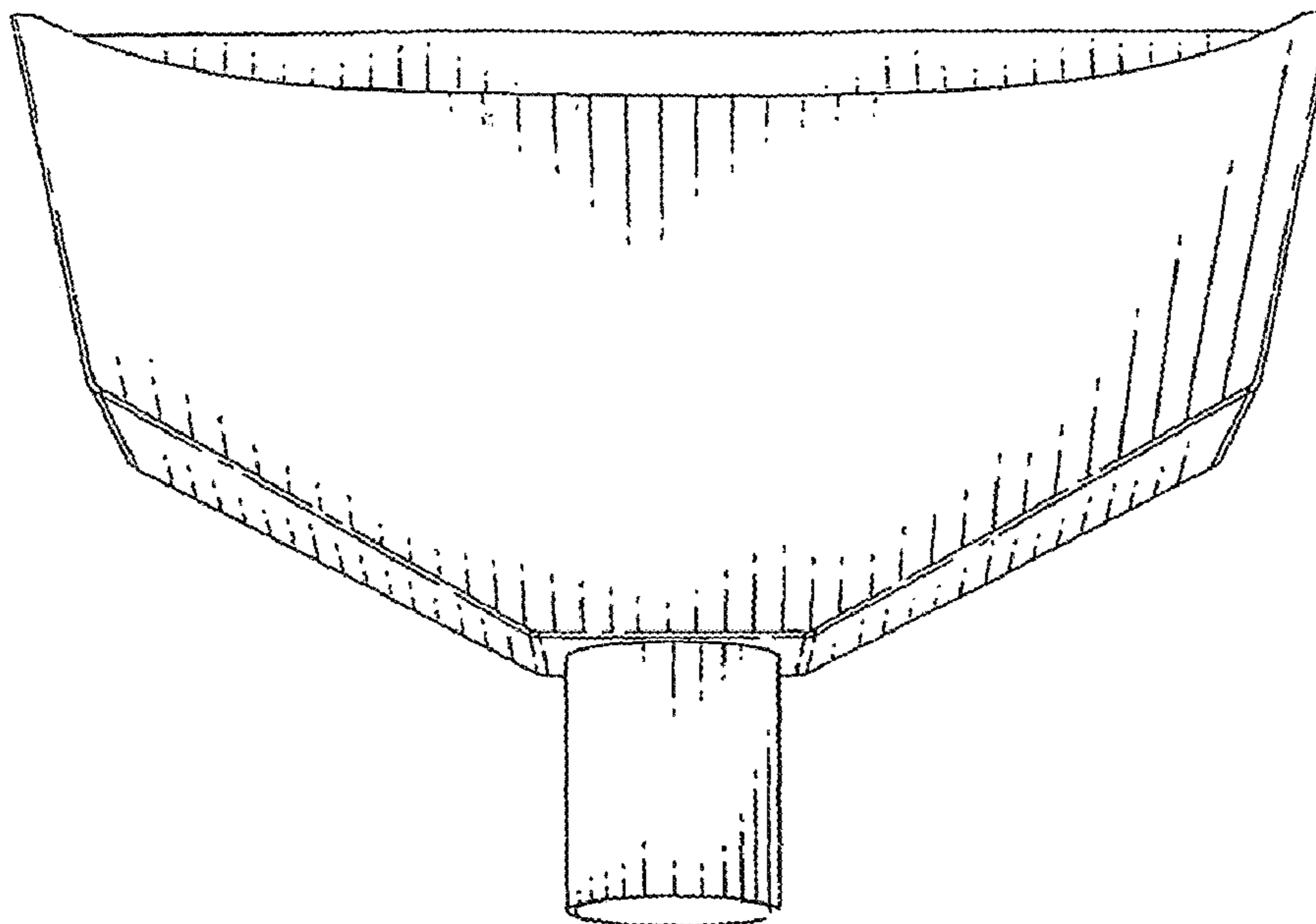

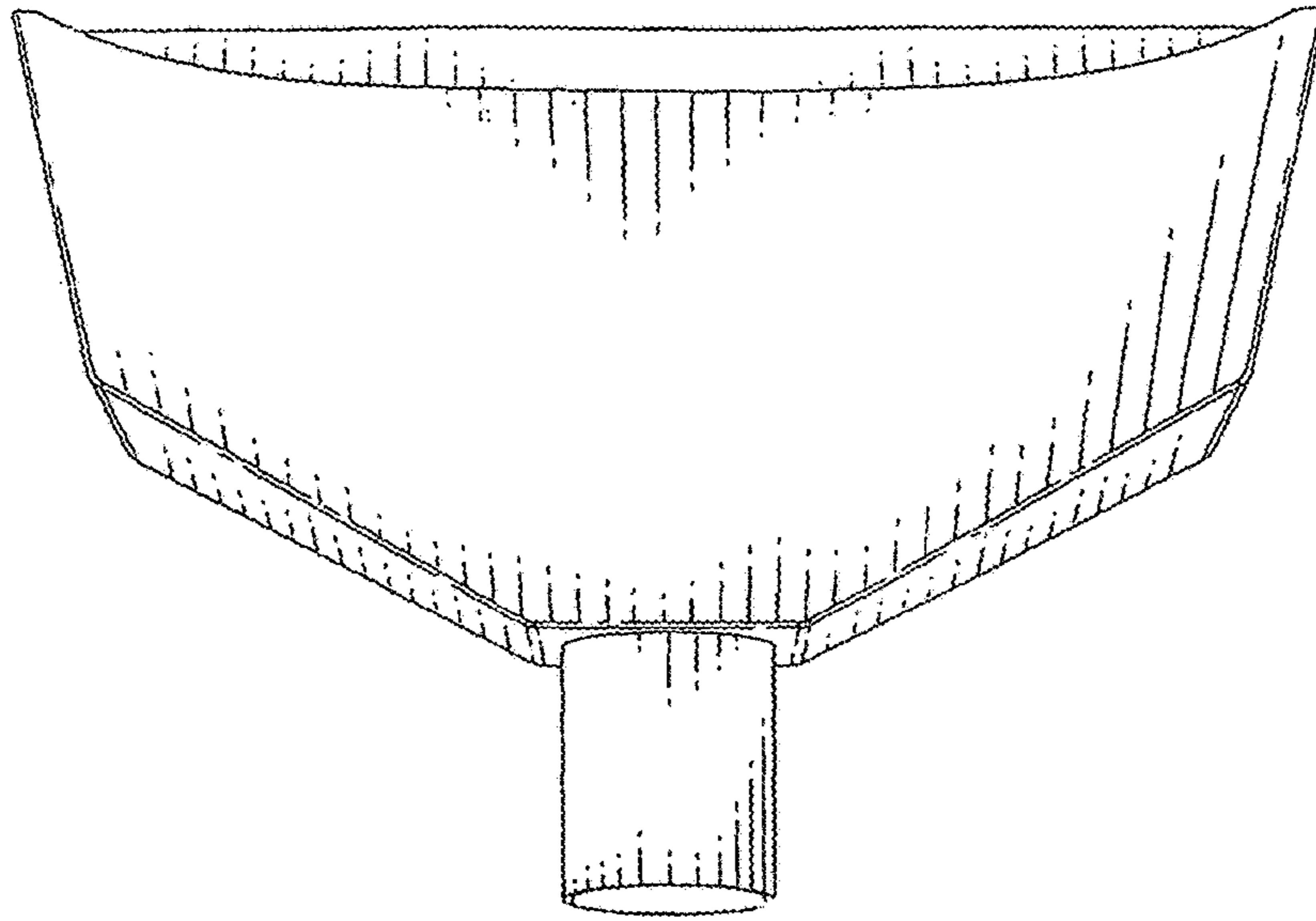

FIG. 1

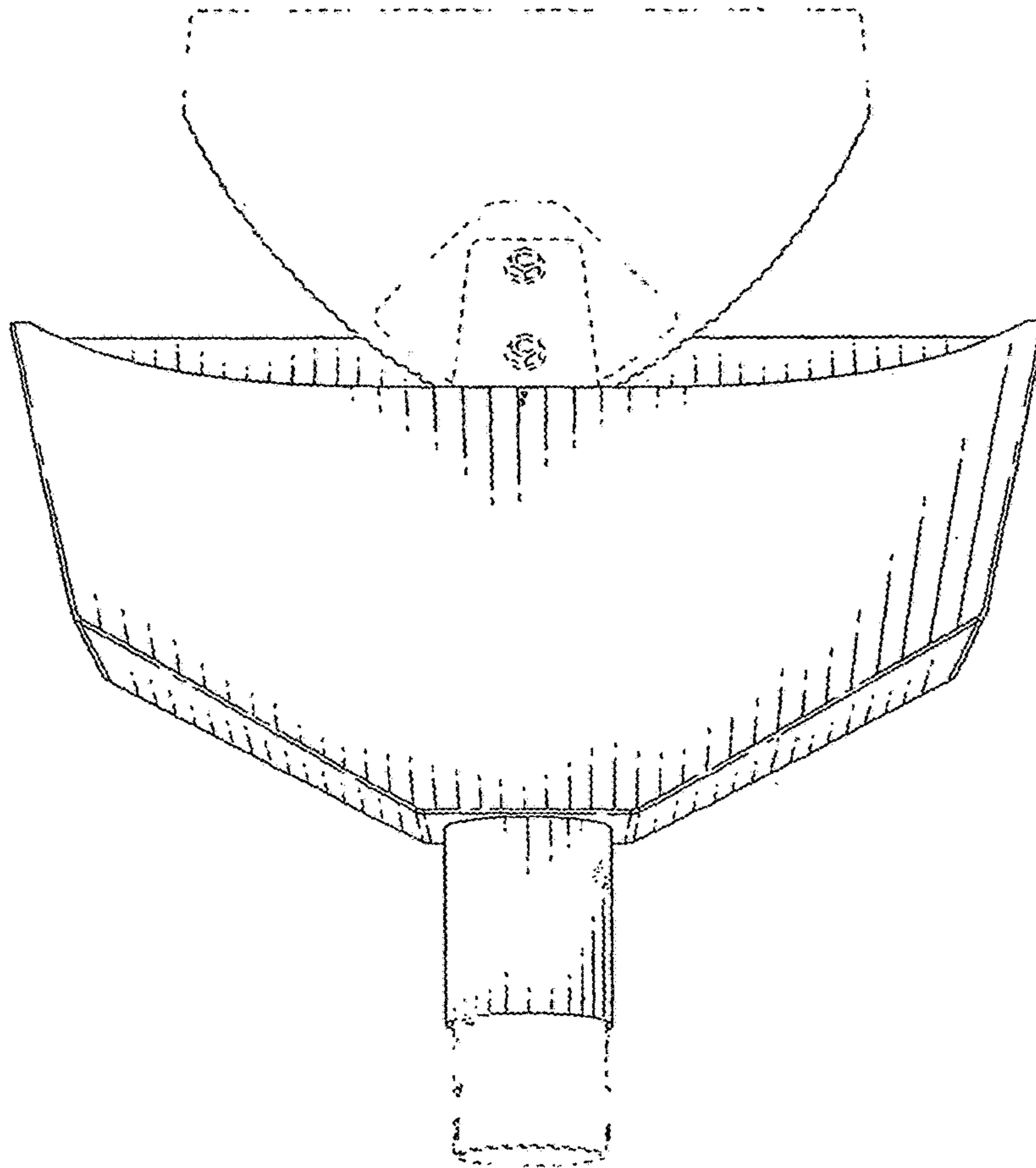

FIG. 2

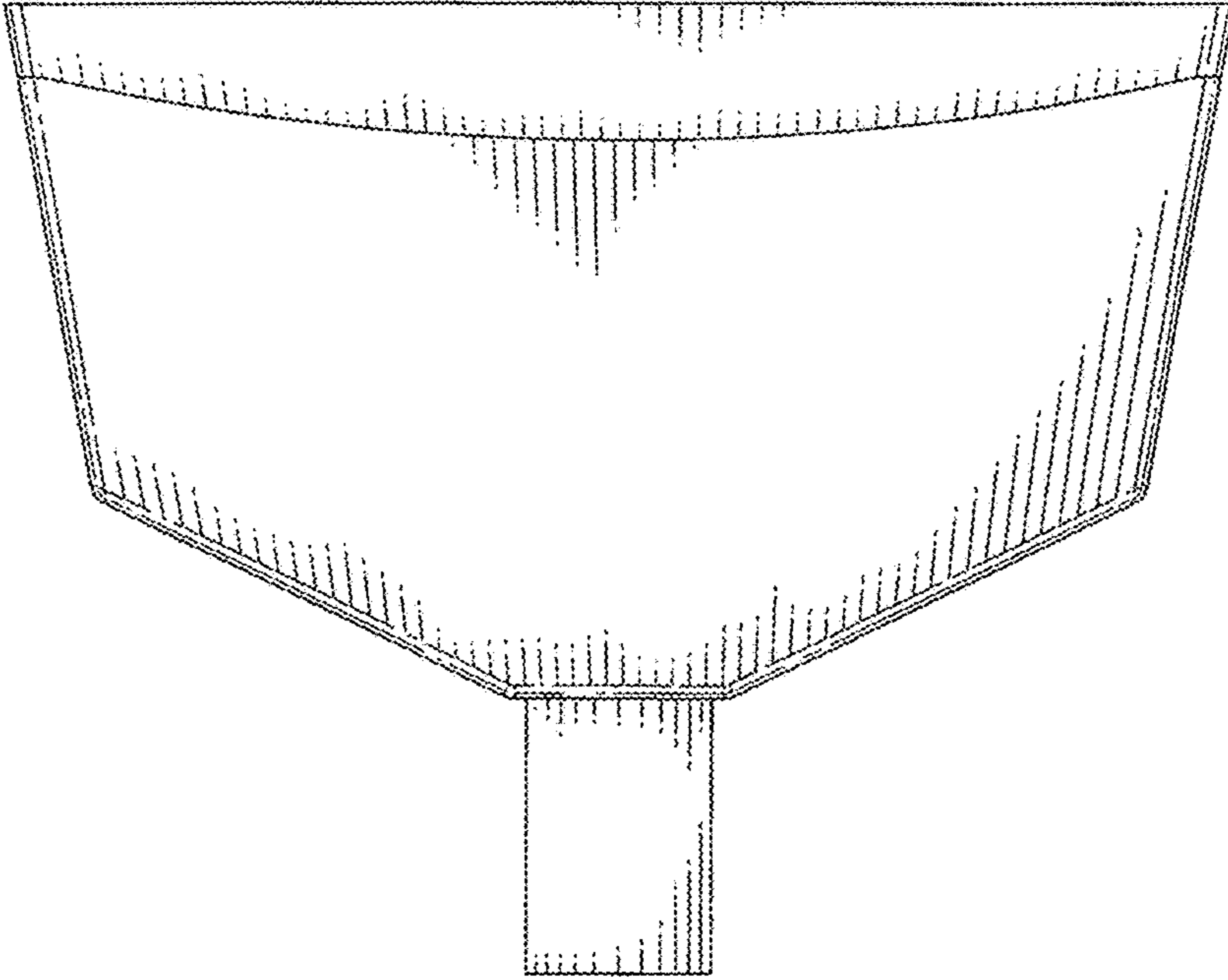

FIG. 3

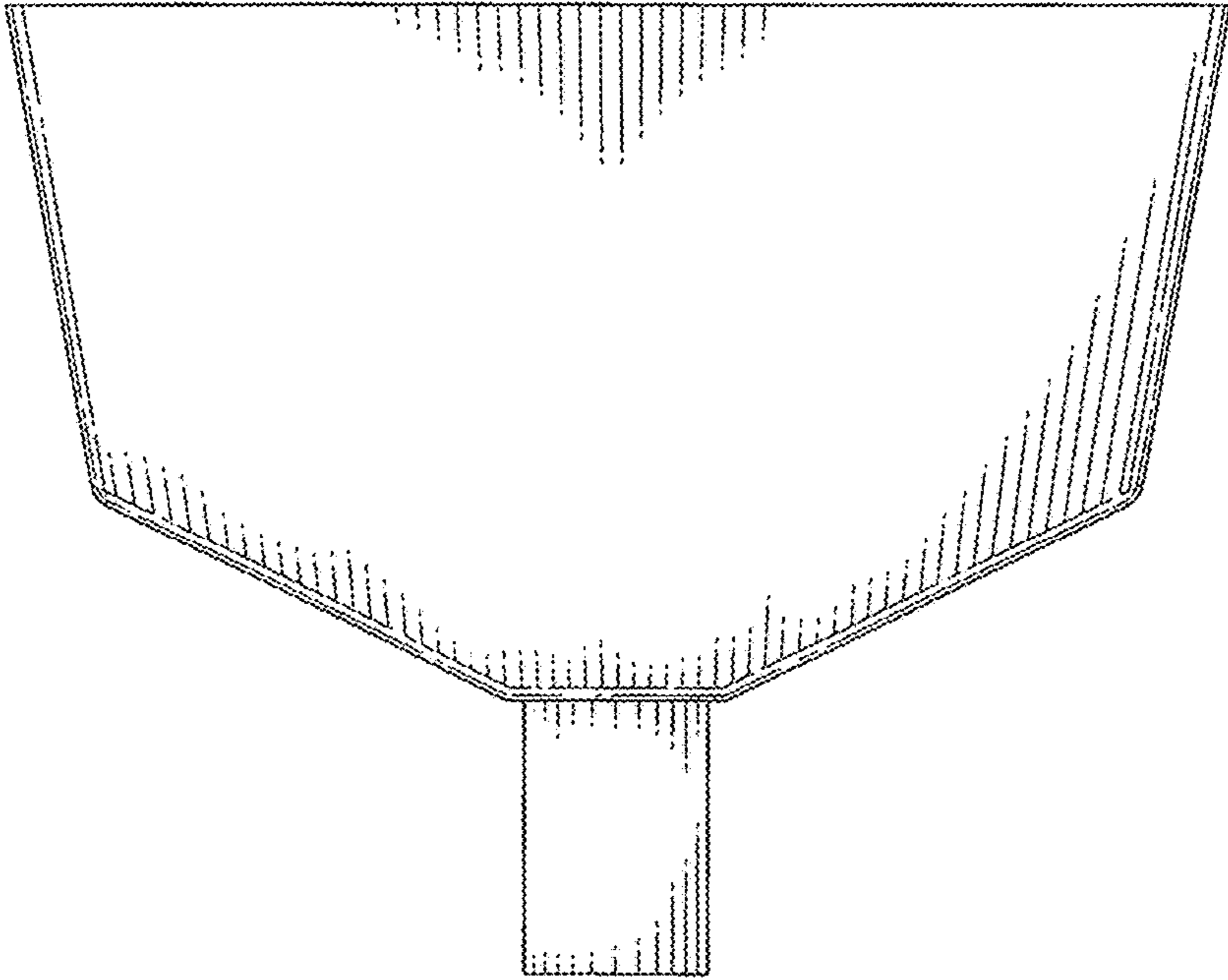

FIG. 4

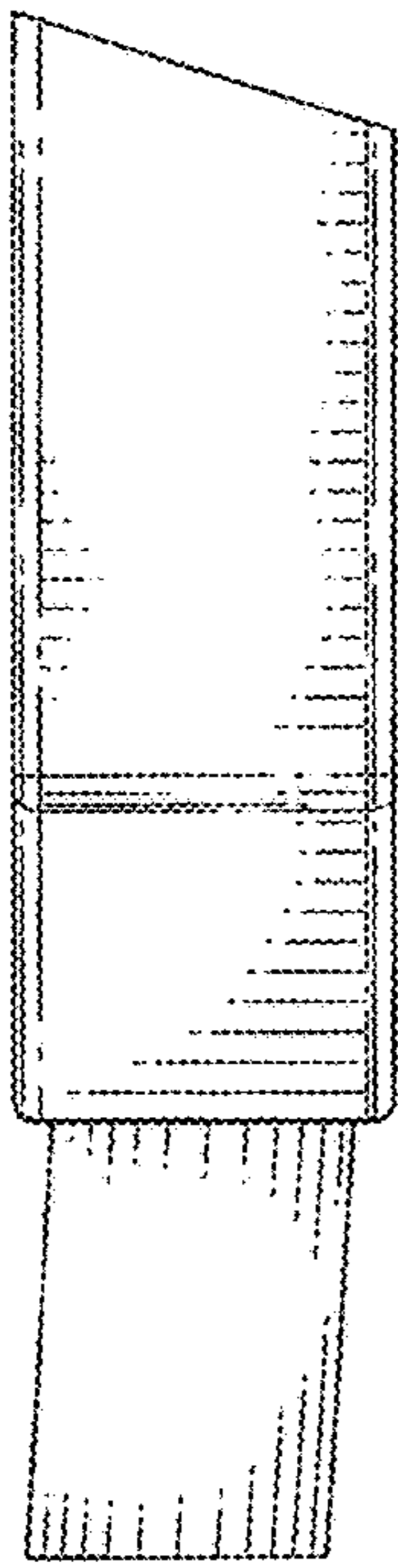

FIG. 5

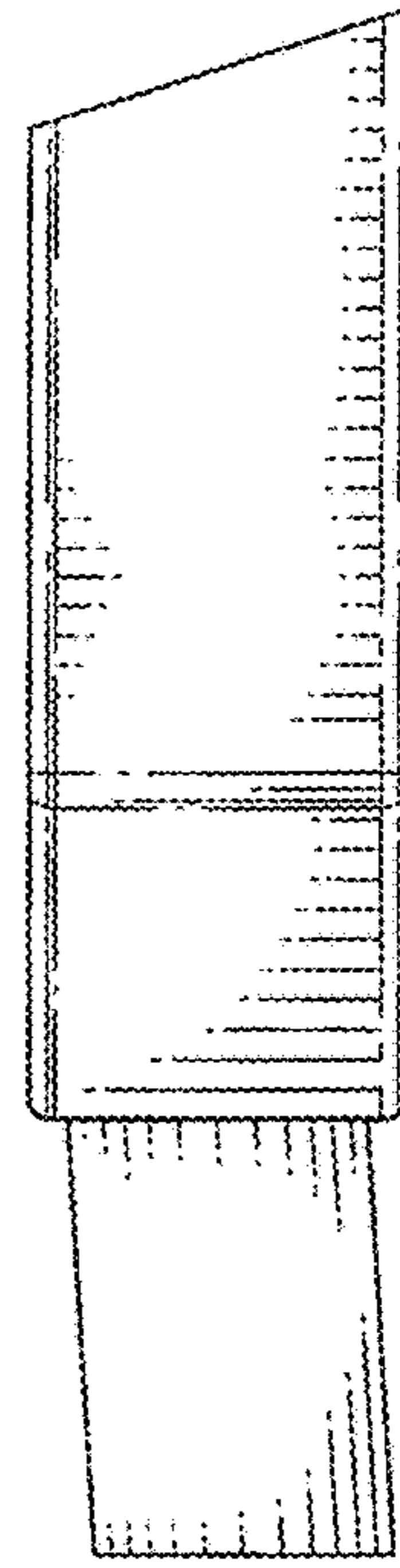

FIG. 6

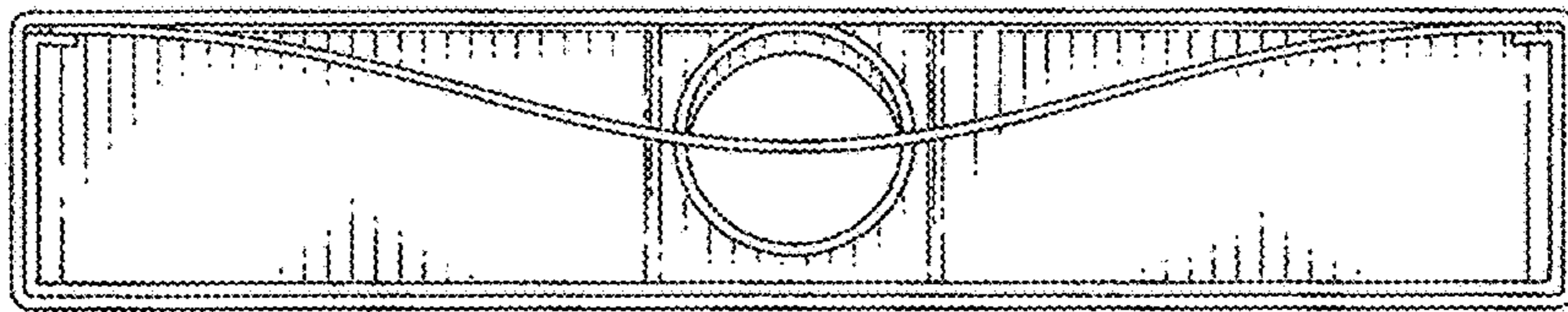

FIG. 7

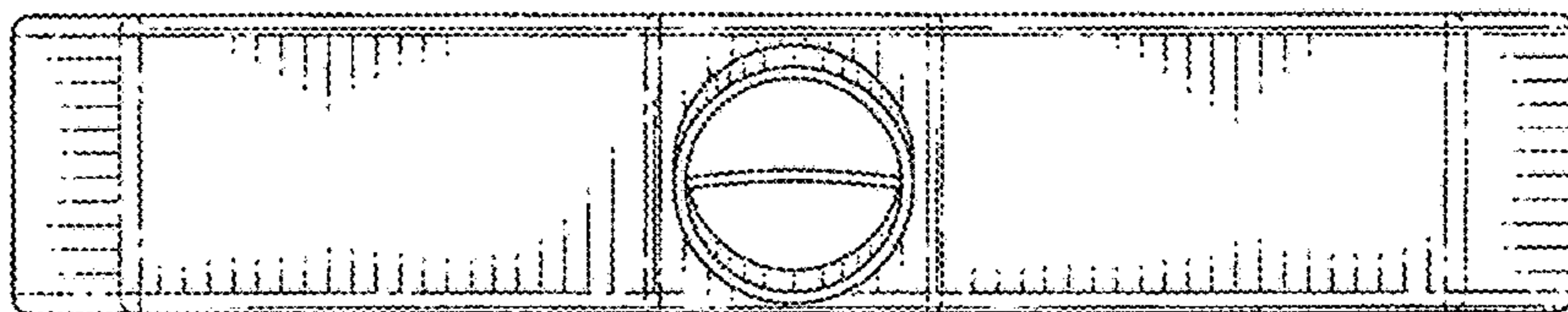

FIG. 8

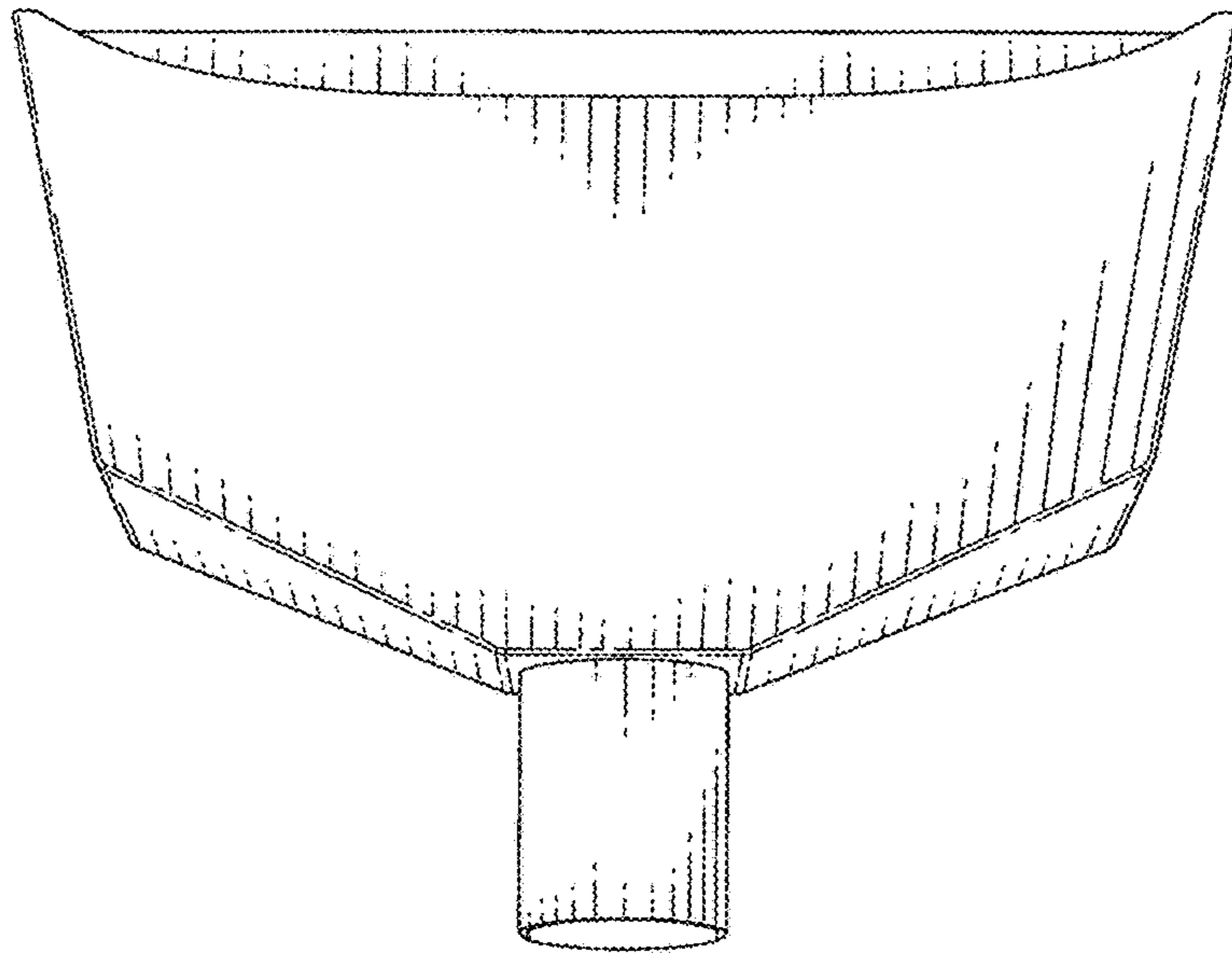

FIG. 9

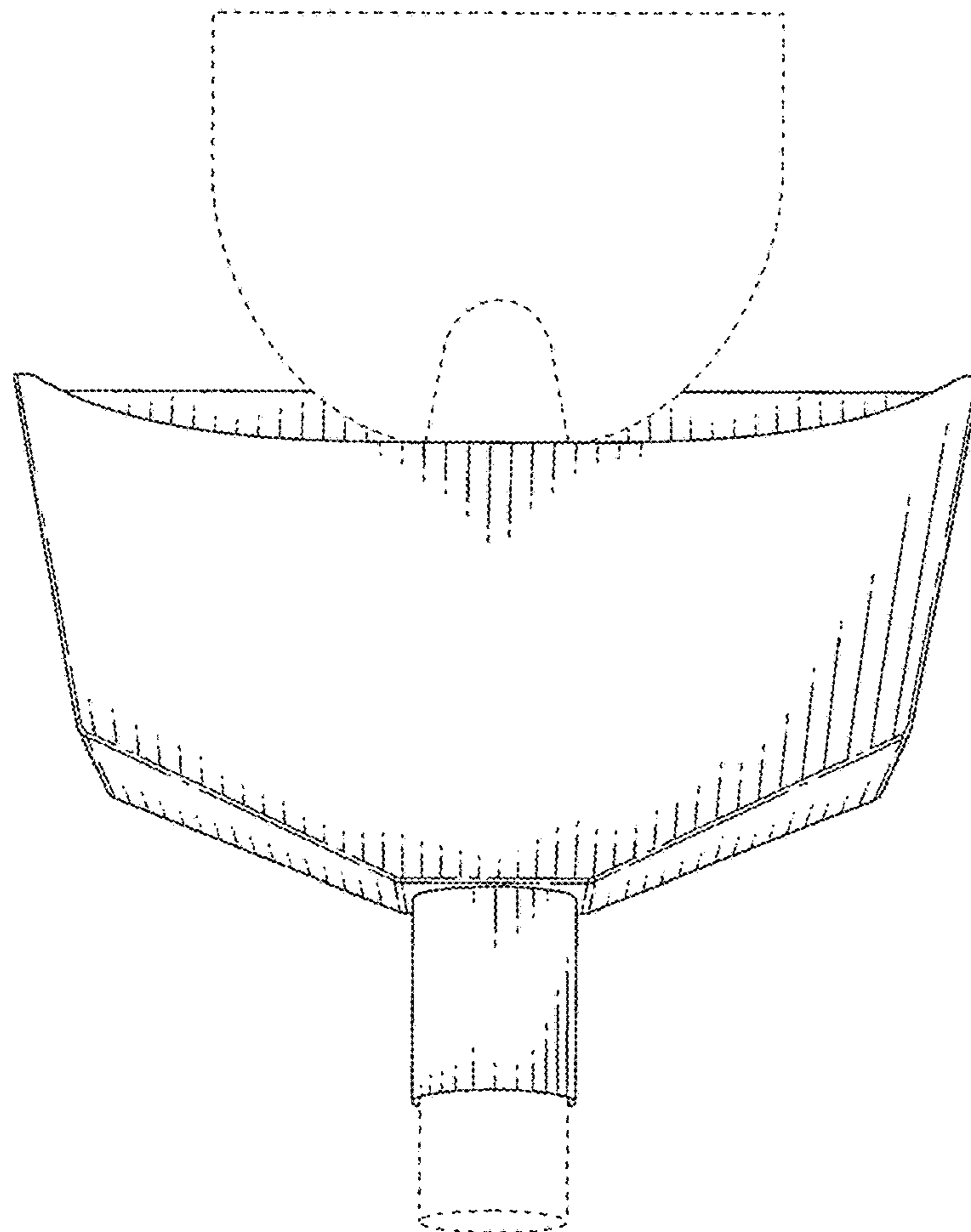

FIG. 10

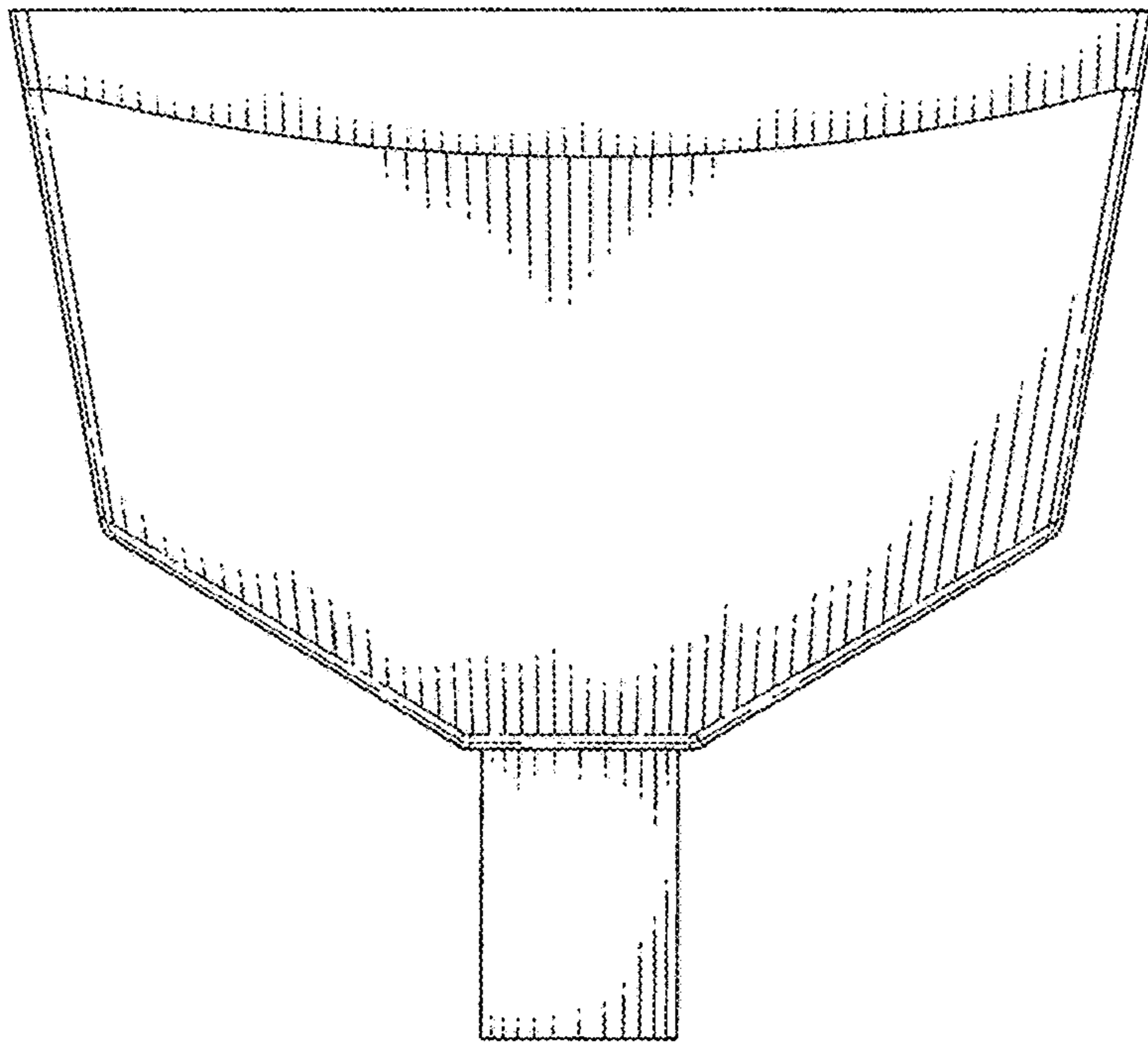

FIG. 11

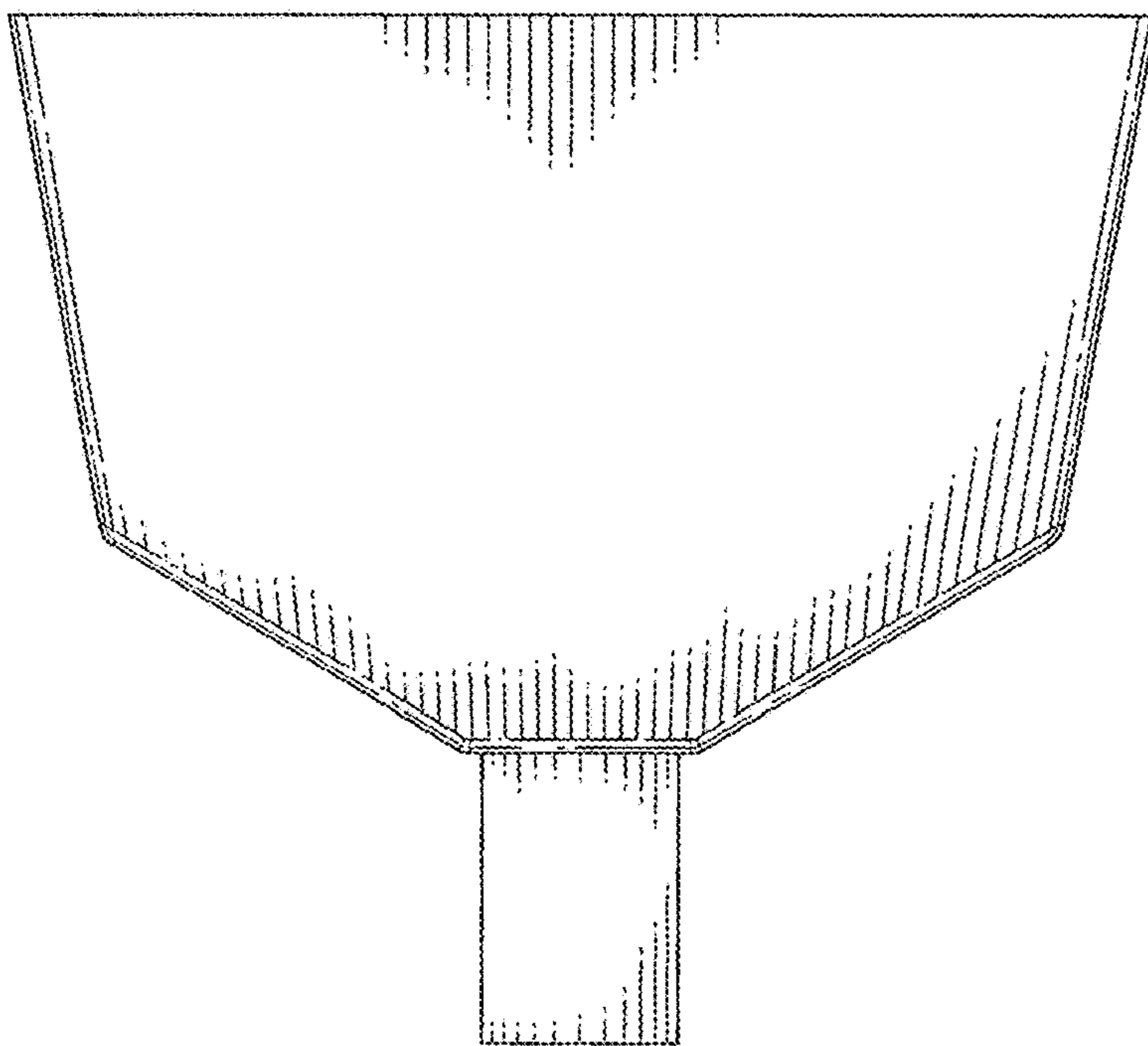

FIG. 12

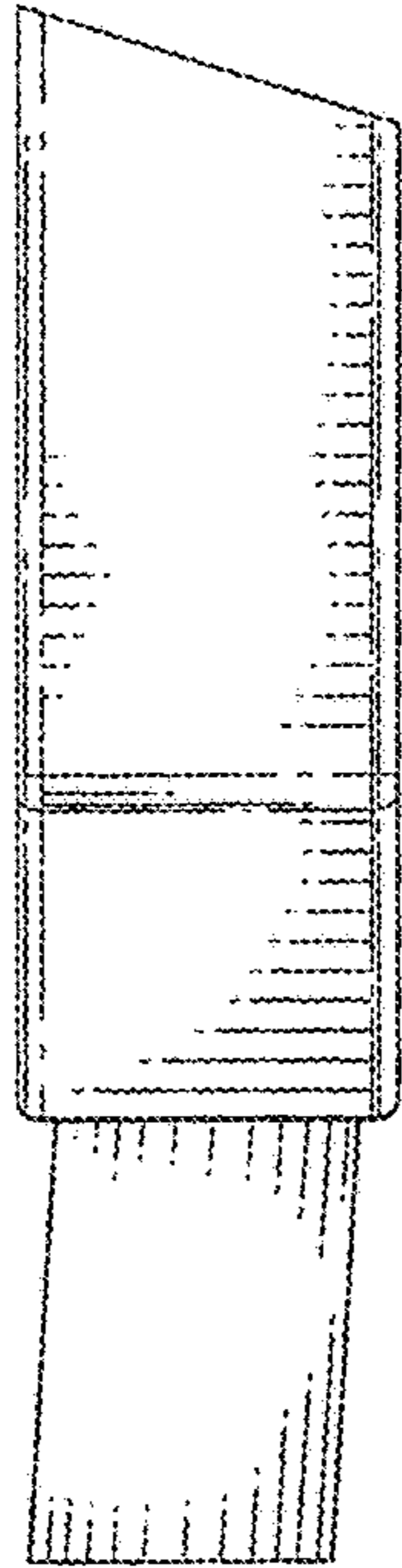

FIG. 13

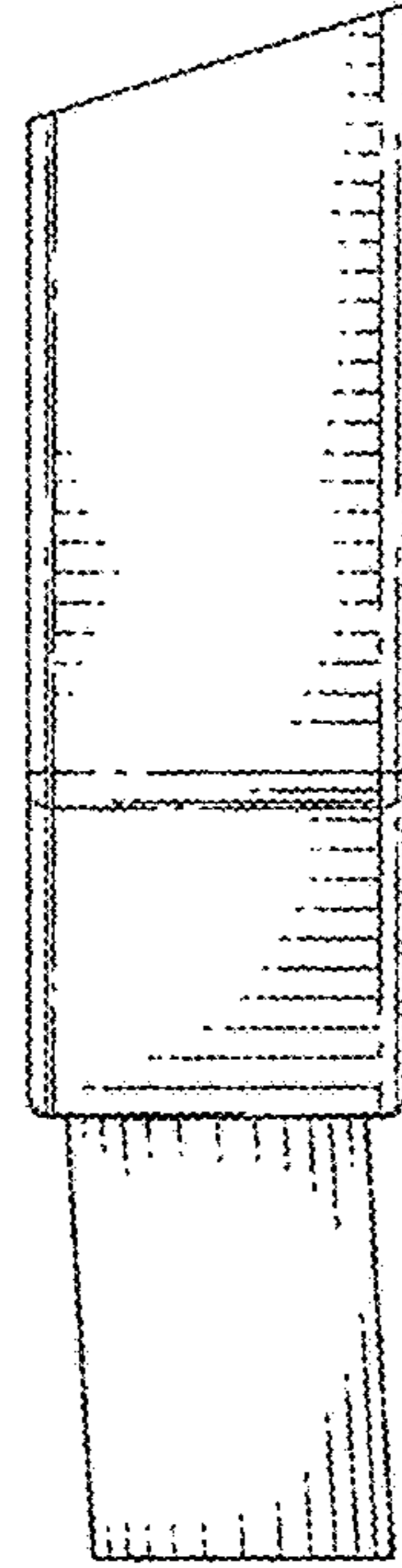

FIG. 14

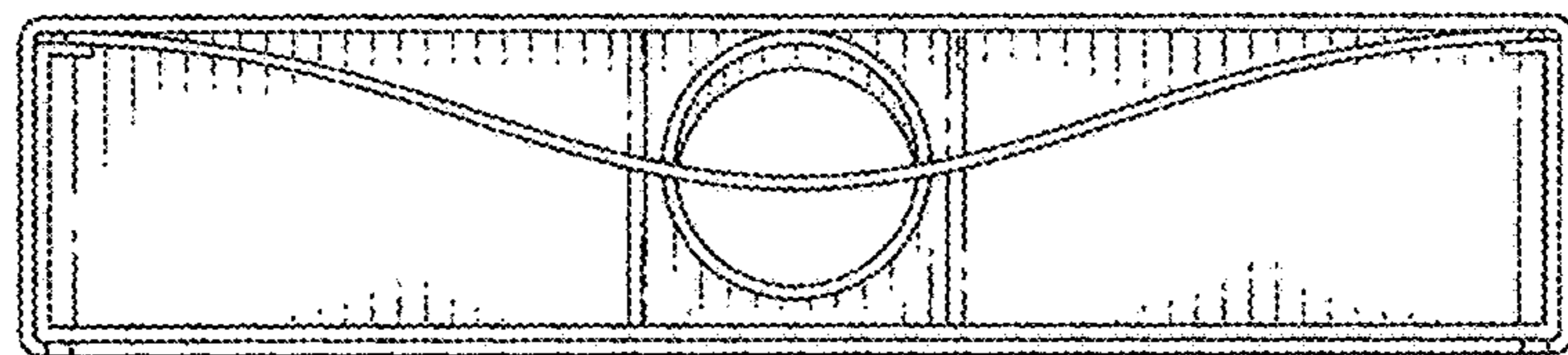

FIG. 15

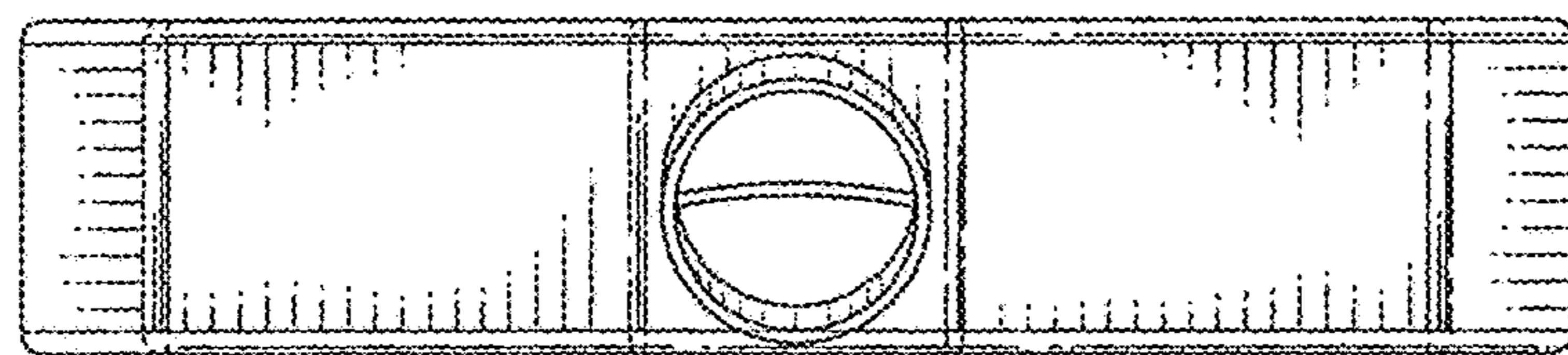

FIG. 16