



US00D863751S

(12) **United States Design Patent**
Seamarks

(10) **Patent No.:** **US D863,751 S**
(45) **Date of Patent:** **** Oct. 22, 2019**

- (54) **SHOE**
- (71) Applicant: **NIKE, Inc.**, Beaverton, OR (US)
- (72) Inventor: **Karl Seamarks**, Portland, OR (US)
- (73) Assignee: **NIKE, Inc.**, Beaverton, OR (US)
- (**) Term: **15 Years**
- (21) Appl. No.: **29/676,325**
- (22) Filed: **Jan. 10, 2019**
- (51) **LOC (12) Cl.** **02-99**
- (52) **U.S. Cl.**
USPC **D2/972**
- (58) **Field of Classification Search**
USPC D2/896, 902, 905, 907, 915, 946, 947,
D2/964, 968, 972, 976, 977, 951, 953
CPC A43B 5/00; A43B 5/001; A43B 5/002;
A43B 5/003; A43B 5/007; A43B 5/008;
A43B 5/02; A43B 5/06; A43B 5/10;
A43B 5/14; A43B 13/00; A43B 13/02;
A43B 13/04; A43B 13/14; A43B 21/00;
A43B 21/02; A43B 21/04; A43B 21/06;
A43B 21/08; A43B 21/18; A43B 21/20;
A43B 21/24; A43B 21/54
See application file for complete search history.

- D566,960 S * 4/2008 Rivas D2/964
- 7,546,695 B2 * 6/2009 Aveni A43B 7/1495
36/114
- D661,878 S 6/2012 Grenet
- D783,258 S * 4/2017 Shyllon D2/972
- D783,960 S 4/2017 Hatfield
- D786,545 S 5/2017 Link
- D789,052 S 6/2017 Hardman
- D790,170 S 6/2017 Rasmussen
- D794,287 S 8/2017 Raasch
- D798,556 S * 10/2017 Sullivan D2/947
- D799,179 S 10/2017 Comeaux
- D805,753 S 12/2017 Enayah

(Continued)

OTHER PUBLICATIONS

Nike Footwear Catalog, 1986 Spring Footwear, p. 3, published Jun. 1985, NIKE, Inc., USA.

(Continued)

Primary Examiner — Elizabeth J Oswecki
(74) *Attorney, Agent, or Firm* — Banner & Witcoff, Ltd.

(57) **CLAIM**

The ornamental design for a shoe, as shown and described.

(56) **References Cited**

U.S. PATENT DOCUMENTS

- D260,196 S 8/1981 Plagenhoef
- D319,720 S 9/1991 Selbiger
- D321,584 S 11/1991 Mitsui
- D375,190 S 11/1996 Lucas
- D407,540 S 4/1999 Dolinsky
- D411,242 S 6/1999 Link
- D419,284 S 1/2000 Dolinsky
- D511,618 S * 11/2005 McDowell D2/964
- D516,786 S * 3/2006 Besanceney, III D2/947
- D541,052 S * 4/2007 Miller D5/53
- D554,842 S * 11/2007 Gaenssler A43B 1/0009
D2/946

DESCRIPTION

FIG. 1 is a side view of a shoe showing my new design; FIG. 2 is a rear perspective view thereof; FIG. 3 is a rear view thereof; FIG. 4 is a second rear perspective view thereof; and, FIG. 5 is an opposite side view thereof. The broken lines immediately adjacent to the shaded area define the bounds of the claimed design and form no part thereof. The broken lines depicting the remainder of the shoe show features that form no part of the claimed design.

1 Claim, 5 Drawing Sheets

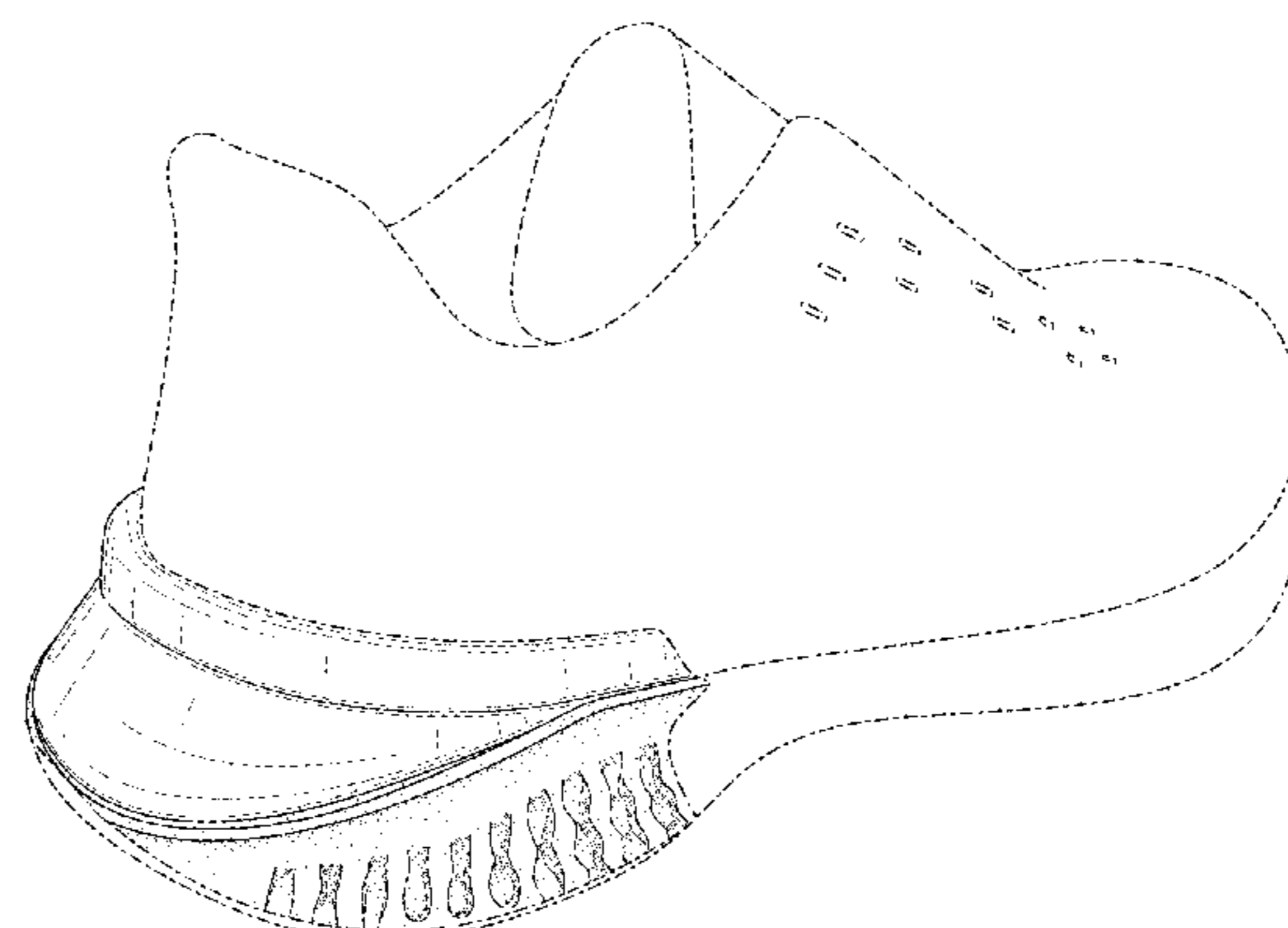
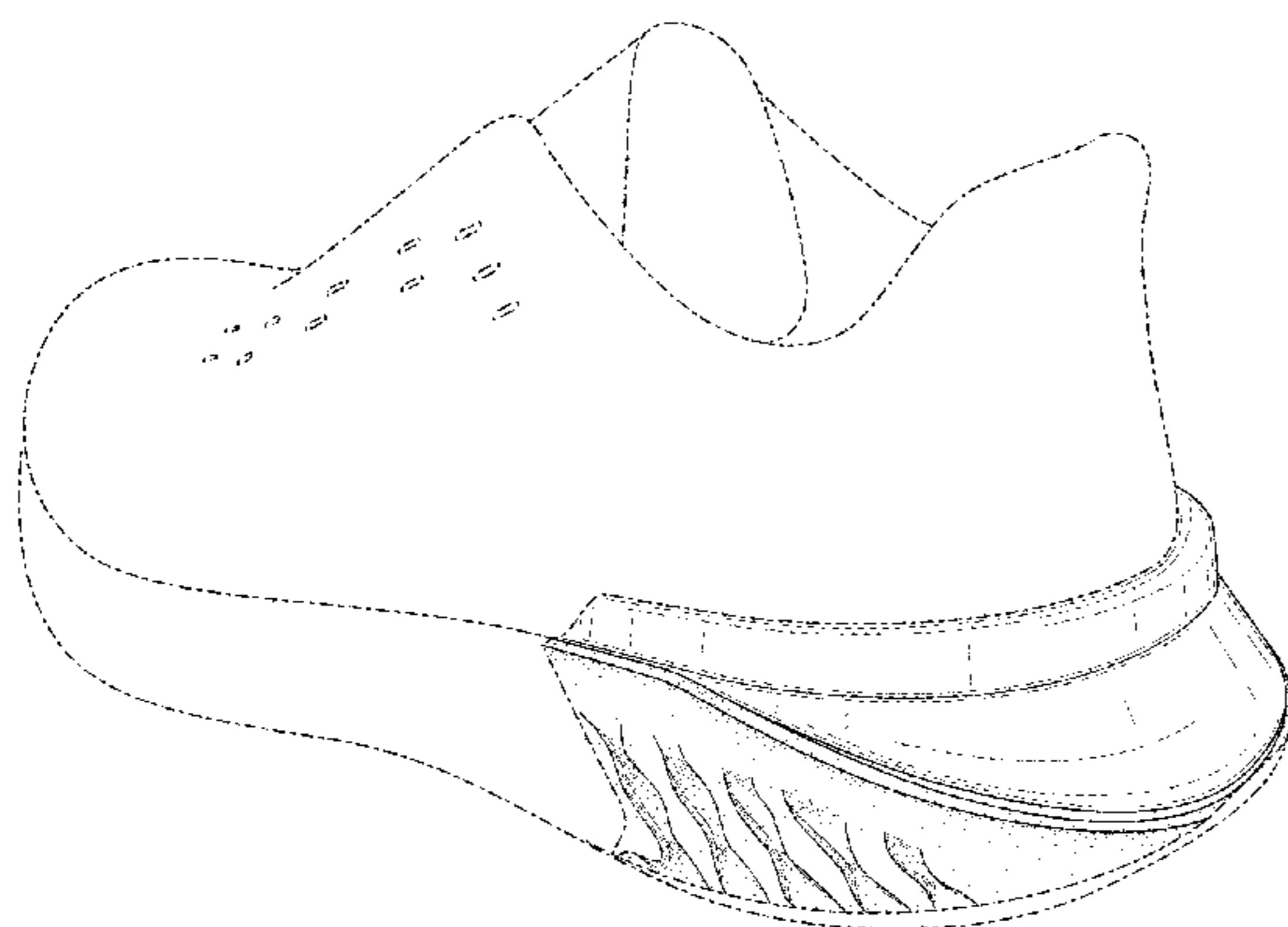

(56)

References Cited

U.S. PATENT DOCUMENTS

D808,629 S	1/2018	Parrett et al.	
D816,956 S *	5/2018	Sokol	D2/947
D816,972 S	5/2018	Pauk	
D817,611 S	5/2018	Small	
D817,612 S	5/2018	Small	
D817,628 S	5/2018	Hatfield	
D819,310 S	6/2018	Lashmore	
D819,312 S	6/2018	Lashmore et al.	
D822,349 S	7/2018	Petrenka	
D829,420 S	10/2018	McWee	
D829,421 S	10/2018	Pope	
D829,423 S	10/2018	Robusti	
D834,796 S	12/2018	Pope	
D834,797 S	12/2018	Rathbum	
D834,799 S	12/2018	Rathbum	
D835,389 S	12/2018	Durflinger	
D838,966 S	1/2019	Pauk	
D839,565 S *	2/2019	Petrie	D2/947
D840,554 S *	2/2019	Mendes Silva Castro ..	D25/163
D841,297 S	2/2019	Small	
D841,298 S *	2/2019	Small	D2/947
D844,954 S *	4/2019	Sokol	D2/947
D851,877 S *	6/2019	Small	D2/947
D854,795 S *	7/2019	Hatfield	D2/947

OTHER PUBLICATIONS

Nike Footwear Catalog, 1987 Fall Footwear, p. 14, published Jan. 1987, NIKE, Inc., USA.
 Nike Footwear Catalog, 1988 Fall Footwear, p. 38, published Dec. 1987, NIKE, Inc., USA.
 Nike Footwear Catalog, 1993 Holiday Footwear, p. 4, published Mar. 1993, NIKE, Inc., USA.

Nike Footwear Catalog, 1994 Spring Footwear, p. 38, published Jun. 1993, NIKE, Inc., USA.
 Nike Footwear Catalog, 1994 Fall Footwear, p. 52, published Nov. 1993, NIKE, Inc., USA.
 Nike Footwear Catalog, 1997 Spring Footwear, p. 40, published Jun. 1996, NIKE, Inc., USA.
 Nike Footwear Catalog, 1997 Fall Footwear, p. 28, published Dec. 1996, NIKE, Inc., USA.
 Nike Footwear Catalog, 1999 Fall Footwear, p. M66, published Nov. 1998, NIKE, Inc., USA.
 Nike Footwear Catalog, 2009 Spring Sport Performance Footwear, p. 57, published May 2008, NIKE, Inc., USA.
 Nike Footwear Catalog, 2009 Fall Core Footwear, p. 2, published Nov. 2008, NIKE, Inc., USA.
 Nike Footwear Catalog, 2015 Spring Core Performance Footwear Final, p. 11, published May 14, 2014, NIKE, Inc., USA.
 Nike Footwear Catalog, 2016 Fall Strategic Sporting Goods Apparel Equipment Catalog NA, p. 125, published Nov. 2015, NIKE, Inc., USA.
 Nike Footwear Catalog, 2018 Summer Running, p. 61, published date unknown, but prior to the filing date of the present application, NIKE, Inc., USA.
 Nike Footwear Catalog, 2019 Spring Running, p. 96, published date unknown, but prior to the filing date of the present application, NIKE, Inc., USA.
 Nike Footwear Catalog, 2016 Fall Lacrosse Specialty Footwear Apparel Equipment NA, p. 21, published Nov. 2015, NIKE, Inc., USA.
 “Nike Epic React Coming Soon in White and Pink”; Sneaker News ; retrieved May 16, 2019; published Apr. 25, 2018; URL: <<https://sneakernews.com/2018/04/25/nike-epic-react-white-pink-release-info/>>.
 “Nike Odyssey React 2 Flyknit”; Running Shoes Guru; retrieved May 16, 2019; published Apr. 8, 2019; URL: <<https://www.runningshoesguru.com/2019/04/nike-odyssey-react-2-flyknit/>>.

* cited by examiner

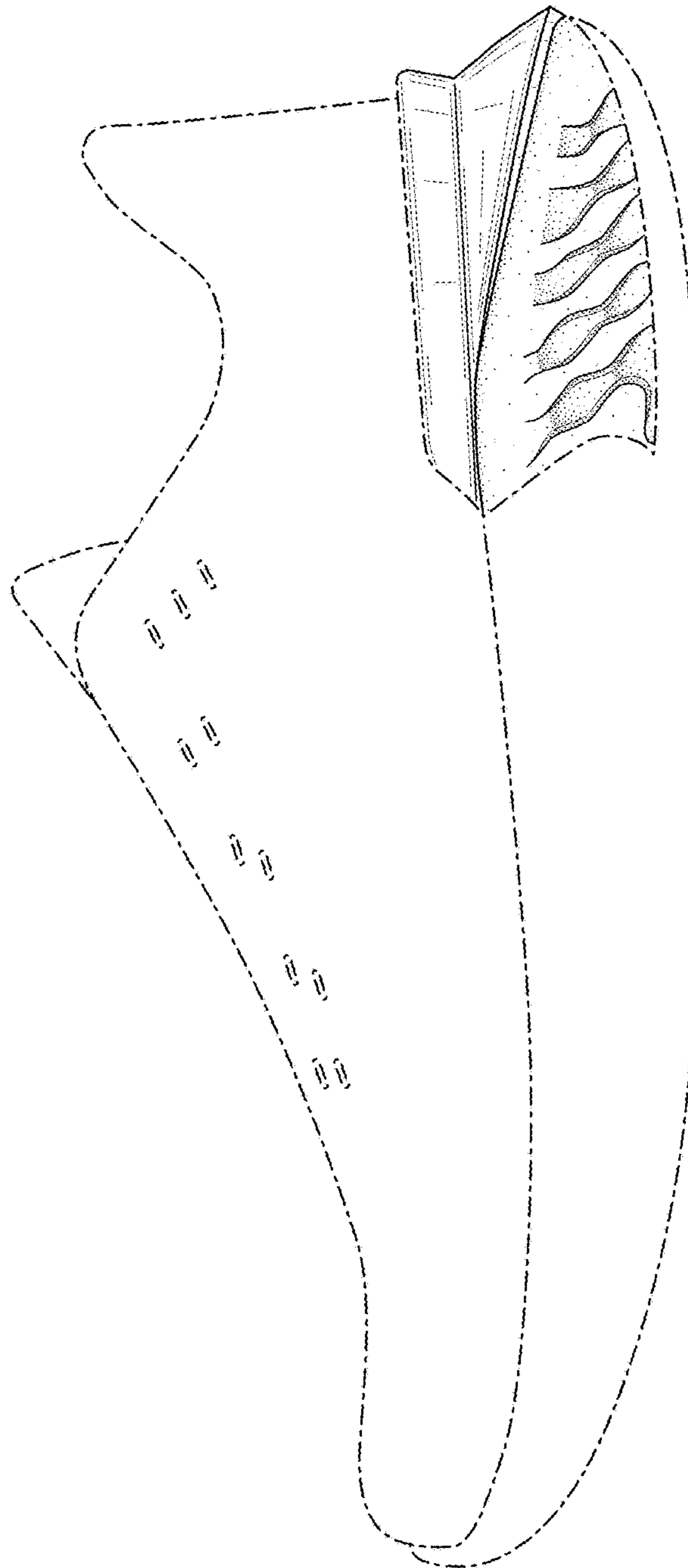

FIG. 1

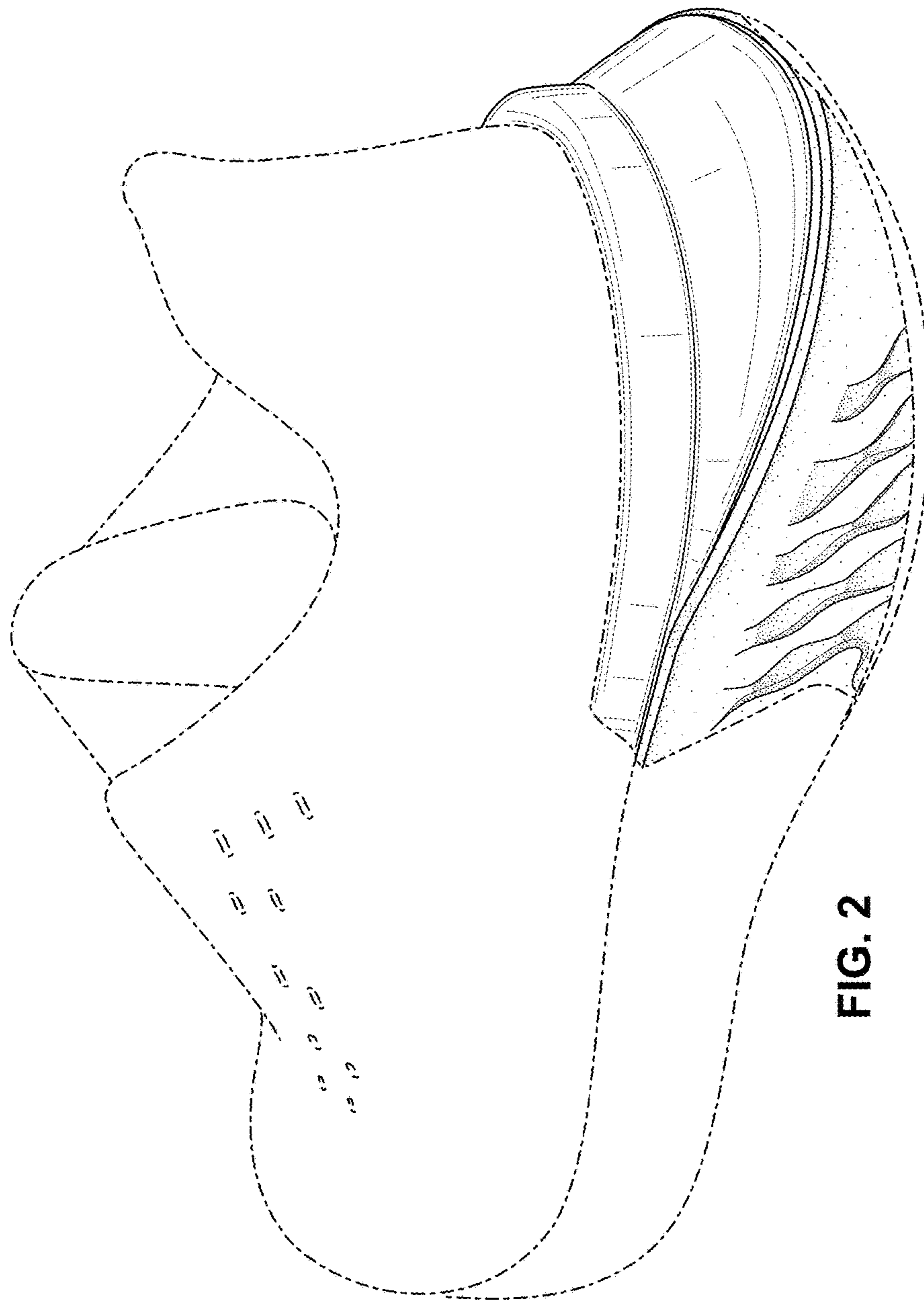

FIG. 2

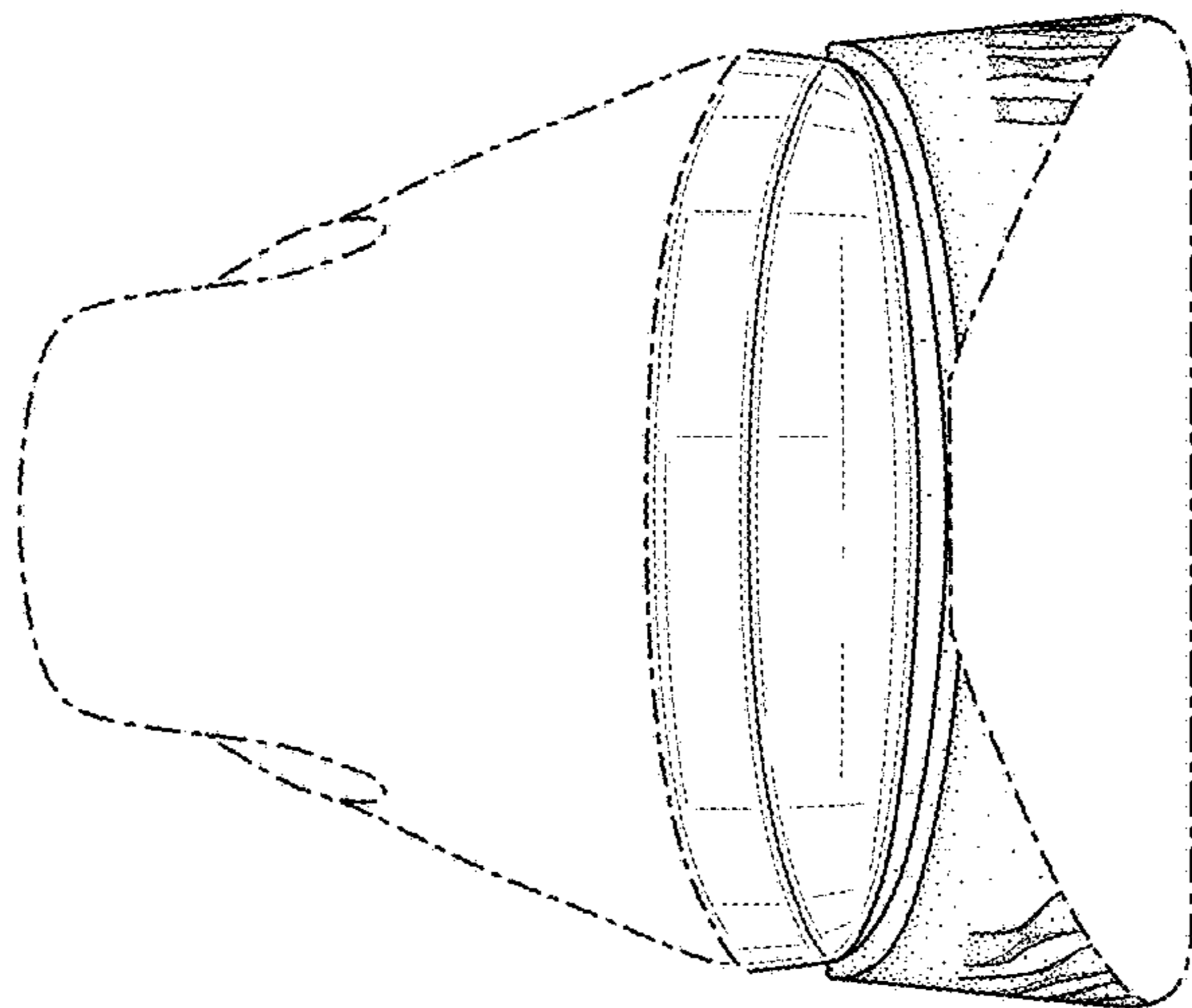

FIG. 3

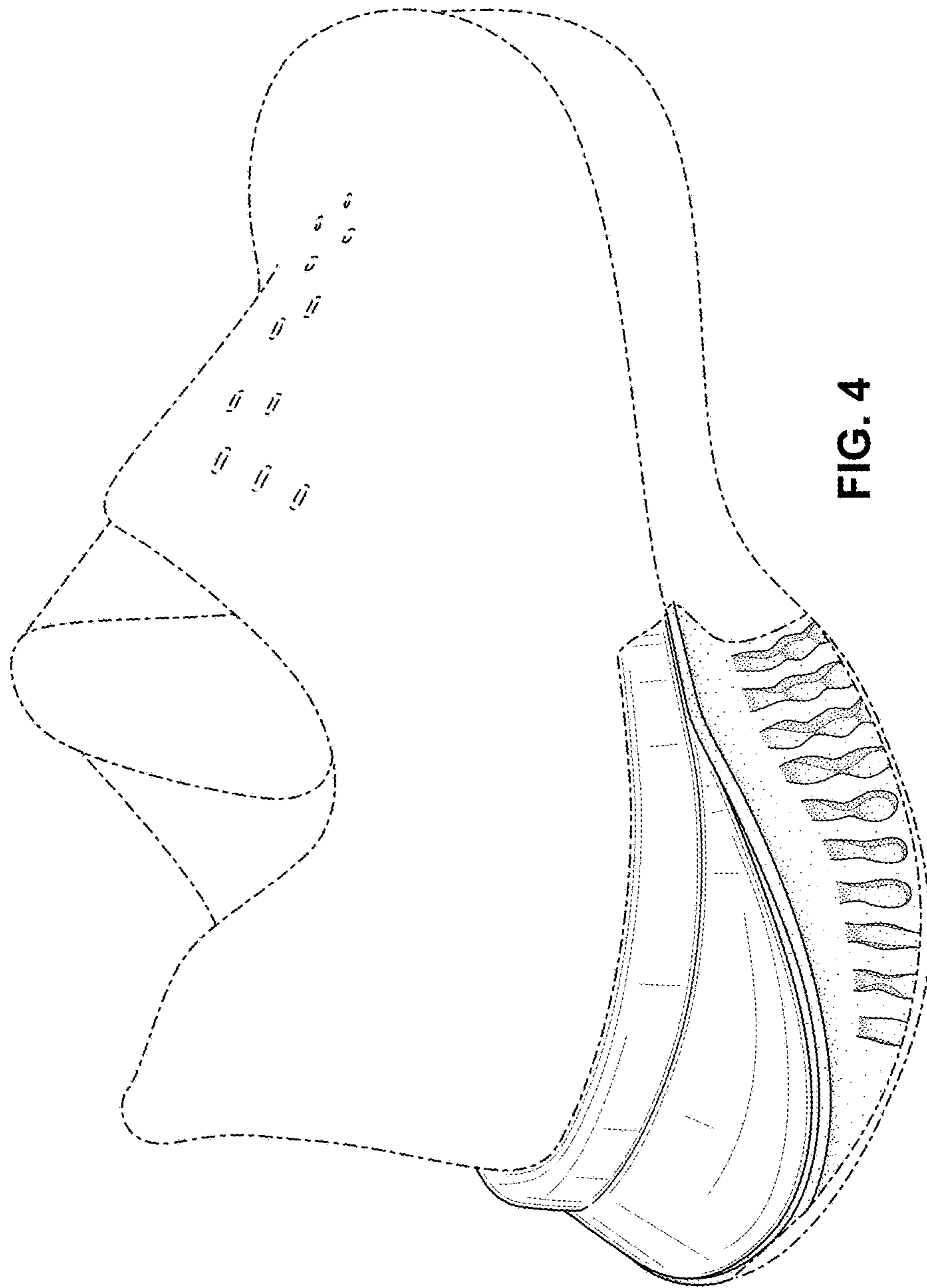

FIG. 4

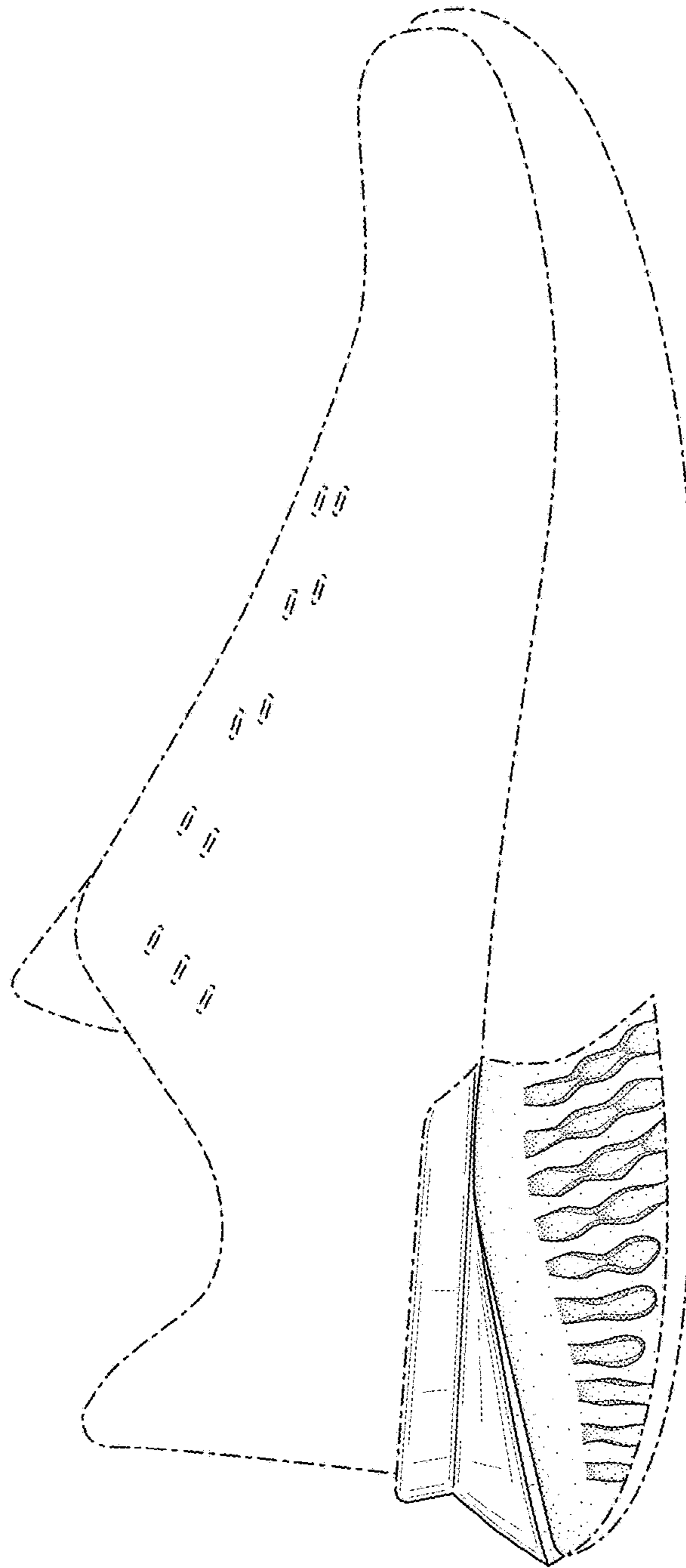

FIG. 5