



US00D863673S

(12) **United States Design Patent** (10) **Patent No.:** **US D863,673 S**
Lai (45) **Date of Patent:** **** Oct. 15, 2019**

(54) **ELECTRONIC CIGARETTE**
(71) Applicant: **Shenzhen Smoore Technology Limited**, Shenzhen, Guangdong (CN)
(72) Inventor: **Baosheng Lai**, Guangdong (CN)
(73) Assignee: **SHENZHEN SMOORE TECHNOLOGY LIMITED**, Shenzhen (CN)

D768,331 S * 10/2016 Chen D27/101
D770,678 S * 11/2016 Shin D27/163
D772,477 S * 11/2016 Shin D27/163
9,888,715 B2 * 2/2018 Li A24F 15/20
D814,019 S * 3/2018 Crosby D24/110
D820,514 S * 6/2018 Durand D27/162
D821,640 S * 6/2018 Qiu D27/162
D823,536 S * 7/2018 Lai D27/163
D828,953 S * 9/2018 Chen D27/167
D834,746 S * 11/2018 Liu D27/162
D839,407 S * 1/2019 Rudolph D24/110
D846,796 S * 4/2019 Pan D27/101

(**) Term: **15 Years**
(21) Appl. No.: **29/646,881**
(22) Filed: **May 8, 2018**

* cited by examiner
Primary Examiner — Susan Bennett Hattan
Assistant Examiner — Rebecca Tsehaye

(30) **Foreign Application Priority Data**
Nov. 8, 2017 (CN) 2017 3 0547221
(51) **LOC (12) Cl.** **27-02**
(52) **U.S. Cl.**
USPC **D27/162**
(58) **Field of Classification Search**
USPC D27/162, 101, 106, 108, 139–142, 153,
D27/157–161, 163–167, 169–175, 183,
D27/186–190, 193, 195; D24/110;
131/273, 274, 191, 330, 329, 328
CPC A24F 9/00; A24F 47/002; A24F 47/004;
A24F 47/006; A24F 47/008; A61M 15/06
See application file for complete search history.

(57) **CLAIM**
The ornamental design for an electronic cigarette, as shown and described.

(56) **References Cited**
U.S. PATENT DOCUMENTS
D723,738 S * 3/2015 Liu D27/189
D736,460 S * 8/2015 McKeon D27/189

DESCRIPTION
FIG. 1 is a top, front and right side perspective view of an electronic cigarette showing my new design;
FIG. 2 is a bottom, rear and left side perspective view thereof;
FIG. 3 is a front elevational view thereof;
FIG. 4 is a rear elevational view thereof;
FIG. 5 is a left side view thereof;
FIG. 6 is a right side view thereof;
FIG. 7 is a bottom plan view thereof; and,
FIG. 8 is a top plan view thereof.
The broken lines in the drawings illustrate portions of the electronic cigarette which form no part of the claimed design.

1 Claim, 8 Drawing Sheets

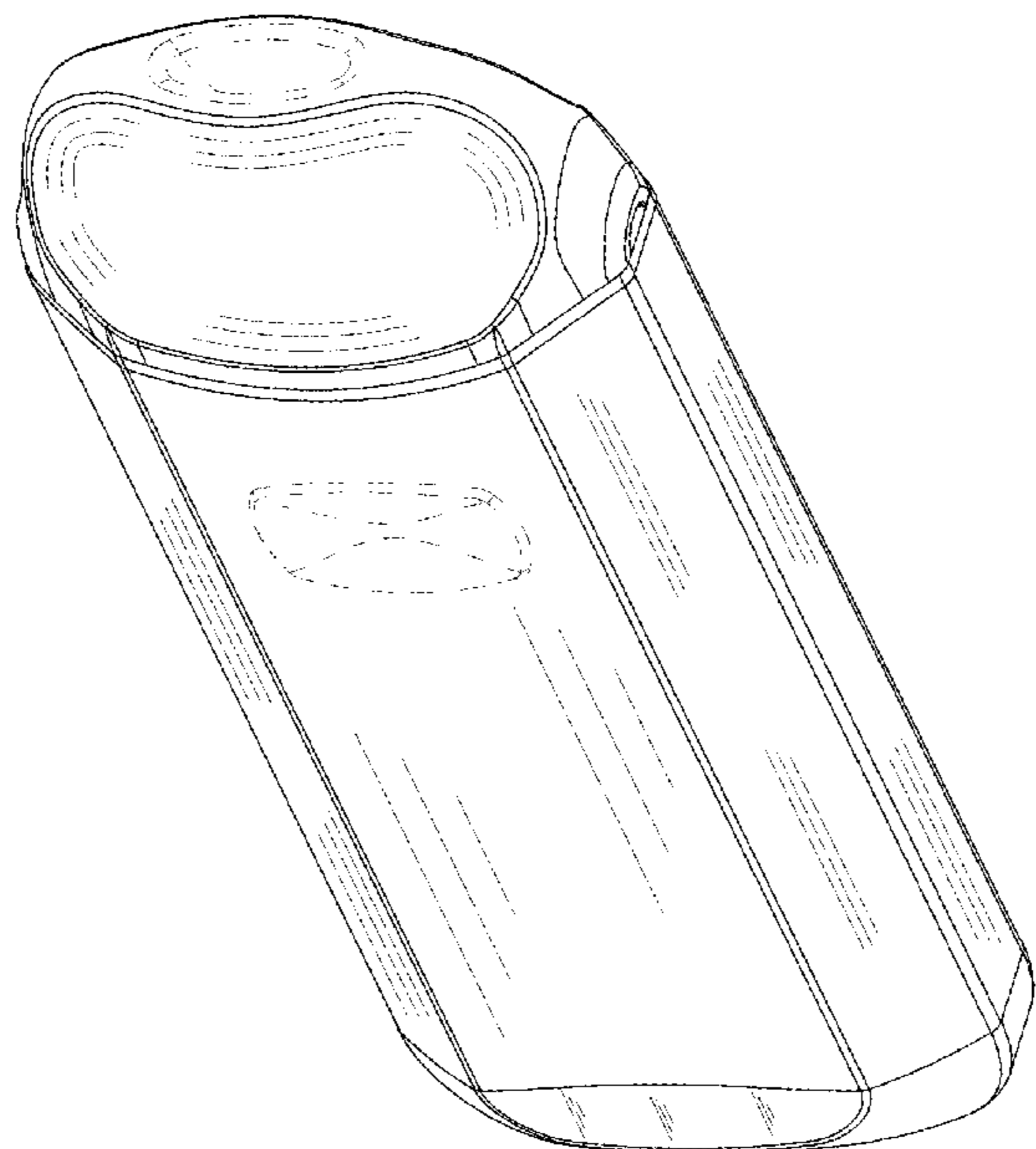

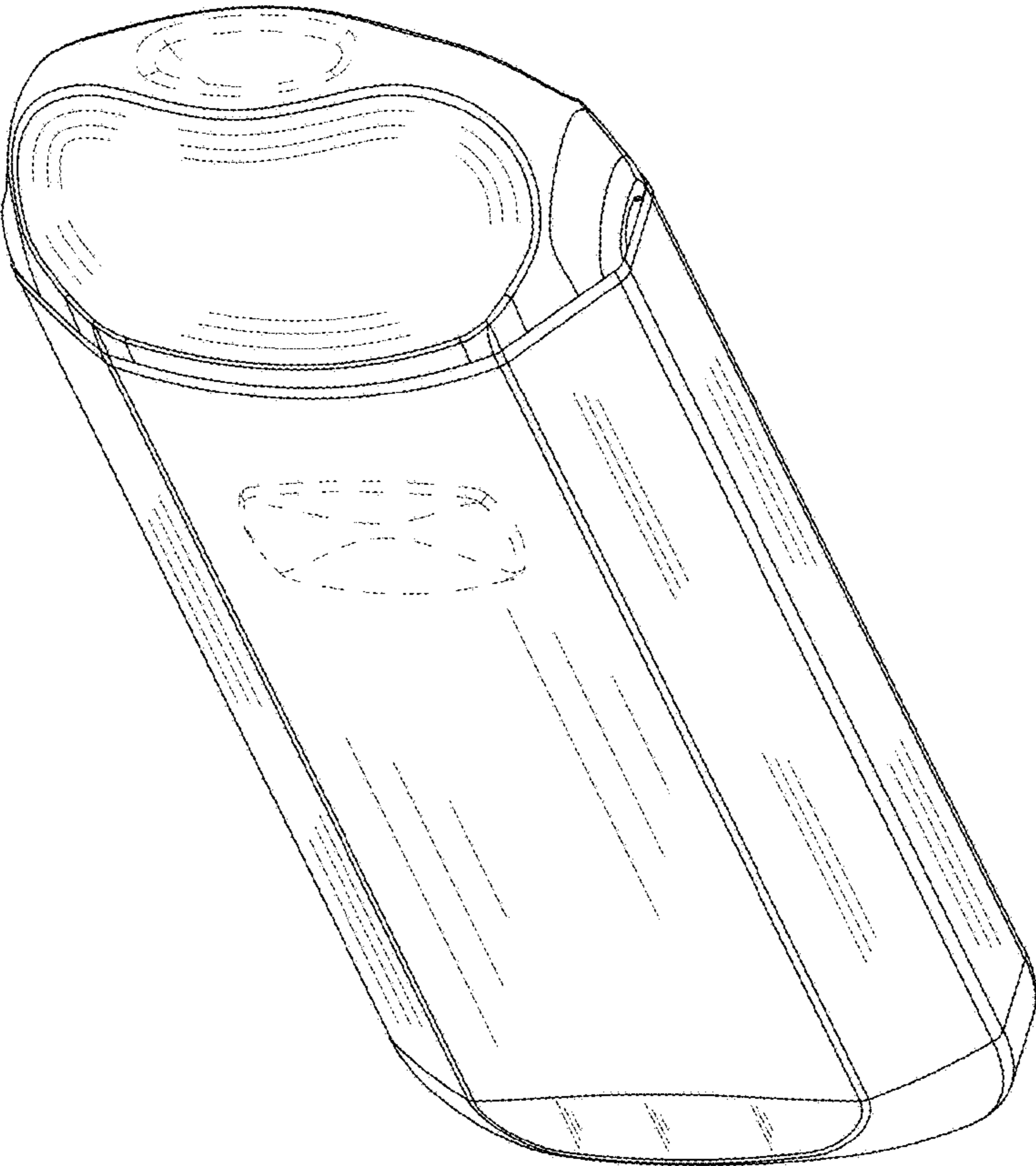

FIG.1

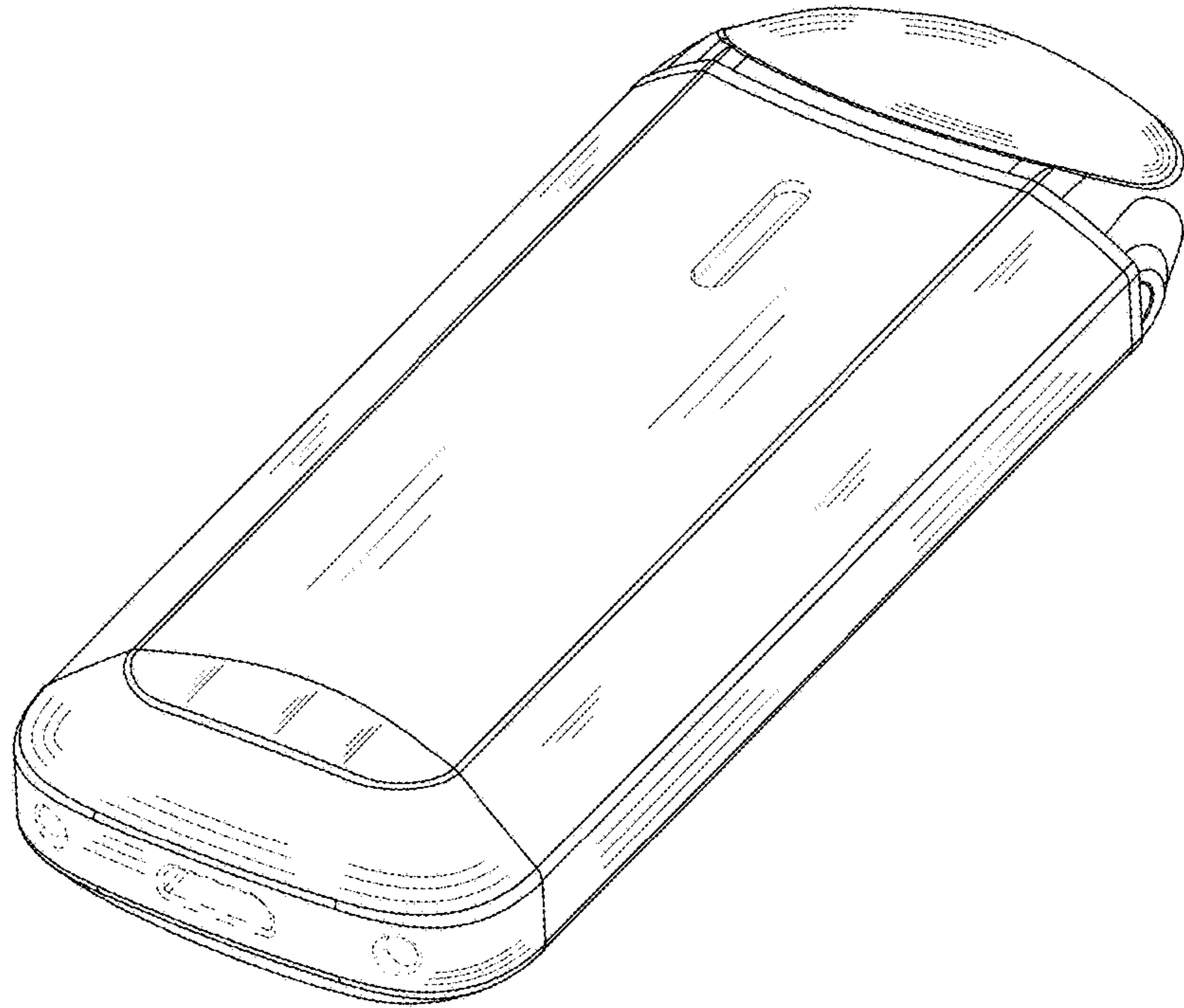

FIG.2

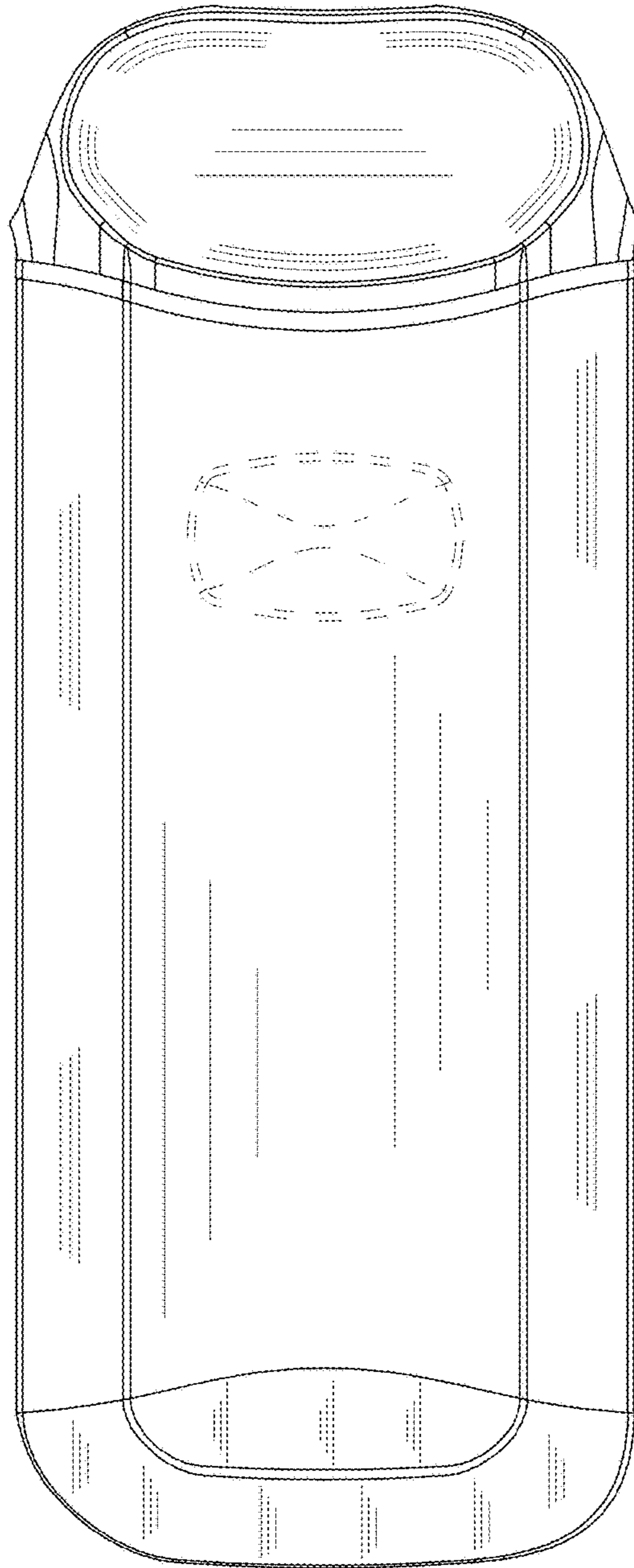

FIG.3

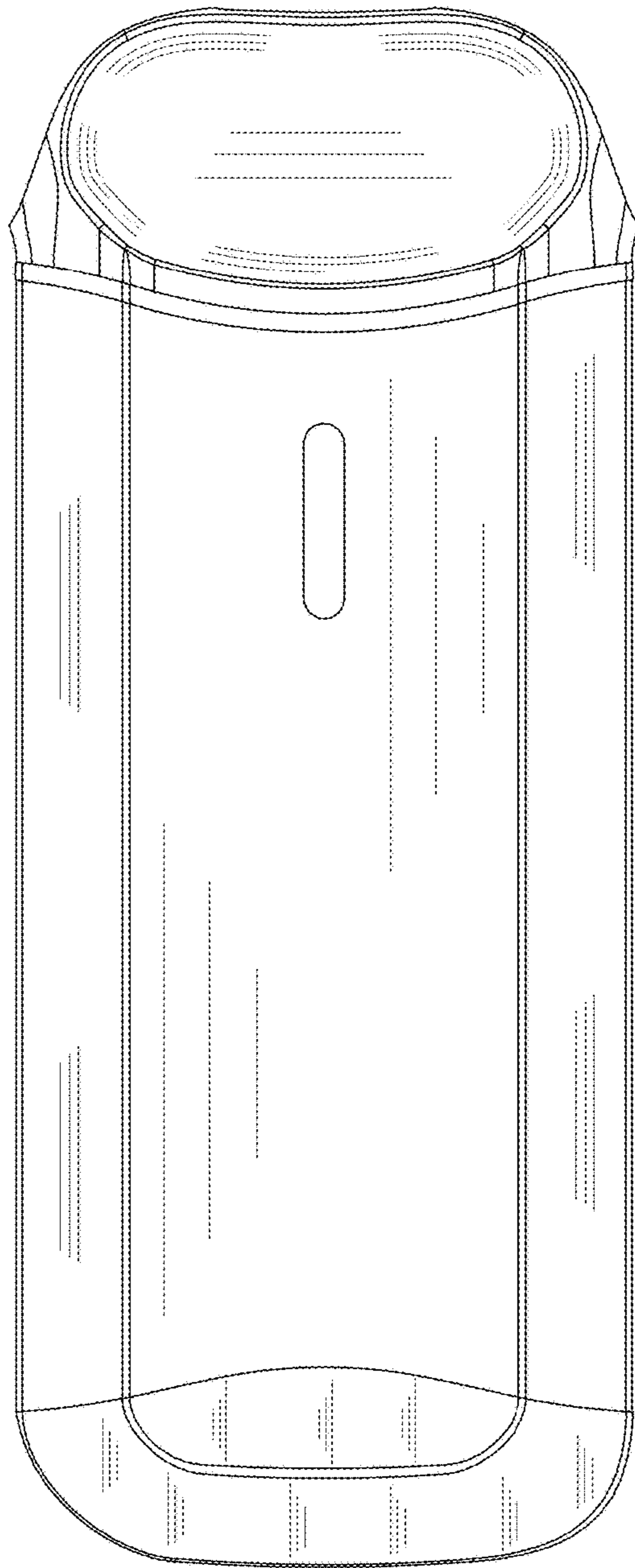

FIG.4

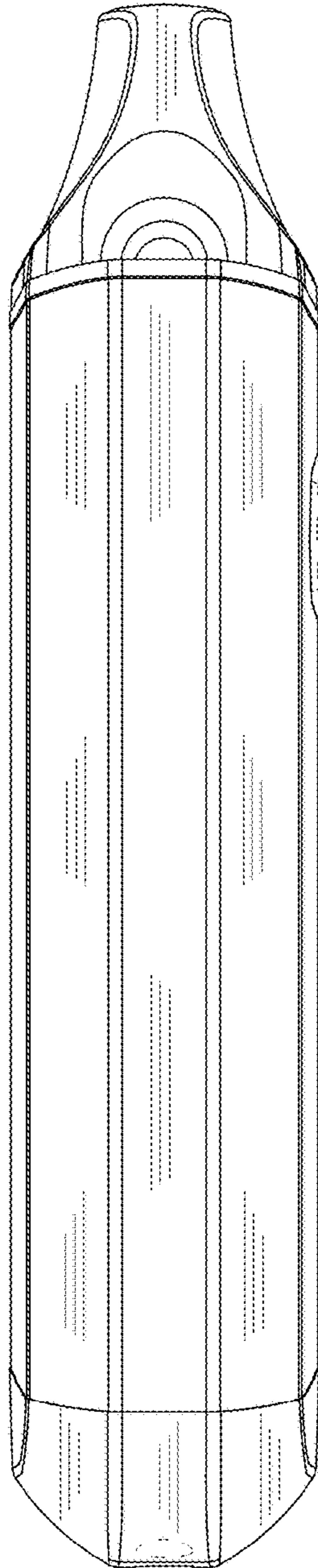

FIG.5

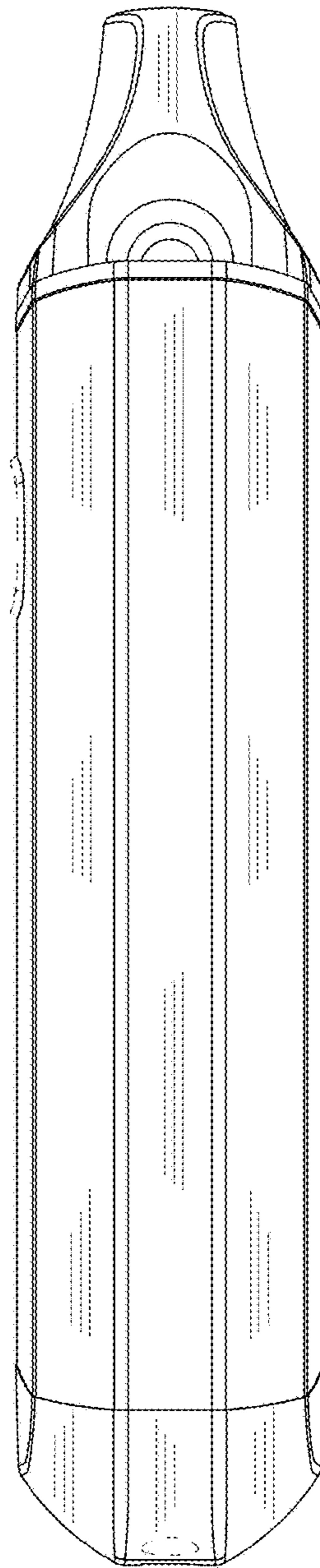

FIG.6

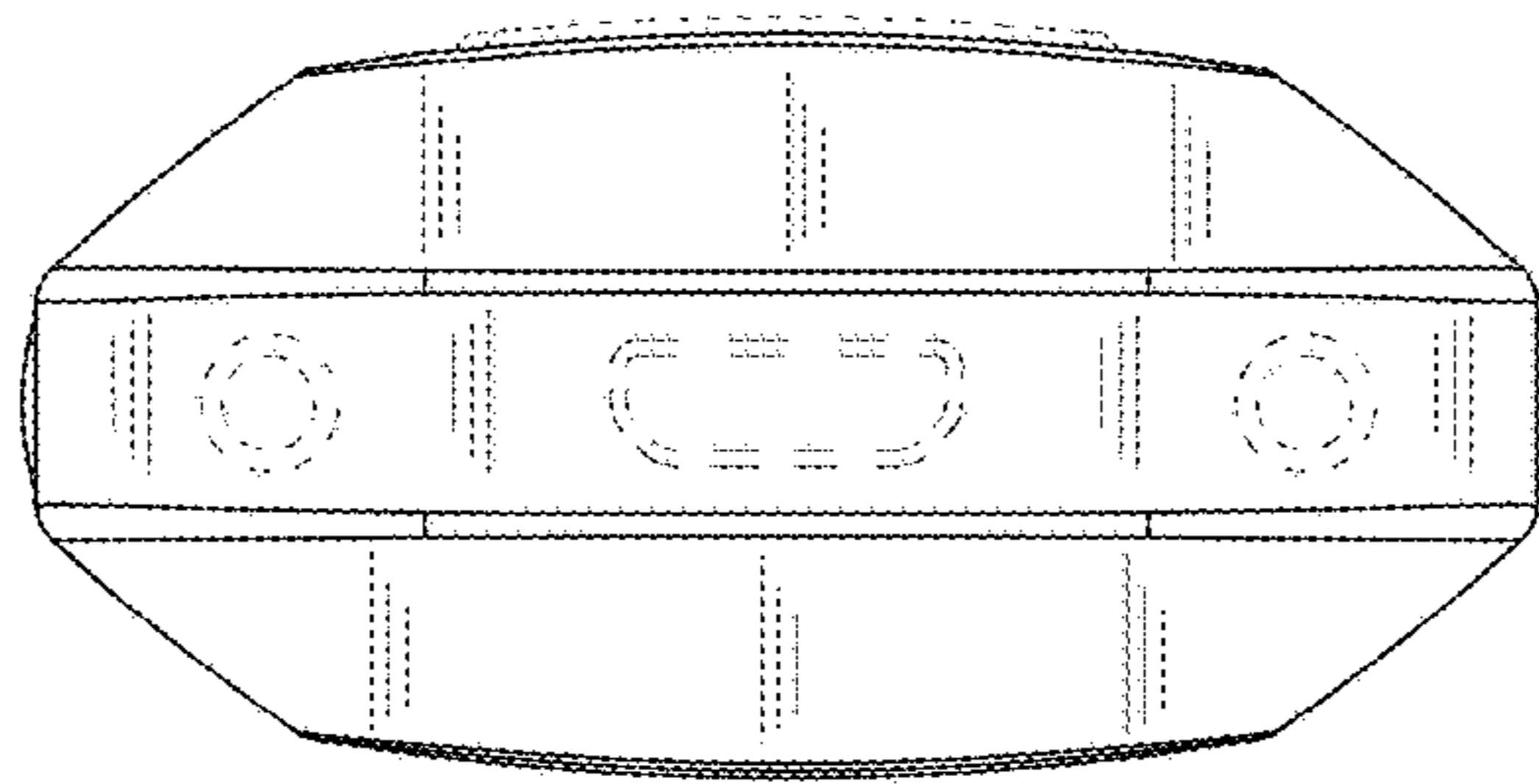

FIG. 7

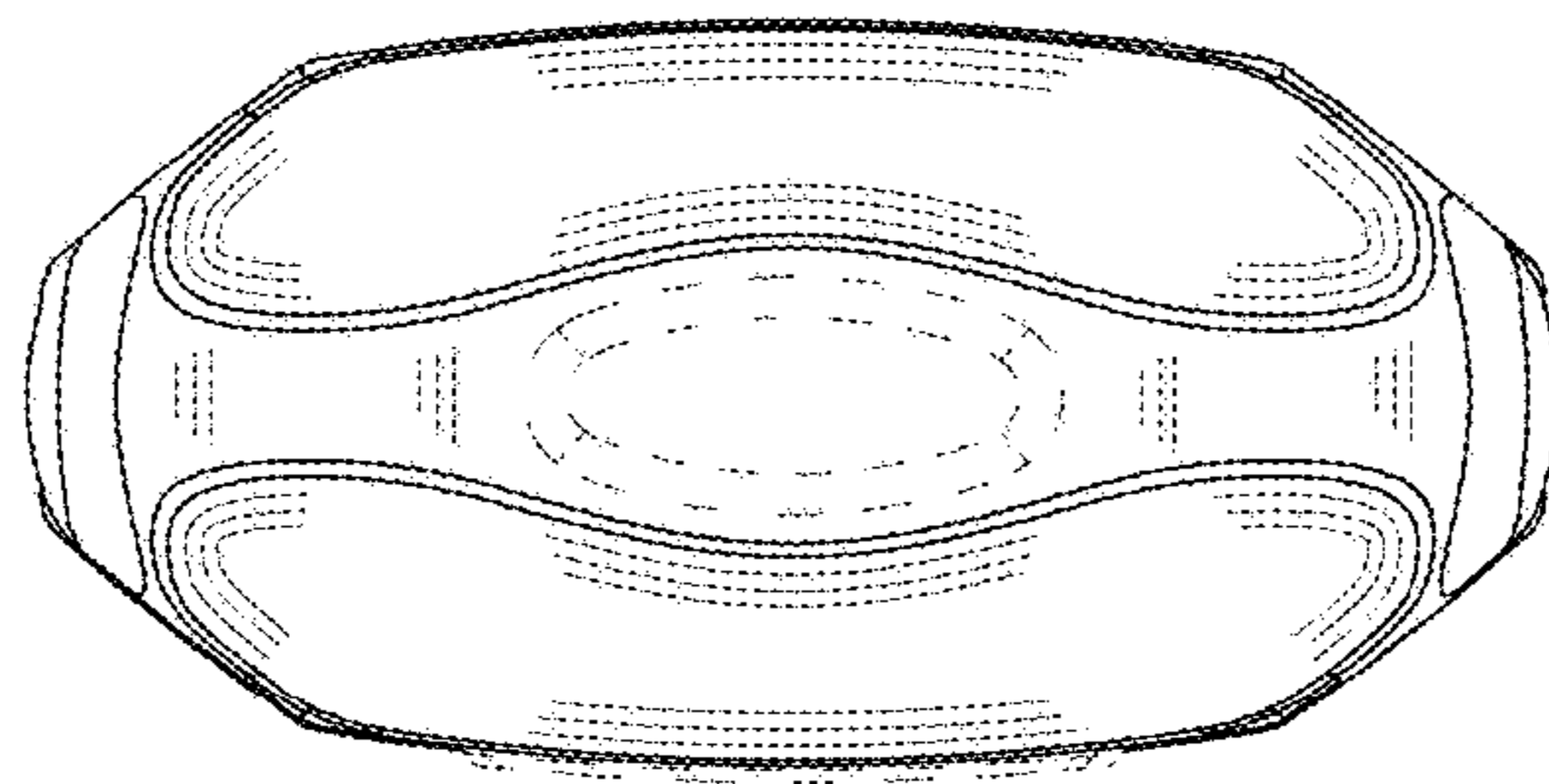

FIG.8