



US00D863581S

(12) **United States Design Patent**
Lee

(10) **Patent No.:** **US D863,581 S**
(45) **Date of Patent:** **** Oct. 15, 2019**

(54) **SKIN CARE BEAUTY DEVICE**

(71) Applicant: **Jin Hee Lee**, Seoul (KR)

(72) Inventor: **Jin Hee Lee**, Seoul (KR)

(**) Term: **15 Years**

(21) Appl. No.: **29/664,512**

(22) Filed: **Sep. 26, 2018**

(30) **Foreign Application Priority Data**

Apr. 6, 2018 (KR) 30-2018-0016259

(51) **LOC (12) Cl.** **28-03**

(52) **U.S. Cl.**
USPC **D24/211**

(58) **Field of Classification Search**
USPC 601/19, 22, 40, 46, 52, 63, 99, 110–113,
601/118–120, 125, DIG. 12,
601/DIG. 14–DIG. 17; D24/133, 147,
D24/200, 211, 212, 213, 214, 215;
D28/58; D4/122
CPC A61H 15/0092; A61H 2015/0014; A61H
15/00; A61H 7/001
See application file for complete search history.

(56) **References Cited**

U.S. PATENT DOCUMENTS

D349,576 S *	8/1994	Heiligenstein	D24/200
D445,508 S *	7/2001	Gladieux, III	D24/211
D469,879 S *	2/2003	Chen	D24/211
D549,834 S *	8/2007	Huang	D24/211
D582,048 S *	12/2008	Chiu	D24/200
D609,817 S *	2/2010	Piller	D24/215
D637,309 S *	5/2011	Park	D24/215
D676,975 S *	2/2013	Bickford	D24/211
D677,391 S *	3/2013	Bickford	D24/211
D677,392 S *	3/2013	Bickford	D24/211
D678,540 S *	3/2013	Bickford	D24/211

D678,541 S *	3/2013	Bickford	D24/211
D678,542 S *	3/2013	Bickford	D24/211
D692,570 S *	10/2013	Luzon	D24/215
D706,981 S *	6/2014	Clough	D28/44.1
D706,982 S *	6/2014	Clough	A45D 26/00 D28/44.1
D726,926 S *	4/2015	Matsushita	D24/200
D726,927 S *	4/2015	Matsushita	D24/200
D752,812 S *	3/2016	Sivan	D28/58
D780,933 S *	3/2017	Uchida	D24/200
D781,498 S *	3/2017	Pel	D24/133
D781,499 S *	3/2017	Pel	D24/133
D794,197 S *	8/2017	Powell	D24/130
D820,522 S *	6/2018	Colin	D28/58
10,004,535 B2 *	6/2018	Khubani	A61B 17/54
D824,596 S *	7/2018	Gobber	A45D 29/00 D28/58
D829,919 S *	10/2018	Davis	D24/211
D841,176 S *	2/2019	Gaquiere	D24/211
D849,259 S *	5/2019	Gaquiere	D24/211
D850,724 S *	6/2019	Luo	D28/58

(Continued)

Primary Examiner — Cynthia Ramirez
Assistant Examiner — Michael A Maharajh
(74) *Attorney, Agent, or Firm* — Kile Park Reed & Houtteman PLLC

(57) **CLAIM**

I claim the ornamental design for a skin care beauty device, as shown and described.

DESCRIPTION

FIG. 1 is a top and front perspective view of a skin care beauty device, showing my new design;
FIG. 2 is a front view thereof;
FIG. 3 is a rear view thereof;
FIG. 4 is a left side view thereof;
FIG. 5 is a right side view thereof;
FIG. 6 is a top view thereof; and,
FIG. 7 is a bottom view thereof.

1 Claim, 5 Drawing Sheets

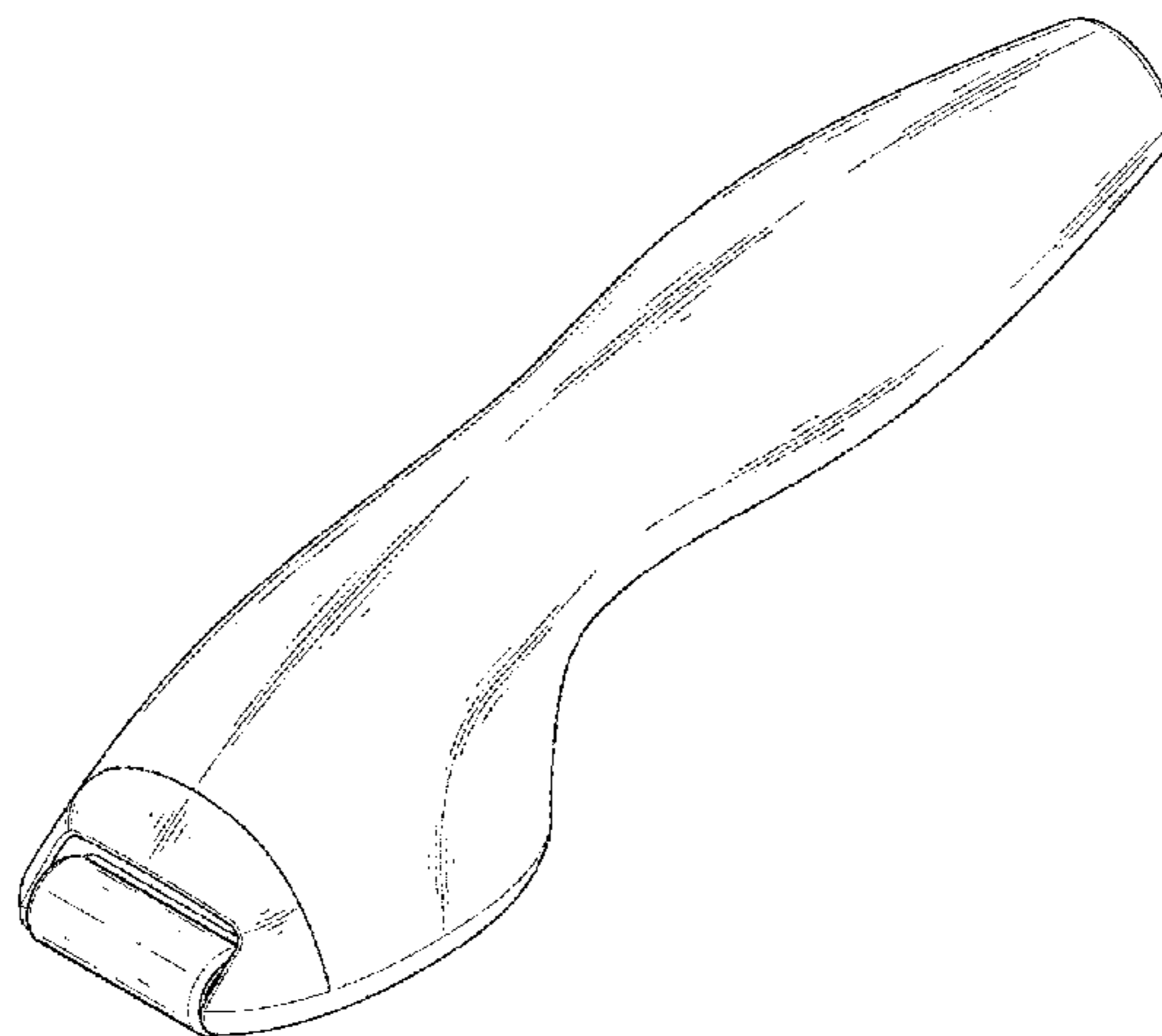

(56)

References Cited

U.S. PATENT DOCUMENTS

2005/0249541 A1* 11/2005 Habatjou A61H 15/0085
401/219
2006/0084894 A1* 4/2006 Anderson A61H 7/006
601/118
2008/0154161 A1* 6/2008 Abbott A61H 15/0092
601/113
2008/0161735 A1* 7/2008 Lee A61H 15/0092
601/125
2009/0312691 A1* 12/2009 Kim A61H 15/0092
604/22
2010/0292723 A1* 11/2010 Lee A61H 15/0092
606/180
2011/0009782 A1* 1/2011 Pampalone A61H 15/0092
601/119
2011/0125067 A1* 5/2011 Filho A61H 15/0092
601/19
2011/0172574 A1* 7/2011 Han A61H 15/0092
601/119
2013/0048011 A1* 2/2013 Bickford A45D 34/041
132/320
2013/0296749 A1* 11/2013 Lin A61H 15/0092
601/119
2015/0374409 A1* 12/2015 Chopdat A61H 7/005
606/131
2017/0049661 A1* 2/2017 Hollinger A61H 15/0085

* cited by examiner

FIG. 1

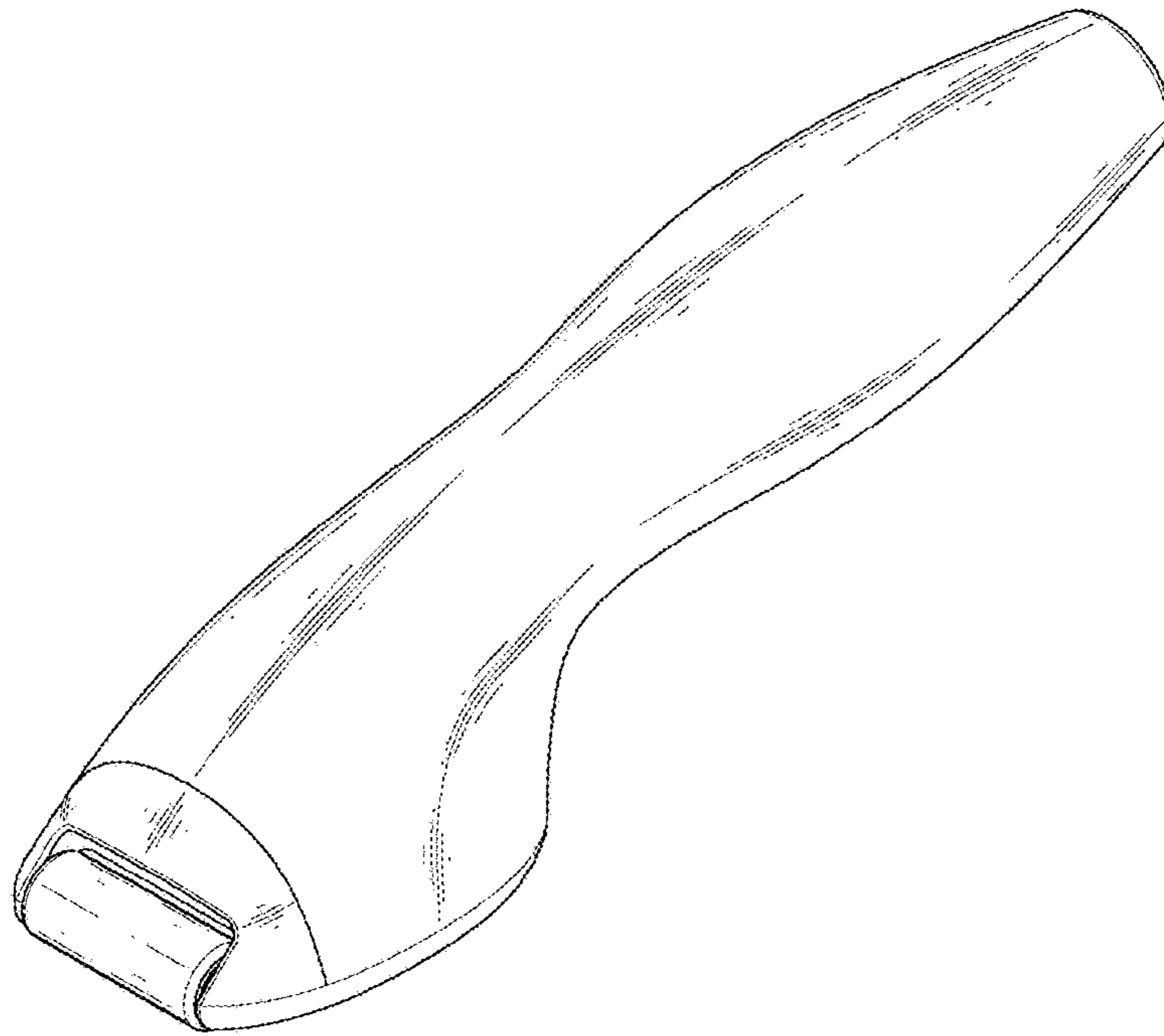

FIG. 2

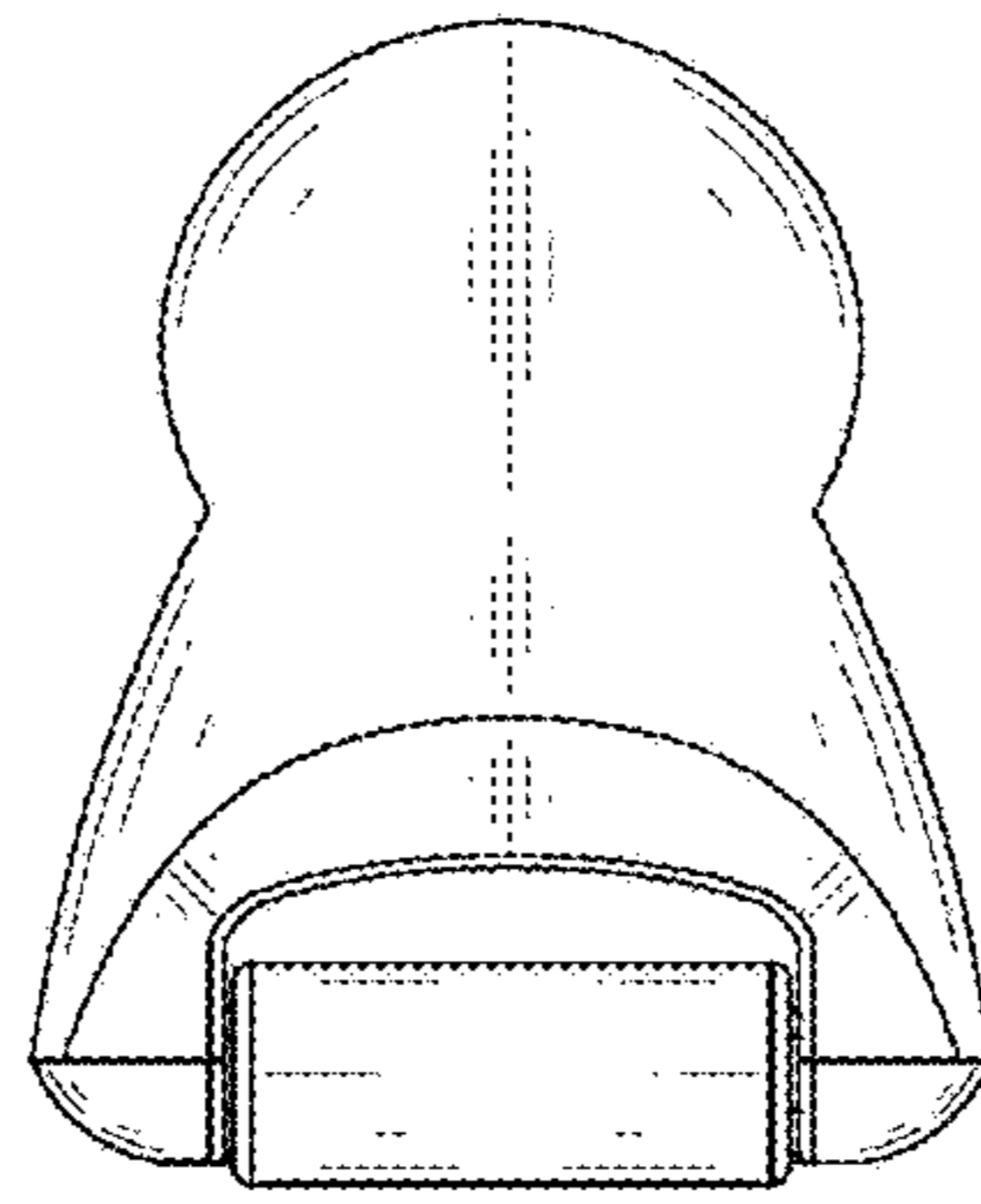

FIG. 3

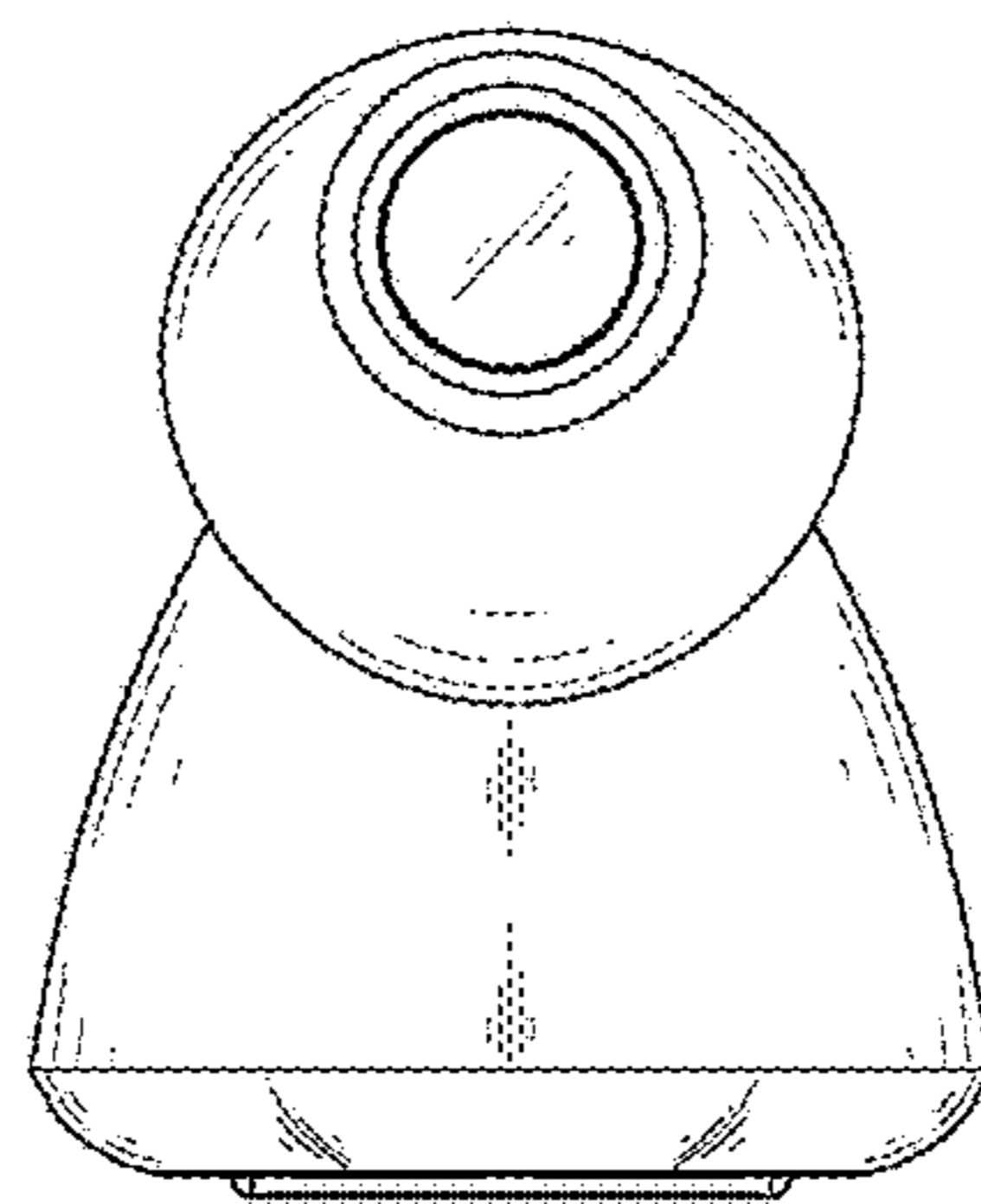

FIG. 4

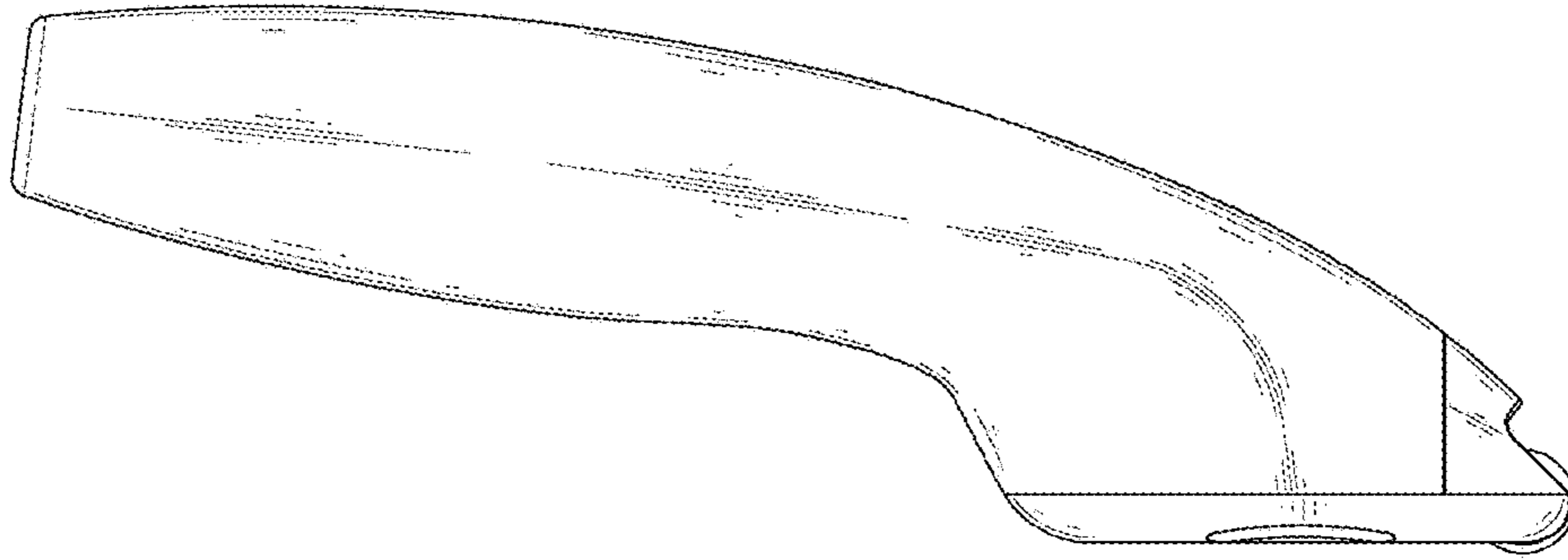

FIG. 5

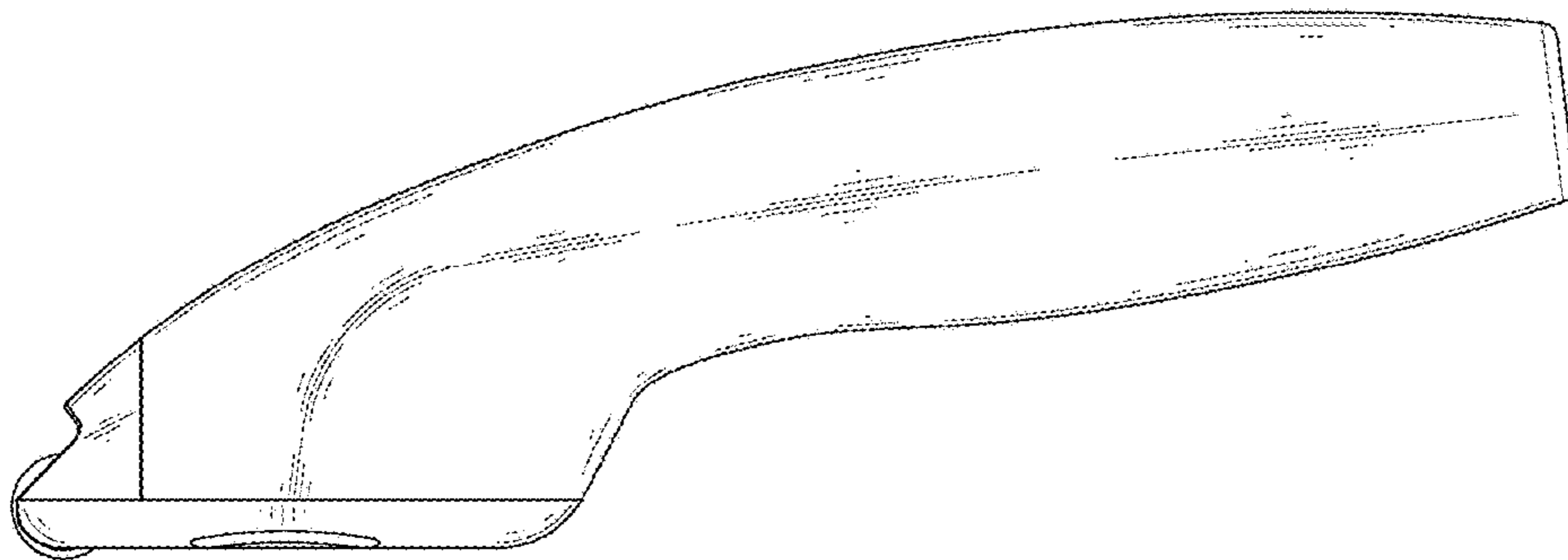

FIG. 6

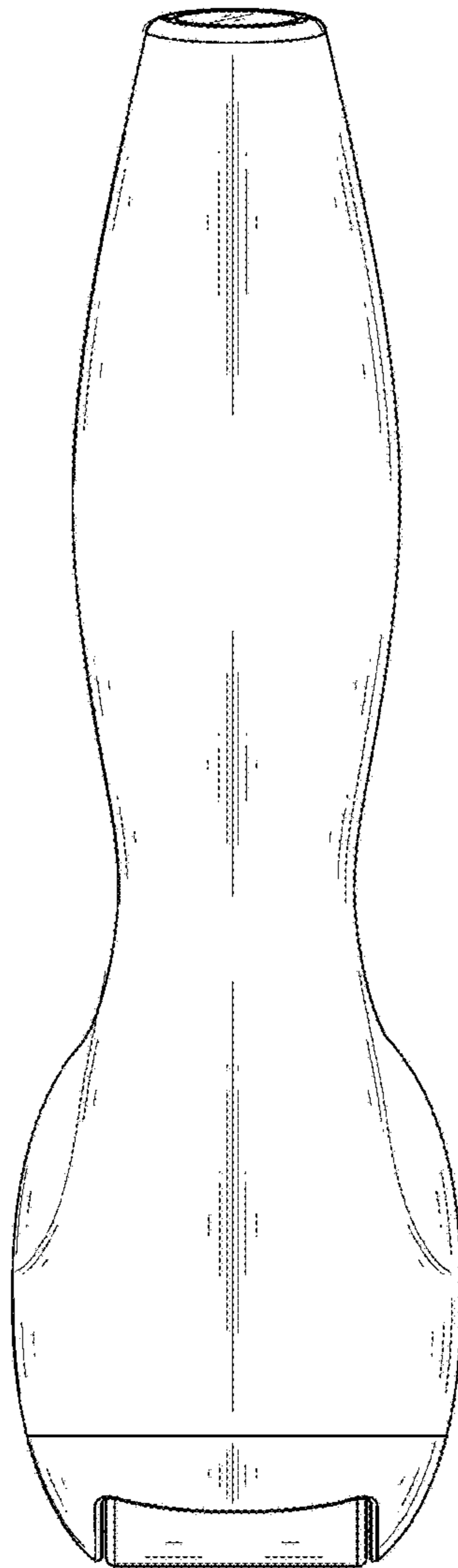

FIG. 7

