



US00D863478S

(12) **United States Design Patent**
Parsons et al.

(10) **Patent No.:** **US D863,478 S**
(45) **Date of Patent:** **** *Oct. 15, 2019**

(54) **GOLF CLUB HEAD**

- (71) Applicant: **PARSONS XTREME GOLF, LLC**,
Scottsdale, AZ (US)
- (72) Inventors: **Robert R. Parsons**, Scottsdale, AZ
(US); **Michael R. Nicolette**, Scottsdale,
AZ (US); **Bradley D. Schweigert**,
Anthem, AZ (US)
- (73) Assignee: **Parsons Xtreme Golf, LLC**,
Scottsdale, AZ (US)
- (*) Notice: This patent is subject to a terminal dis-
claimer.
- (**) Term: **15 Years**
- (21) Appl. No.: **29/622,326**
- (22) Filed: **Oct. 16, 2017**

Related U.S. Application Data

- (63) Continuation-in-part of application No. 29/618,845,
filed on Sep. 25, 2017, now abandoned, which is a
(Continued)
- (51) **LOC (12) Cl.** **21-02**
- (52) **U.S. Cl.**
USPC **D21/747**
- (58) **Field of Classification Search**
USPC D21/747-751, 759
(Continued)

References Cited

U.S. PATENT DOCUMENTS

- 1,133,129 A * 3/1915 Govan A63B 53/0466
473/337
- D164,469 S 9/1951 Behrendt
(Continued)

OTHER PUBLICATIONS

International Search Report and Written Opinion issued in connec-
tion with corresponding application No. PCT/US2015/016666, dated
May 14, 2015 (8 pages).

(Continued)

Primary Examiner — Mitchell I. Siegel

(57) **CLAIM**

The ornamental design for a golf club head, as shown and
described.

DESCRIPTION

FIG. 1 is a top perspective view of a golf club head;
FIG. 2 is a rear perspective view of the golf club head of
FIG. 1;
FIG. 3 is a front elevational view of the golf club head of
FIG. 1;
FIG. 4 is a rear elevational view of the golf club head of FIG.
1;
FIG. 5 is a top view of the golf club head of FIG. 1;
FIG. 6 is a bottom view of the golf club head of FIG. 1;
FIG. 7 is a left side view of the golf club head of FIG. 1;
FIG. 8 is a right side view of the golf club head of FIG. 1;
FIG. 9 is a top perspective view of a second embodiment of
a golf club head;
FIG. 10 is a rear perspective view of the golf club head of
FIG. 9;
FIG. 11 is a front elevational view of the golf club head of
FIG. 9;
FIG. 12 is a rear elevational view of the golf club head of
FIG. 9;
FIG. 13 is a top view of the golf club head of FIG. 9;
FIG. 14 is a bottom view of the golf club head of FIG. 9;
FIG. 15 is a left side view of the golf club head of FIG. 9;
and,
FIG. 16 is a right side view of the golf club head of FIG. 9.
The broken line showing on the golf club head is included
for the purpose of illustrating unclaimed subject matter and
forms no part of the claimed design.

1 Claim, 16 Drawing Sheets

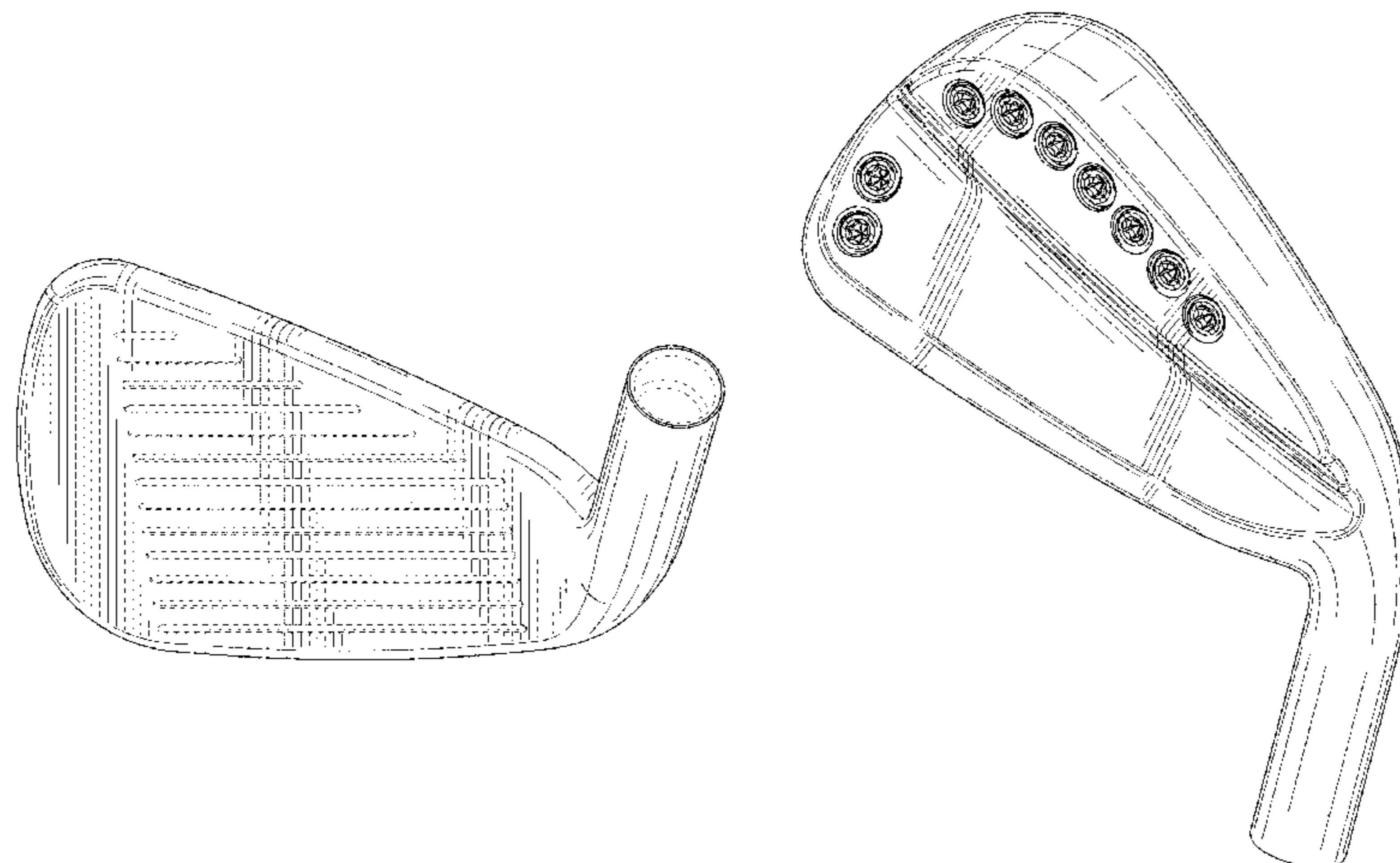

Related U.S. Application Data

continuation-in-part of application No. 29/611,387, filed on Jul. 20, 2017, now abandoned, application No. 29/622,326, which is a continuation-in-part of application No. 29/614,849, filed on Aug. 23, 2017, now abandoned.

(58) **Field of Classification Search**

CPC A63B 53/00; A63B 53/02; A63B 53/04; A63B 53/047; A63B 53/0475; A63B 2053/0479; A63B 2053/0483; A63B 2053/0445; A63B 60/00; A63B 60/46

See application file for complete search history.

(56)

References Cited

U.S. PATENT DOCUMENTS

3,020,048	A	2/1962	Carroll	
D203,936	S	3/1966	Long	
D215,101	S	9/1969	Sabat	
D234,963	S	4/1975	Hirata	
D239,550	S	4/1976	Timbrook	
D240,054	S	5/1976	Meissler	
D261,167	S	10/1981	Swanson	
D294,617	S *	3/1988	Perkins	D21/749
4,754,977	A *	7/1988	Sahm	A63B 53/04 473/337
4,824,116	A	4/1989	Nagarnoto et al.	
4,988,104	A	1/1991	Shiotani et al.	
5,158,296	A *	10/1992	Lee	A63B 53/04 473/327
5,176,384	A	1/1993	Sata et al.	
5,213,328	A	5/1993	Long et al.	
D336,672	S	6/1993	Gorman	
D353,862	S	12/1994	Saito	
D357,520	S	4/1995	Helmstetter et al.	
5,419,560	A	5/1995	Bamber	
5,425,535	A	6/1995	Gee	
D361,358	S	8/1995	Simmons	
5,447,311	A	9/1995	Viollaz et al.	
5,451,056	A	9/1995	Manning	
D362,884	S	10/1995	Bough et al.	
D362,885	S	10/1995	Bough et al.	
D362,887	S	10/1995	Bough et al.	
D370,514	S	6/1996	Bough et al.	
5,540,437	A	7/1996	Bamber	
D379,106	S	5/1997	Maltby	
5,637,045	A	6/1997	Igarashi	
5,669,830	A	9/1997	Bamber	
D389,541	S	1/1998	Huan-Chiang	
D395,476	S	6/1998	Pond et al.	
5,766,091	A	6/1998	Humphrey et al.	
5,766,092	A	6/1998	Mimeur et al.	
D399,277	S	10/1998	Ezaki	
5,827,132	A	10/1998	Bamber	
D408,485	S	4/1999	Takahashi et al.	
5,899,821	A	5/1999	Hsu et al.	
5,935,016	A	8/1999	Antonious	
D414,535	S	9/1999	Mertens	
D421,080	S *	2/2000	Chen	D21/747
D426,276	S	6/2000	Besnard et al.	
D426,476	S	6/2000	Goss	
6,077,171	A *	6/2000	Yoneyama	A63B 53/04 473/291
D442,659	S	5/2001	Kubica et al.	
D443,008	S	5/2001	Kubica et al.	
D445,862	S	7/2001	Ford	
6,290,609	B1	9/2001	Takeda	
D449,866	S	10/2001	Miller	
D457,211	S	5/2002	Bakke	
D458,328	S	6/2002	Solheim et al.	
D469,833	S	2/2003	Roberts et al.	
D473,605	S	4/2003	Petersen et al.	
D475,107	S	5/2003	Madore	
D476,048	S	6/2003	Cleveland et al.	

D478,949	S	8/2003	DeLaCruz	
6,638,182	B2	10/2003	Kosmatka	
6,695,714	B1	2/2004	Bliss et al.	
6,702,693	B2	3/2004	Bamber	
D492,376	S	6/2004	Nicolette et al.	
D494,240	S	8/2004	Schweigert	
D494,648	S	8/2004	Schweigert et al.	
6,780,123	B2	8/2004	Hasebe	
D497,963	S	11/2004	Toulon et al.	
6,811,496	B2	11/2004	Wahl et al.	
D499,779	S	12/2004	Mahaffey et al.	
D500,350	S	12/2004	Schweigert et al.	
D500,351	S	12/2004	Schweigert et al.	
D502,237	S	2/2005	Schweigert et al.	
D502,975	S	3/2005	Schweigert et al.	
D503,204	S	3/2005	Nicolette et al.	
D504,925	S	5/2005	Schweigert et al.	
D505,171	S	5/2005	Schweigert et al.	
D507,320	S	7/2005	Roberts et al.	
D507,614	S	7/2005	Schweigert et al.	
D508,099	S	8/2005	Schweigert et al.	
D508,545	S	8/2005	Roberts et al.	
6,923,733	B2	8/2005	Chen	
D514,183	S	1/2006	Schweigert et al.	
D516,650	S	3/2006	Wolfe et al.	
D518,863	S	4/2006	Motoyoshi et al.	
D523,501	S	6/2006	Nicolette et al.	
D523,917	S	6/2006	Wolfe et al.	
D524,889	S	7/2006	Yu et al.	
D530,759	S	10/2006	Nicolette et al.	
D530,760	S	10/2006	Schweigert et al.	
7,121,956	B2 *	10/2006	Lo	A63B 53/04 473/335
7,128,663	B2	10/2006	Bamber	
D532,849	S	11/2006	Nicolette et al.	
D534,228	S	12/2006	Nicolette et al.	
D534,595	S *	1/2007	Hasebe	D21/747
D534,597	S	1/2007	Nicolette et al.	
7,156,751	B2	1/2007	Wahl et al.	
D536,759	S	2/2007	Schweigert et al.	
D537,494	S	2/2007	Jertson et al.	
7,182,698	B2	2/2007	Tseng	
D538,366	S	3/2007	Nicolette et al.	
D539,864	S	4/2007	Nicolette et al.	
D540,898	S	4/2007	Solheim et al.	
D541,360	S	4/2007	Schweigert et al.	
7,207,900	B2	4/2007	Nicolette et al.	
D543,601	S *	5/2007	Kawami	D21/759
D544,056	S	6/2007	Nicolette et al.	
D547,410	S	7/2007	Nicolette et al.	
D555,219	S *	11/2007	Lin	D21/759
7,303,486	B2	12/2007	Imamoto	
D559,932	S	1/2008	Belmont	
D561,855	S	2/2008	Schweigert et al.	
D562,925	S	2/2008	Schweigert et al.	
7,351,164	B2	4/2008	Schweigert et al.	
D570,435	S	6/2008	Sanchez et al.	
D570,935	S	6/2008	Nicolette et al.	
D570,936	S	6/2008	Schweigert et al.	
D570,942	S	6/2008	Chen et al.	
D571,422	S	6/2008	Schweigert et al.	
D571,425	S	6/2008	Chen et al.	
D571,427	S	6/2008	Schweigert et al.	
D571,881	S	6/2008	Nicolette et al.	
D572,326	S	7/2008	Schweigert et al.	
D572,329	S	7/2008	Nicolette et al.	
D573,219	S	7/2008	Schweigert et al.	
7,396,299	B2	7/2008	Nicolette et al.	
7,413,518	B2	8/2008	Cole et al.	
D577,783	S	9/2008	Schweigert et al.	
D578,590	S	10/2008	Schweigert et al.	
D581,000	S	11/2008	Nicolette et al.	
D581,004	S	11/2008	Schweigert et al.	
D584,370	S	1/2009	Cleveland et al.	
D594,518	S	6/2009	Schweigert	
D596,256	S	7/2009	Schweigert et al.	
D596,257	S	7/2009	Jertson et al.	
D596,258	S	7/2009	Jertson et al.	
D596,688	S	7/2009	Schweigert et al.	

(56)

References Cited

U.S. PATENT DOCUMENTS

D597,158 S 7/2009 Schweigert et al.
D601,216 S 9/2009 Jertson et al.
7,588,502 B2* 9/2009 Nishino A63B 53/0466
473/332
7,601,075 B2 10/2009 Cole et al.
D604,783 S 11/2009 Nicolette et al.
7,611,424 B2 11/2009 Nagai et al.
D606,605 S 12/2009 Wada et al.
D607,070 S 12/2009 Wada et al.
D607,071 S 12/2009 Wada et al.
7,658,686 B2 2/2010 Soracco
D612,438 S 3/2010 Carlyle et al.
D612,439 S 3/2010 Carlyle et al.
D617,406 S 6/2010 Carlyle et al.
D618,293 S 6/2010 Foster et al.
D621,894 S 6/2010 Schweigert
7,736,243 B2 6/2010 Sanchez et al.
7,744,484 B1 6/2010 Chao
D621,893 S 8/2010 Nicolette et al.
D621,895 S 8/2010 Schweigert et al.
7,798,917 B2 9/2010 Nguyen et al.
7,815,521 B2 10/2010 Ban et al.
D627,409 S 11/2010 Schweigert et al.
D627,410 S 11/2010 Nicolette et al.
7,846,040 B2 12/2010 Ban
D633,159 S 2/2011 Holt
D633,967 S 3/2011 Carlyle et al.
D635,627 S 4/2011 Nicolette
7,938,738 B2 5/2011 Roach
D643,488 S 6/2011 Holt
D642,642 S 8/2011 Jertson et al.
D643,490 S 8/2011 Wada et al.
D643,491 S 8/2011 Stokke et al.
D643,492 S 8/2011 Nicolette et al.
D643,895 S 8/2011 Wieland
D643,896 S 8/2011 Jertson et al.
D647,582 S 10/2011 Nicolette et al.
D649,211 S 11/2011 Jertson et al.
8,062,150 B2 11/2011 Gilbert et al.
D651,268 S 12/2011 Nicolette et al.
8,088,025 B2 1/2012 Wahl et al.
8,092,319 B1 1/2012 Cackett et al.
8,105,180 B1 1/2012 Cackett et al.
8,142,307 B2 3/2012 Sanchez et al.
D658,248 S 4/2012 Nunez et al.
8,221,262 B1 7/2012 Cackett et al.
8,246,487 B1* 8/2012 Cackett A63B 53/06
473/334
D670,775 S 11/2012 Jertson et al.
D672,417 S 12/2012 Jertson et al.
8,328,662 B2 12/2012 Nakamura et al.
D673,633 S 1/2013 Jertson et al.
D673,634 S 1/2013 Jertson et al.
8,376,878 B2 2/2013 Bennett et al.
D680,603 S 4/2013 Nicolette et al.
D681,142 S 4/2013 Fossum et al.
D681,143 S 4/2013 Nicolette et al.
8,414,422 B2 4/2013 Peralta et al.
8,506,420 B2 8/2013 Hocknell et al.
8,545,343 B2 10/2013 Boyd et al.
8,574,094 B2 11/2013 Nicolette et al.
8,657,700 B2 2/2014 Nicolette et al.
8,663,026 B2 3/2014 Bowers et al.
8,690,710 B2 4/2014 Nicolette et al.
D707,316 S 6/2014 Aguayo et al.
D707,317 S 6/2014 Aguayo et al.
8,753,230 B2 6/2014 Stokke et al.
D708,688 S 7/2014 Nicolette et al.
8,827,832 B2 9/2014 Breier et al.

8,827,833 B2 9/2014 Amano et al.
8,845,455 B2 9/2014 Ban et al.
D716,387 S 10/2014 Aguayo et al.
D716,388 S 10/2014 Aguayo et al.
D722,352 S * 2/2015 Nicolette D21/747
D723,120 S * 2/2015 Nicolette D21/747
8,961,336 B1* 2/2015 Parsons A63B 53/0475
473/332
D726,265 S * 4/2015 Nicolette D21/747
9,199,143 B1 12/2015 Parsons et al.
D746,926 S * 1/2016 Parsons D21/747
D748,214 S * 1/2016 Nicolette D21/747
D746,749 S 2/2016 Nicolette et al.
D748,749 S * 2/2016 Nicolette D21/759
D756,471 S * 5/2016 Nicolette D21/747
D764,610 S * 8/2016 Parsons D21/747
9,421,437 B2 8/2016 Parsons et al.
9,427,634 B2 8/2016 Parsons et al.
D773,575 S * 12/2016 Nicolette D21/747
D802,068 S * 11/2017 Parsons D21/747
D816,787 S * 5/2018 Nicolette D21/747
D827,065 S * 8/2018 Nicolette D21/747
D835,737 S * 12/2018 Parsons D21/747
2002/0107087 A1 8/2002 Fagot
2003/0139226 A1 7/2003 Cheng et al.
2003/0176231 A1 9/2003 Hasebe
2004/0204263 A1 10/2004 Fagot et al.
2005/0009832 A1 1/2005 Sun et al.
2005/0014573 A1 1/2005 Lee
2005/0096148 A1 5/2005 Noble et al.
2005/0119066 A1 6/2005 Stites et al.
2005/0239569 A1 10/2005 Best et al.
2005/0277485 A1 12/2005 Hou et al.
2006/0111200 A1 5/2006 Poynor
2007/0032308 A1 2/2007 Fagot et al.
2007/0225084 A1 9/2007 Schweigert et al.
2008/0058113 A1 3/2008 Nicolette et al.
2008/0188322 A1 8/2008 Anderson et al.
2008/0300065 A1 12/2008 Schweigert
2009/0029790 A1 1/2009 Nicolette et al.
2010/0130306 A1 5/2010 Schweigert
2010/0178999 A1 7/2010 Nicolette et al.
2011/0111883 A1 5/2011 Cackett
2011/0165963 A1 7/2011 Cackett et al.
2011/0269567 A1 11/2011 Ban et al.
2011/0294596 A1 12/2011 Ban
2013/0137532 A1 5/2013 Deshmukh et al.
2013/0225319 A1 8/2013 Kato
2013/0281226 A1 10/2013 Ban
2013/0288623 A1 10/2013 Hebreo
2013/0303303 A1 11/2013 Ban
2013/0310192 A1 11/2013 Wahl et al.
2014/0080621 A1 3/2014 Nicolette et al.
2014/0128175 A1 5/2014 Jertson et al.
2014/0274441 A1 9/2014 Greer
2014/0274451 A1 9/2014 Knight et al.
2015/0231454 A1 8/2015 Parsons et al.
2015/0231806 A1 8/2015 Parsons et al.

OTHER PUBLICATIONS

Kozuchowski, Zak, "Callaway Mack Daddy 2 PM Grind Wedges" (<http://www.golfwrx.com/276203/callaway-mack-daddy-2-pm-grind-wedges/>), www.golfwrx.com, GolfWRX Holdings, LLC, published Jan. 21, 2015.
Wall, Jonathan, "Details: Phil's Prototype Mack Daddy PM-Grind Wedge," (<http://www.pgatour.com/equipmentreport/2015/01/21/callaway-wedge.html>), www.pgatour.com, PGA Tour, Inc., published Jan. 21, 2015.

* cited by examiner

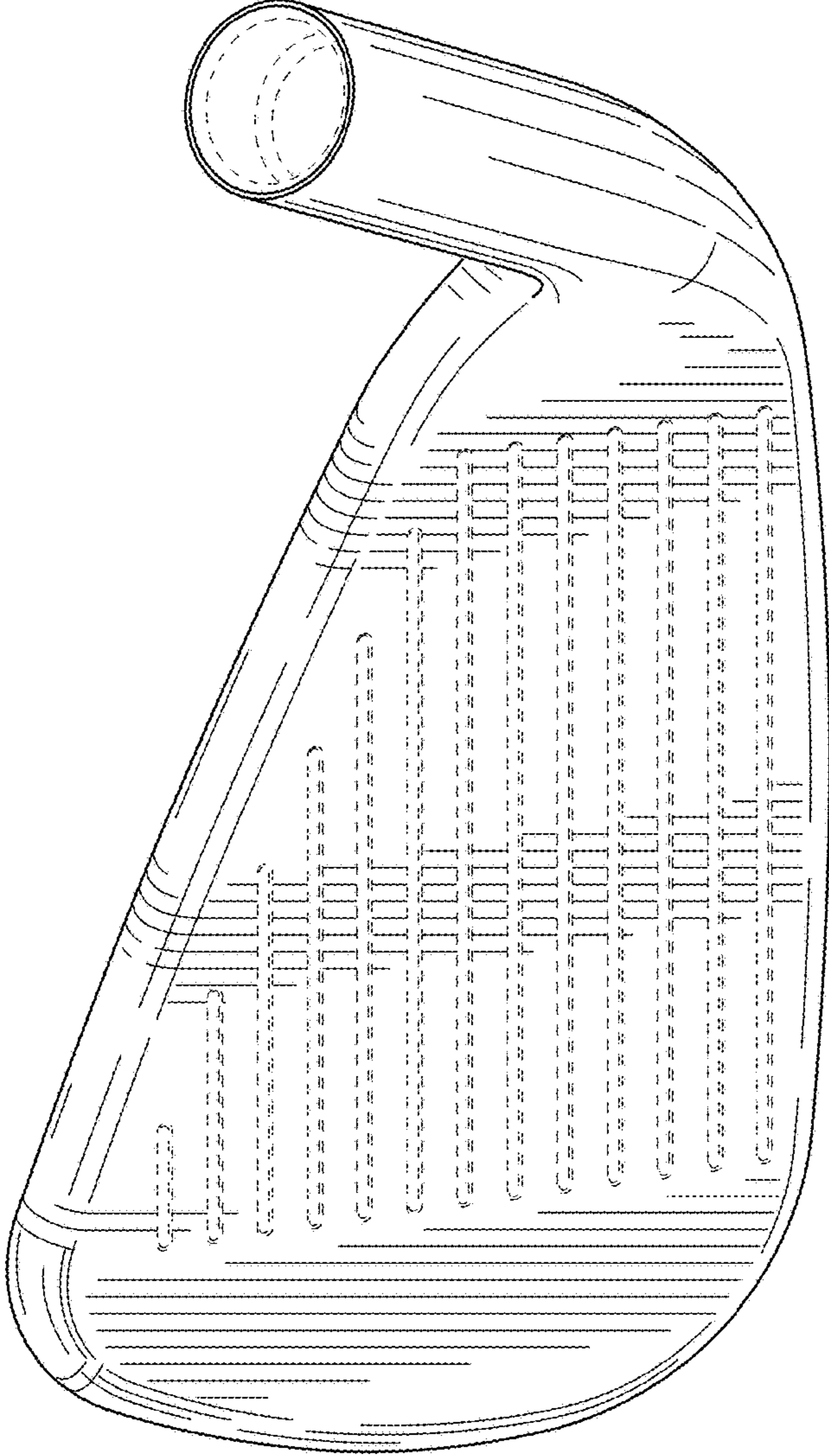

FIG. 1

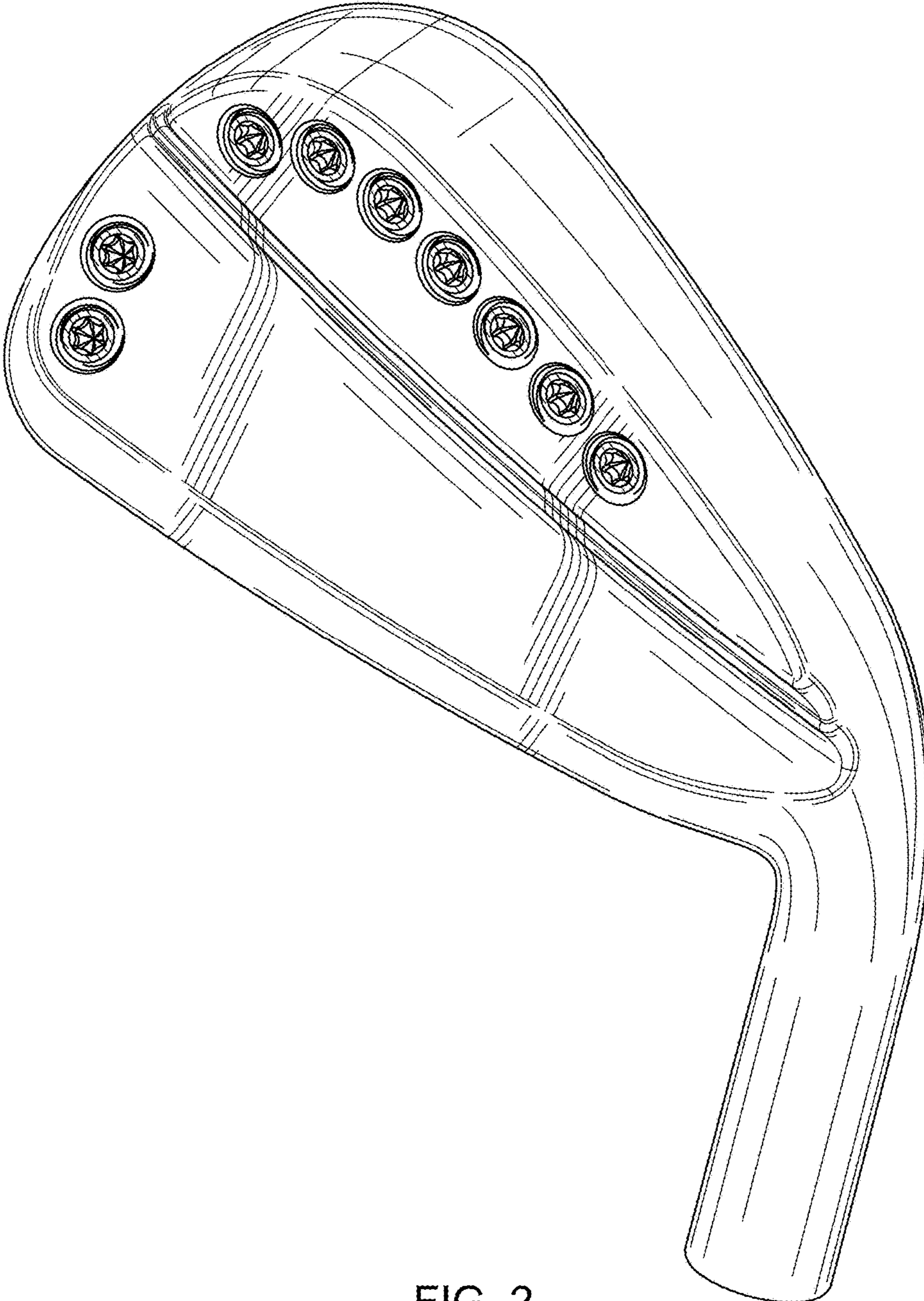

FIG. 2

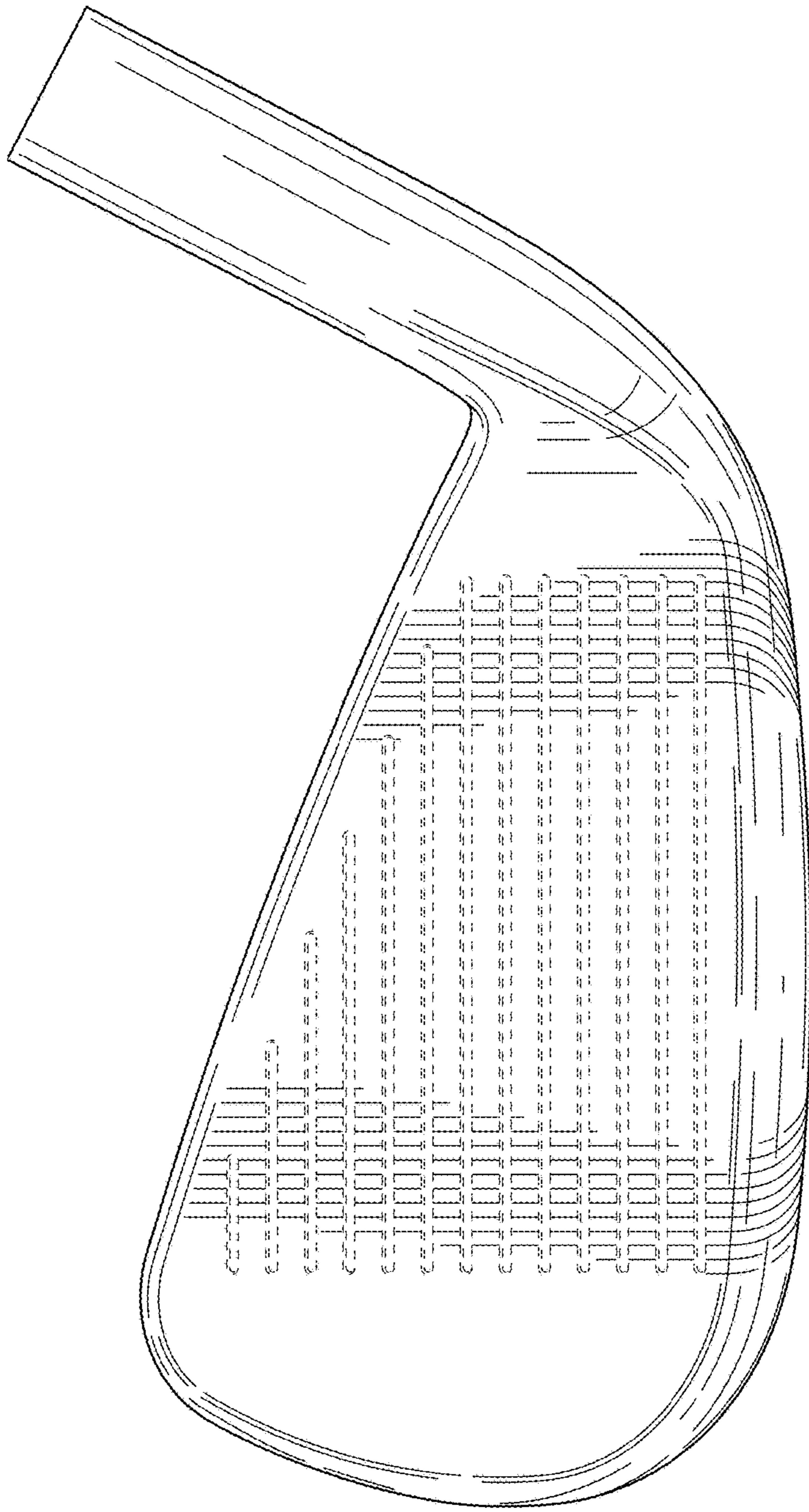

FIG. 3

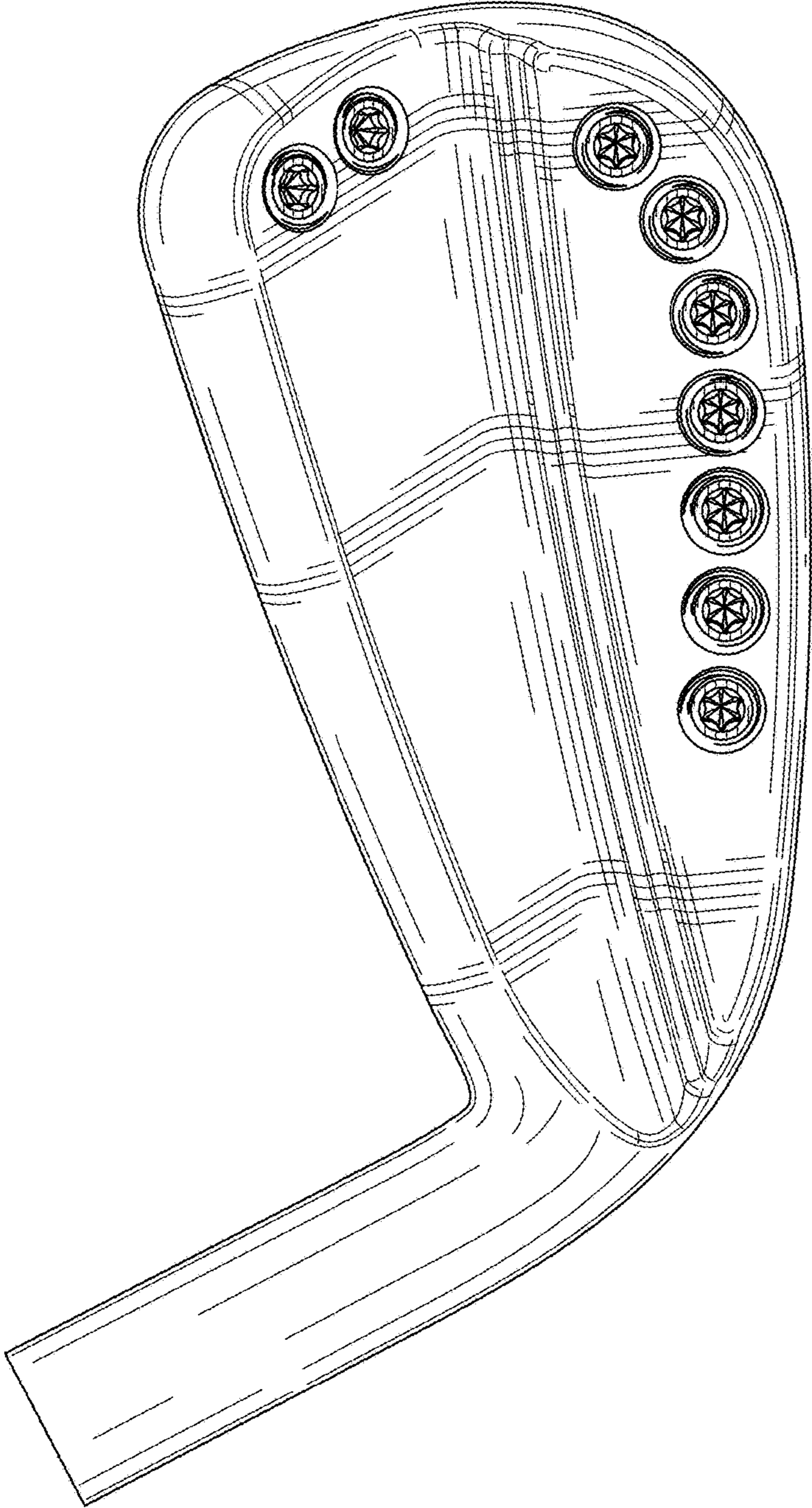

FIG. 4

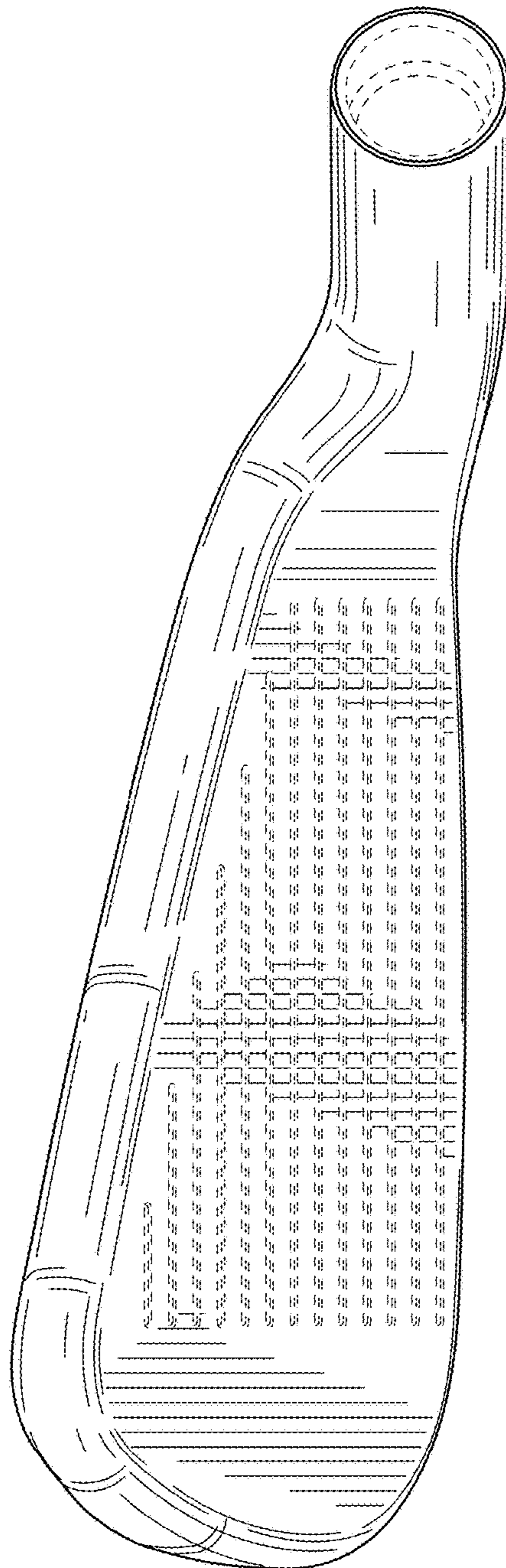

FIG. 5

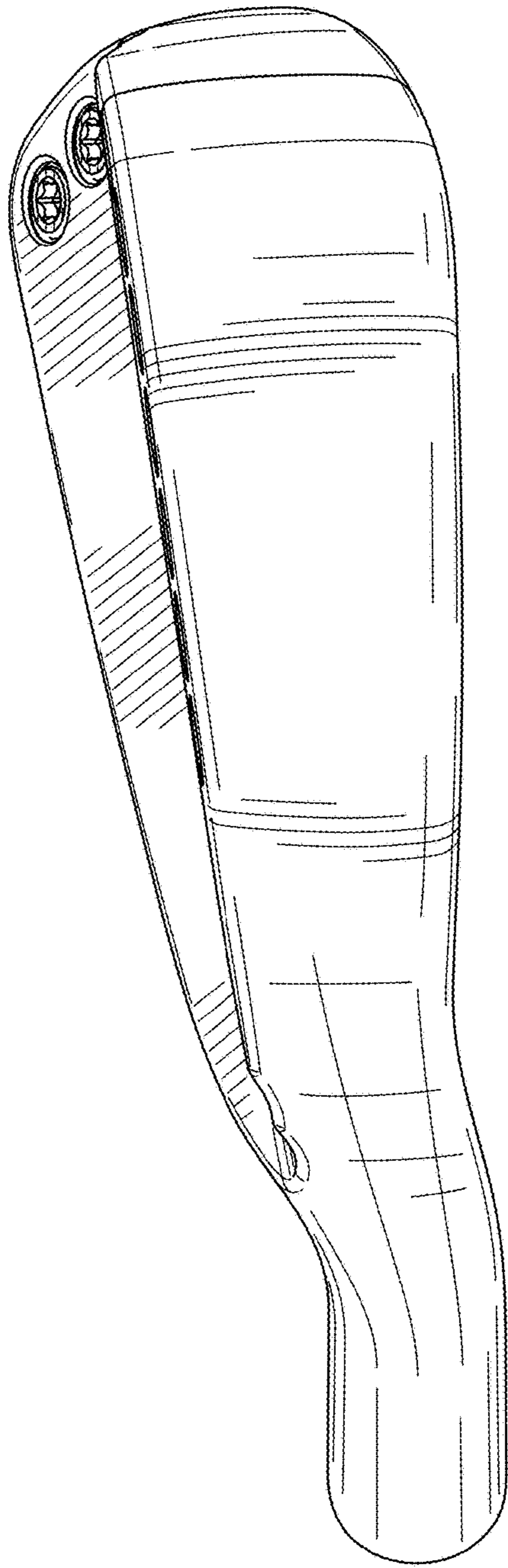

FIG. 6

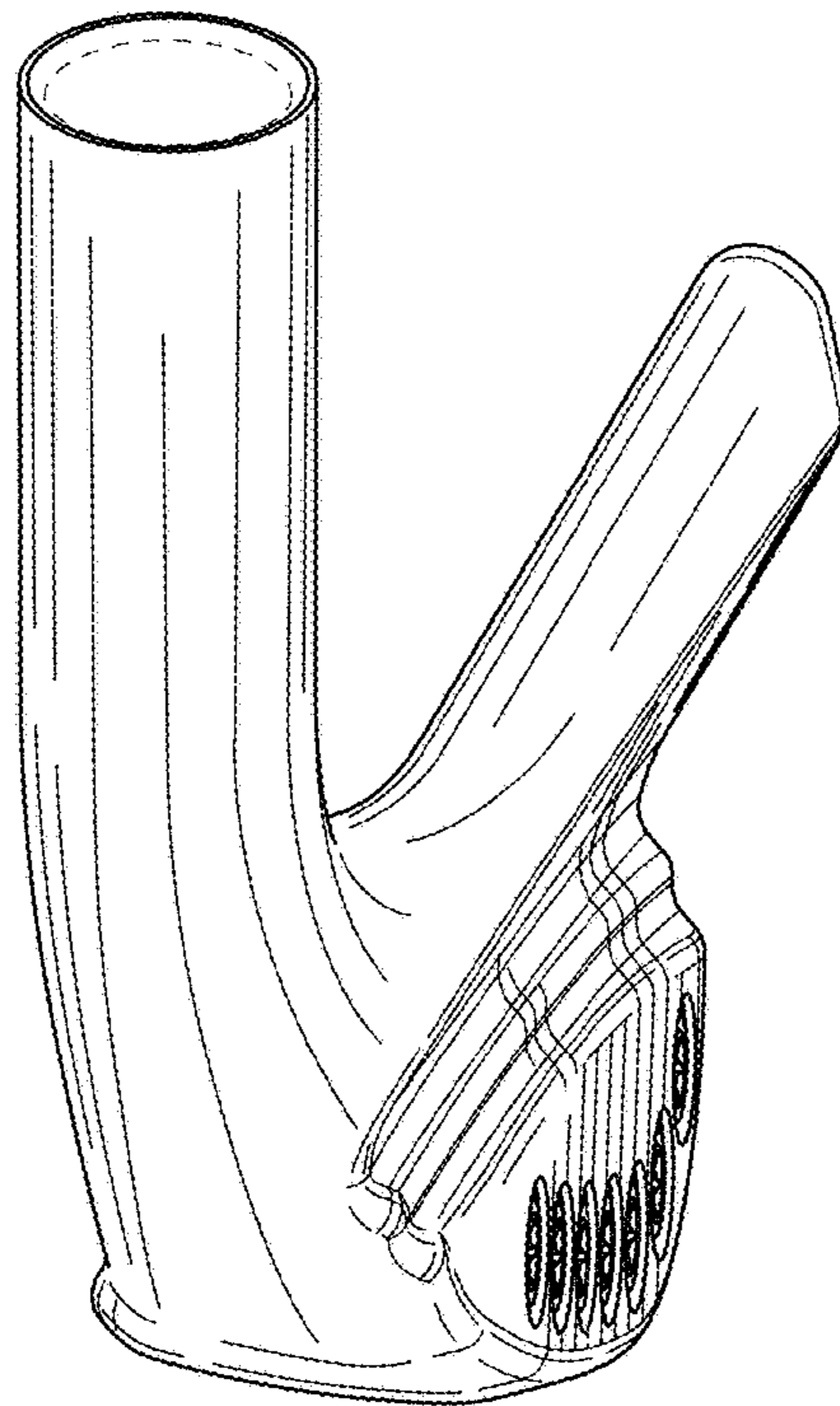

FIG. 7

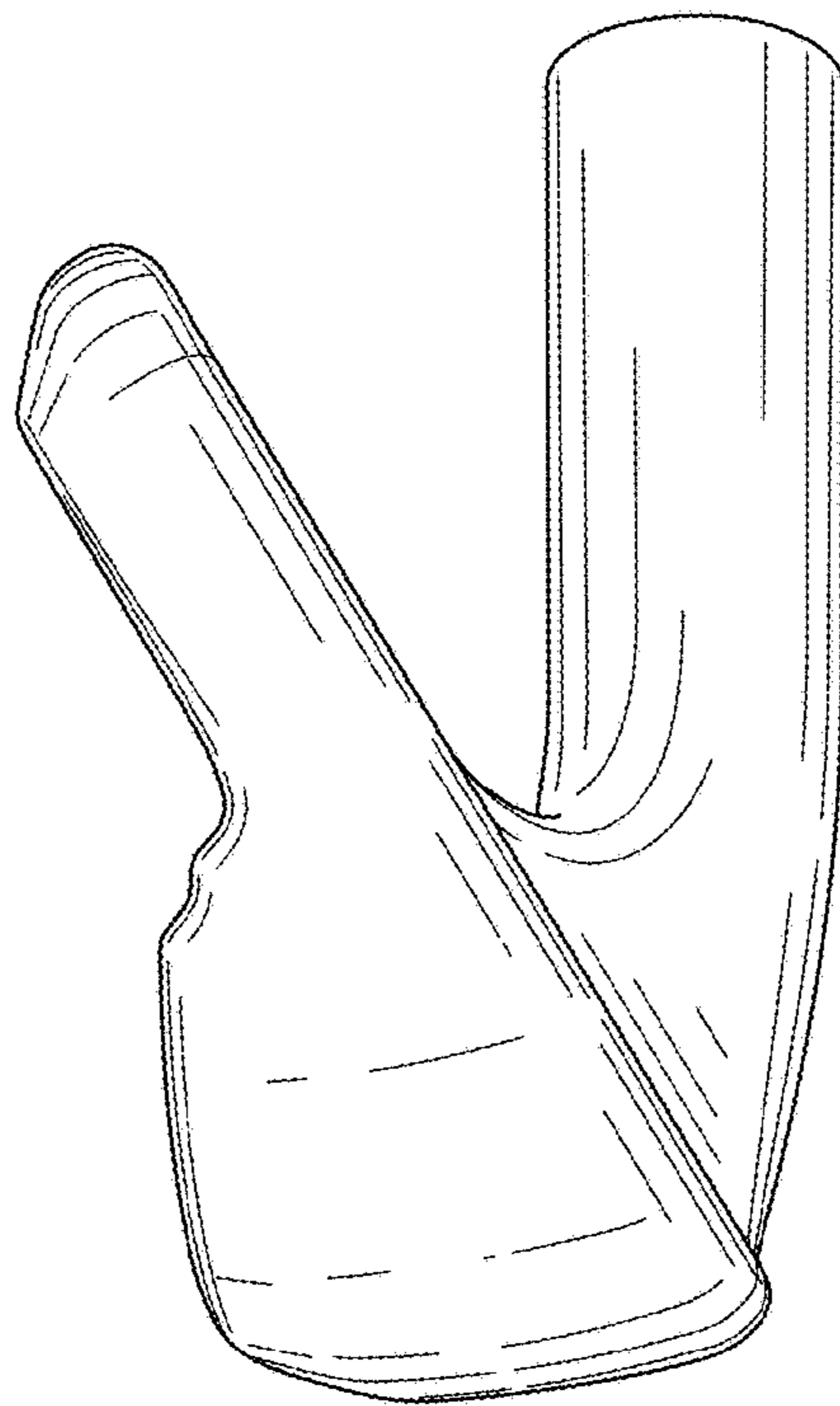

FIG. 8

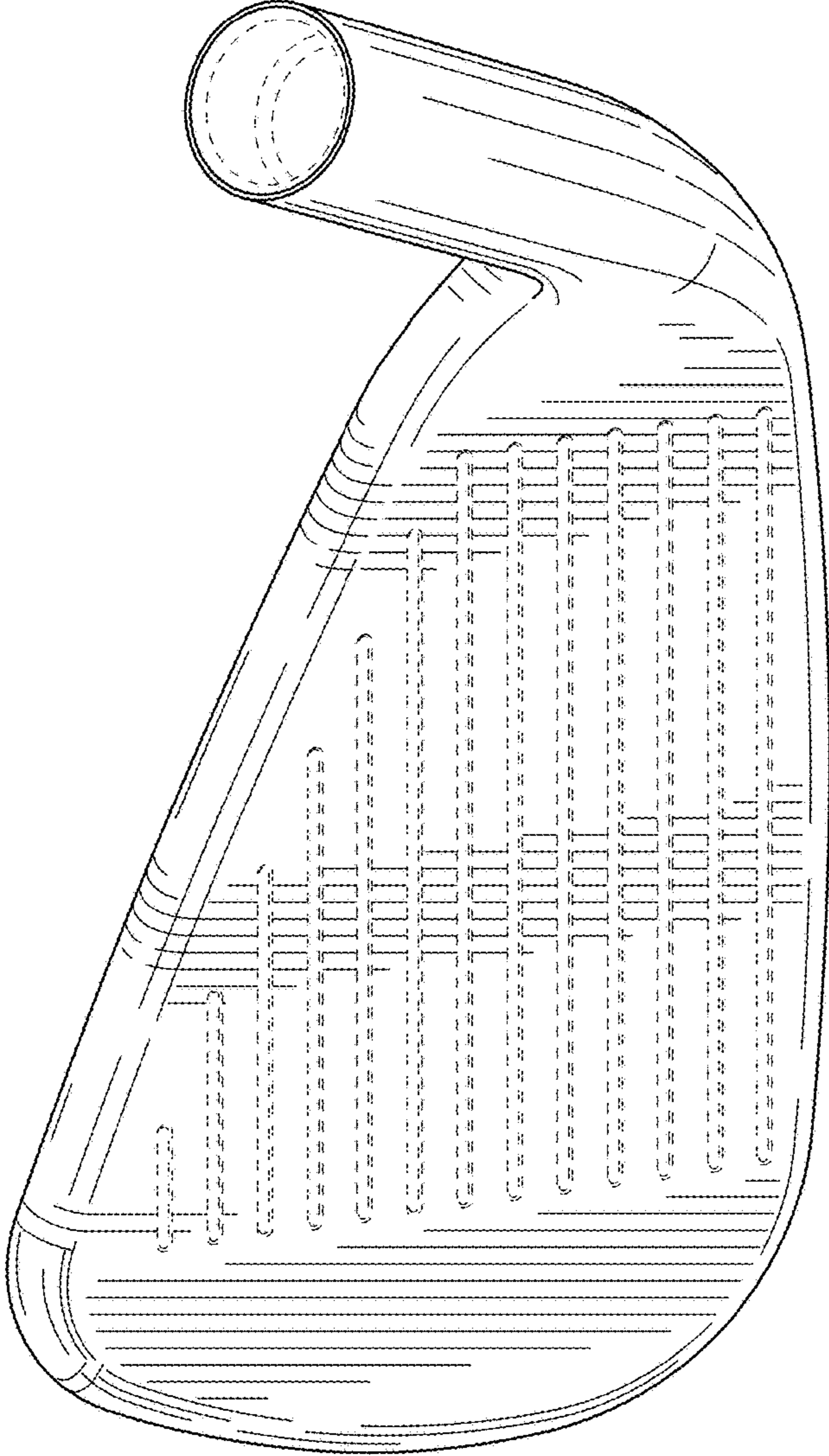

FIG. 9

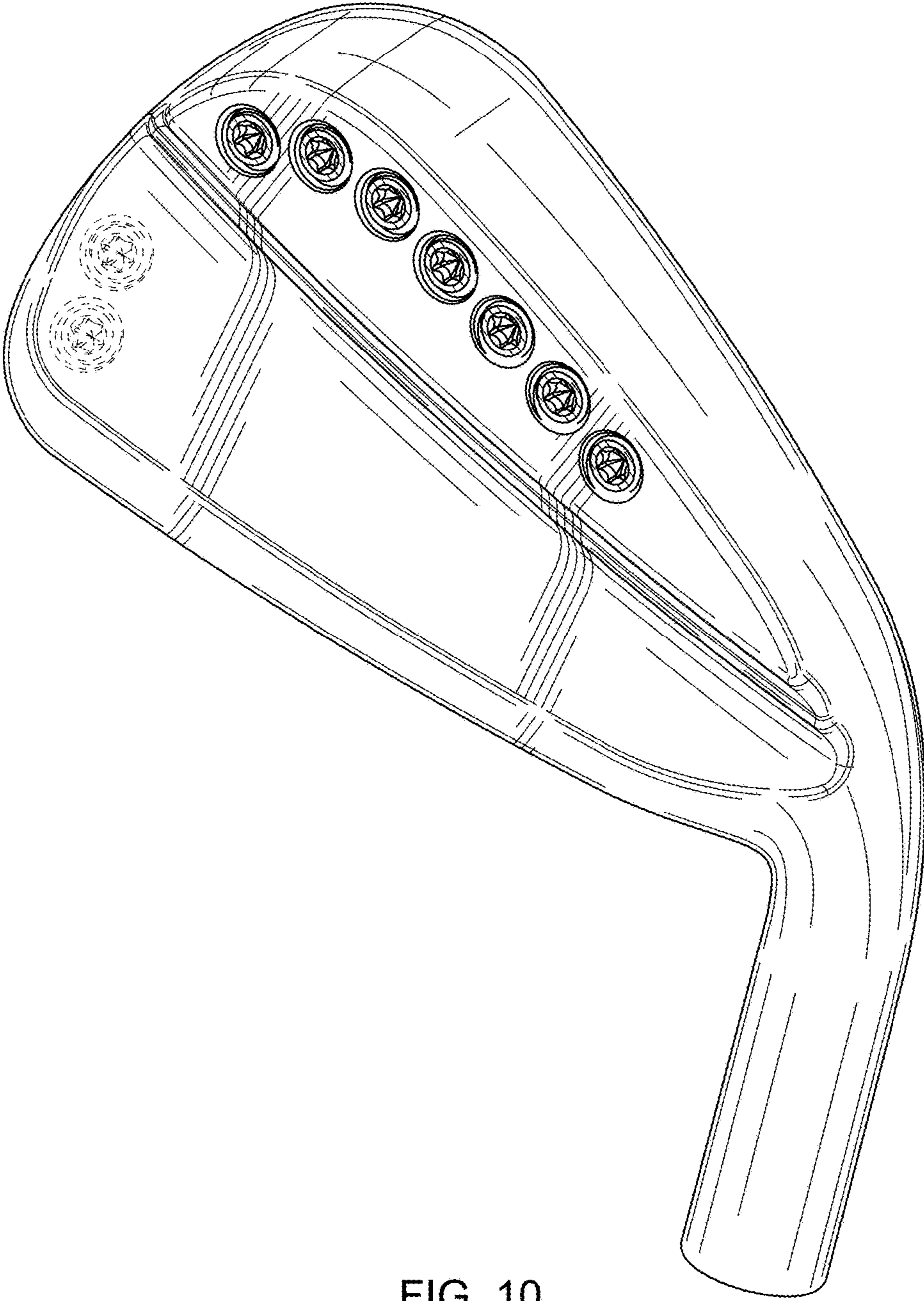

FIG. 10

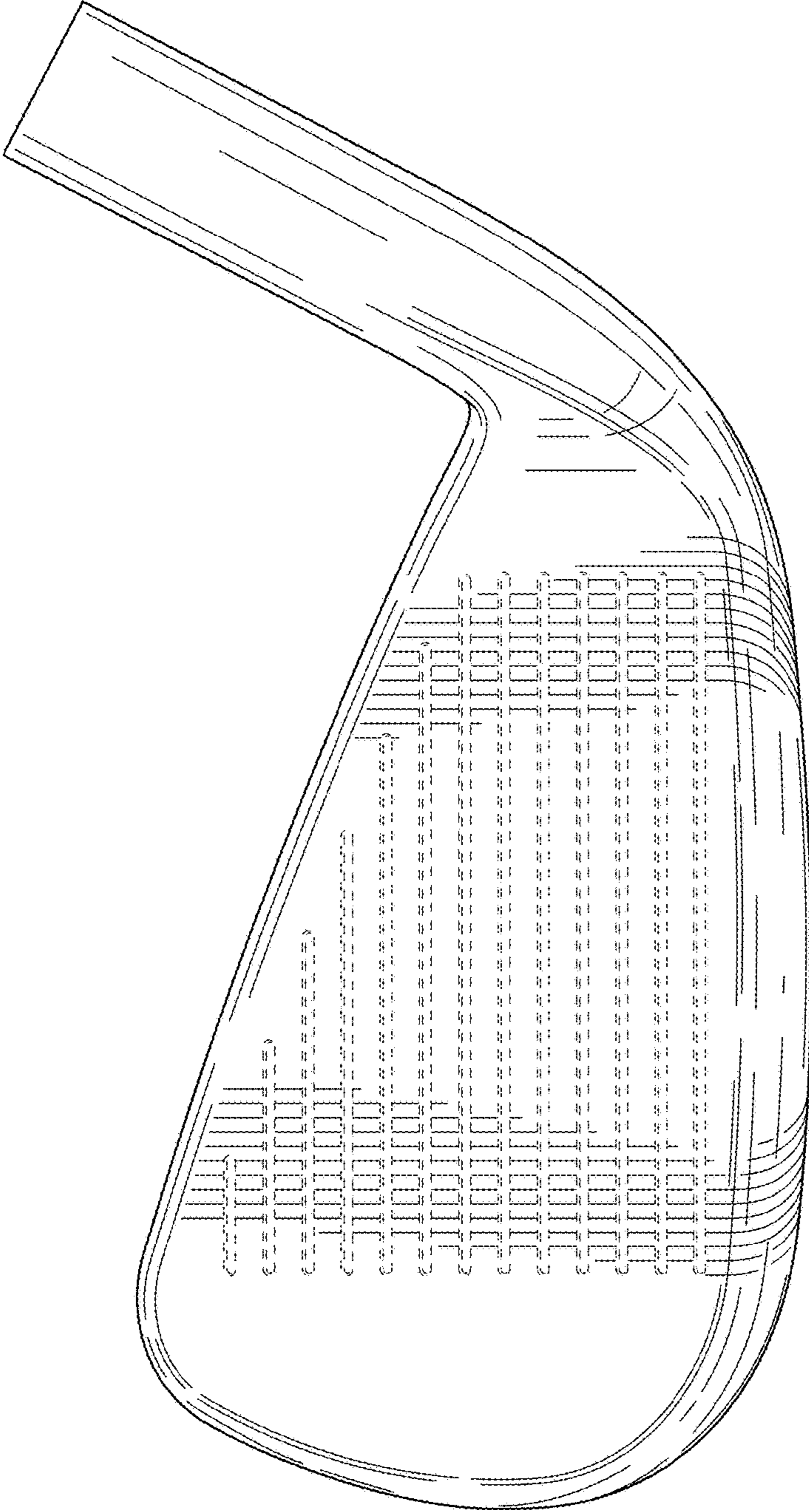

FIG. 11

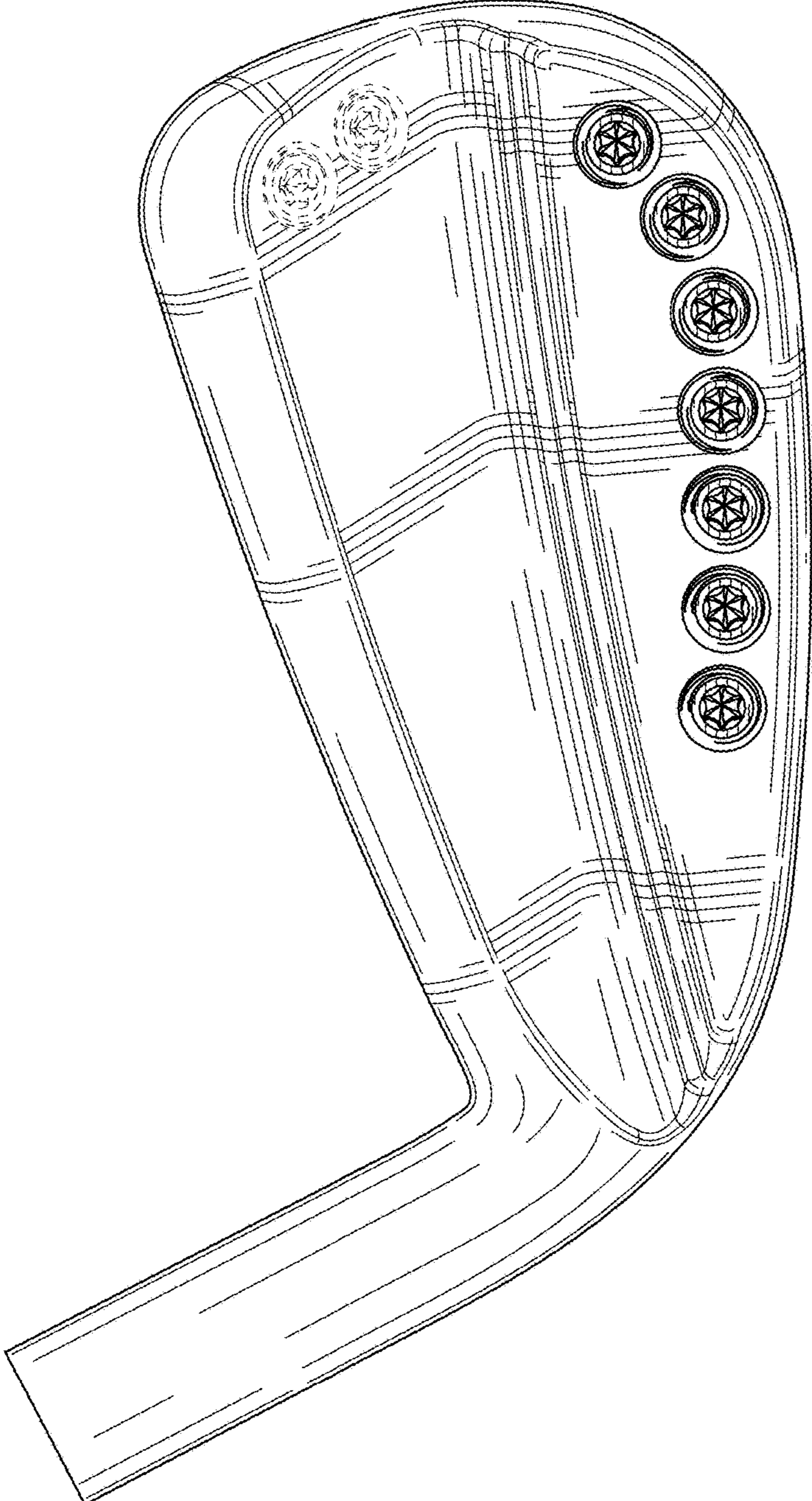

FIG. 12

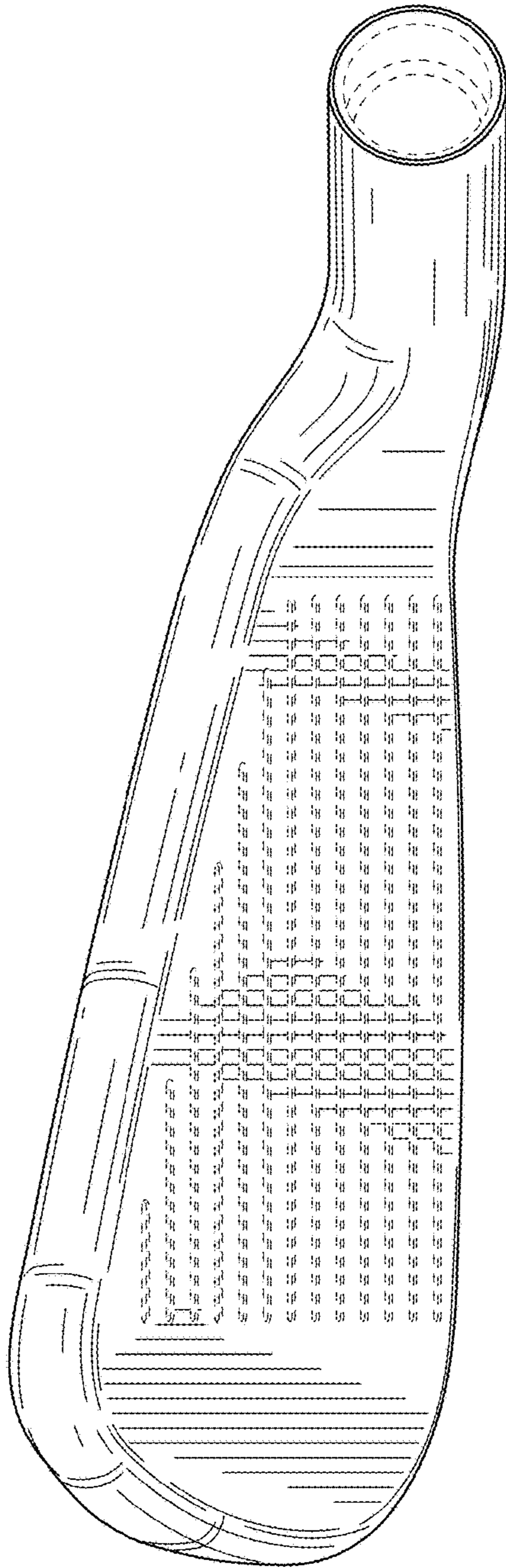

FIG. 13

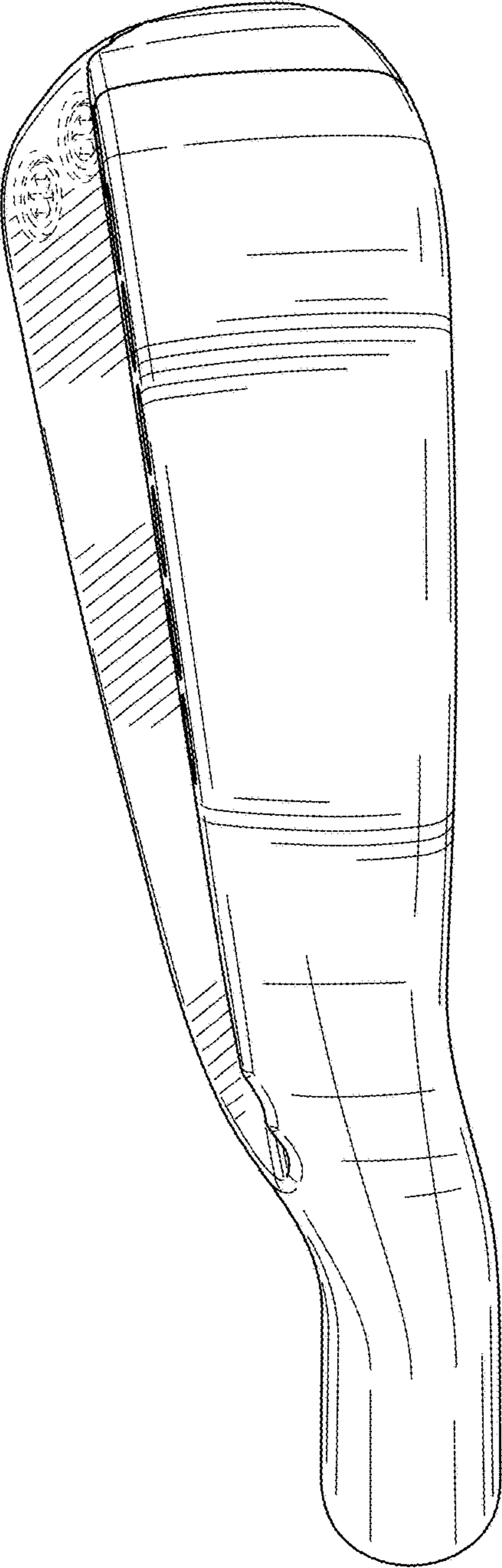

FIG. 14

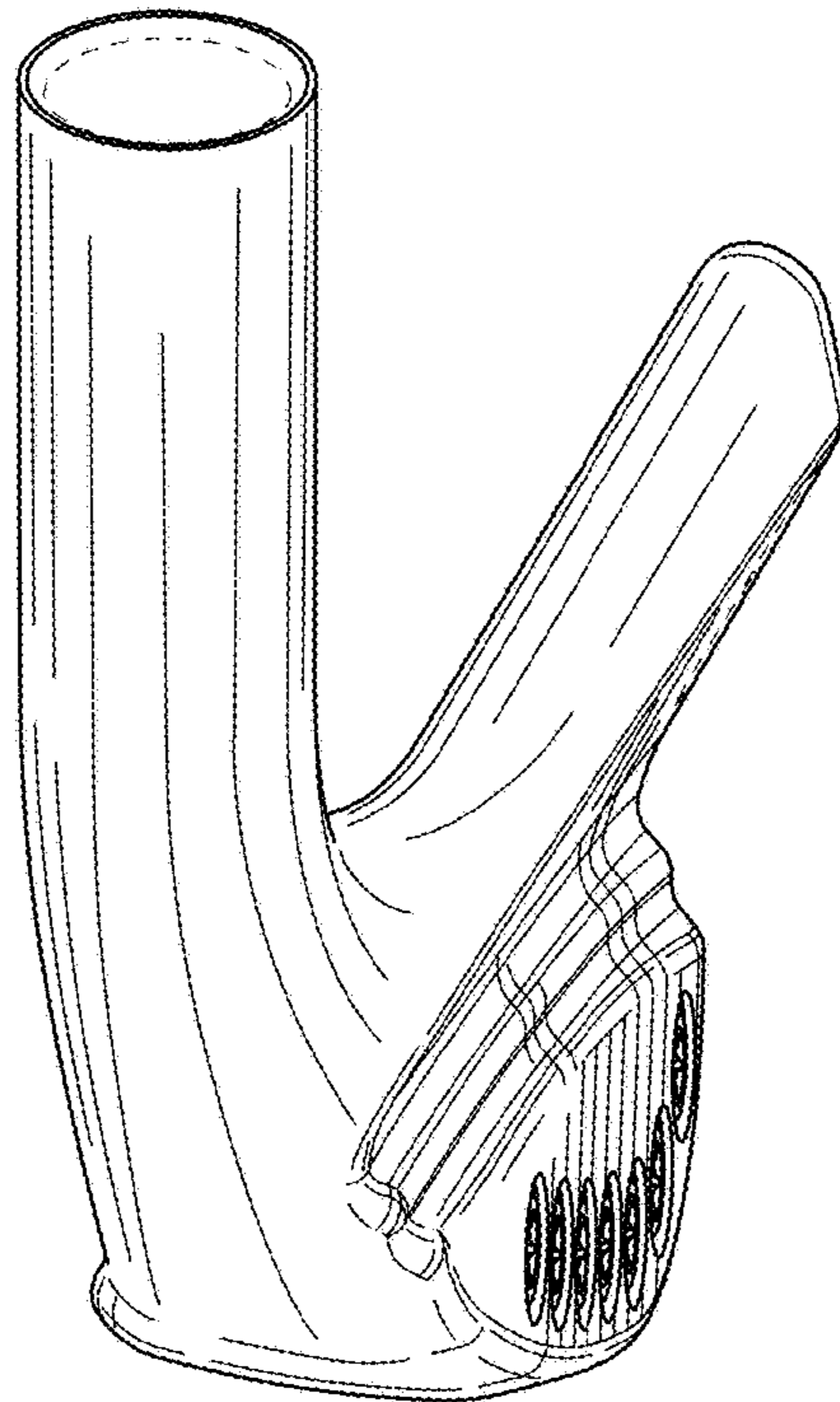

FIG. 15

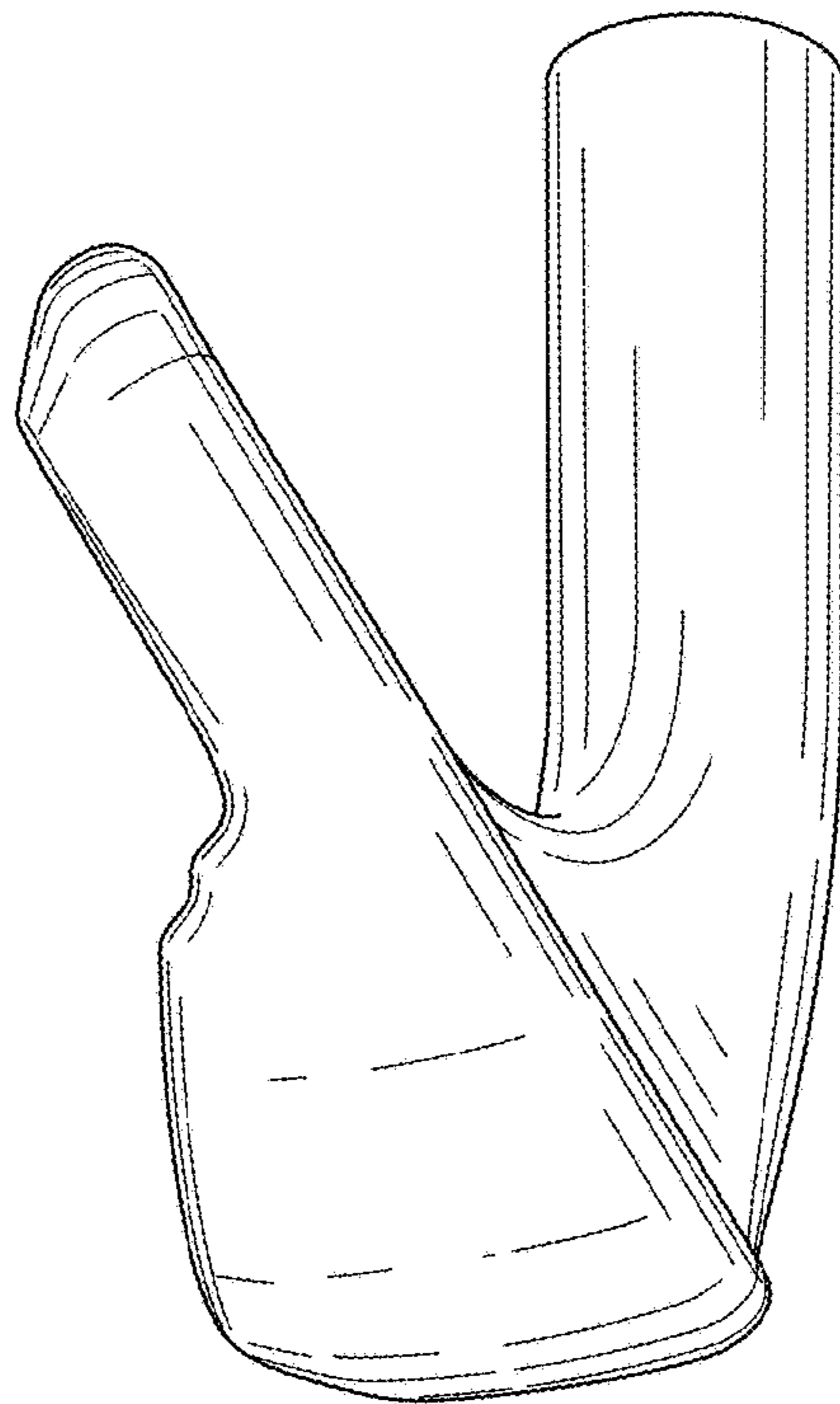

FIG. 16