



US00D863260S

(12) **United States Design Patent**
Zheng

(10) **Patent No.:** **US D863,260 S**
(45) **Date of Patent:** **** Oct. 15, 2019**

(54) **PAIR OF WIRELESS EARPHONES**

- (71) Applicant: **Shenzhen Sabbat Technology Development Co., Ltd.**, Shenzhen (CN)
- (72) Inventor: **Bin Zheng**, Shenzhen (CN)
- (73) Assignee: **Shenzhen Sabbat Technology Development Co., Ltd.**, Shenzhen (CN)
- (**) Term: **15 Years**
- (21) Appl. No.: **29/628,885**
- (22) Filed: **Dec. 8, 2017**
- (51) **LOC (12) Cl.** **14-01**
- (52) **U.S. Cl.**
USPC **D14/223**
- (58) **Field of Classification Search**
USPC D14/223, 205; D24/174; 181/129, 130, 181/135; 379/430, 431; 381/380, 381, 381/370, 374; 455/90.3, 575.1, 569.1
CPC H04R 1/10; H04R 25/00; H04R 25/02; H04R 1/1066; H04R 1/1016; H04R 5/033; H04R 5/0335
See application file for complete search history.

(56) **References Cited**

U.S. PATENT DOCUMENTS

- 1,852,130 A * 4/1932 Schier H04R 25/656
381/328
- D102,655 S * 1/1937 Nicholides D24/174
- D266,271 S * 9/1982 Johanson D24/174

(Continued)

Primary Examiner — Paula Allen Greene

(74) *Attorney, Agent, or Firm* — Leason Ellis LLP

(57) **CLAIM**

I claim the ornamental design for a pair of wireless ear-phones, as shown and described.

DESCRIPTION

FIG. 1 is a perspective view showing a new design for the pair of wireless earphones, as may be fitted into a user's left ear.

FIG. 2 is a front elevation view of the pair of wireless earphones of FIG. 1.

FIG. 3 is a back elevation view of the pair of wireless earphones of FIG. 1.

FIG. 4 is a right side elevation view thereof.

FIG. 5 is a left side elevation view thereof.

FIG. 6 is a top or plan view thereof.

FIG. 7 is a bottom view thereof.

FIG. 8 is a perspective view showing a new design for the pair of wireless earphones, as may be fitted into a user's right ear.

FIG. 9 is a front elevation view of the pair of wireless earphones of FIG. 8.

FIG. 10 is a back elevation view of the pair of wireless earphones of FIG. 8.

FIG. 11 is a right side elevation view thereof.

FIG. 12 is a left side elevation view thereof.

FIG. 13 is a top or plan view thereof.

FIG. 14 is a bottom view thereof.

FIG. 15 is a perspective view showing a new design for a pair of wireless earphones, as may be fitted into a user's ears.

FIG. 16 is a front elevation view of the pair of wireless earphones of FIG. 15.

FIG. 17 is a back elevation view of the pair of wireless earphones of FIG. 15.

FIG. 18 is a right side elevation view thereof.

FIG. 19 is a left side elevation view thereof.

FIG. 20 is a top or plan view thereof; and,

FIG. 21 is a bottom view thereof.

Certain lines are presented herein to provide shading or contour in order to provide a fuller understanding of the pair of wireless earphones. Such shading lines form no part of the claimed design.

The broken lines in the drawings depict environmental structure and form no part of the claimed design.

1 Claim, 11 Drawing Sheets

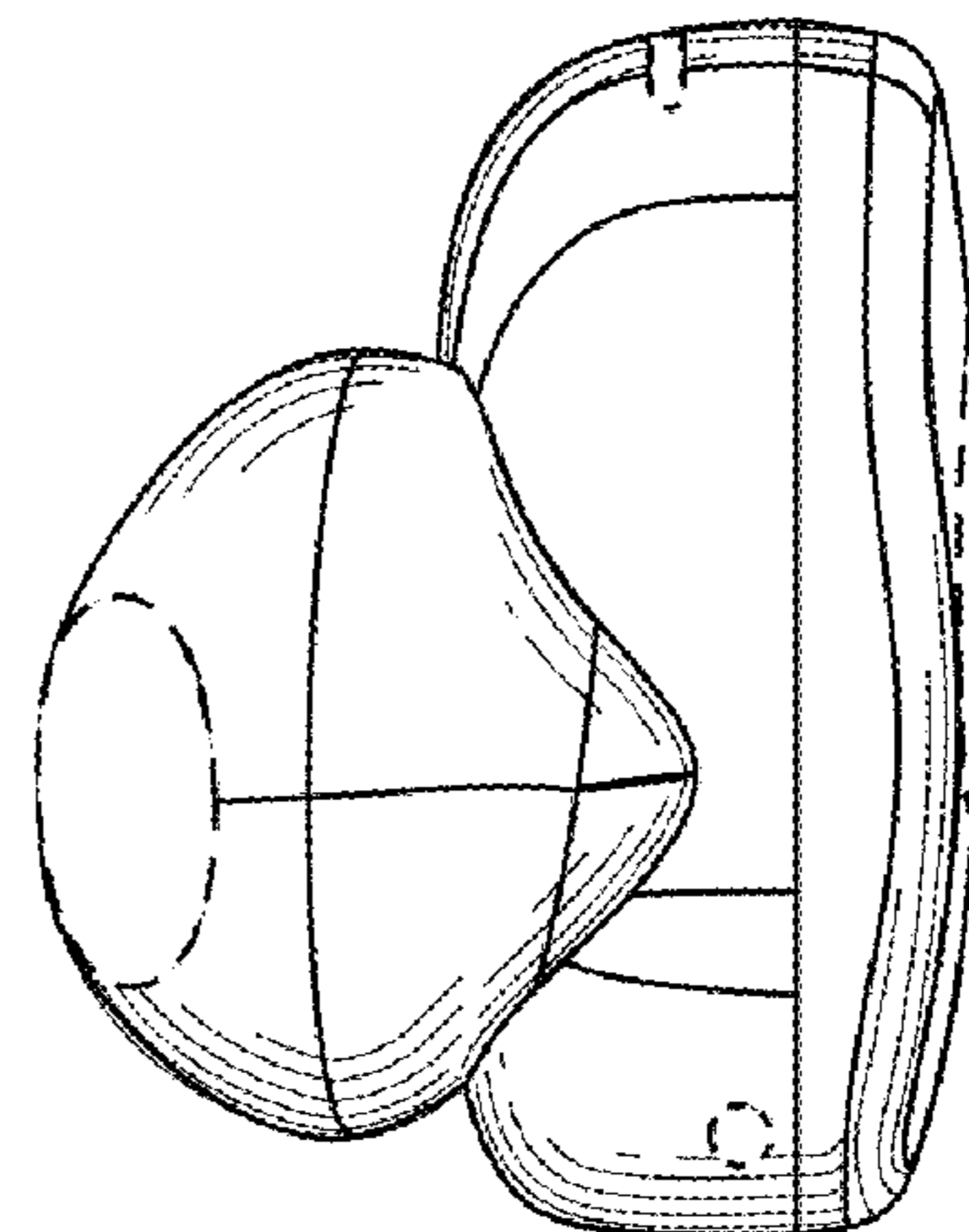
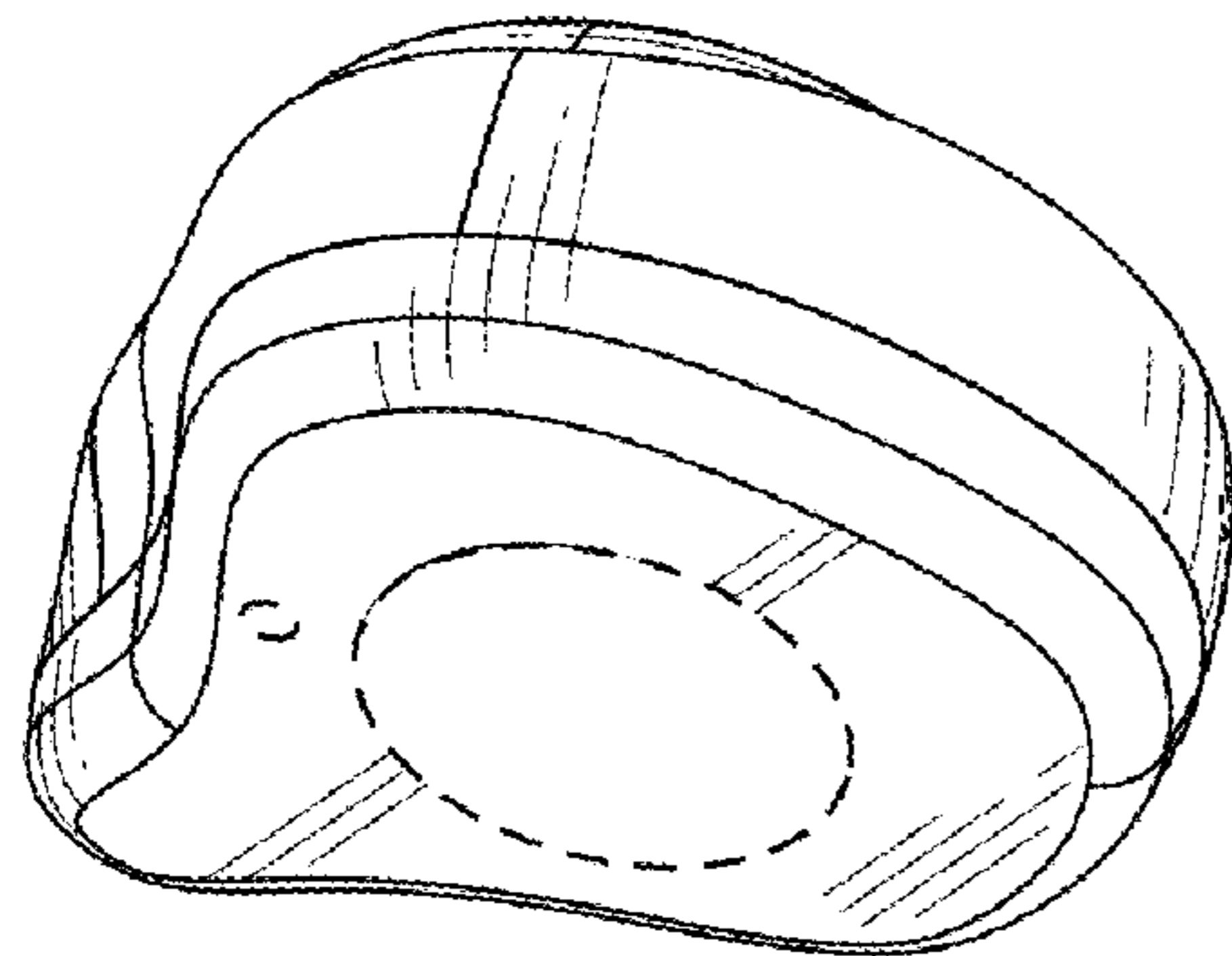

(56)

References Cited

U.S. PATENT DOCUMENTS

D287,280	S *	12/1986	Topholm	D24/174
D287,764	S *	1/1987	Topholm	D24/174
D287,765	S *	1/1987	Topholm	D24/174
D481,709	S *	11/2003	Solderits	D14/223
D482,022	S *	11/2003	Nakano	D14/223
6,728,388	B1 *	4/2004	Nageno	H04R 1/105 381/330
D505,411	S *	5/2005	Sakai	D14/192
D505,415	S *	5/2005	Han	D14/223
D511,768	S *	11/2005	Naito	D14/205
D512,417	S *	12/2005	Hirakawa	D14/223
7,120,267	B2 *	10/2006	Ito	H04M 1/05 381/375
D532,520	S *	11/2006	Kampmeier	D24/174
D542,282	S *	5/2007	Yoshiyama	D14/223
D543,972	S *	6/2007	Taylor	D14/223
D559,837	S *	1/2008	Nakano	D14/223
7,356,362	B2 *	4/2008	Chang	H04R 1/1033 379/430
D568,290	S *	5/2008	Wikel	D14/205
D575,278	S *	8/2008	Guccione	D14/223
D579,006	S *	10/2008	Kim	D14/223
7,492,917	B2 *	2/2009	Ito	H04R 1/10 381/370
D588,111	S *	3/2009	Komiyama	D14/223
D603,380	S *	11/2009	Hutchieson	D14/223
D643,414	S *	8/2011	Lee	D14/205
9,055,369	B2 *	6/2015	Yang	H04R 1/10
D806,879	S *	1/2018	Horbinski	D24/174
D813,848	S *	3/2018	Palmborg	D14/223
D826,211	S *	8/2018	Kim	D14/206

* cited by examiner

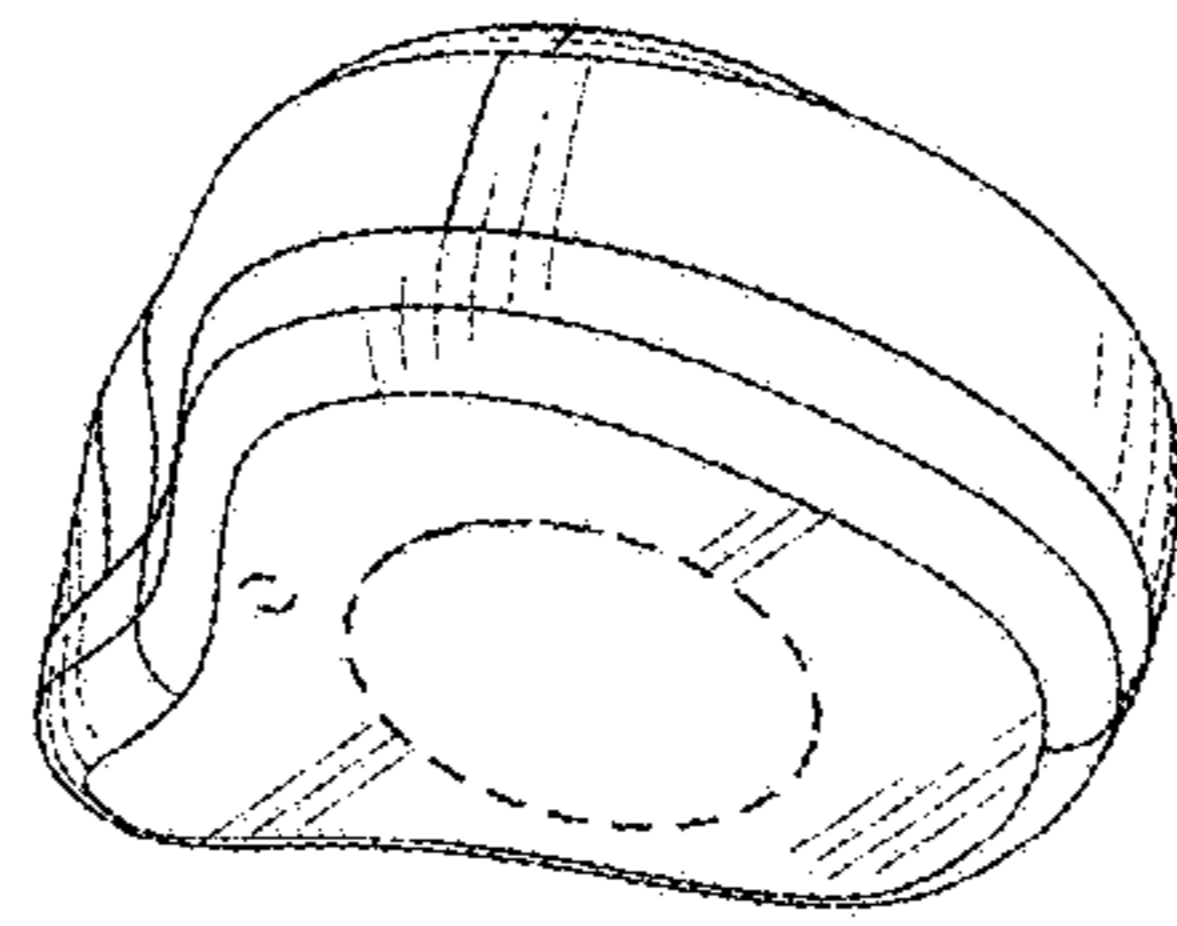

Fig. 1

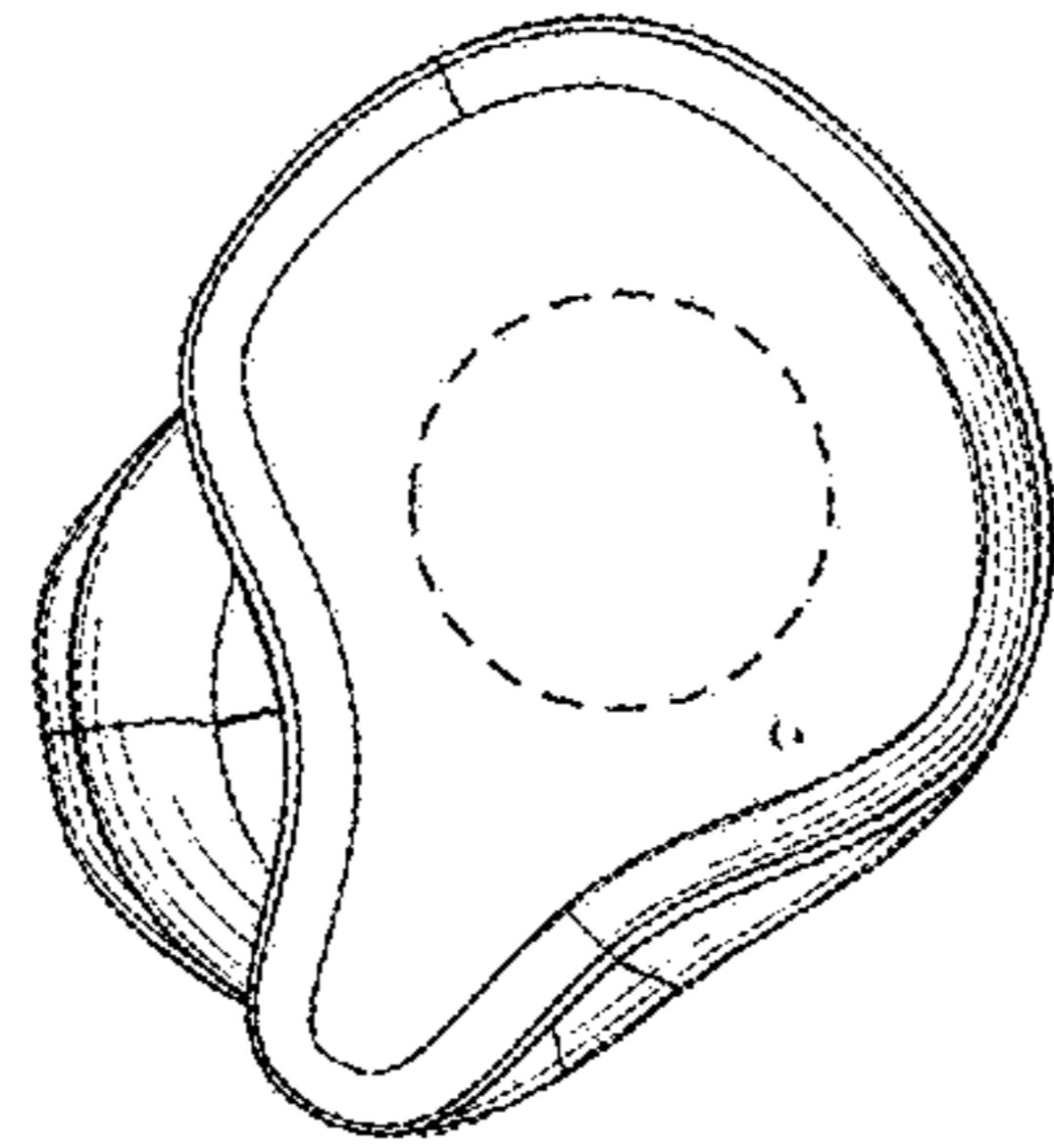

Fig. 2

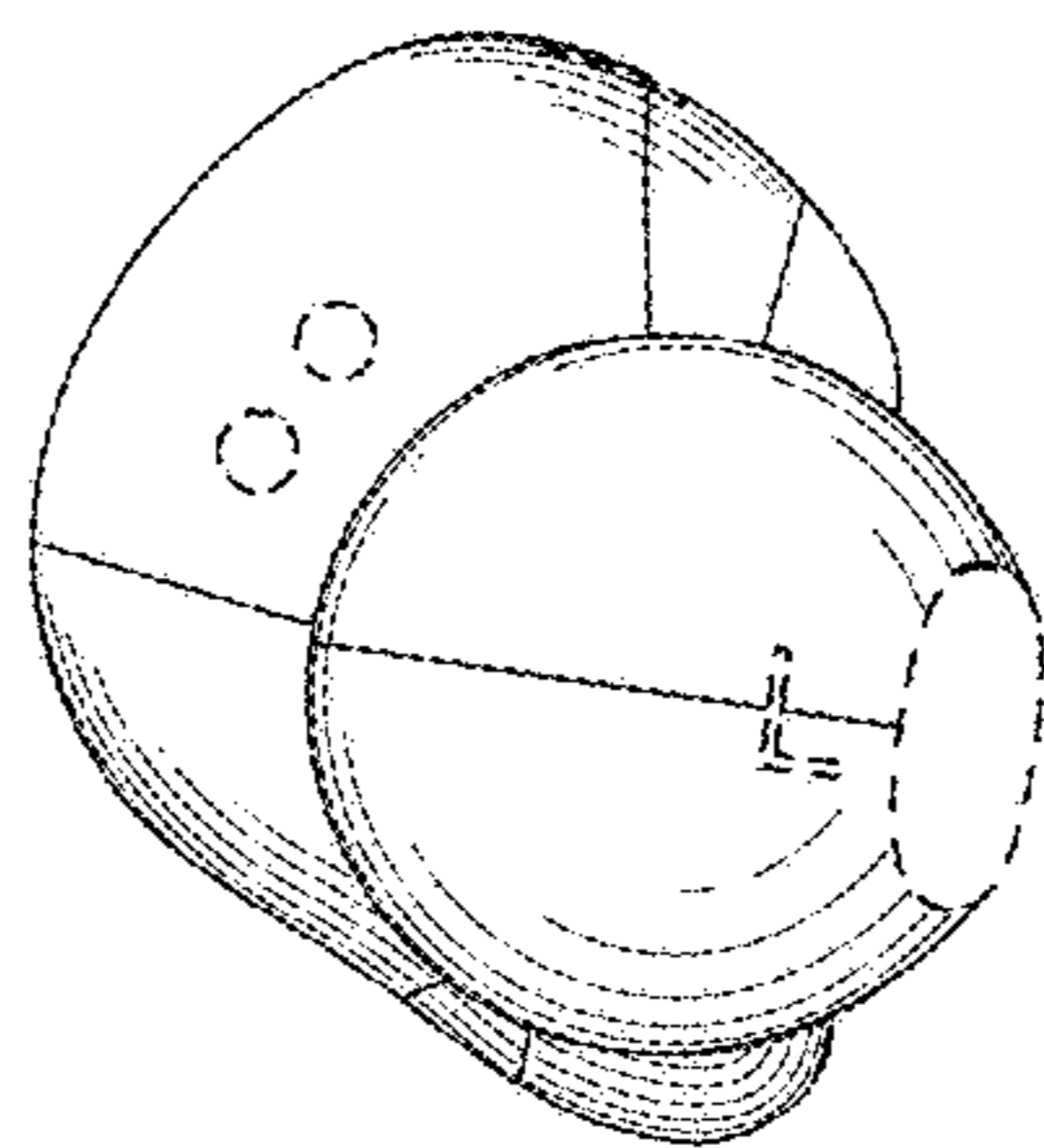

Fig. 3

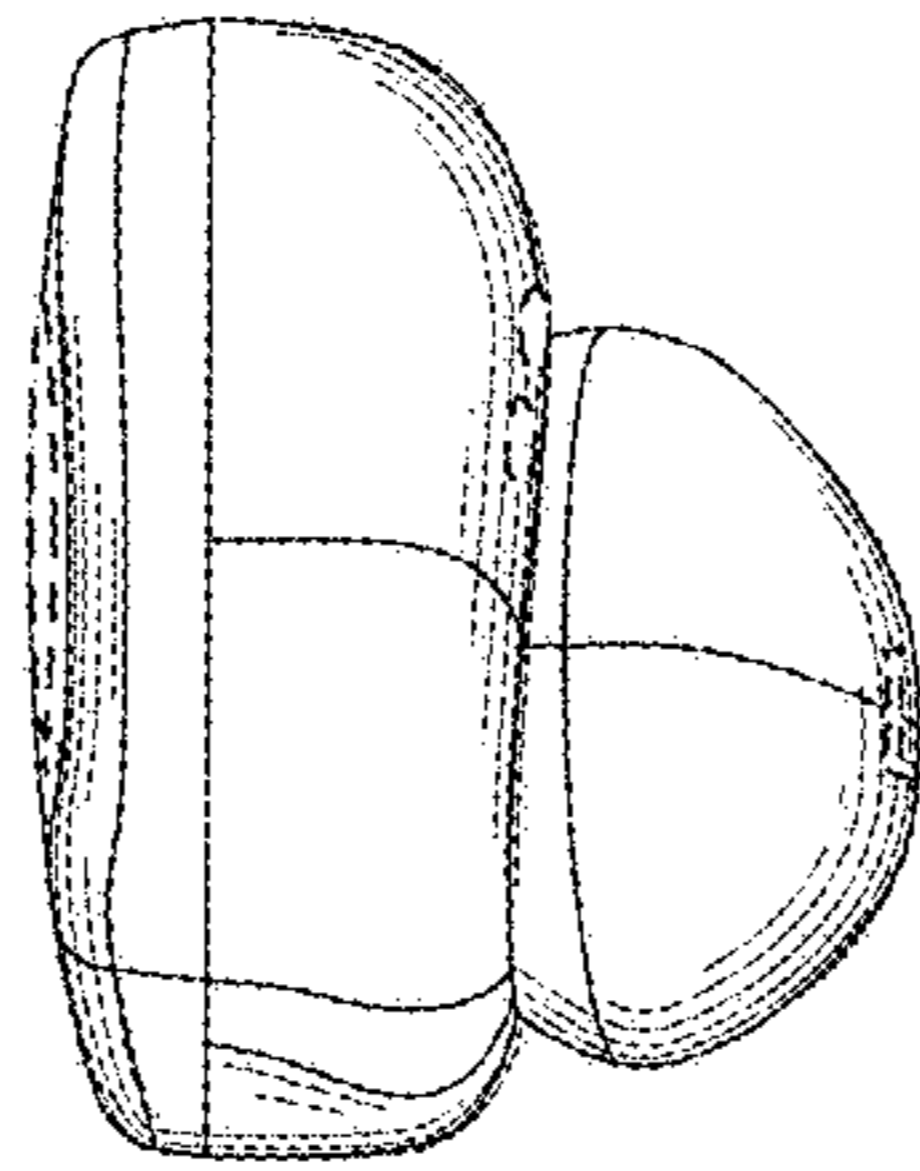

Fig. 4

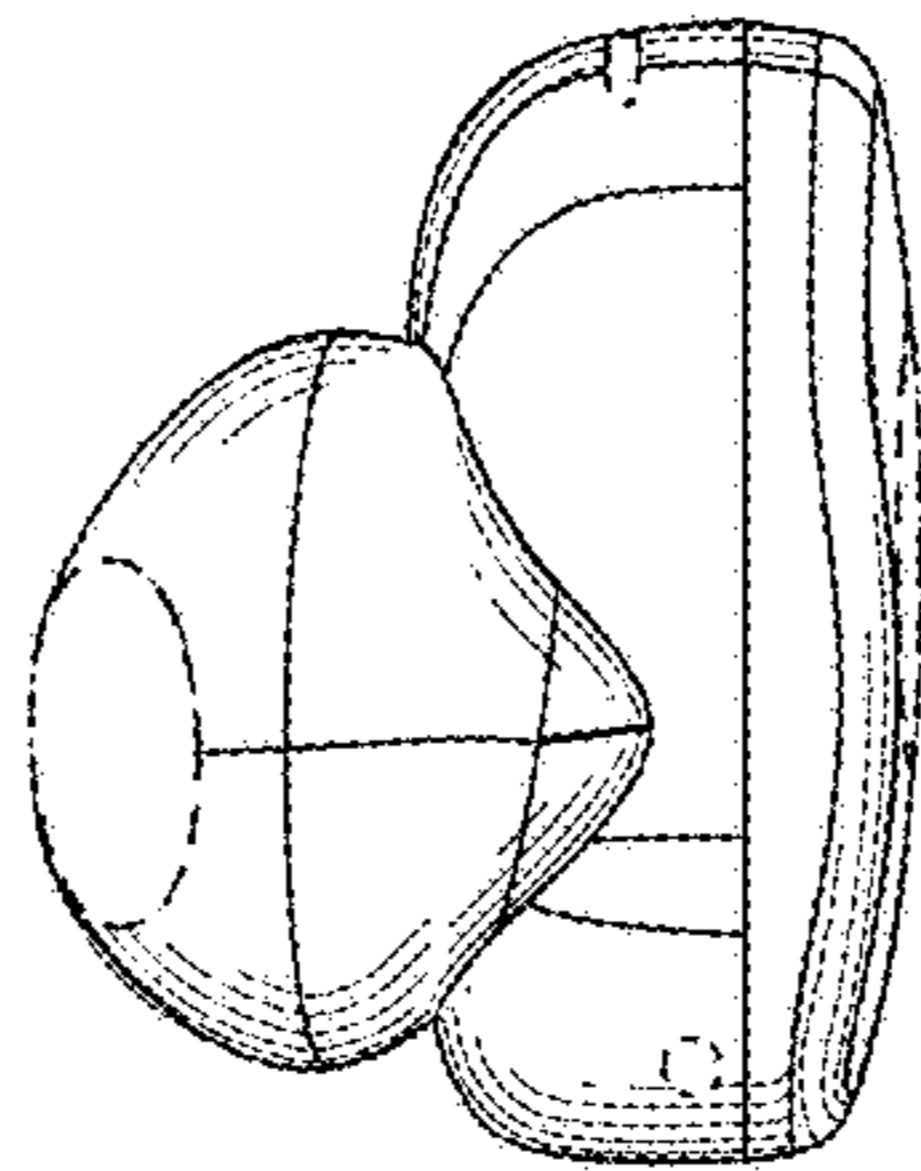

Fig. 5

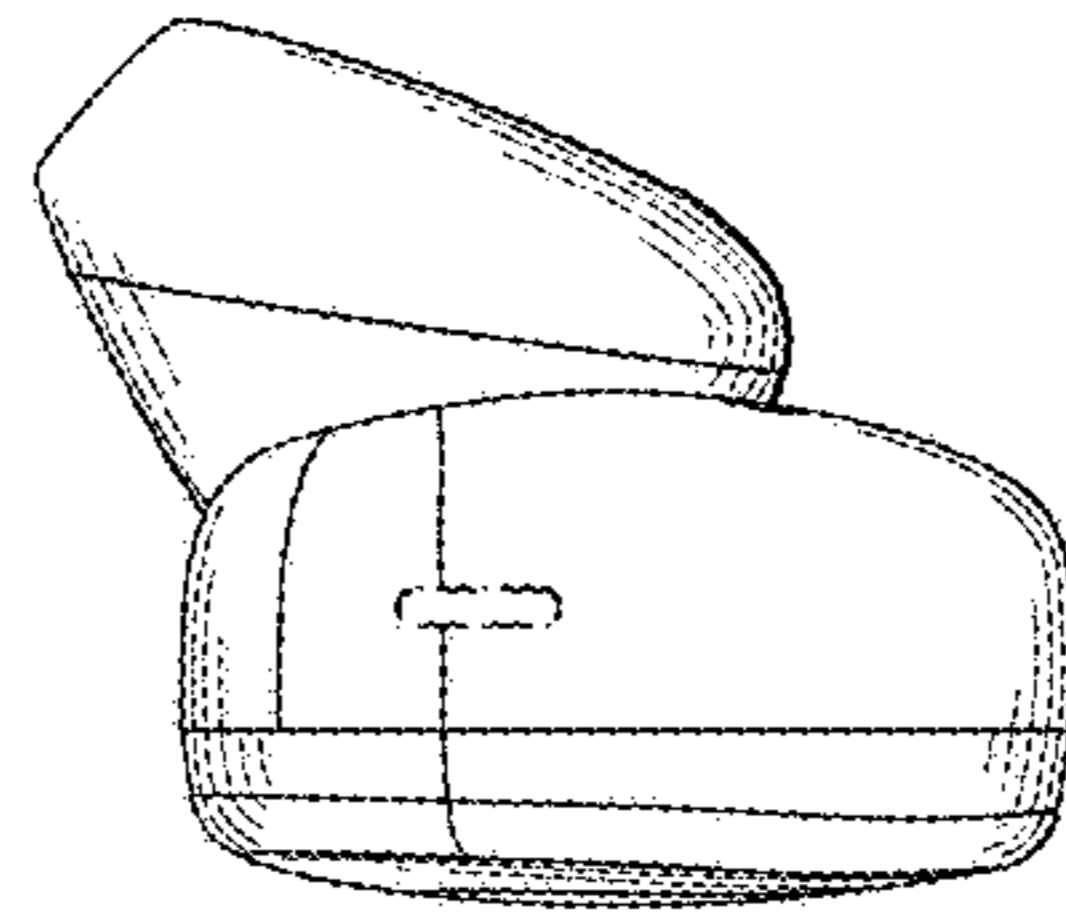

Fig. 6

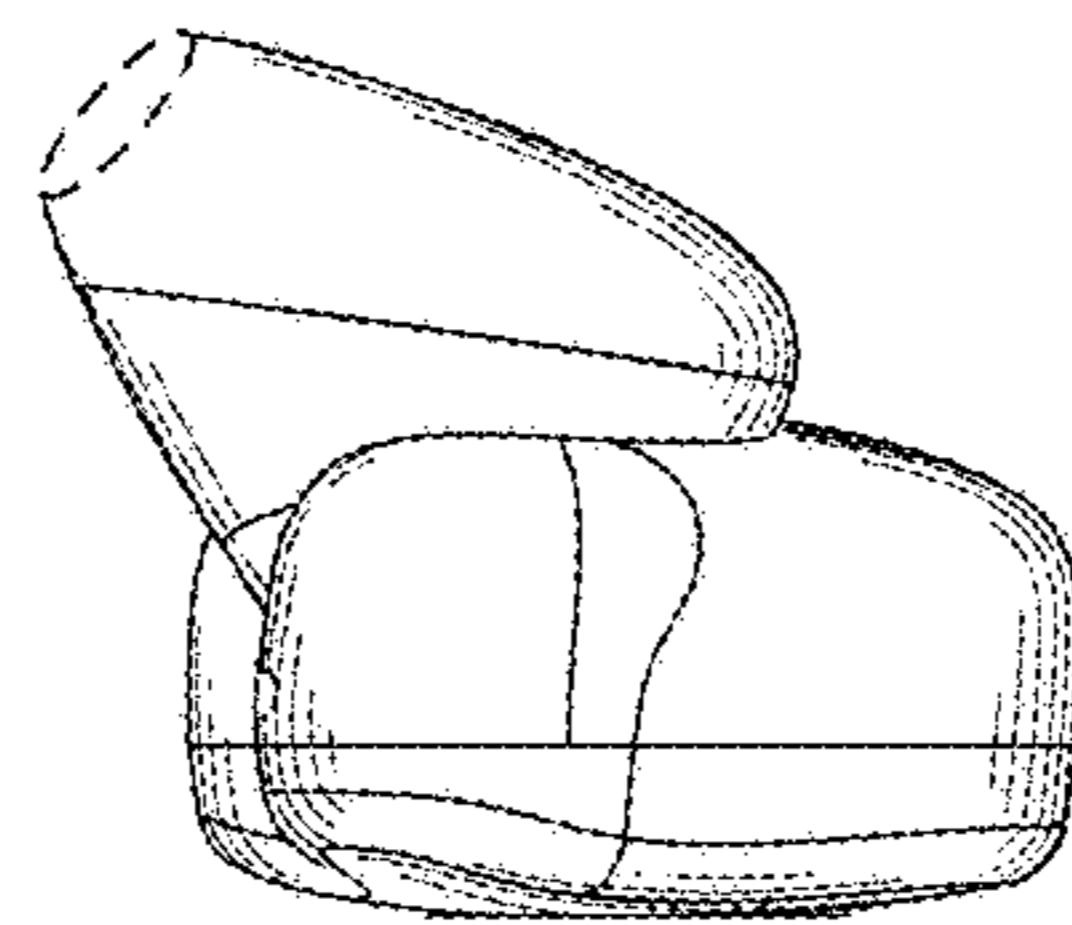

Fig. 7

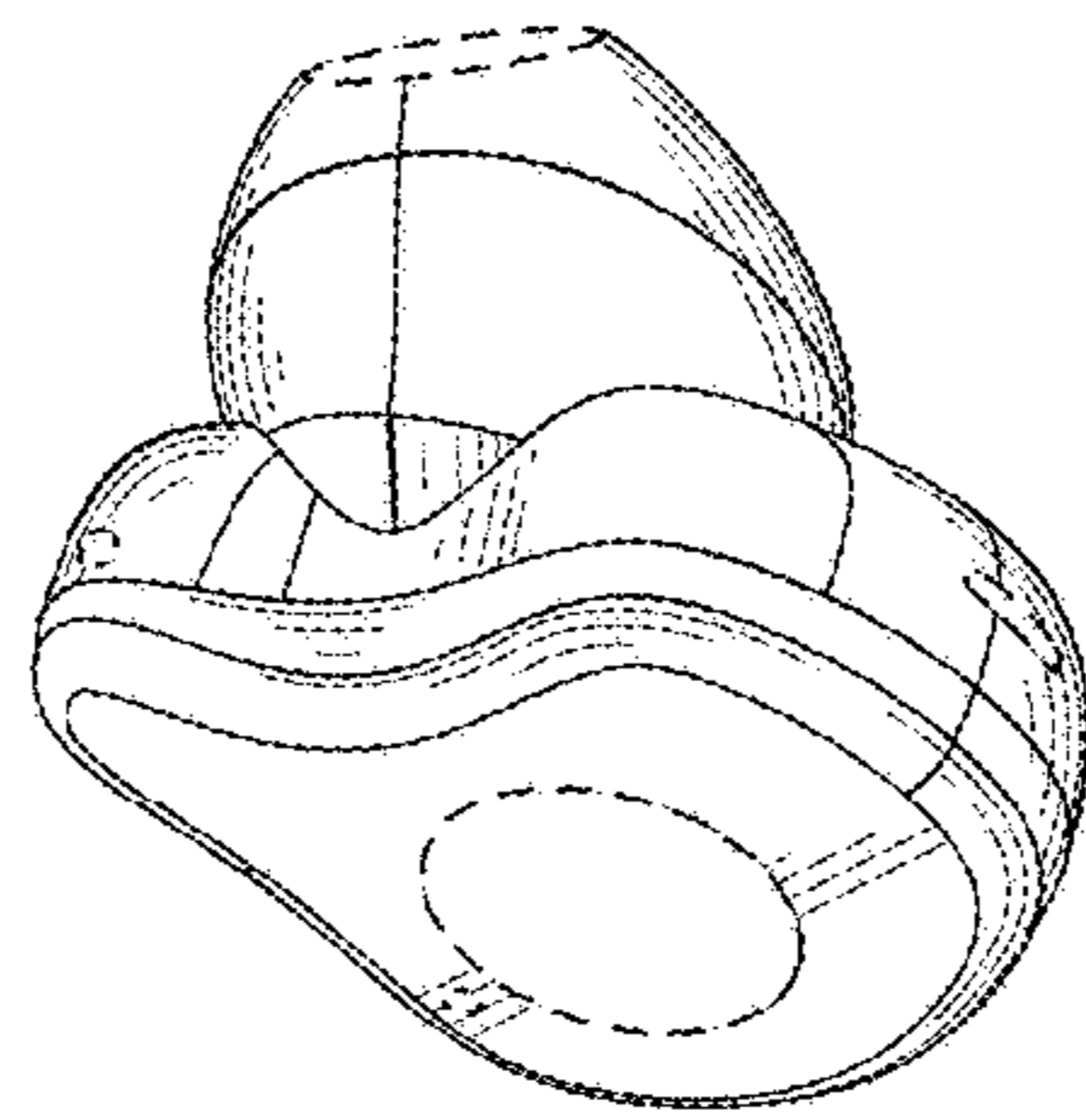

Fig. 8

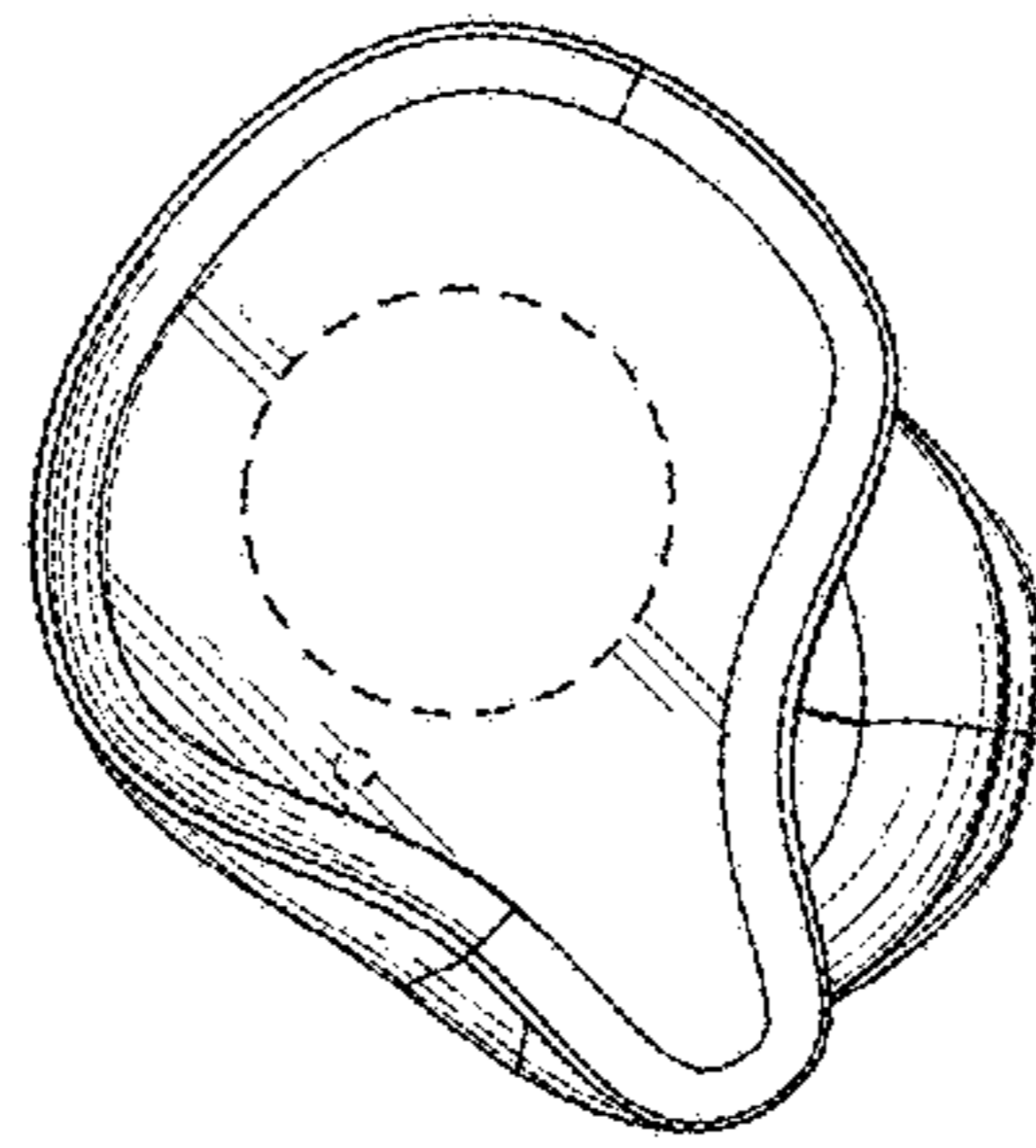

Fig. 9

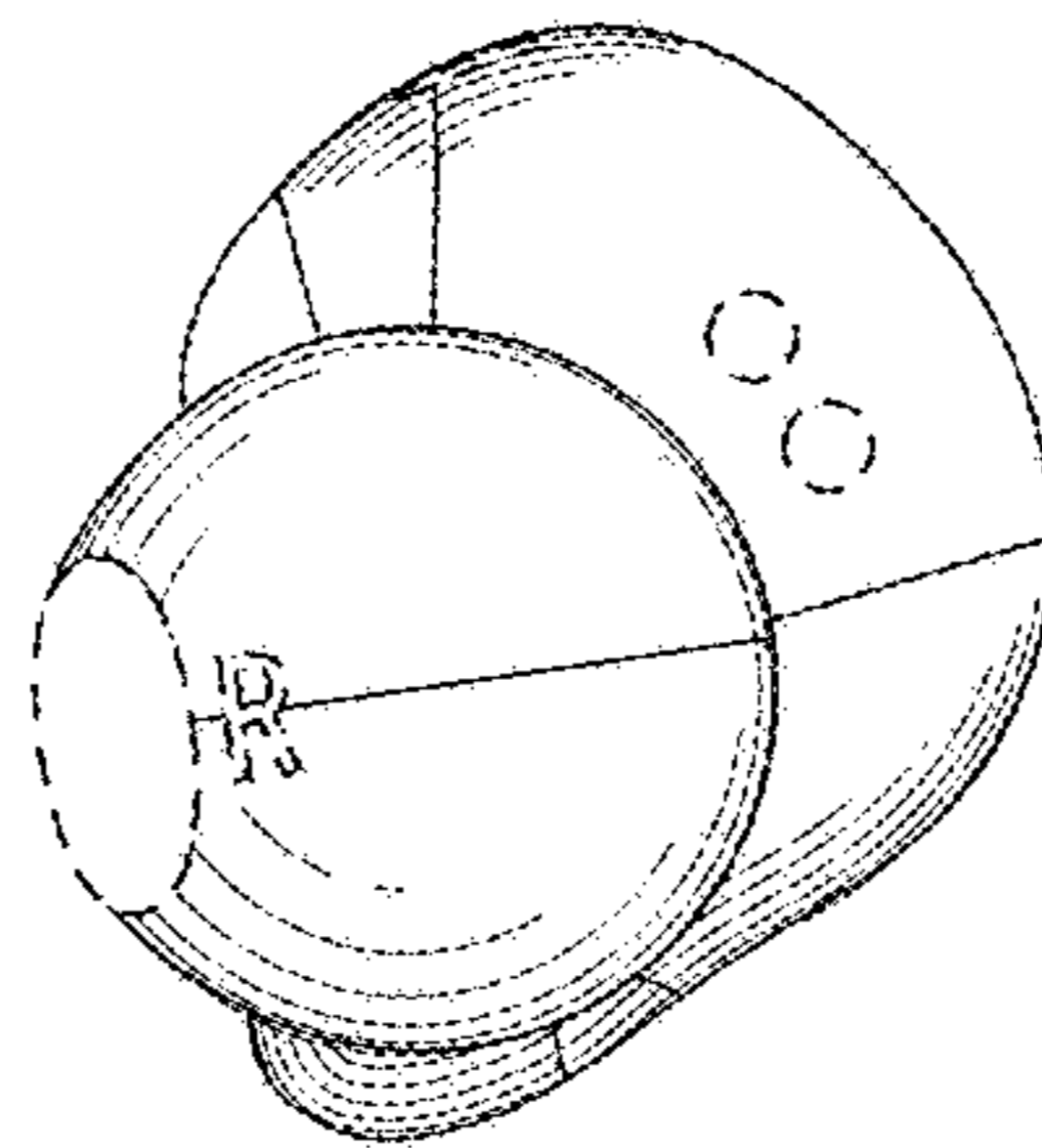

Fig. 10

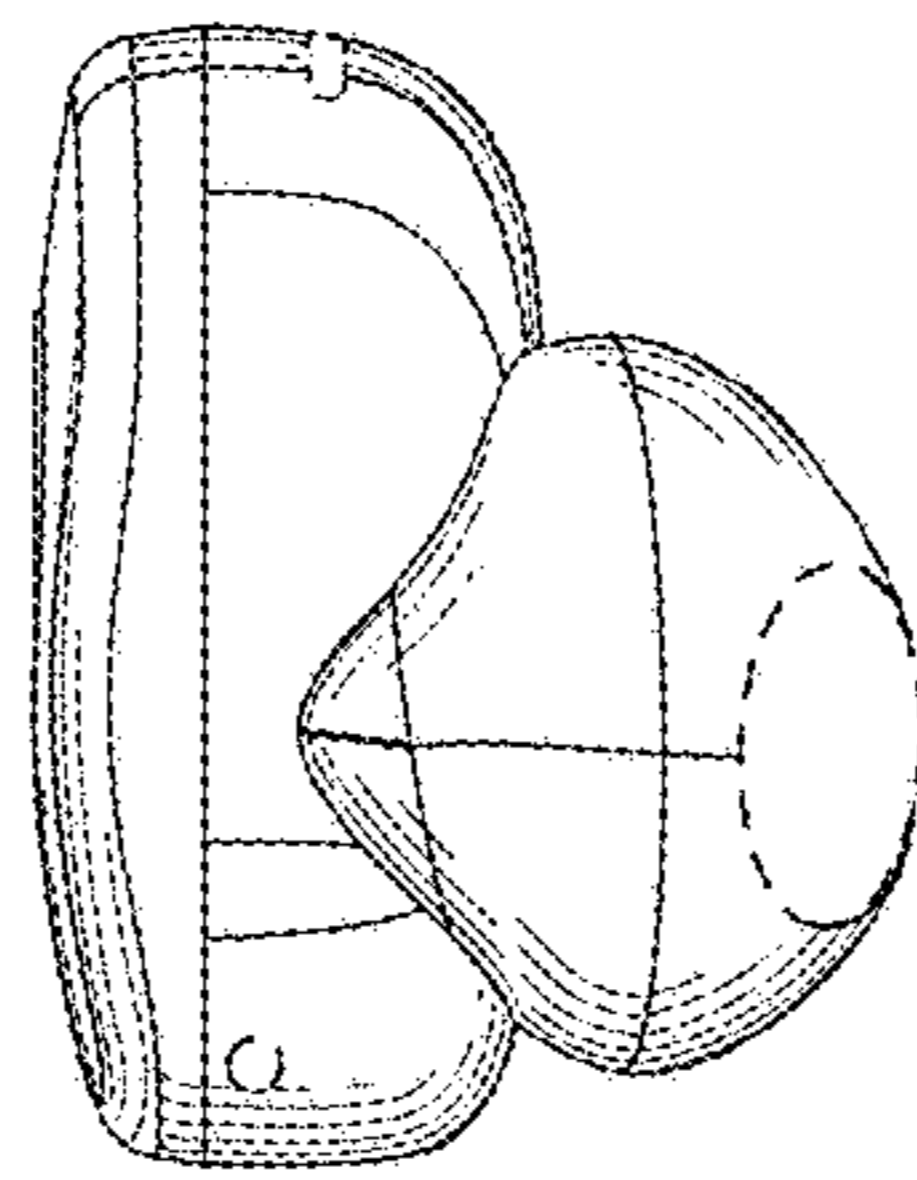

Fig. 11

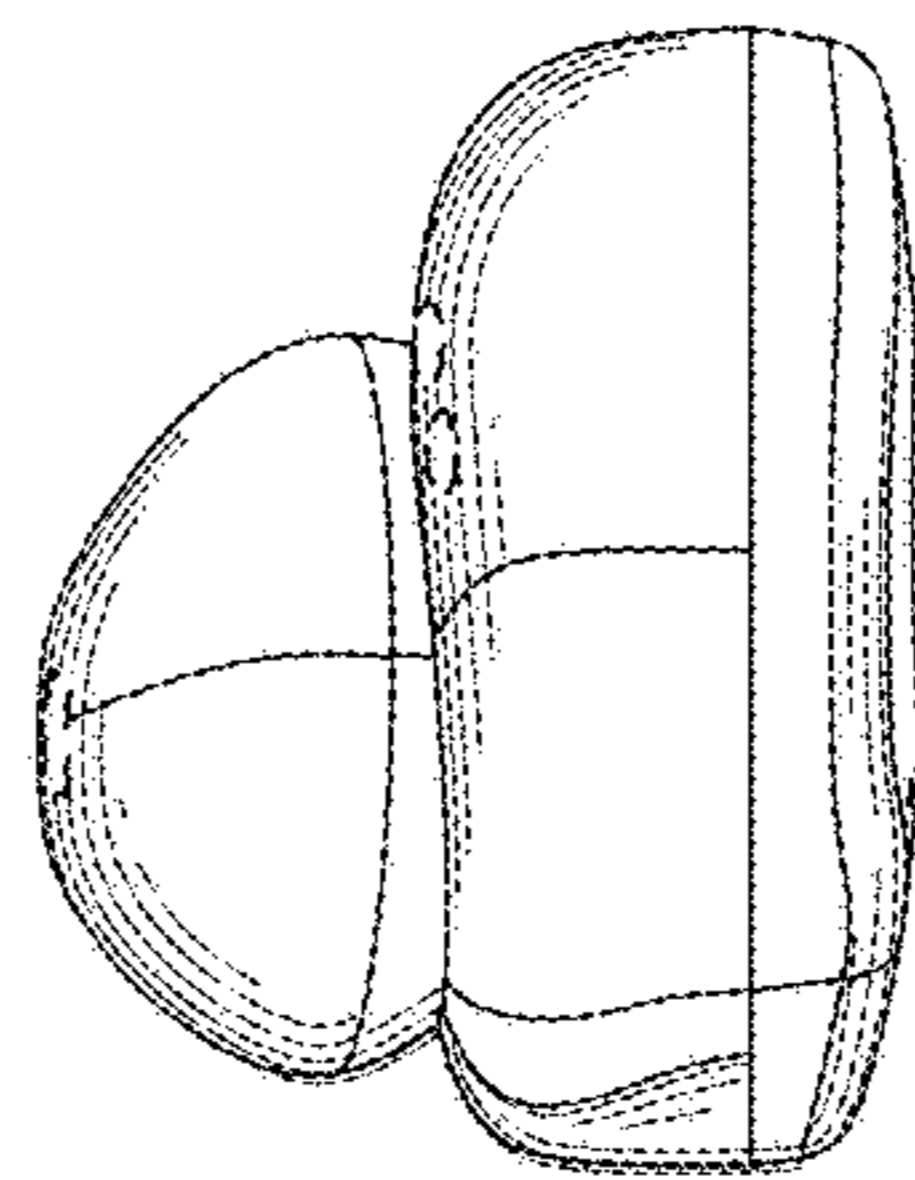

Fig. 12

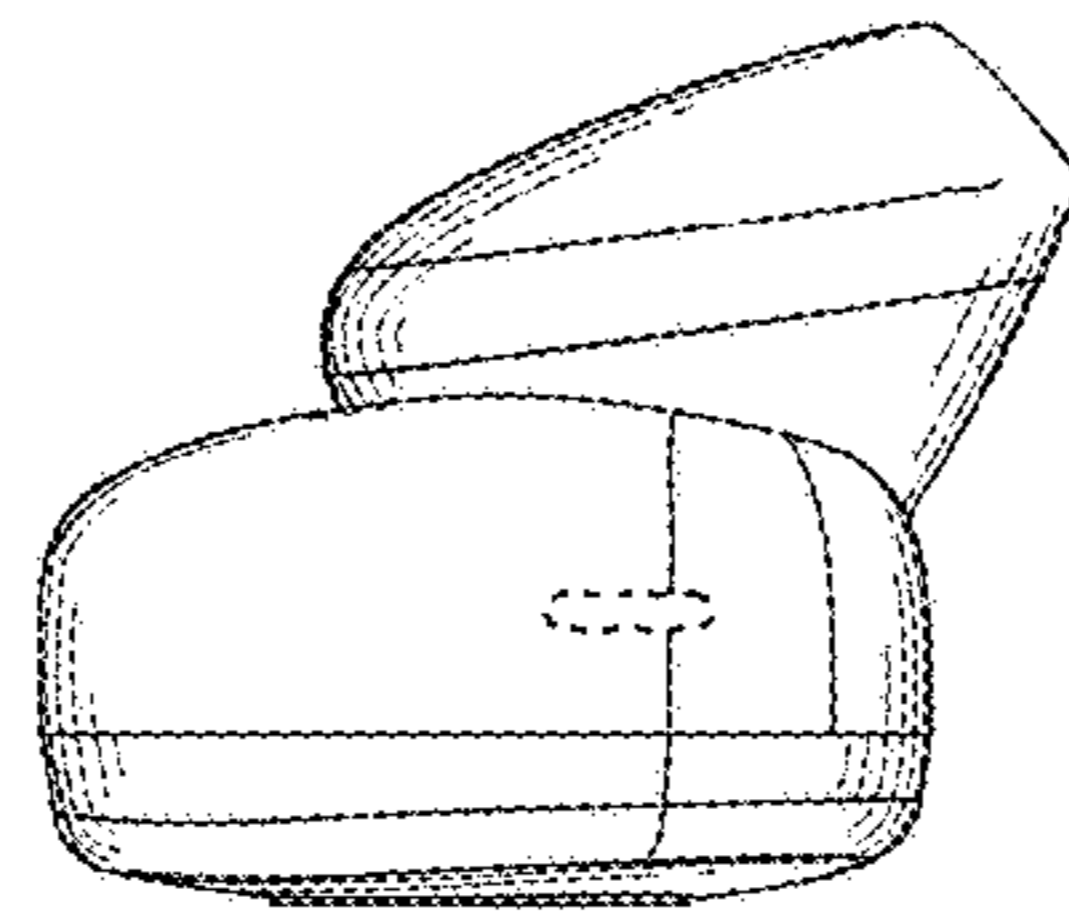

Fig. 13

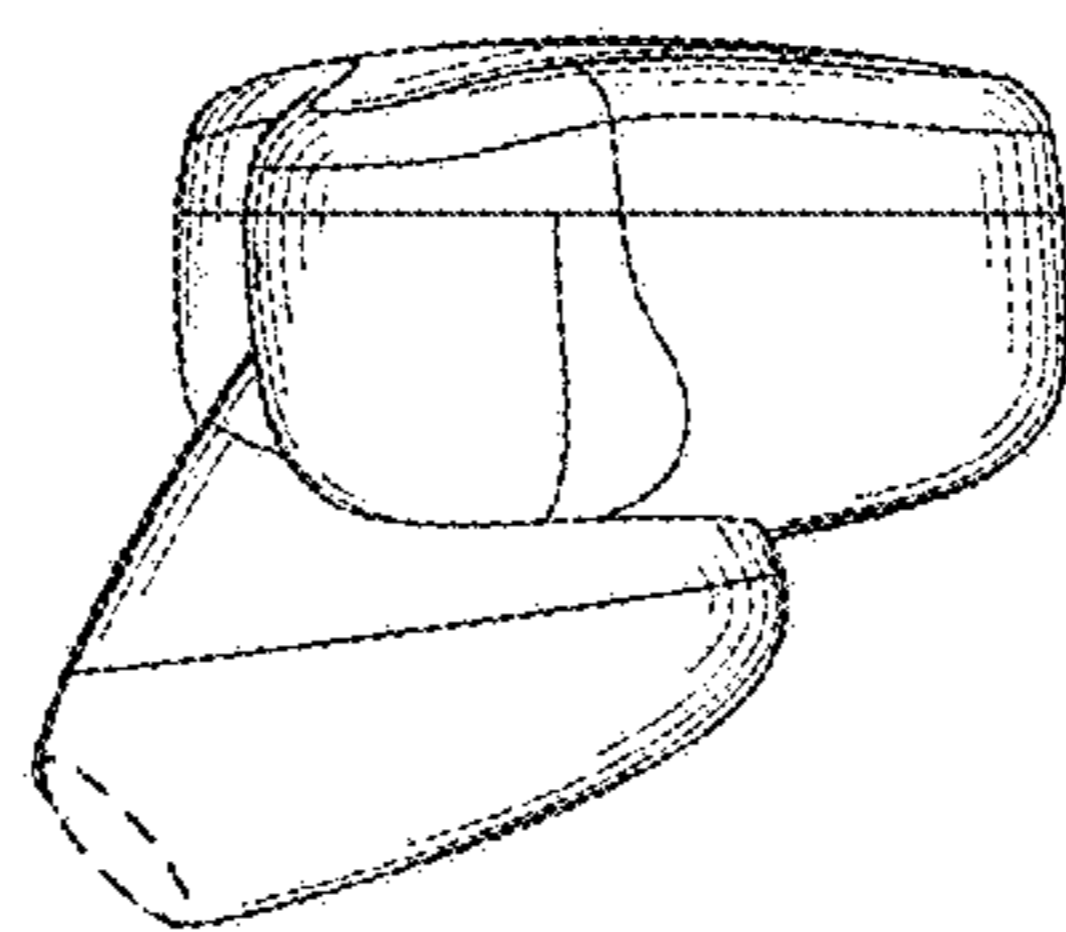

Fig. 14

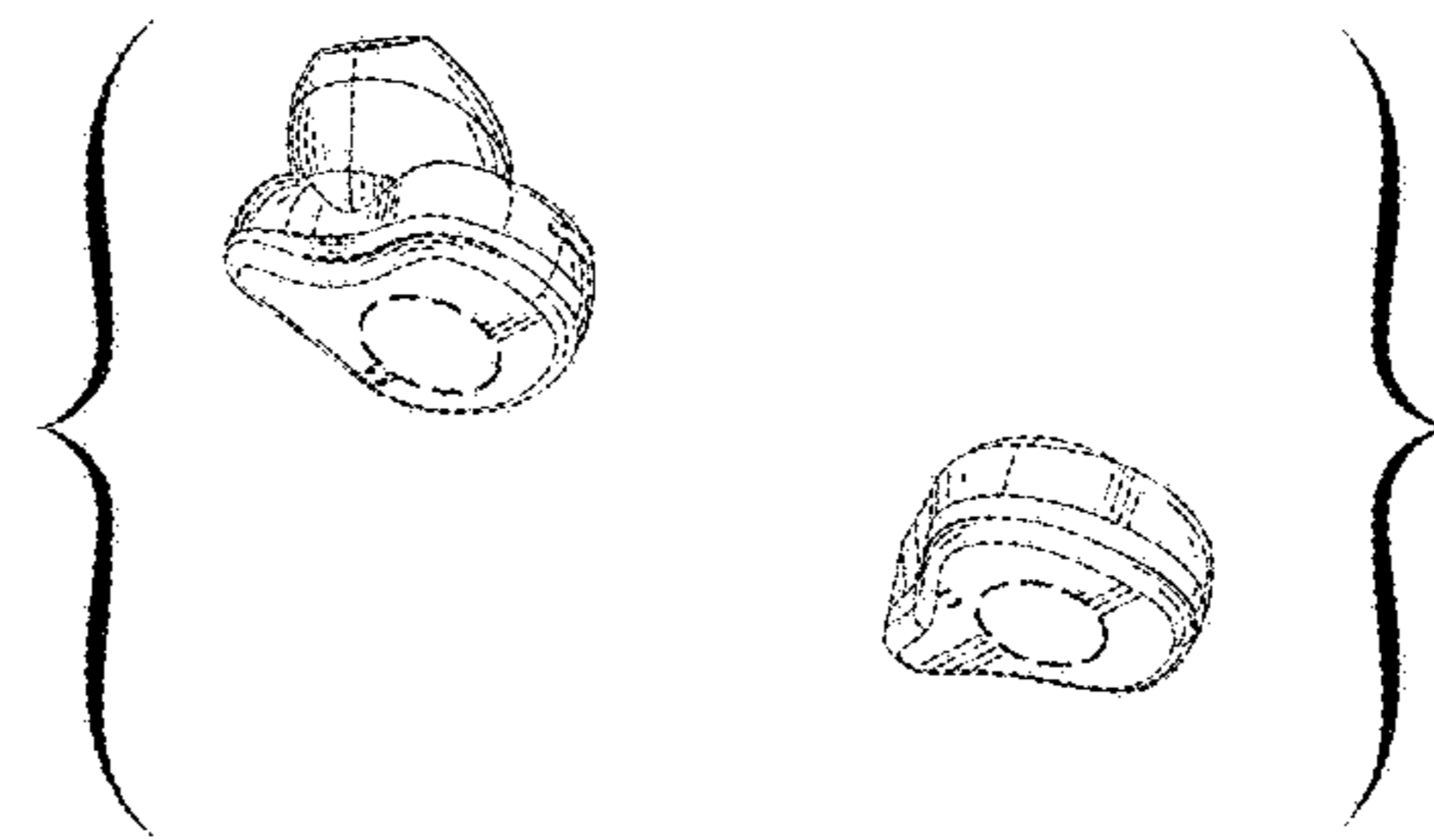

Fig. 15

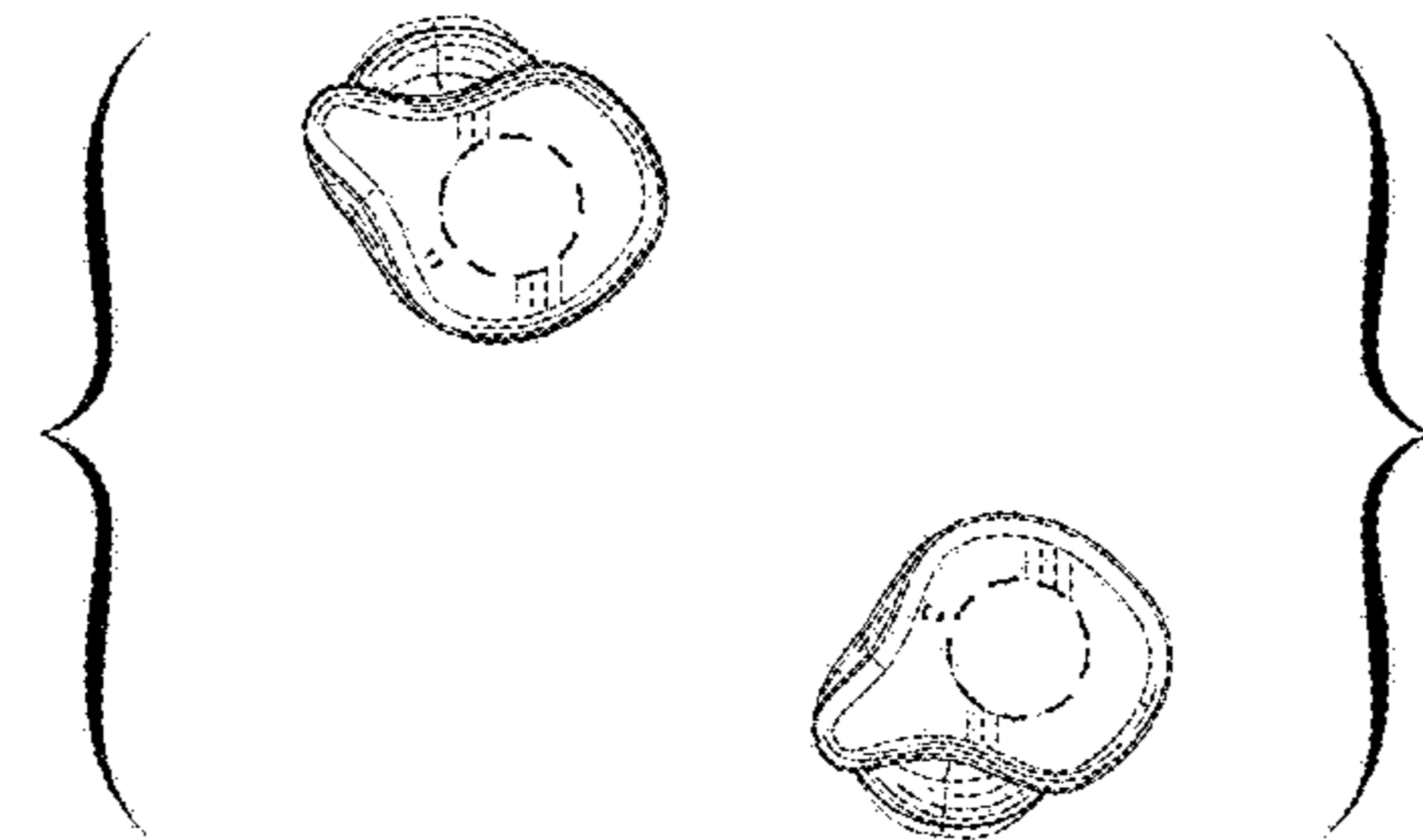

Fig. 16

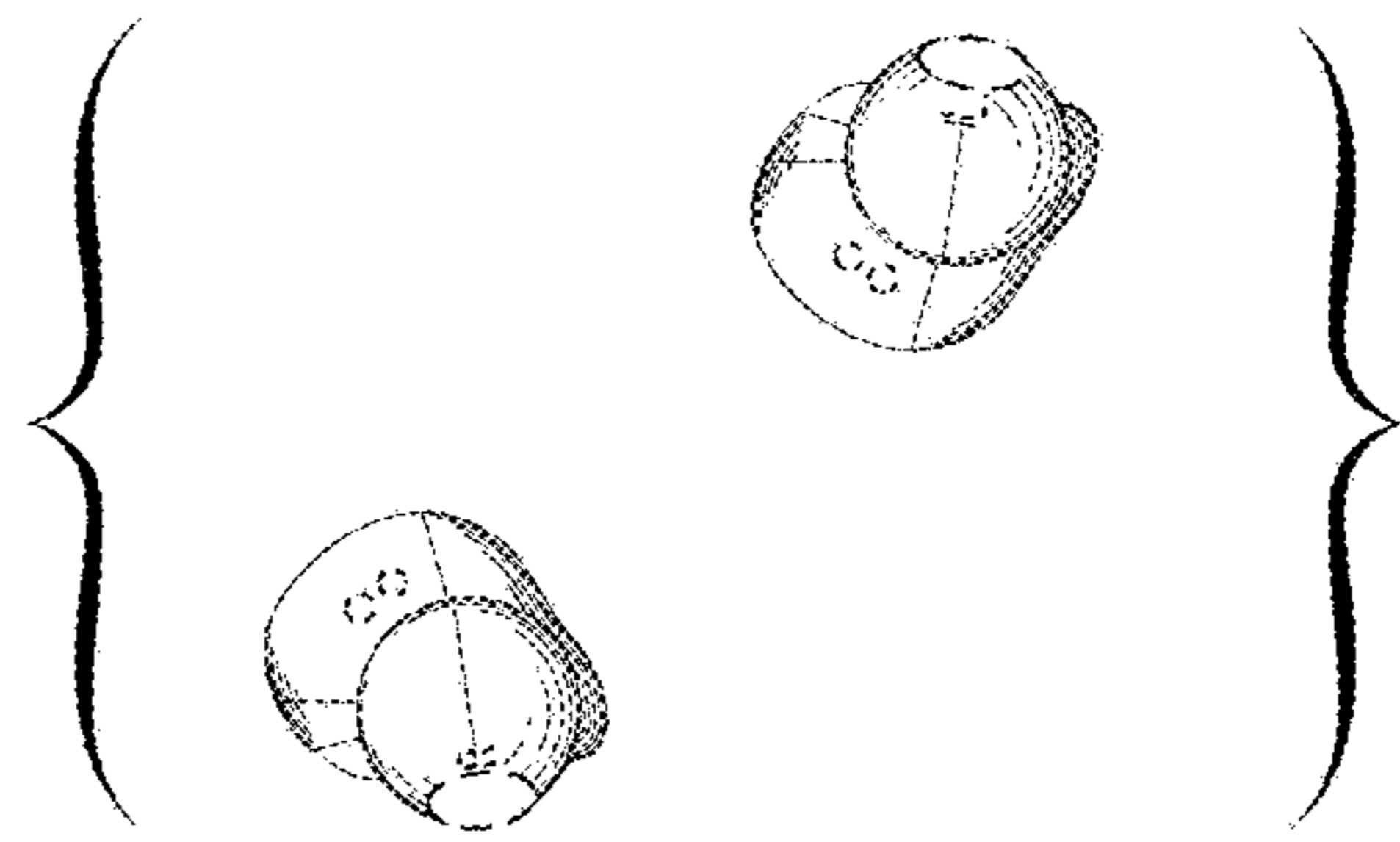

Fig. 17

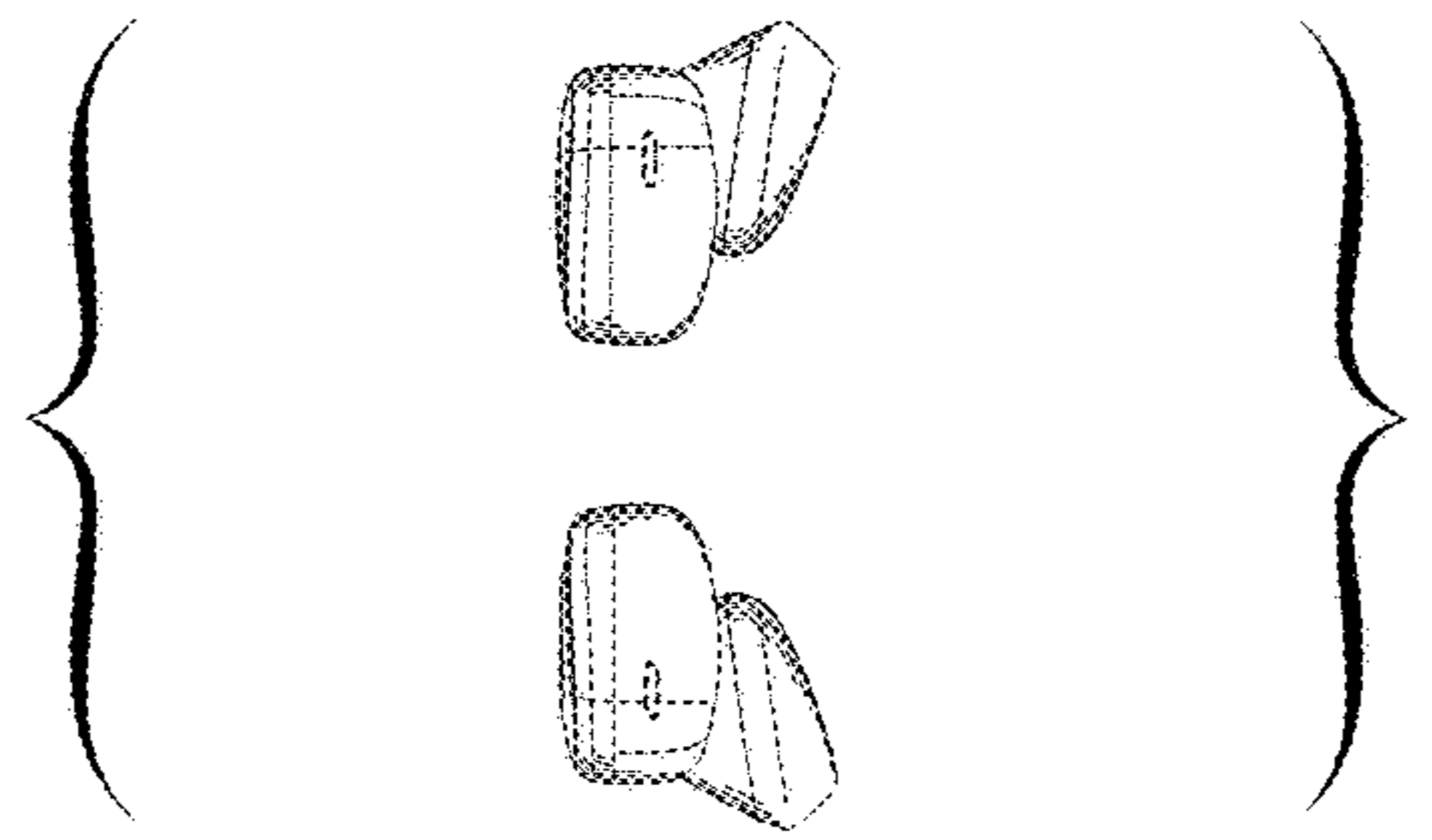

Fig. 18

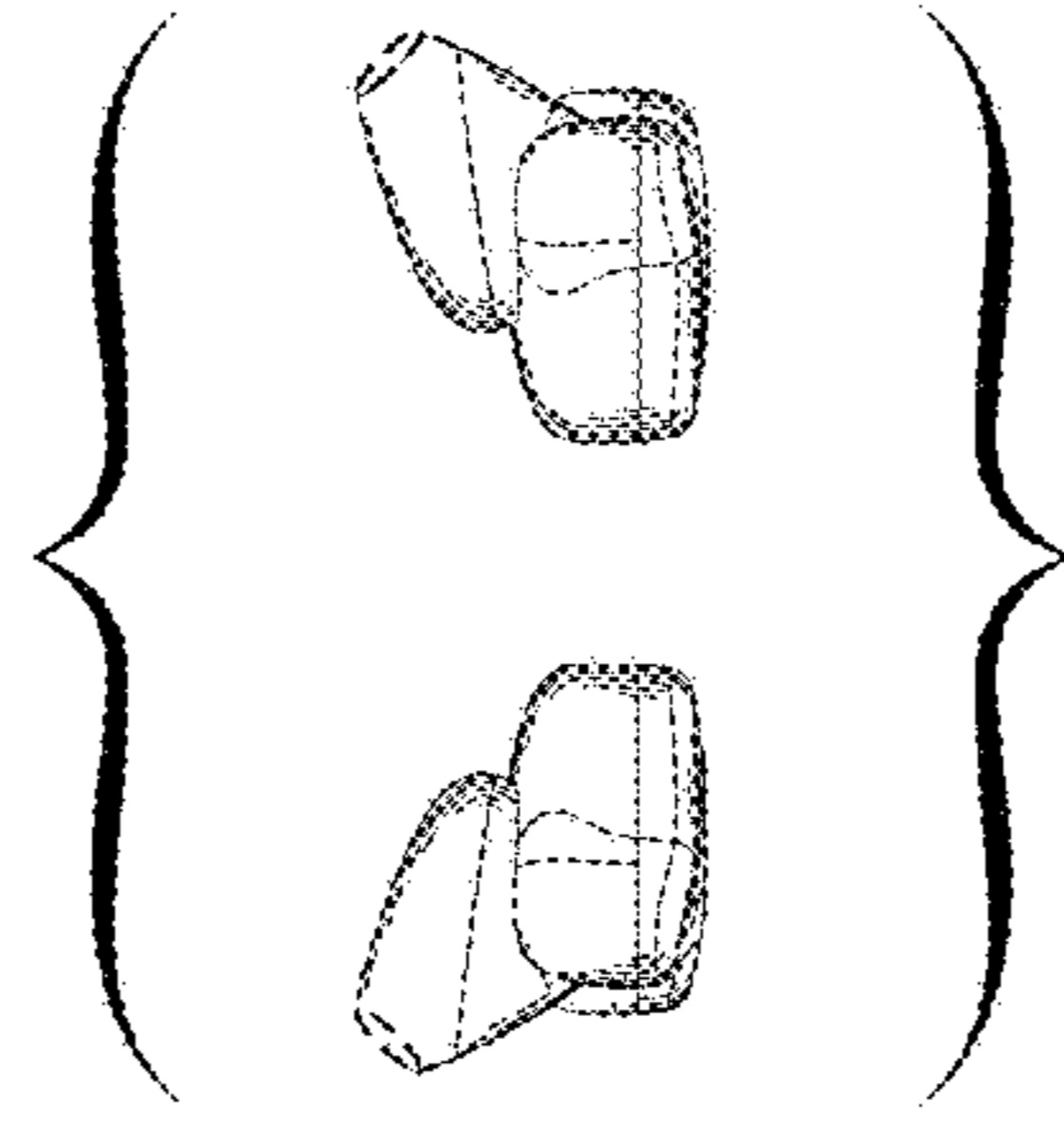

Fig. 19

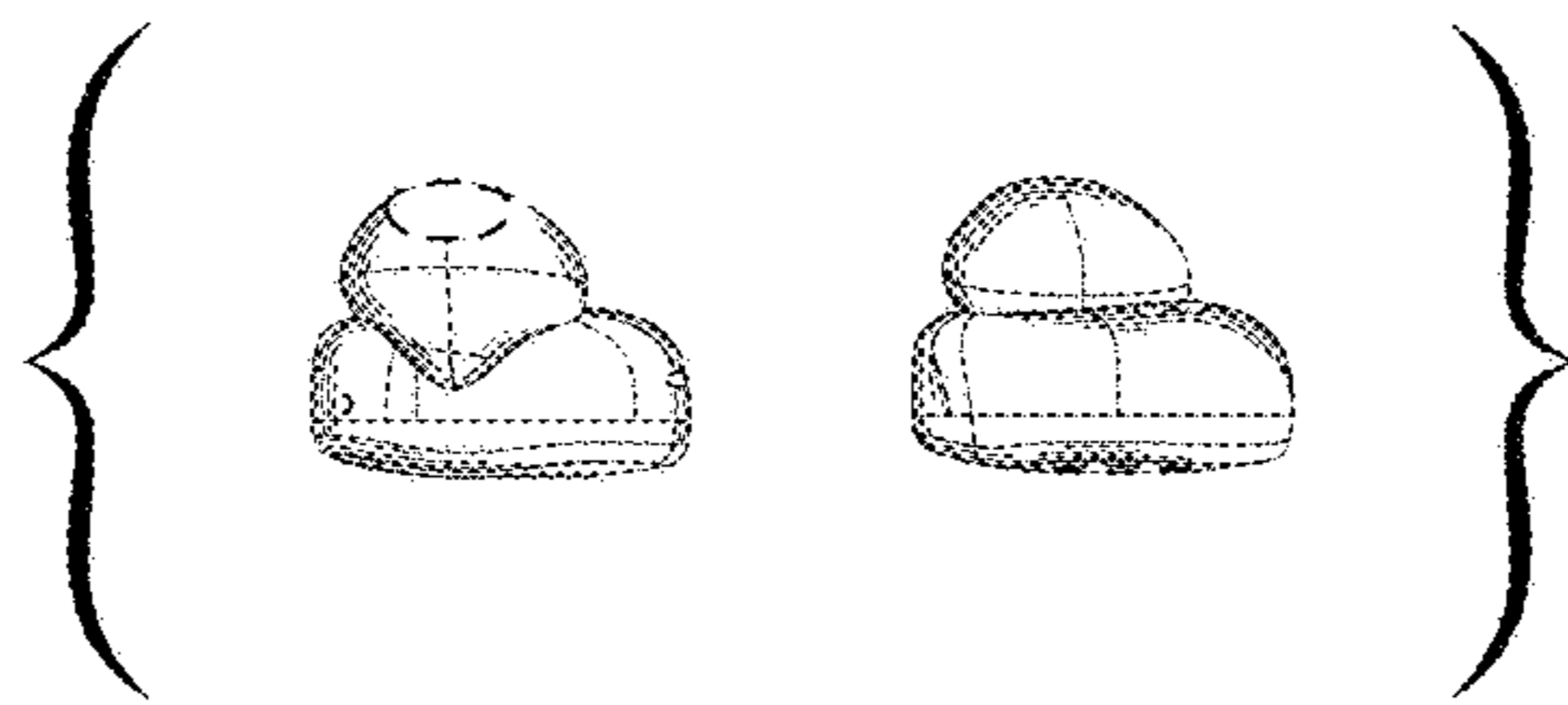

Fig. 20

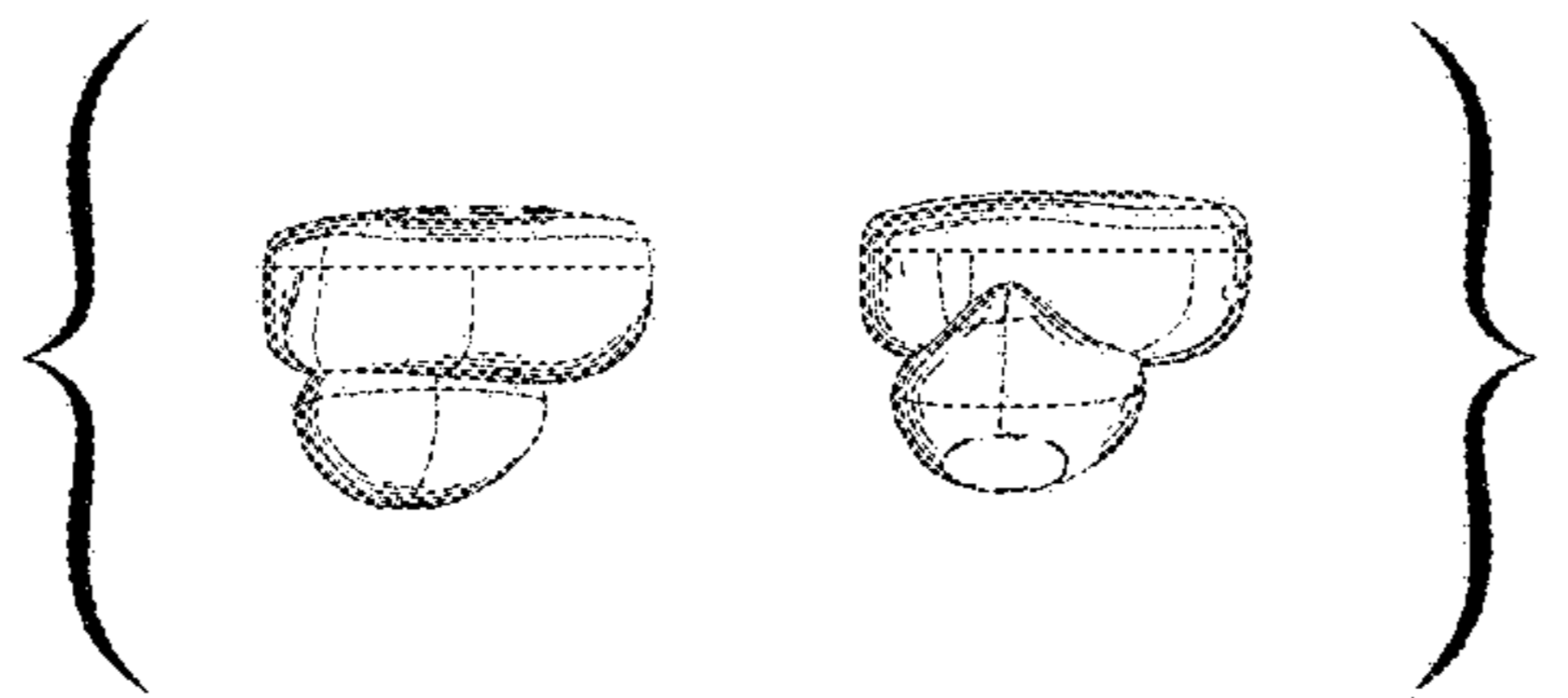

Fig. 21