



US00D863146S

(12) **United States Design Patent** (10) **Patent No.:** **US D863,146 S**
Frascella et al. (45) **Date of Patent:** **** Oct. 15, 2019**

- (54) **REAR END OF A VEHICLE**
- (71) Applicant: **Jaguar Land Rover Limited**, Whitley, Coventry (GB)
- (72) Inventors: **Massimo Frascella**, Coventry (GB); **Andrew Wheel**, Coventry (GB)
- (73) Assignee: **Jaguar Land Rover Limited**, Whitley, Coventry (GB)
- (**) Term: **15 Years**
- (21) Appl. No.: **29/677,905**
- (22) Filed: **Jan. 24, 2019**

Related U.S. Application Data

- (62) Division of application No. 29/603,400, filed on May 9, 2017, now Pat. No. Des. 840,290.

(30) **Foreign Application Priority Data**

Nov. 11, 2016 (EM) 003459551-0008
 Nov. 11, 2016 (EM) 003459551-0009

- (51) **LOC (12) Cl.** **12-16**

- (52) **U.S. Cl.**
USPC **D12/164**

- (58) **Field of Classification Search**
USPC D12/90-92, 86, 196, 163, 164, 169;
293/102, 113, 115, 117, 120; 296/180.1,
296/180.2; 280/181.1, 181.5
CPC B62D 35/00; B62D 25/00; B62D 25/06;
B62D 33/00
See application file for complete search history.

(56) **References Cited**

U.S. PATENT DOCUMENTS

D717,698 S * 11/2014 Beaven D12/92
 D736,127 S * 8/2015 Hammoud D12/169

D738,268 S * 9/2015 Blanski D12/169
 D740,177 S * 10/2015 Callum D12/92
 D741,226 S * 10/2015 Callum D12/92
 D744,902 S * 12/2015 Callum D12/92
 D744,903 S * 12/2015 Jelec D12/92
 D746,188 S * 12/2015 Nakagawa D12/169
 D748,535 S * 2/2016 Hatton D12/92
 D763,141 S * 8/2016 Lesnik D12/164
 D763,743 S * 8/2016 Hatton D12/164
 D769,780 S * 10/2016 Lesnik D12/164
 D780,076 S * 2/2017 Peat D12/164
 D783,468 S * 4/2017 Patel D12/164
 D784,864 S * 4/2017 Patel D12/169
 D784,865 S * 4/2017 Peat D12/169
 D800,031 S * 10/2017 Jung D12/169

(Continued)

Primary Examiner — Melody N Brown

(74) *Attorney, Agent, or Firm* — Wood Herron & Evans LLP

(57) **CLAIM**

The ornamental design for a rear end of a vehicle, as shown and described.

DESCRIPTION

FIG. 1 is a right, front perspective view of a rear end of a vehicle showing our new design;
 FIG. 2 is a left, front perspective view thereof;
 FIG. 3 is a left, rear perspective view thereof;
 FIG. 4 is a right, rear perspective view thereof;
 FIG. 5 is a front view thereof;
 FIG. 6 is a right side view thereof;
 FIG. 7 is a left side view thereof; and,
 FIG. 8 is a top view thereof.

The portions of the vehicle shown throughout the drawing views in de-emphasized and half-tone portions outside the broken lines and the broken lines representing the boundary and configuration of what is claimed as the design are for environmental and illustrative purposes only and form no part of the claimed design.

1 Claim, 8 Drawing Sheets

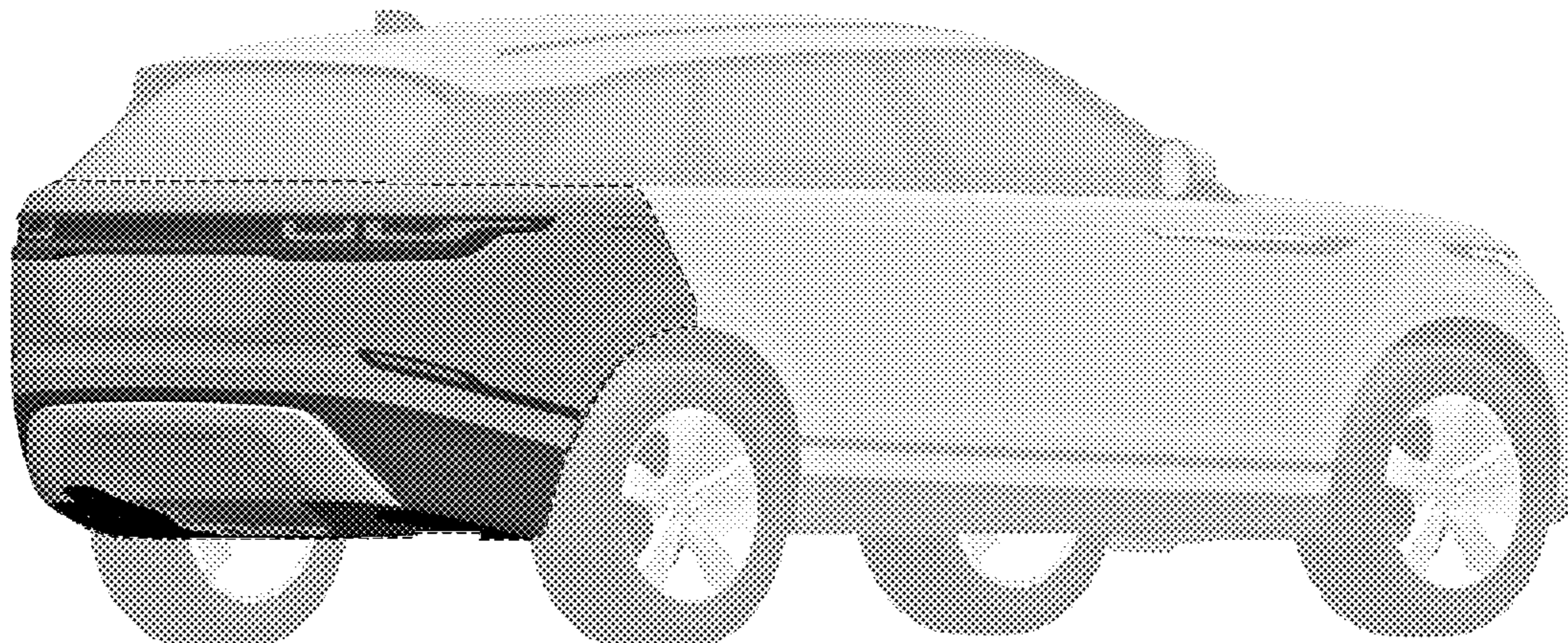

(56)

References Cited

U.S. PATENT DOCUMENTS

D807,245 S *	1/2018	Patel	D12/164
D807,258 S *	1/2018	Patel	D12/169
D808,871 S *	1/2018	Peat	D12/169
D826,113 S *	8/2018	Kanai	D12/169
D833,343 S *	11/2018	Patel	D12/169
D834,472 S *	11/2018	Peat	D12/169
D839,146 S *	1/2019	Patel	D12/164
D840,920 S *	2/2019	Fletcher	D13/101
D841,535 S *	2/2019	Buckingham	D12/169
D842,772 S *	3/2019	Battams	D12/169

* cited by examiner

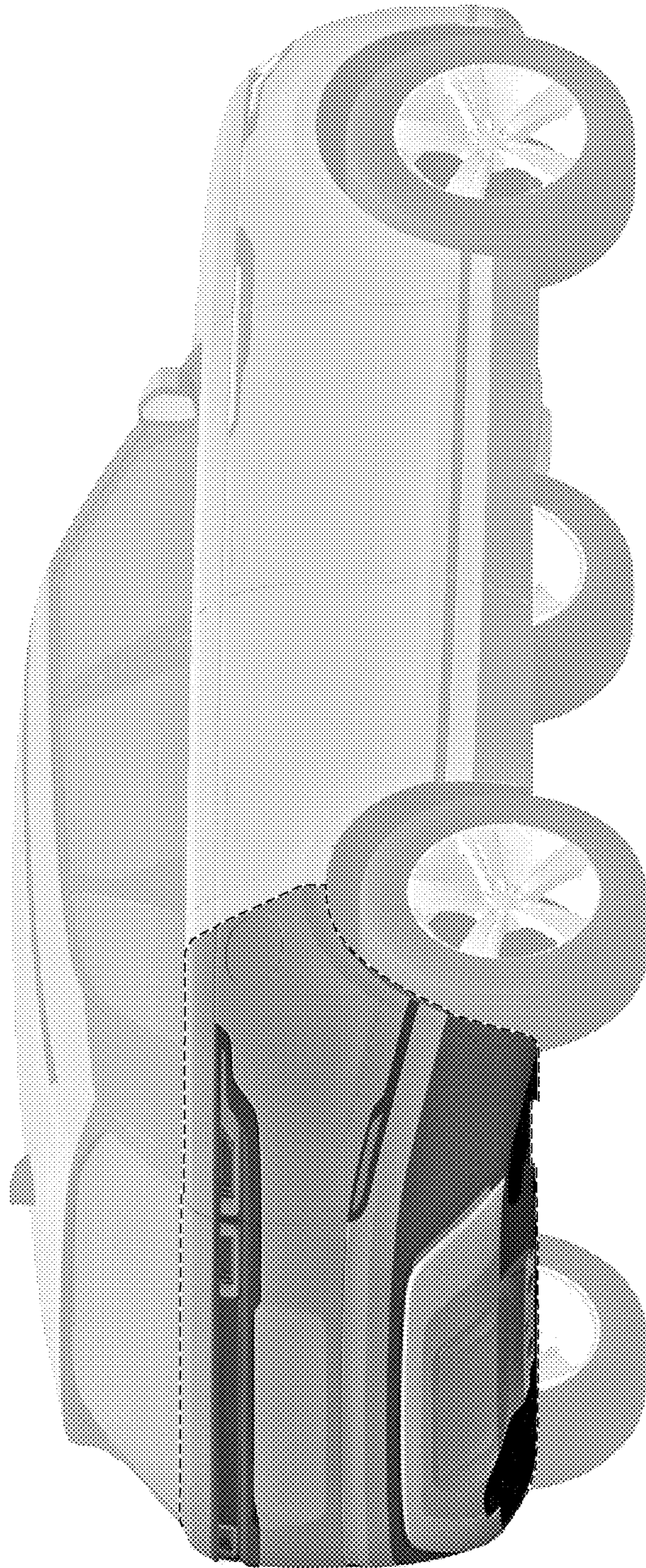

FIG. 1



FIG. 2

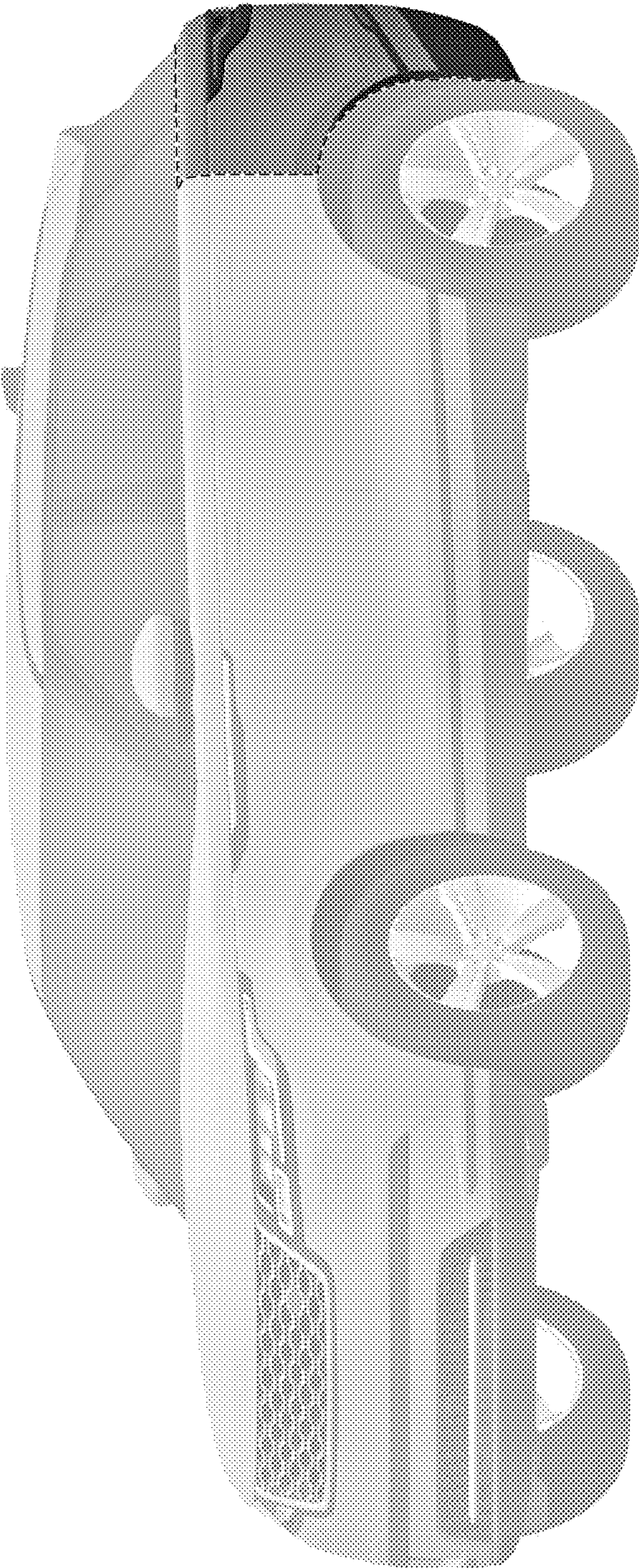

FIG. 3

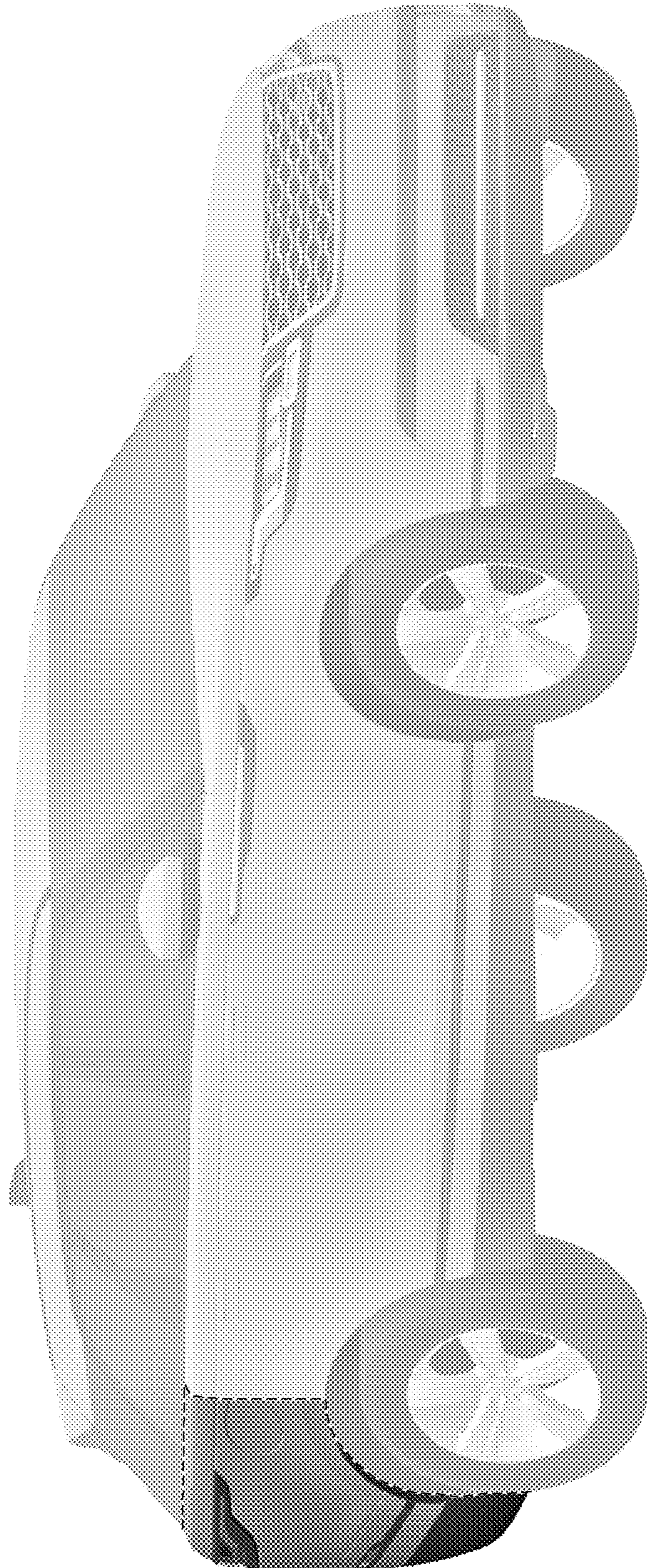

FIG. 4

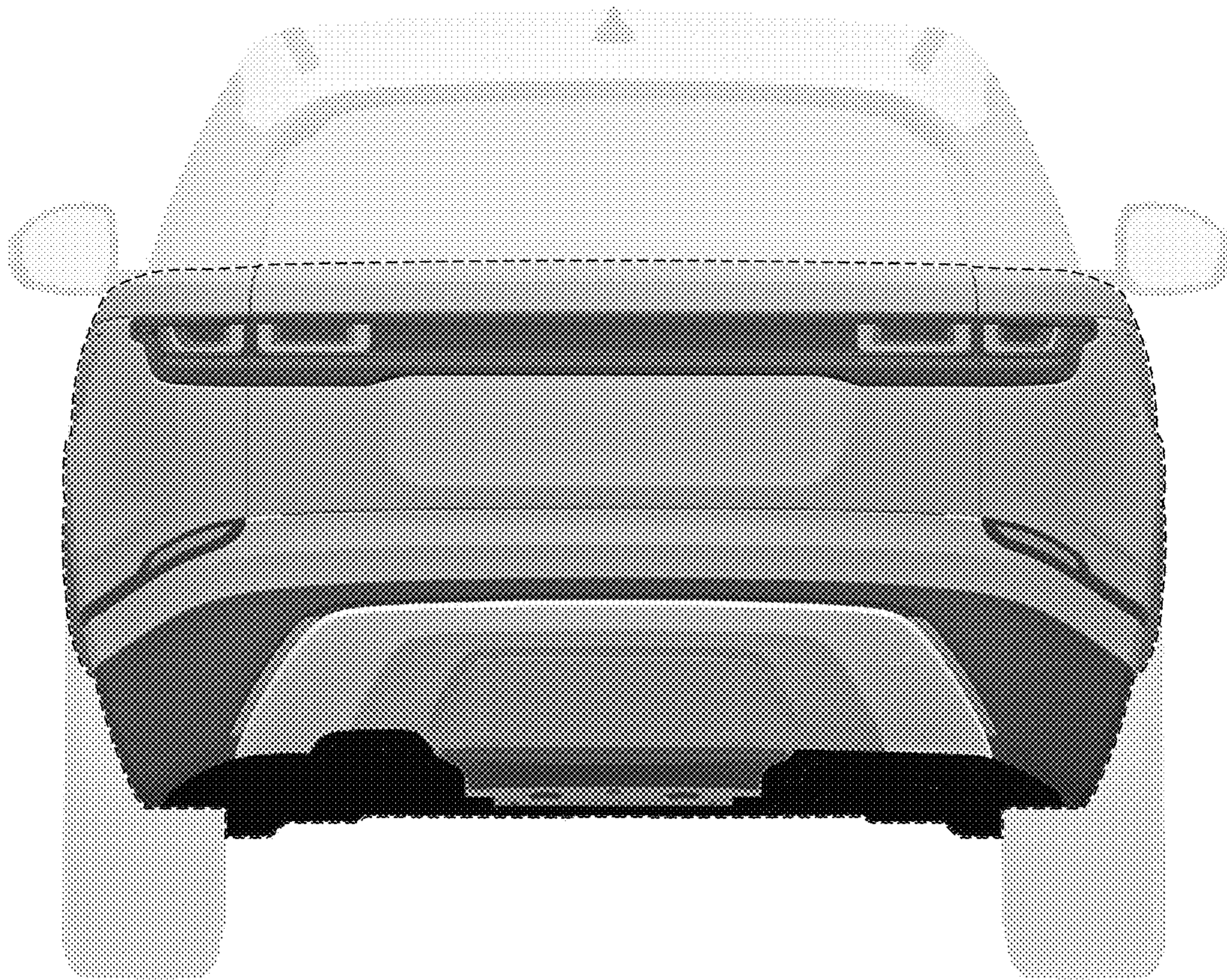

FIG. 5

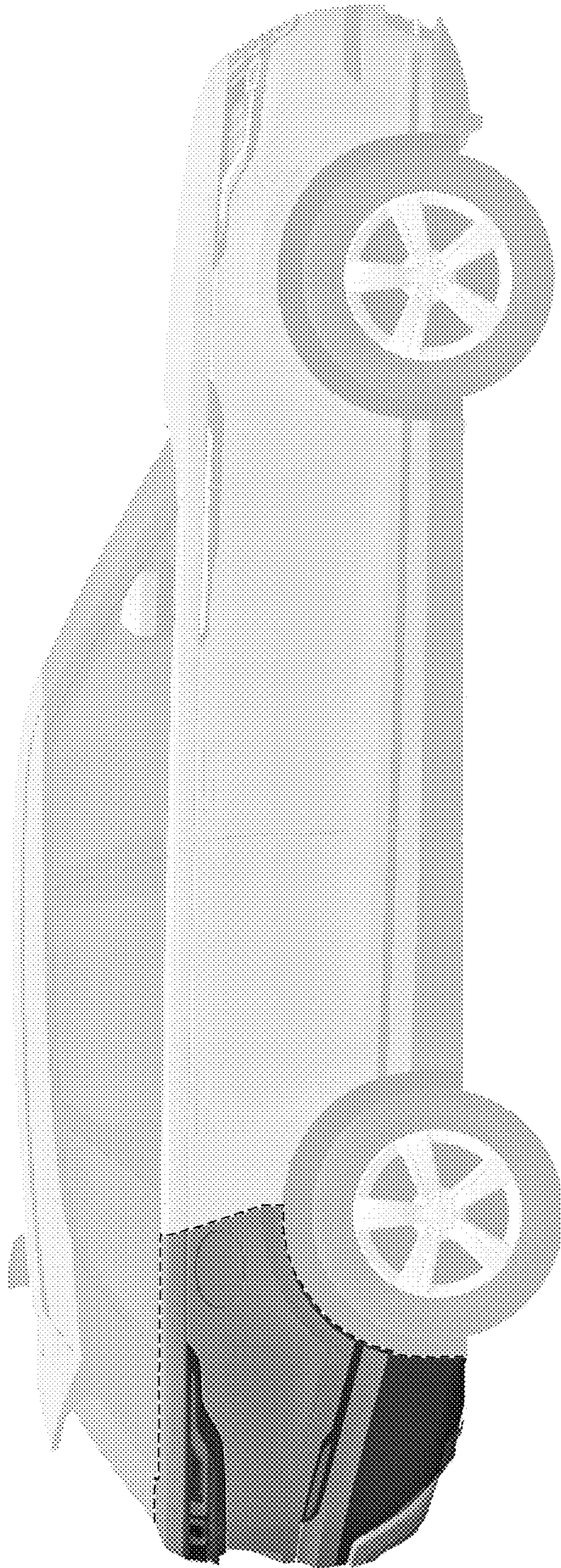

FIG. 6

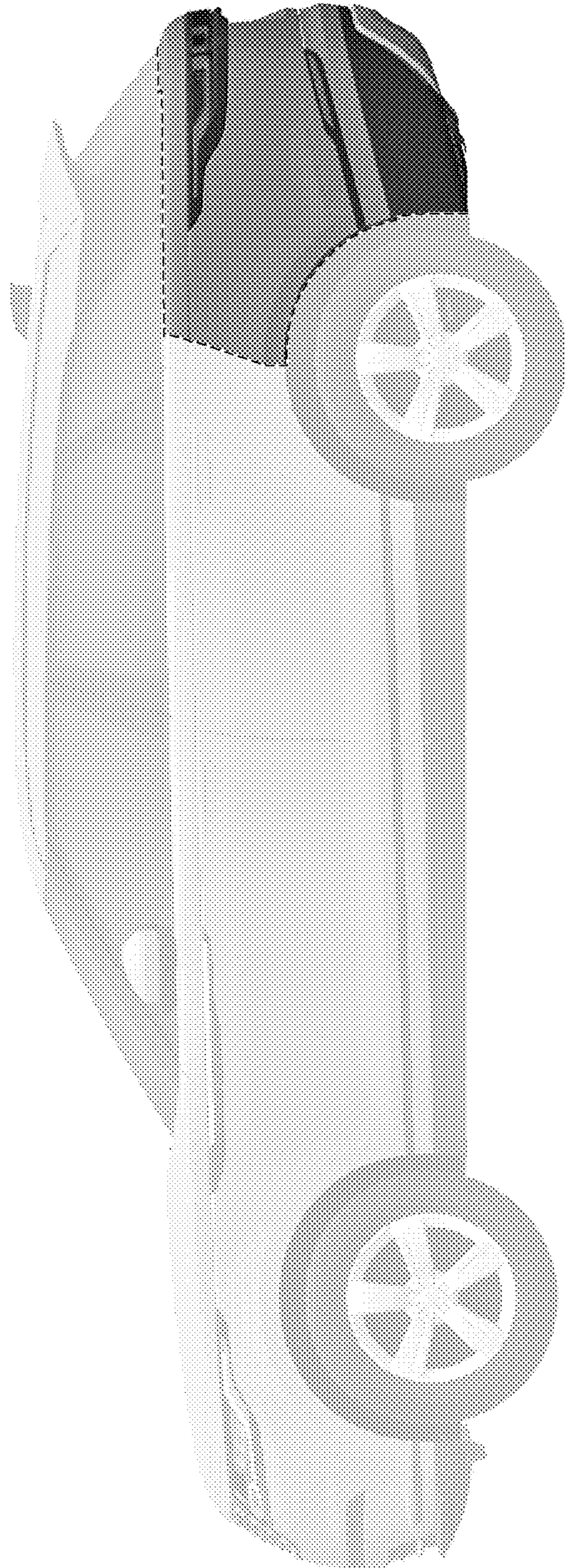

FIG. 7



FIG. 8