



US00D863070S

(12) **United States Design Patent** (10) **Patent No.:** **US D863,070 S**
Bove (45) **Date of Patent:** **** Oct. 15, 2019**

(54) **WATCH CASE**
(71) Applicant: **BREITLING SA**, Grenchen (CH)
(72) Inventor: **Guy Bove**, Genève (CH)
(**) Term: **15 Years**
(21) Appl. No.: **35/505,692**
(22) Filed: **Mar. 21, 2018**
(80) **Hague Agreement Data**
Int. Filing Date: **Mar. 21, 2018**
Int. Reg. No.: **DM/100479**
Int. Reg. Date: **Mar. 21, 2018**
Int. Reg. Pub. Date: **Sep. 21, 2018**
(51) **LOC (12) Cl.** **10-07**
(52) **U.S. Cl.**
USPC **D10/38**
CPC **A41D 19/0027** (2013.01)
(58) **Field of Classification Search**
USPC D10/1, 2, 10, 30-39, 98, 99, 122-128,
D10/132
CPC A41D 19/0027; A45C 11/10; G04C 19/00;
G04C 19/02; G04B 19/00; G04B 19/025;
G04B 19/08; G04B 19/048; G04B 19/04;
G04B 19/046; G04B 19/06; G04B
19/065; G04B 19/082; G04B 19/085;
G04B 19/087; G04B 19/10; G04B
19/103; G04B 19/106; G04B 47/042;
G04B 19/12; G04B 19/18; G04B 19/223;
G04B 19/23; G04B 19/24; G04B 19/241;
G04B 19/243; G04D 3/04
See application file for complete search history.

(56) **References Cited**
U.S. PATENT DOCUMENTS
D445,343 S * 7/2001 Schneider D10/30
D562,704 S * 2/2008 Lalo D10/32
D563,802 S * 3/2008 Loth D10/39

D565,431 S * 4/2008 Hatt D10/38
D565,987 S * 4/2008 Krieger D10/126
D566,581 S * 4/2008 Giannini D10/32
D568,178 S * 5/2008 Giannini D10/32
D571,230 S * 6/2008 Krieger D10/39
D574,733 S * 8/2008 Blair D10/32
D582,792 S * 12/2008 Lalo D10/38
D586,668 S * 2/2009 Dias D10/38
D589,378 S * 3/2009 Takahashi D10/32
D605,533 S * 12/2009 Schoepfer D10/38
D609,583 S * 2/2010 Lalo D10/32
D609,584 S * 2/2010 Lalo D10/32
D609,587 S * 2/2010 Lalo D10/38
D666,924 S * 9/2012 Ahlstrom D10/32
D666,925 S * 9/2012 Ahlstrom D10/32
D672,664 S * 12/2012 Monachon D10/32
D682,713 S * 5/2013 Vaptzarof D10/39
D720,240 S * 12/2014 Takahashi D10/39
D731,327 S * 6/2015 Schoepfer D10/39
D732,981 S * 6/2015 Waecker D10/38
D740,695 S * 10/2015 Waecker D10/38
D784,829 S * 4/2017 Kita D10/38
D793,871 S * 8/2017 Lasserre D10/30
D817,194 S * 5/2018 Monachon D10/39
D828,185 S * 9/2018 Savolainen D10/38
D836,008 S * 12/2018 Schoepfer D10/39
D848,865 S * 5/2019 Behling D10/32
D850,292 S * 6/2019 Dicks D10/30

(Continued)

Primary Examiner — Richard E Chilcot

(57) **CLAIM**

The ornamental design for watch case, as shown and described.

DESCRIPTION

1. Watch case
FIG. 1.1 is a top view of a watch case according to the present invention;
FIG. 1.2 is a bottom view;
FIG. 1.3 is a right side view;
FIG. 1.4 is a left side view;
FIG. 1.5 is a front view;
FIG. 1.6 is a rear view; and,
FIG. 1.7 is a perspective view.

1 Claim, 7 Drawing Sheets

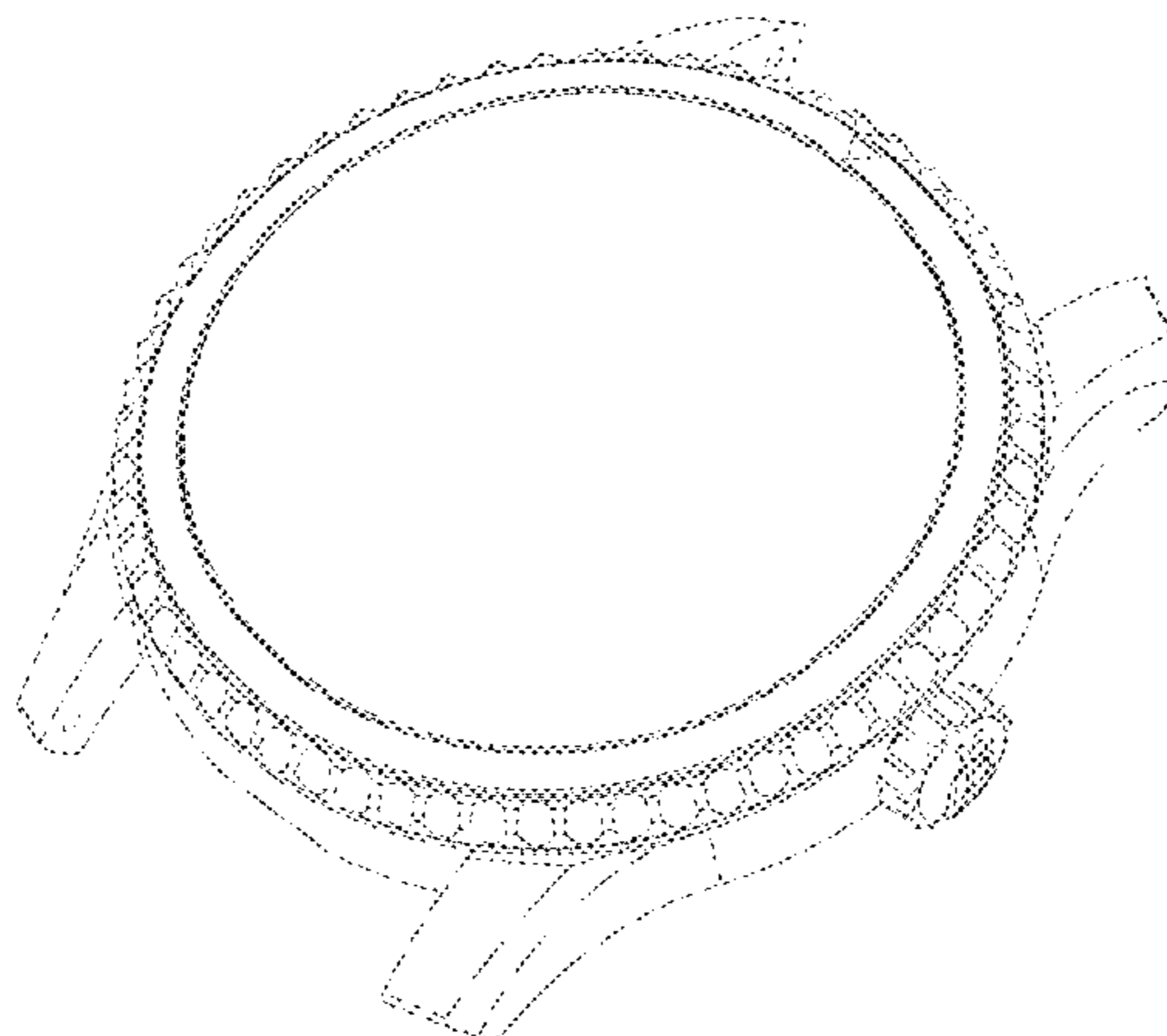

(56)

References Cited

U.S. PATENT DOCUMENTS

D850,295 S * 6/2019 Behling D10/39
D850,936 S * 6/2019 Behling D10/32

* cited by examiner

1.1

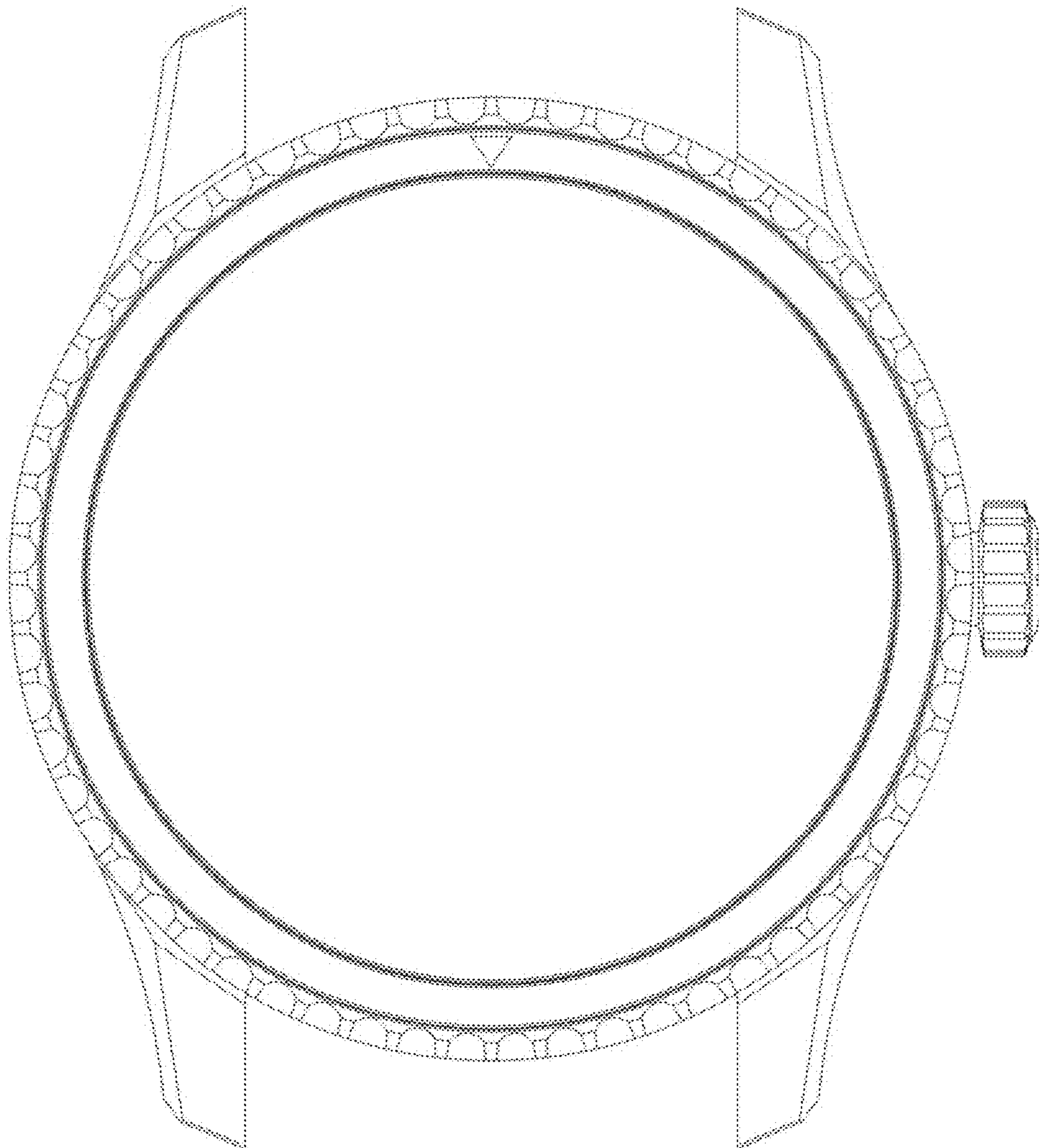

1.2

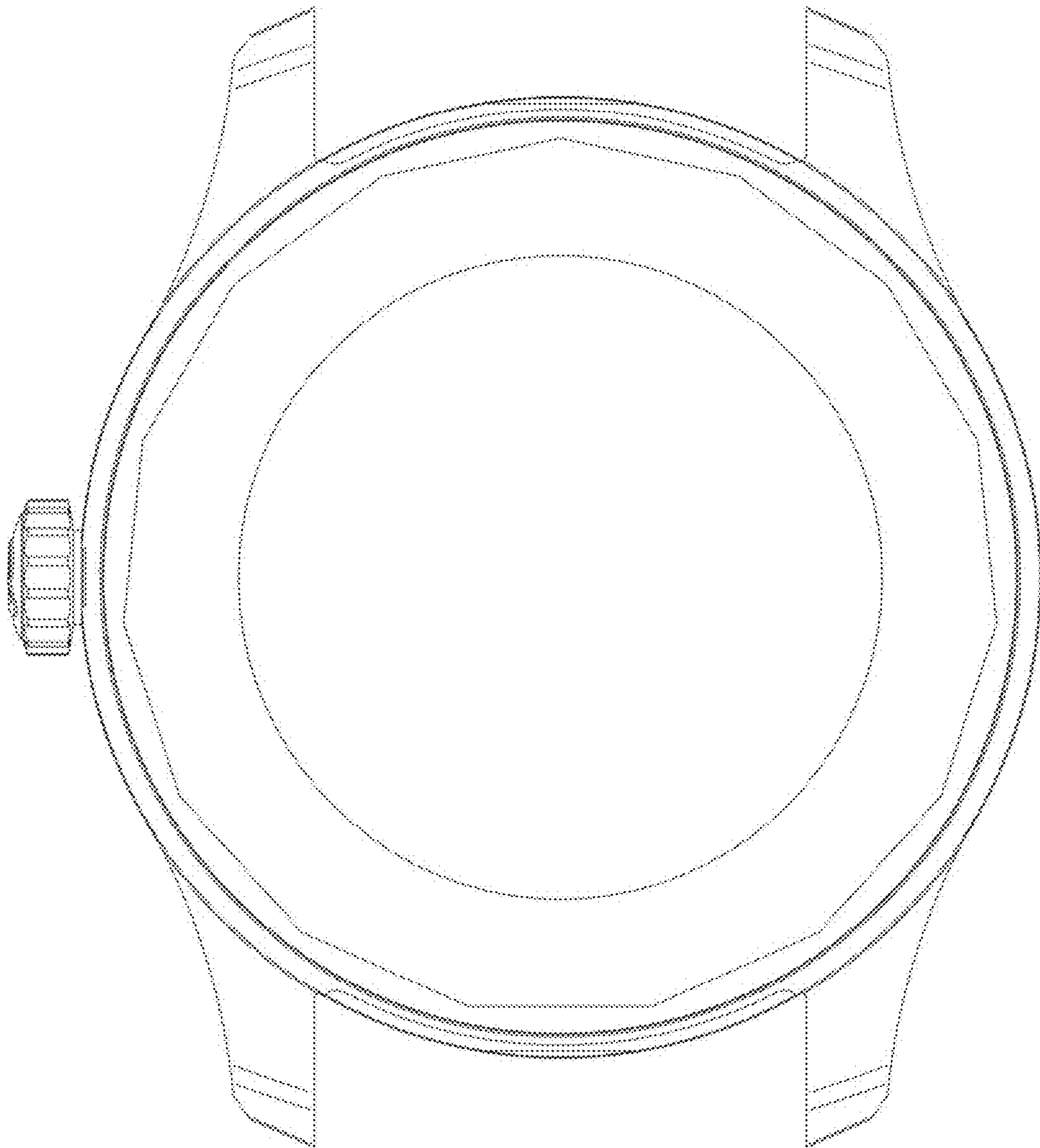

1.3

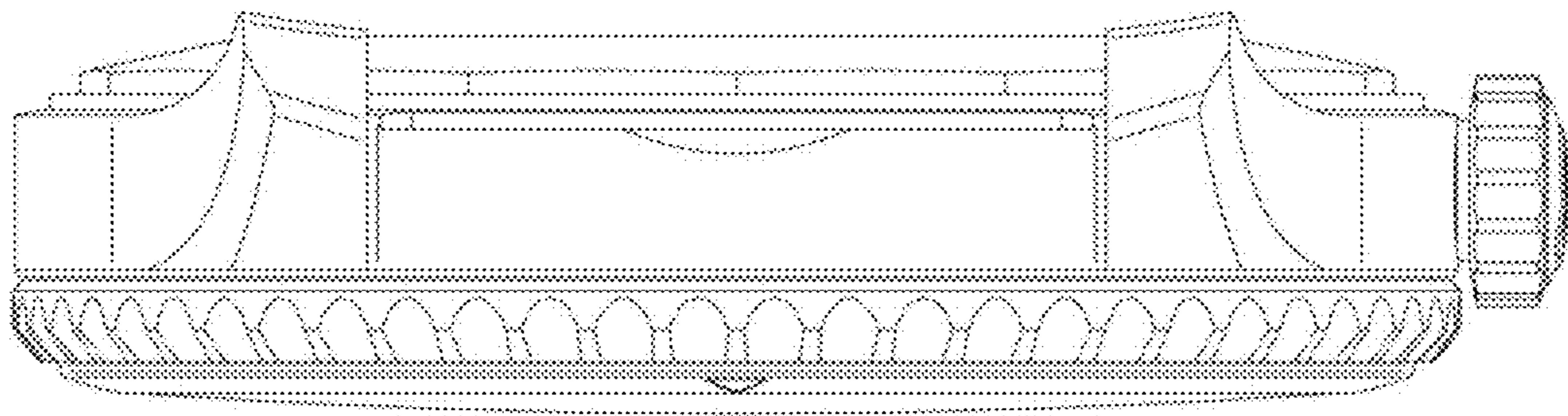

1.4

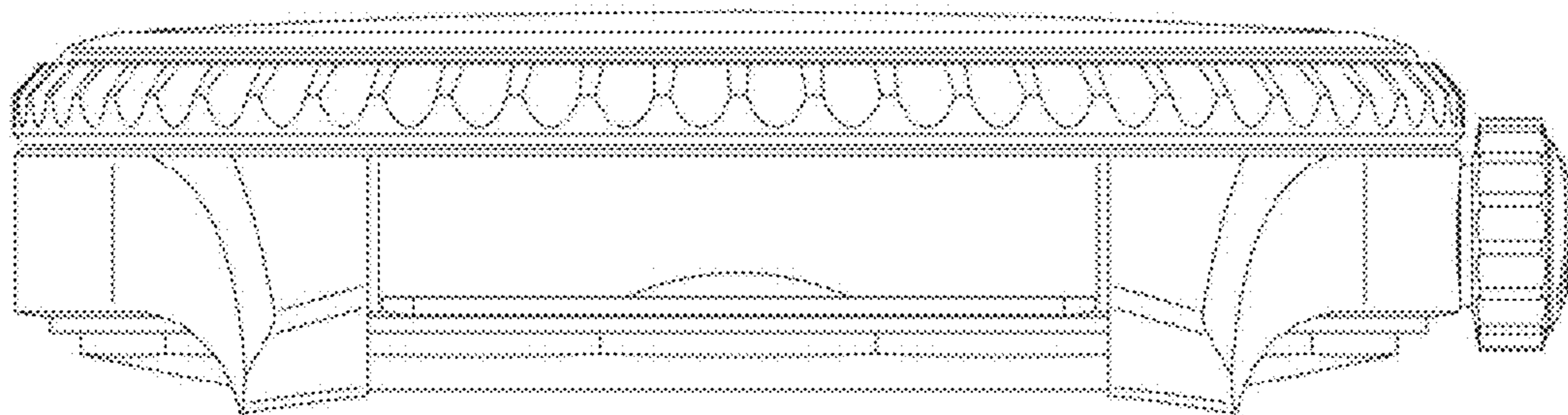

1.5

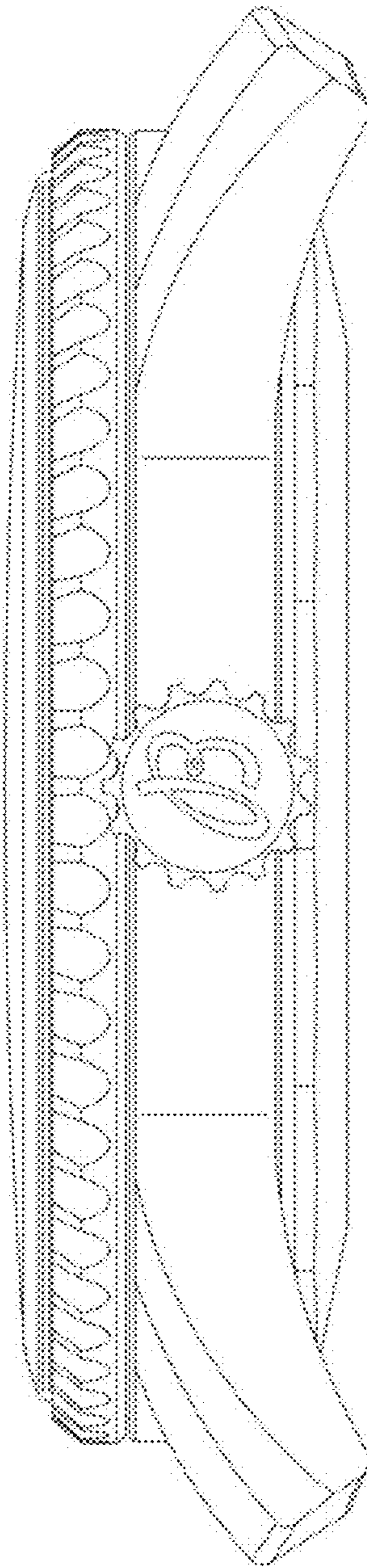

1.6

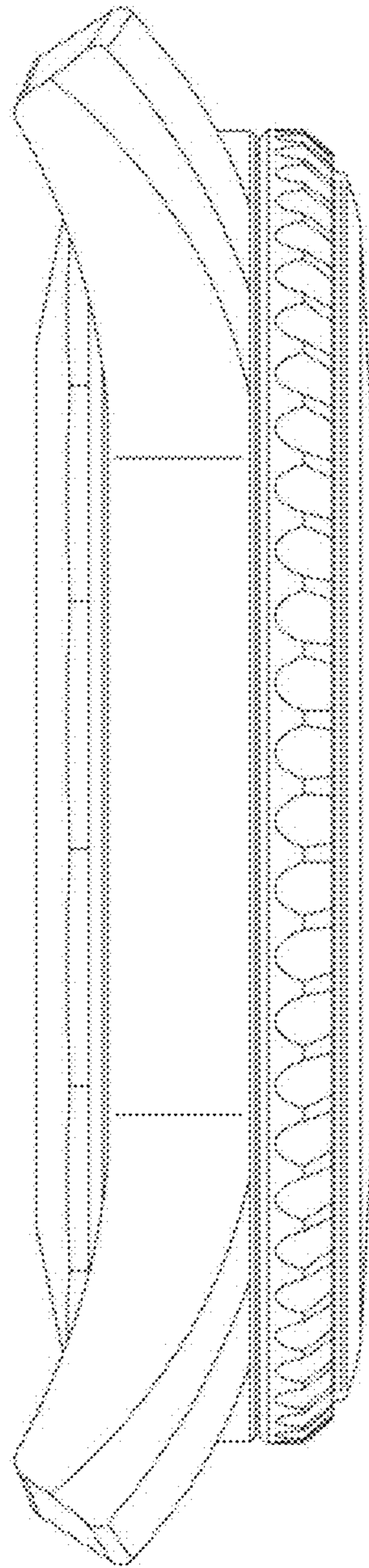

1.7

