

US00D863026S

(12) **United States Design Patent** (10) **Patent No.:** **US D863,026 S**
Gokcebay (45) **Date of Patent:** **** Oct. 15, 2019**

- (54) **ELECTRONIC LOCKER LOCK**
- (71) Applicant: **Digilock Asia Ltd.**, Kowloon (HK)
- (72) Inventor: **Asil T. Gokcebay**, Petaluma, CA (US)
- (73) Assignee: **Digiluck Asia Ltd.**, Kowloon (HK)
- (**) Term: **15 Years**
- (21) Appl. No.: **29/632,688**
- (22) Filed: **Jan. 9, 2018**

5,894,277 A	4/1999	Keskin et al.	
D426,833 S	6/2000	Vanelli	
D495,578 S	9/2004	Sampson et al.	
D512,898 S	12/2005	Metivier et al.	
D580,739 S *	11/2008	Pelletier	D8/330
7,482,907 B2	1/2009	Denison et al.	
D593,398 S *	6/2009	Pelletier	D8/330
D629,789 S	12/2010	Andre et al.	
D630,489 S	1/2011	Gratzki et al.	
D656,496 S	3/2012	Andre et al.	

(Continued)

Primary Examiner — Ian Simmons
Assistant Examiner — Yolanda Robinson
 (74) *Attorney, Agent, or Firm* — Thomas M. Freiburger

Related U.S. Application Data

- (62) Division of application No. 29/559,160, filed on Mar. 24, 2016, now Pat. No. Des. 809,896.
- (51) **LOC (12) Cl.** **08-07**
- (52) **U.S. Cl.**
USPC **D8/330**
- (58) **Field of Classification Search**
USPC D8/301, 302, 330, 331, 400, 499;
D6/664; 70/57, 57.1, 14, 20, 91, 92, 102,
70/141, 237, 262, 263, 266, 278.1, 279.1,
70/416, 465, 442, 443, 214, 78, 447;
340/5.6, 5.61, 5.64, 5.73, 286.01, 542,
340/547, 545.1, 545.7; 292/336.3, 257,
292/194, 195, 198, 164, 165
CPC E05B 49/00; E05B 41/00; E05B 65/00;
E05B 65/52; E05B 51/00; G05B 19/00;
G05B 23/00
See application file for complete search history.

(57) **CLAIM**

The ornamental design for an electronic locker lock, substantially as shown and described.

DESCRIPTION

FIG. 1 is a front left perspective view of a first embodiment of an electronic locker lock according to my new design; FIG. 2 is a top plan view thereof; FIG. 3 is a rear elevation view thereof; FIG. 4 is a left side view thereof; FIG. 5 is a front elevation view thereof; FIG. 6 is a right side view thereof; FIG. 7 is a bottom plan view thereof; FIG. 8 is a front left perspective view of a second embodiment of an electronic locker lock according to my new design; FIG. 9 is a top plan view thereof; FIG. 10 is a rear elevation view thereof; FIG. 11 is a left side view thereof; FIG. 12 is a front elevation view thereof; FIG. 13 is a right side view thereof; and, FIG. 14 is a bottom plan view thereof. Features shown in dashed lines are not part of the claimed design.

(56) **References Cited**
 U.S. PATENT DOCUMENTS

5,033,282 A	7/1991	Gartner et al.
D331,888 S	12/1992	Lade
5,284,659 A	2/1994	Cherukuri et al.
5,568,006 A	10/1996	Luff et al.
5,884,644 A	3/1999	Dunn

1 Claim, 6 Drawing Sheets

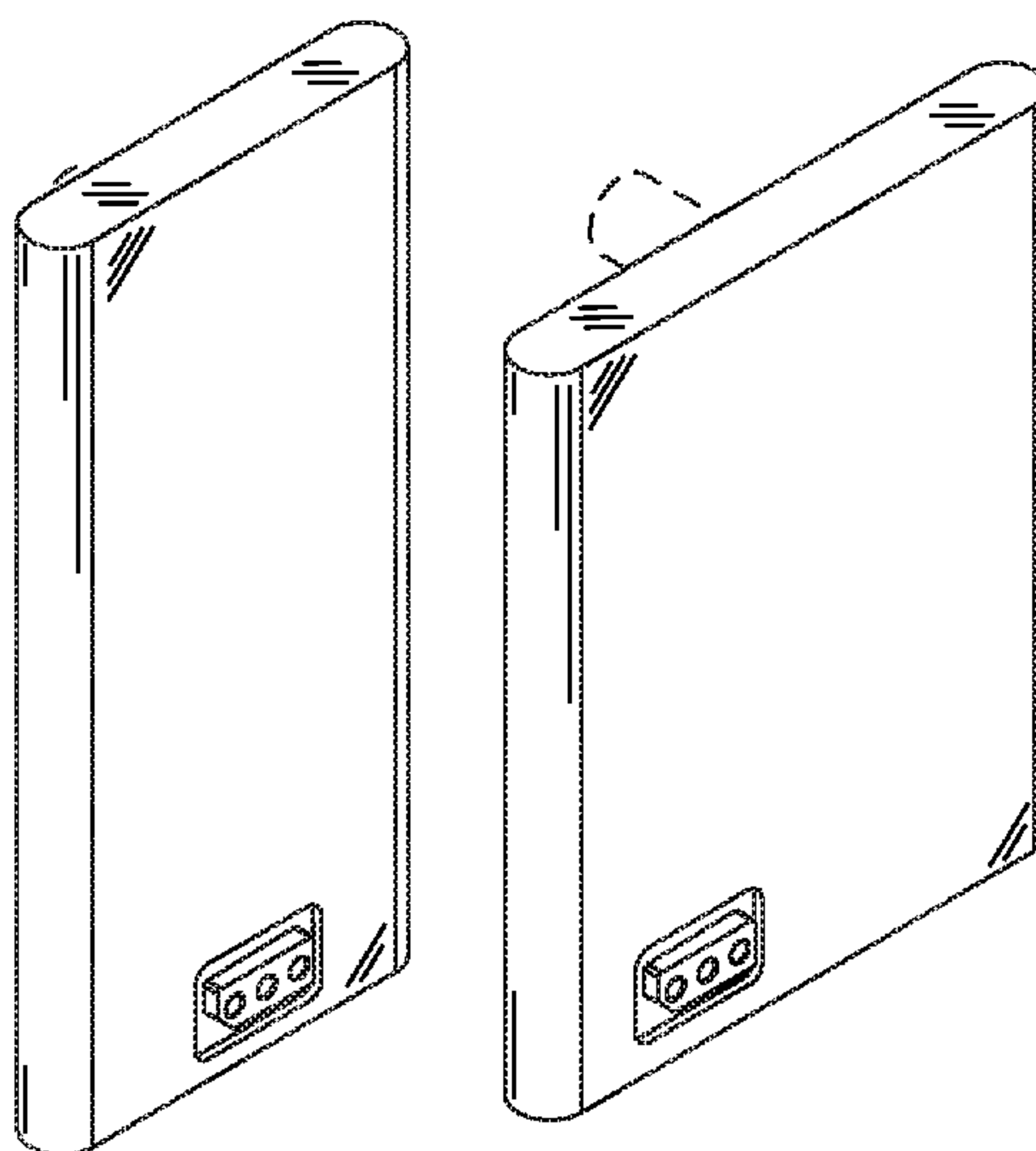

(56)

References Cited

U.S. PATENT DOCUMENTS

8,161,781	B2	4/2012	Gokcebay	
D686,055	S	7/2013	Li	
D686,056	S	7/2013	Li	
8,495,898	B2	7/2013	Gokcebay	
8,616,031	B2	12/2013	Ulrich et al.	
D730,712	S	6/2015	Gokcebay et al.	
D730,714	S	6/2015	Gokcebay et al.	
D730,715	S	6/2015	Gokcebay et al.	
D731,286	S	6/2015	Gokcebay et al.	
D731,287	S	6/2015	Gokcebay et al.	
D733,519	S	7/2015	Gokcebay et al.	
D734,125	S	7/2015	Kodama	
D734,650	S	7/2015	Kodama	
D737,114	S	8/2015	Gokcebay et al.	
D752,945	S	4/2016	Gokcebay et al.	
D752,947	S	4/2016	Gokcebay et al.	
D752,948	S	4/2016	Gokcebay et al.	
D752,949	S	4/2016	Gokcebay et al.	
D753,463	S	4/2016	Gokcebay et al.	
D762,100	S	7/2016	Gokcebay et al.	
D762,101	S	7/2016	Gokcebay et al.	
D762,102	S	7/2016	Gokcebay et al.	
D762,103	S	7/2016	Gokcebay et al.	
D764,255	S	8/2016	Gokcebay et al.	
D764,891	S	8/2016	Gokcebay et al.	
D764,892	S	8/2016	Gokcebay et al.	
D764,893	S	8/2016	Gokcebay et al.	
9,422,746	B1	8/2016	Zhang et al.	
D789,768	S *	6/2017	Hsu	D8/330
9,672,673	B1	6/2017	Gokcebay	
D802,395	S *	11/2017	Hsu	D8/330
2013/0192317	A1 *	8/2013	McKibben	E05B 47/0001 70/278.1

* cited by examiner

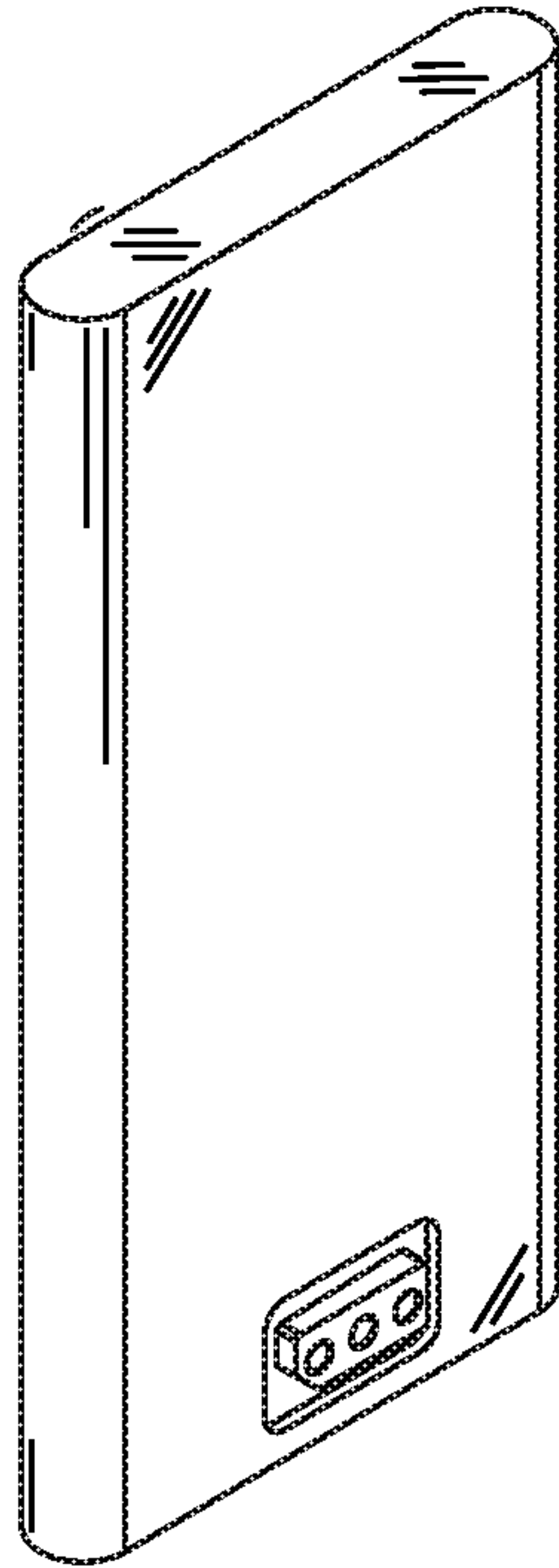

FIG. 1

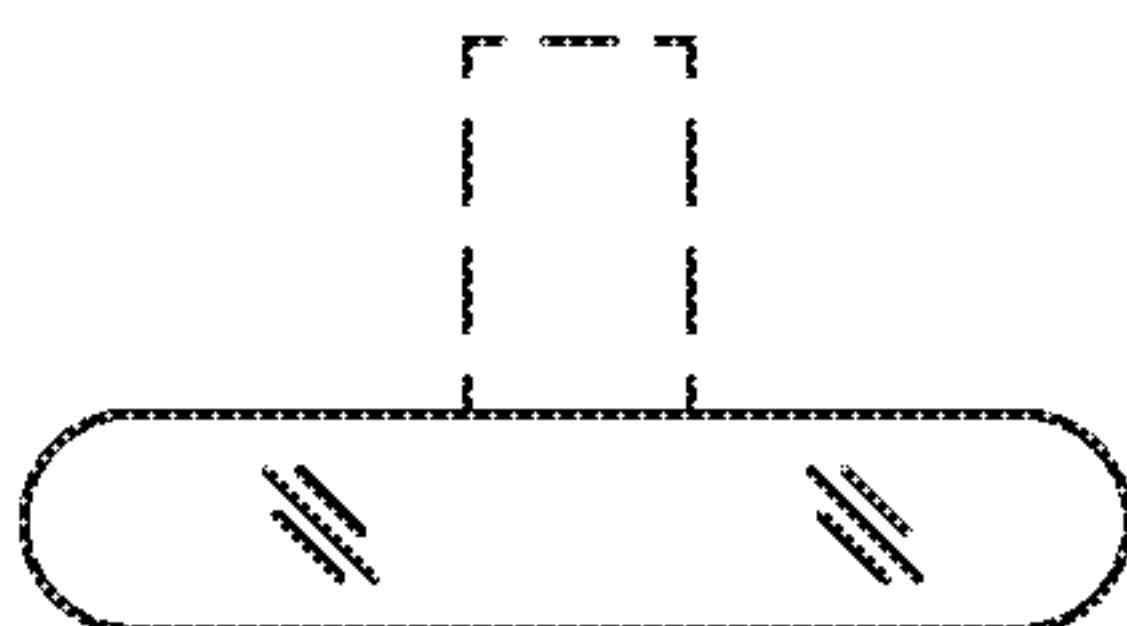

FIG. 2

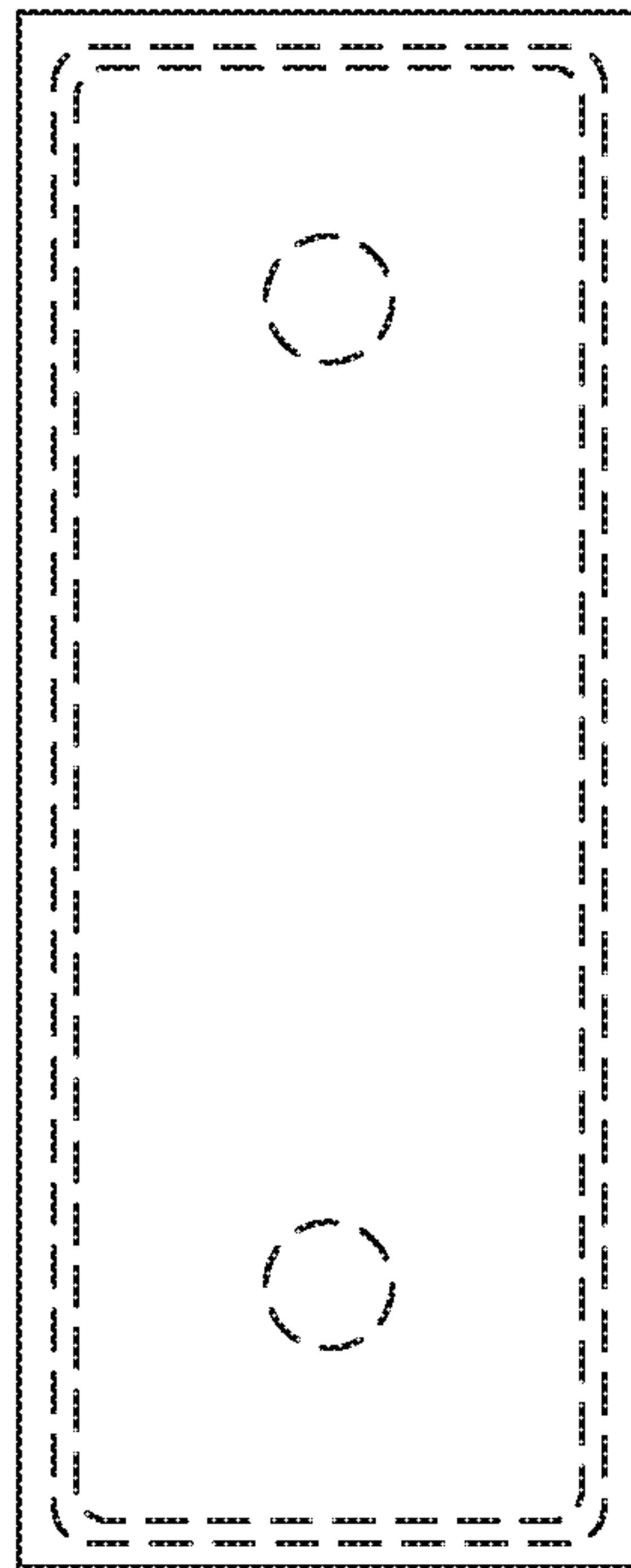

FIG. 3

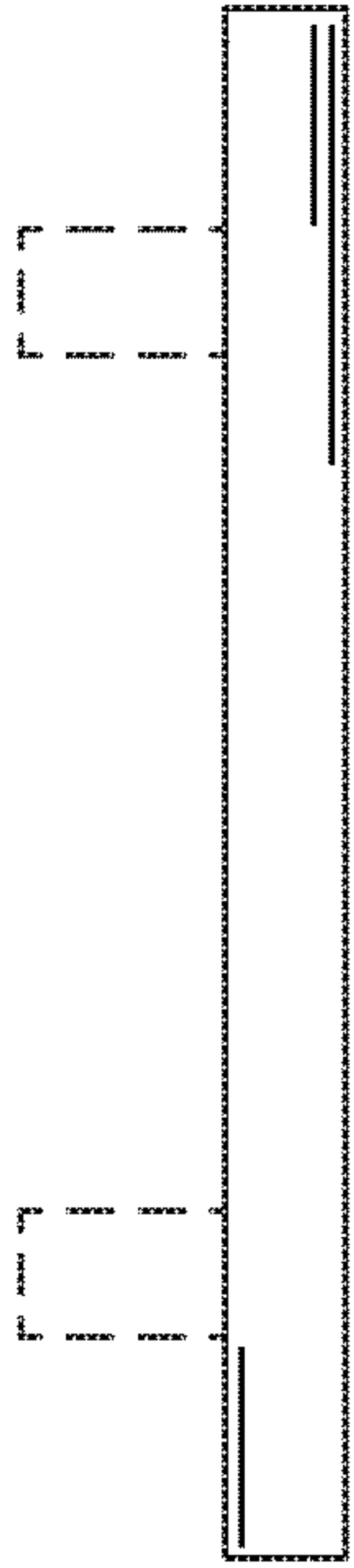

FIG. 4

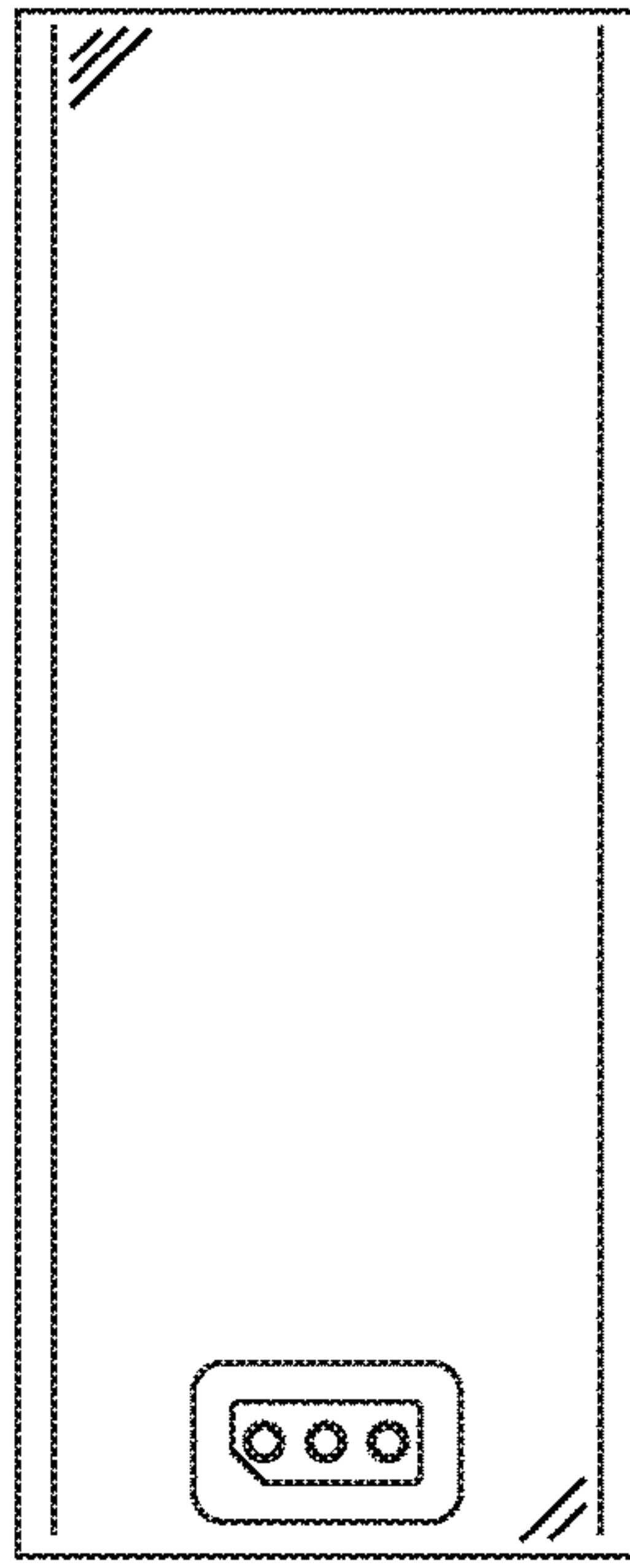

FIG. 5

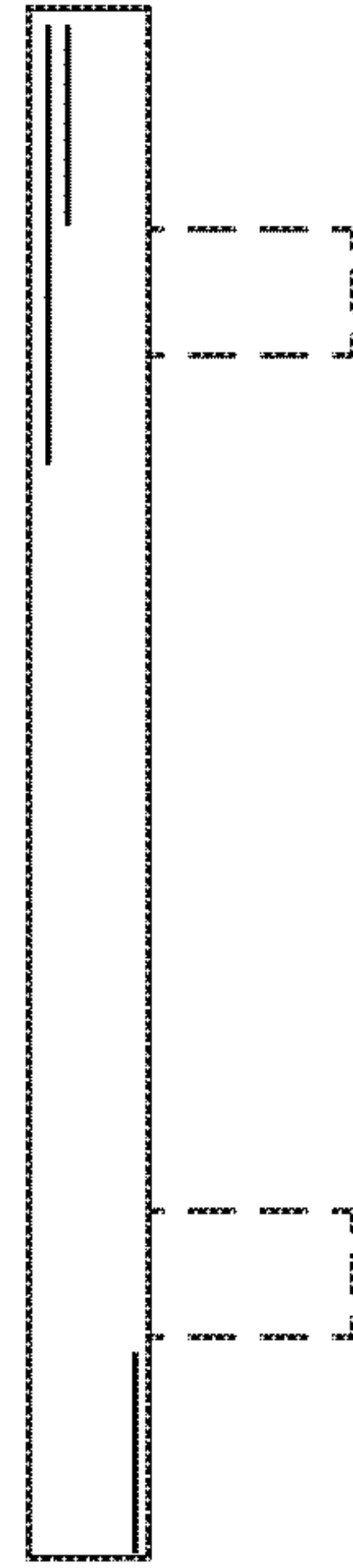

FIG. 6

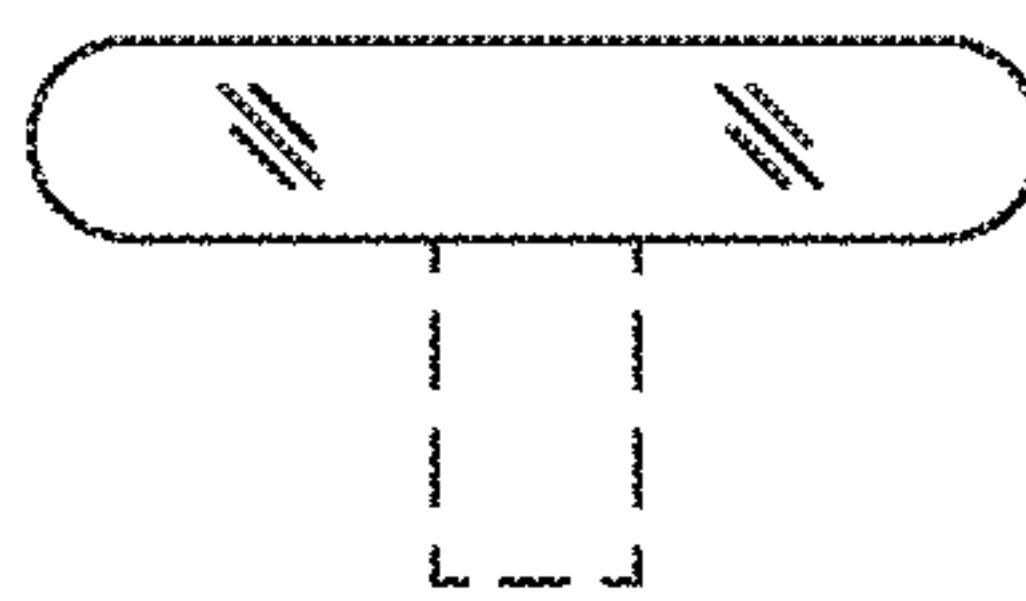

FIG. 7

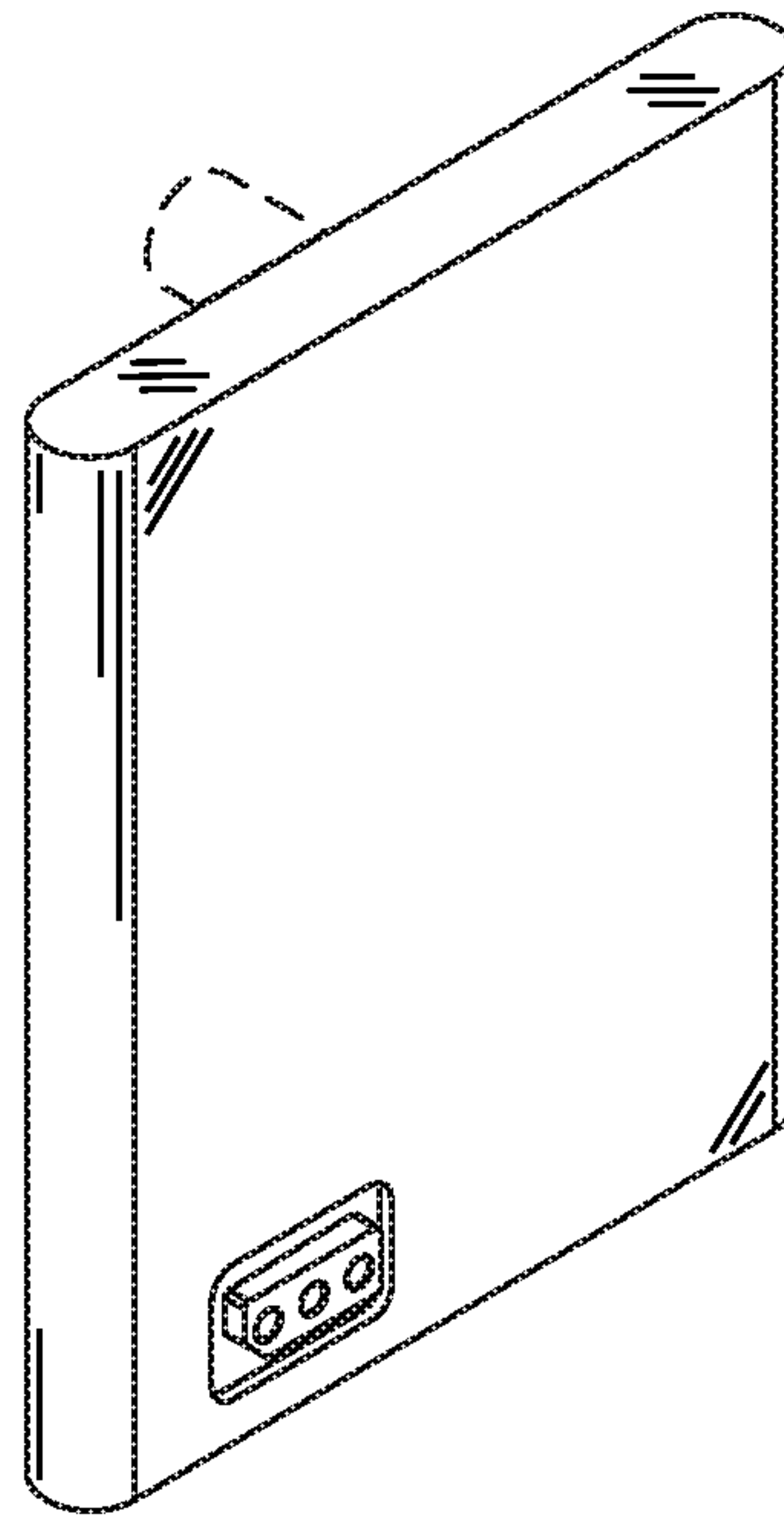

FIG. 8

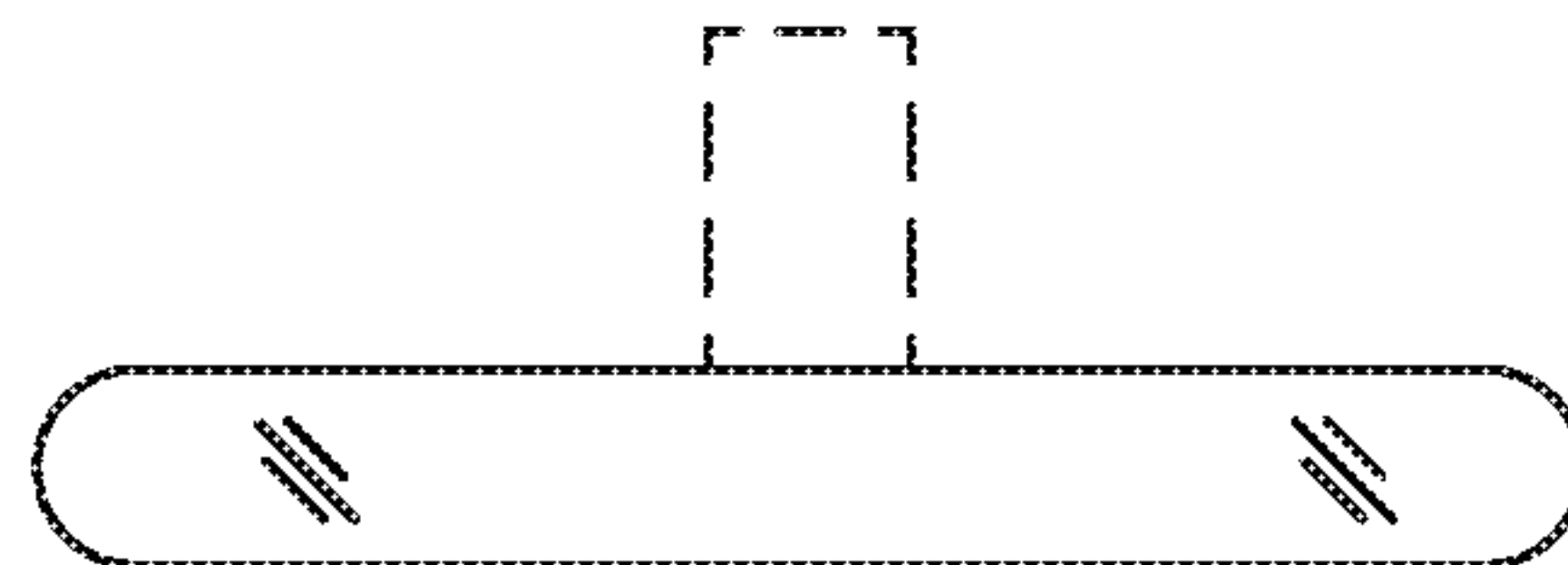

FIG. 9

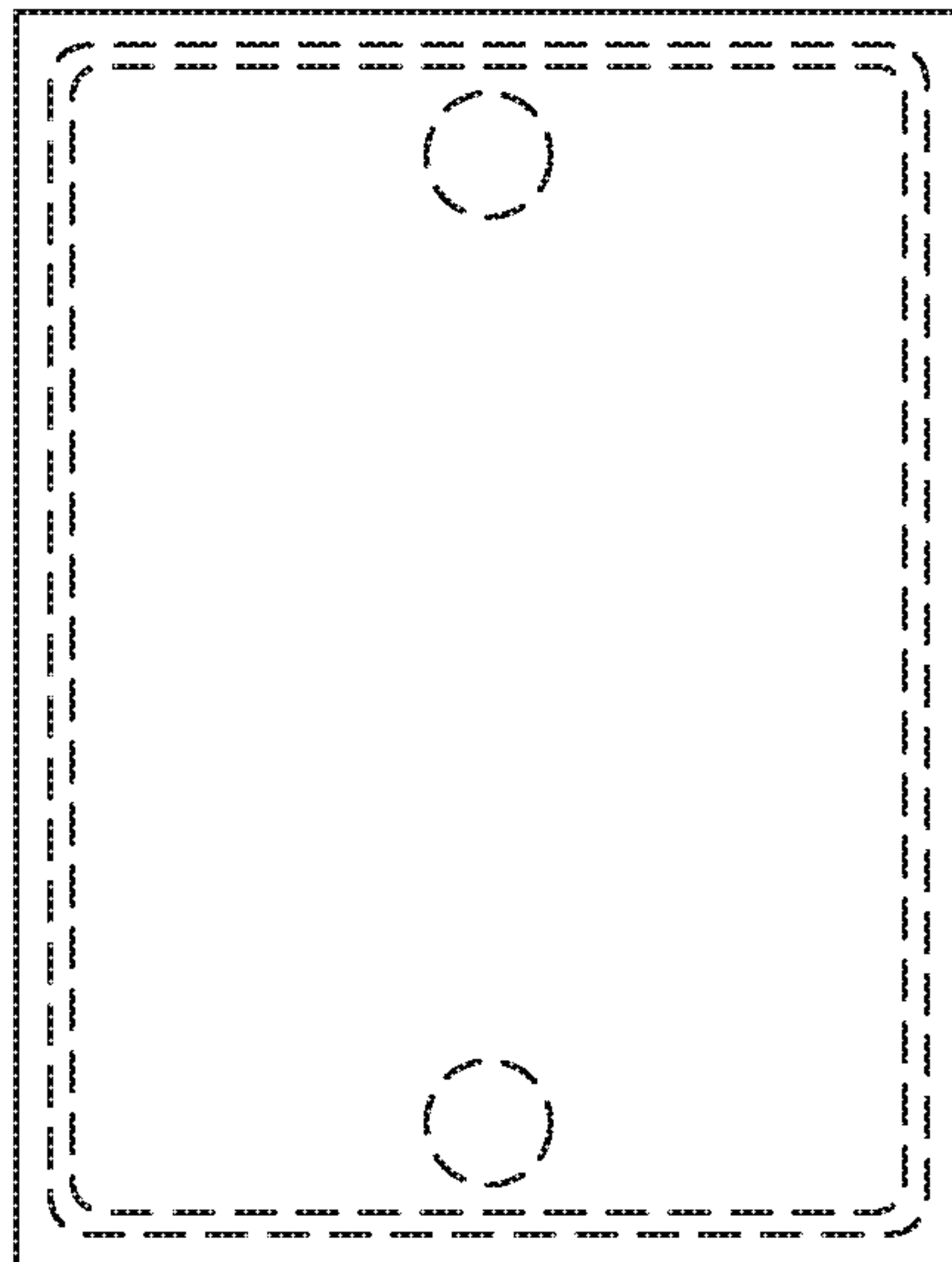

FIG. 10

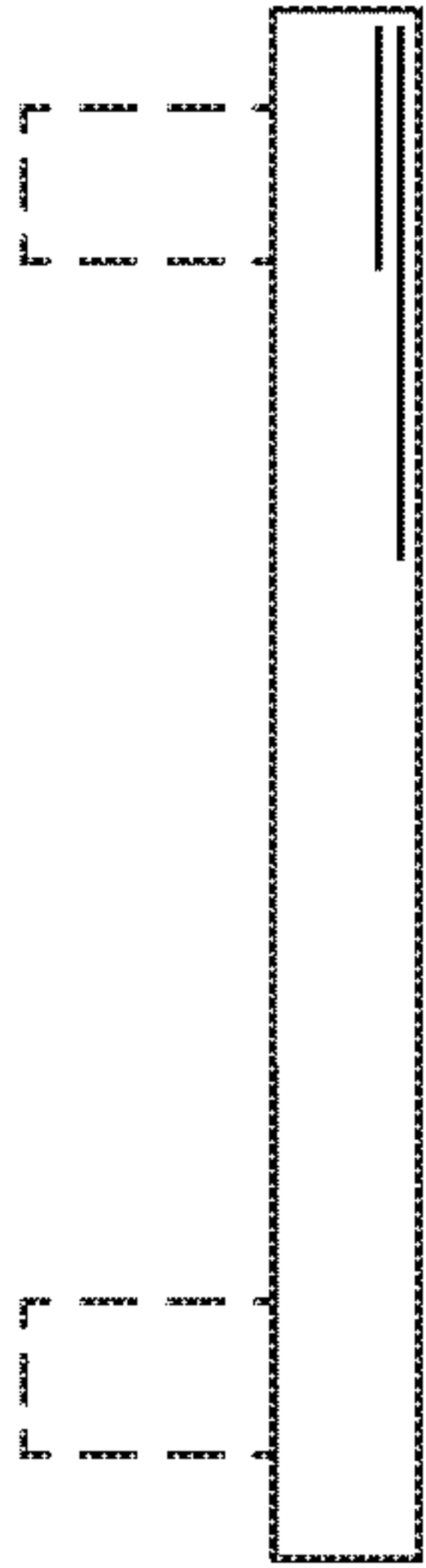

FIG. 11

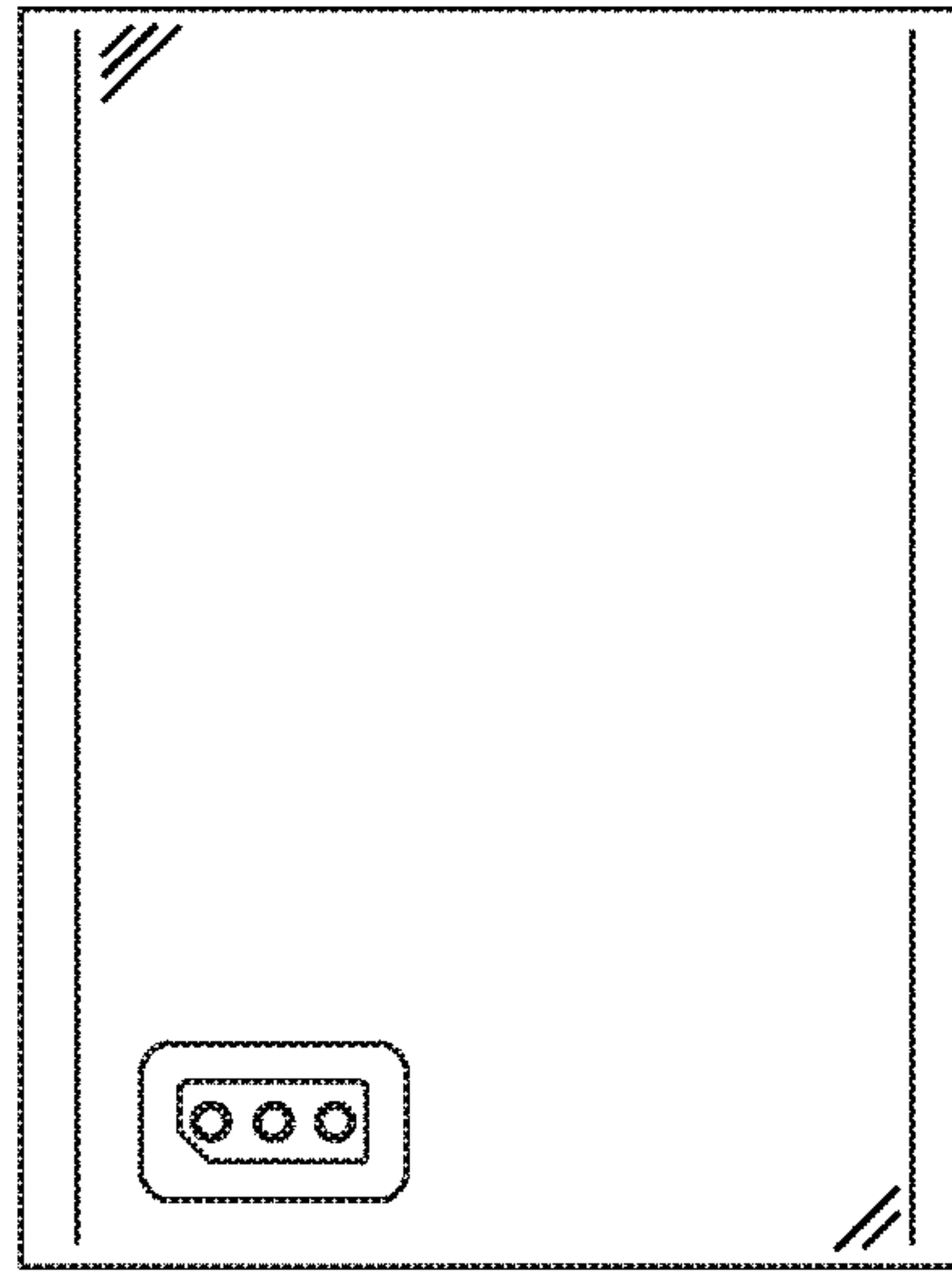

FIG. 12

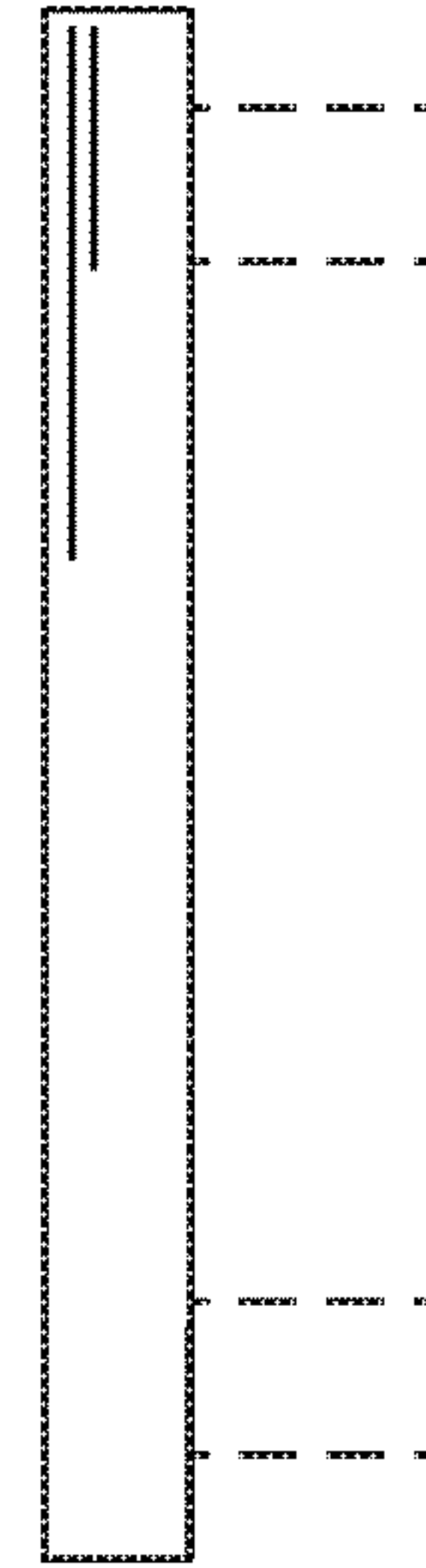

FIG. 13

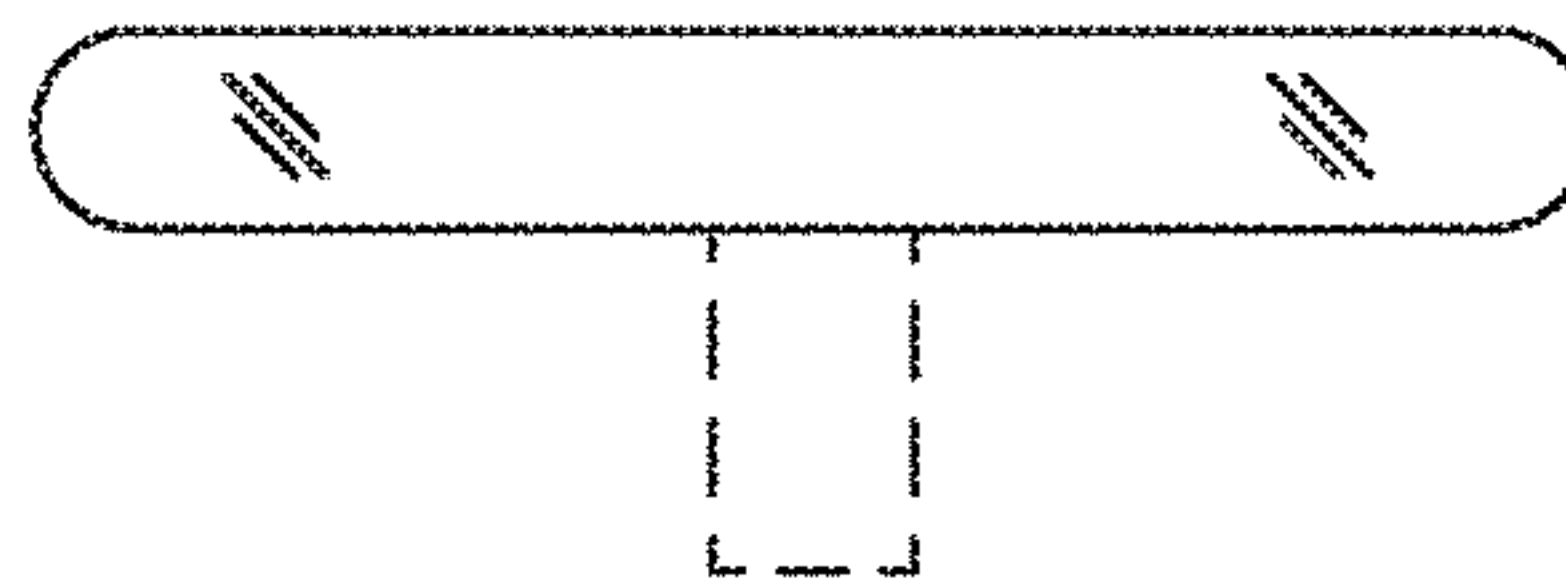

FIG. 14