



US00D862935S

(12) **United States Design Patent** (10) **Patent No.:** **US D862,935 S**
Pfister et al. (45) **Date of Patent:** **** Oct. 15, 2019**

(54) **MATTRESS COVER**

D353,072 S 12/1994 Cornell, Jr. et al.
6,199,231 B1 3/2001 Zafiroglu
6,216,292 B1 4/2001 Oakhill et al.
(Continued)

(71) Applicant: **Tempur World, LLC**, Lexington, KY (US)

(72) Inventors: **Brent Pfister**, Lexington, KY (US);
Oleg Bobrovskyj, Sunds (DK); **Halina Bobrovska**, Sunds (DK); **Andrij Rupa**, Sunds (DK)

FOREIGN PATENT DOCUMENTS

AU 201710516 3/2017
AU 201710521 3/2017
(Continued)

(73) Assignee: **TEMPUR WORLD, LLC**, Lexington, KY (US)

OTHER PUBLICATIONS

(**) Term: **15 Years**

TEMPUR-Pro Adapt, earliest review Aug. 2018, [online], [site visited Mar. 1, 2019]. Available from Internet, <URL: <https://www.tempurpedic.com/shop-mattresses/tempur-proadapt/v/2577/>> (Year: 2018).*

(21) Appl. No.: **29/634,313**

(22) Filed: **Jan. 19, 2018**

(Continued)

(51) **LOC (12) Cl.** **06-09**

(52) **U.S. Cl.**
USPC **D6/605**

(58) **Field of Classification Search**
USPC D6/333, 349, 355, 375, 388, 512, 563, D6/564, 595, 596, 601, 604, 605, 611, D6/707, 715, 716, 716.1; D24/183-185, D24/234; D21/803, 804, 805, 809; 5/401, 420, 600, 630, 631, 632, 633, 635, 5/636, 638, 639, 646, 652, 652.1, 655, 5/703, 730; 297/1, 2, 4, 93, 180.11, 297/195.1, 195.11, 195.13, 393, 397, 297/452.12, 452.14, 452.15, 452.21, 297/452.24, 452.26, 452.48, 452.62, 482
CPC A47G 9/10; A47G 9/1009; A47G 9/1027; A47G 9/1045; A47G 9/1063; A47G 9/1072; A47G 9/1081

See application file for complete search history.

Primary Examiner — Michelle E. Wilson
Assistant Examiner — Sanjeev Paul
(74) *Attorney, Agent, or Firm* — Middleton Reutlinger

(57) **CLAIM**

The ornamental design for a mattress cover, as shown and described.

DESCRIPTION

FIG. 1 is a front elevational view of the mattress cover design of the present invention;
FIG. 2 is a rear elevational view of the mattress cover design of FIG. 1;
FIG. 3 is a left side elevational view of the mattress cover of FIG. 1;
FIG. 4 is a right side elevational view of the mattress cover of FIG. 1;
FIG. 5 is a top view of the mattress cover of FIG. 1;
FIG. 6 is a bottom view of the mattress cover of FIG. 1; and,
FIG. 7 is a perspective view of the mattress cover of FIG. 1.

(56) **References Cited**

U.S. PATENT DOCUMENTS

D38,427 S 1/1907 Pronberger
D202,091 S 8/1965 Broderick

1 Claim, 5 Drawing Sheets

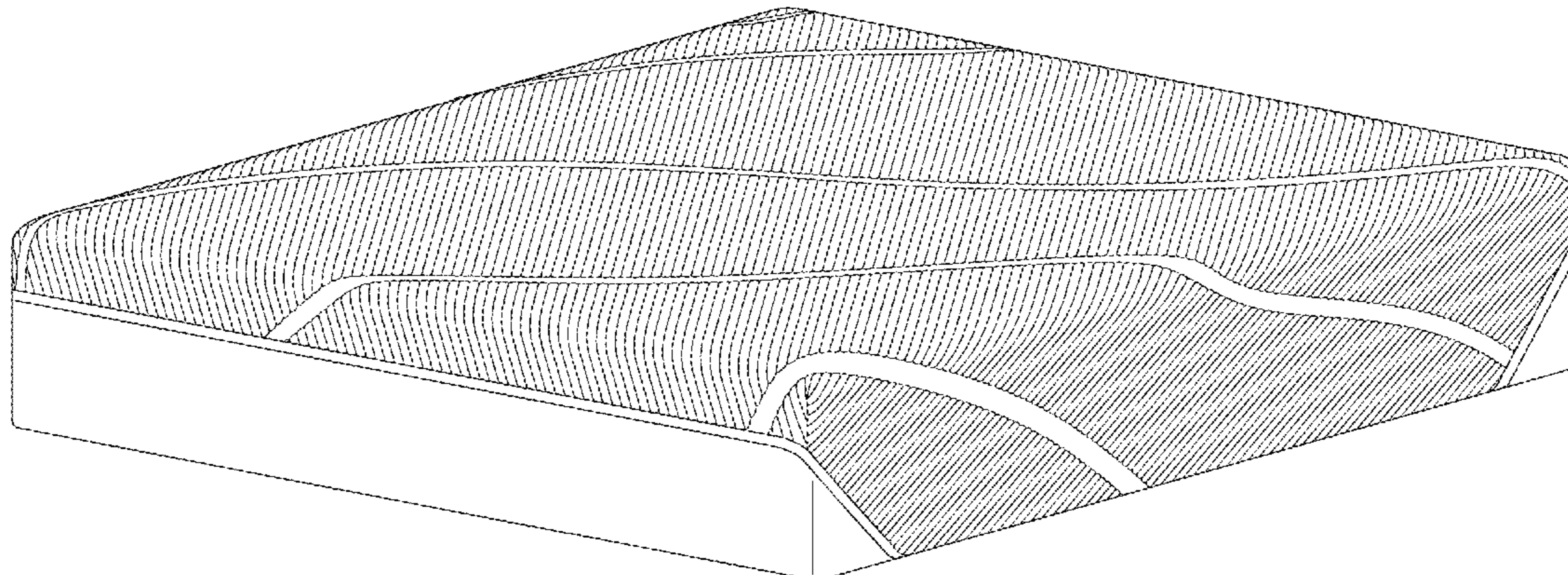

(56)

References Cited

U.S. PATENT DOCUMENTS

6,253,398 B1 7/2001 Yim
 D488,661 S 4/2004 Barman
 D517,848 S 3/2006 Contreras
 D518,672 S 4/2006 Contreras
 D519,311 S 4/2006 Contreras
 D587,055 S 2/2009 Tucker
 D600,485 S 9/2009 Tucker
 D606,353 S 12/2009 Tucker
 D616,236 S 5/2010 Morrison
 D621,198 S 8/2010 Morrison
 D622,088 S 8/2010 Morrison
 D622,531 S 8/2010 Morrison et al.
 D622,996 S 9/2010 Morrison et al.
 D634,148 S 3/2011 Morrison
 D640,082 S 6/2011 Morrison
 D642,847 S 8/2011 Rinehart
 D662,751 S 7/2012 Morrison et al.
 D662,752 S 7/2012 Morrison et al.
 D666,448 S 9/2012 Morrison et al.
 D666,449 S 9/2012 Morrison et al.
 D670,950 S * 11/2012 Price D6/605
 D690,962 S * 10/2013 Danileson D6/605
 D696,048 S 12/2013 Morrison
 D719,763 S 12/2014 Enders
 D719,764 S 12/2014 Enders
 D720,158 S 12/2014 Harmening
 D723,839 S 3/2015 Bond et al.
 D724,353 S 3/2015 Johnson et al.
 D724,864 S 3/2015 Harmening
 D724,865 S * 3/2015 Jensen D5/56
 D724,866 S 3/2015 Johnson et al.
 D725,943 S 4/2015 Oberwelz et al.
 D726,452 S 4/2015 Jensen
 D727,663 S 4/2015 Jensen
 D728,275 S 5/2015 Jensen et al.
 D728,276 S * 5/2015 Jensen D5/56
 D728,277 S 5/2015 Jensen et al.
 D733,464 S 7/2015 Nielsen et al.
 D741,622 S 10/2015 Jensen et al.
 D742,660 S 11/2015 Oberwelz et al.
 D744,766 S 12/2015 Morrison et al.
 D744,767 S 12/2015 Morrison et al.
 D744,768 S 12/2015 Morrison et al.
 D746,082 S 12/2015 Harmening
 D746,083 S 12/2015 Jensen et al.
 D746,084 S * 12/2015 Jensen D6/606
 D746,085 S 12/2015 Jensen et al.
 D753,934 S * 4/2016 Daeseleire D6/605
 D762,079 S * 7/2016 Oberwelz D6/606
 D763,602 S 8/2016 Oberwelz et al.
 D766,017 S 9/2016 Jensen et al.
 D767,306 S 9/2016 Oberwelz et al.
 D776,960 S 1/2017 Suzuki et al.
 9,601,034 B2 3/2017 Jensen et al.
 D784,733 S * 4/2017 Bell D6/605
 D785,972 S 5/2017 Oberwelz et al.
 9,675,189 B2 6/2017 Jensen et al.
 D804,856 S 12/2017 Desodt et al.
 D804,857 S 12/2017 Desodt et al.
 D804,858 S 12/2017 Desodt et al.
 D804,859 S 12/2017 Desodt et al.

D805,327 S * 12/2017 Desodt D6/606
 D805,328 S 12/2017 Desodt et al.
 D811,127 S * 2/2018 Bell D6/605
 D811,128 S * 2/2018 Bell D6/605
 D811,776 S 3/2018 Desodt et al.
 D820,006 S 6/2018 Desodt et al.
 D820,618 S 6/2018 Desodt et al.
 9,997,089 B2 6/2018 Jensen et al.
 D823,029 S 7/2018 Jensen et al.
 D833,178 S 11/2018 Desodt et al.
 D833,179 S 11/2018 Desodt et al.
 D833,180 S 11/2018 Desodt et al.
 D833,778 S 11/2018 Desodt et al.
 D842,008 S 3/2019 Desodt et al.
 D845,677 S 4/2019 Desodt et al.
 2010/0138992 A1 6/2010 Morrison
 2014/0196647 A1 7/2014 Myers et al.
 2016/0051059 A1 2/2016 Jensen et al.
 2017/0238717 A1 8/2017 Jensen et al.
 2018/0277022 A1 9/2018 Jensen et al.

FOREIGN PATENT DOCUMENTS

AU 201711499 4/2017
 AU 201711595 4/2017
 CA 2935622 7/2015
 CA 2935633 7/2015
 CA 2956140 2/2016
 CA 2935627 7/2017
 CA 172825 11/2017
 CA 172826 11/2017
 CA 176686 11/2017
 CA 176706 11/2017
 CN 105979822 9/2016
 CN 105979823 9/2016
 CN 105979825 9/2016
 CN 4476499 1/2018
 CN ZL201730031670.4 3/2018
 EM 3729722-0001-0002 1/2017
 EM 303729714-0001 1/2017
 EM 303729714-0002 1/2017
 EP 3089621 11/2016
 EP 3089624 11/2016
 EP 3089626 10/2018
 ES 2485966 8/2014
 JP 1583849 3/2017
 JP 1589164 10/2017
 JP 1592012 11/2017
 JP 1592014 11/2017
 KR 3009310900001-02 11/2017
 TW D166222 3/2015
 WO 2015020643 2/2015
 WO 2015103171 7/2015
 WO 2015103177 7/2015
 WO 2015103186 7/2015
 WO 2016018703 2/2016

OTHER PUBLICATIONS

Stearns & Foster Estate Collection; <http://www.houstondiscountmattresses.com/steams-foster-estate-basic.html>; 1 page; accessed Jun. 1, 2018.

* cited by examiner

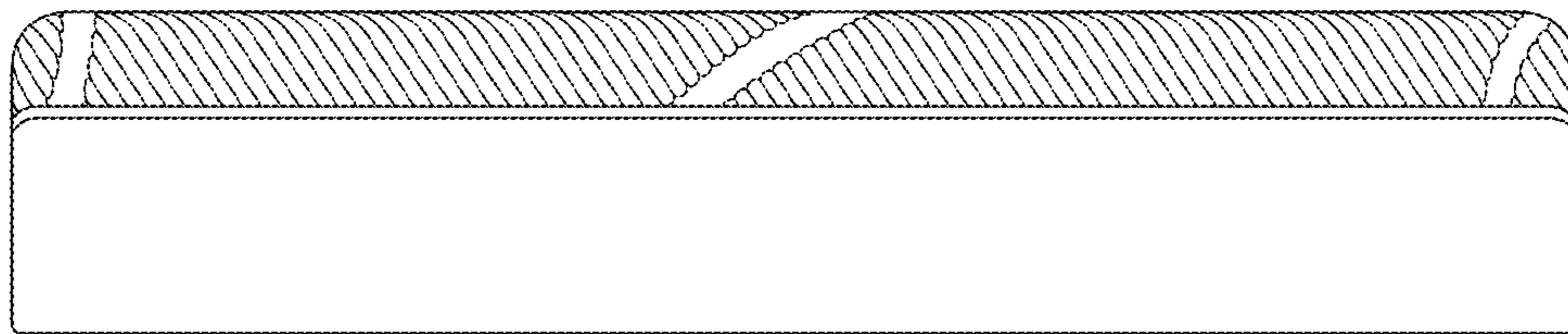

FIG. 1

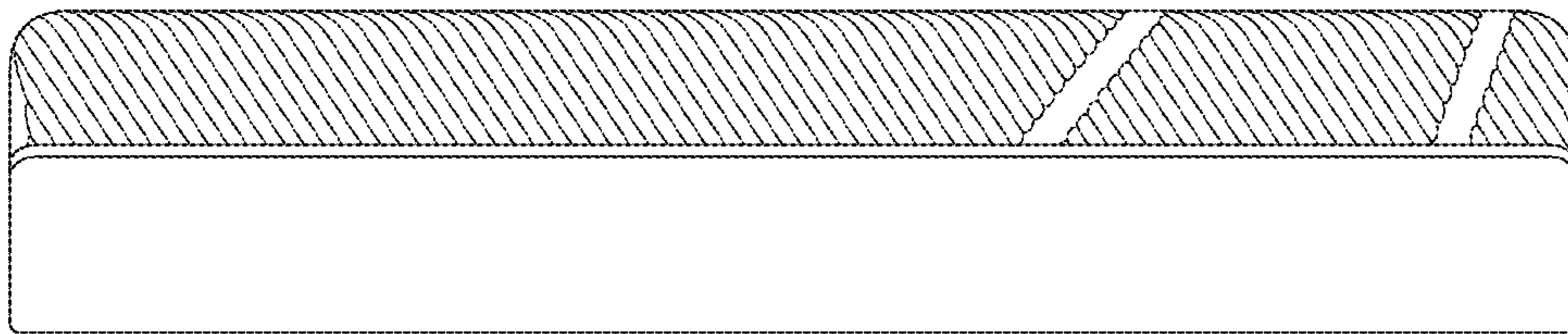

FIG. 2

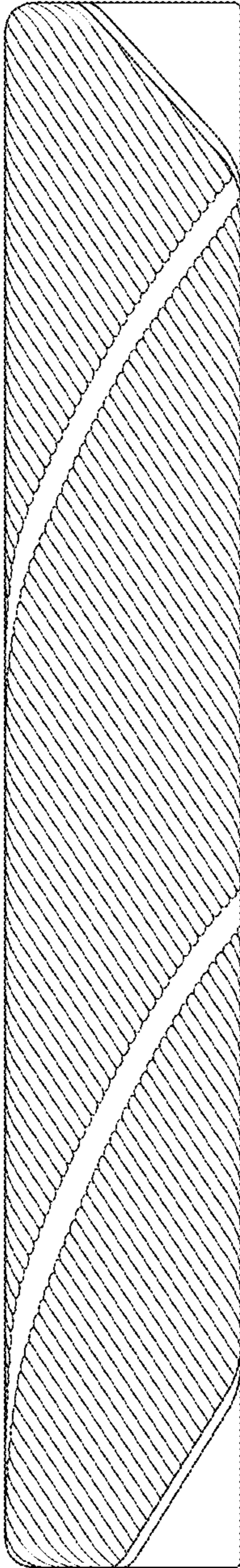

FIG. 3

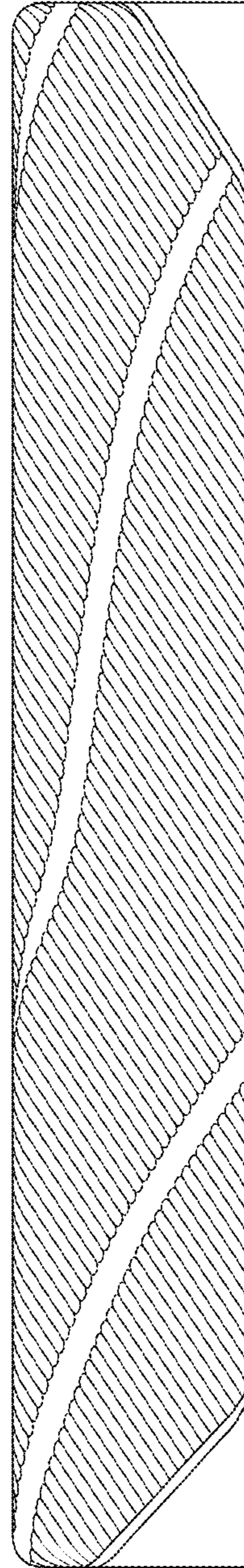

FIG. 4

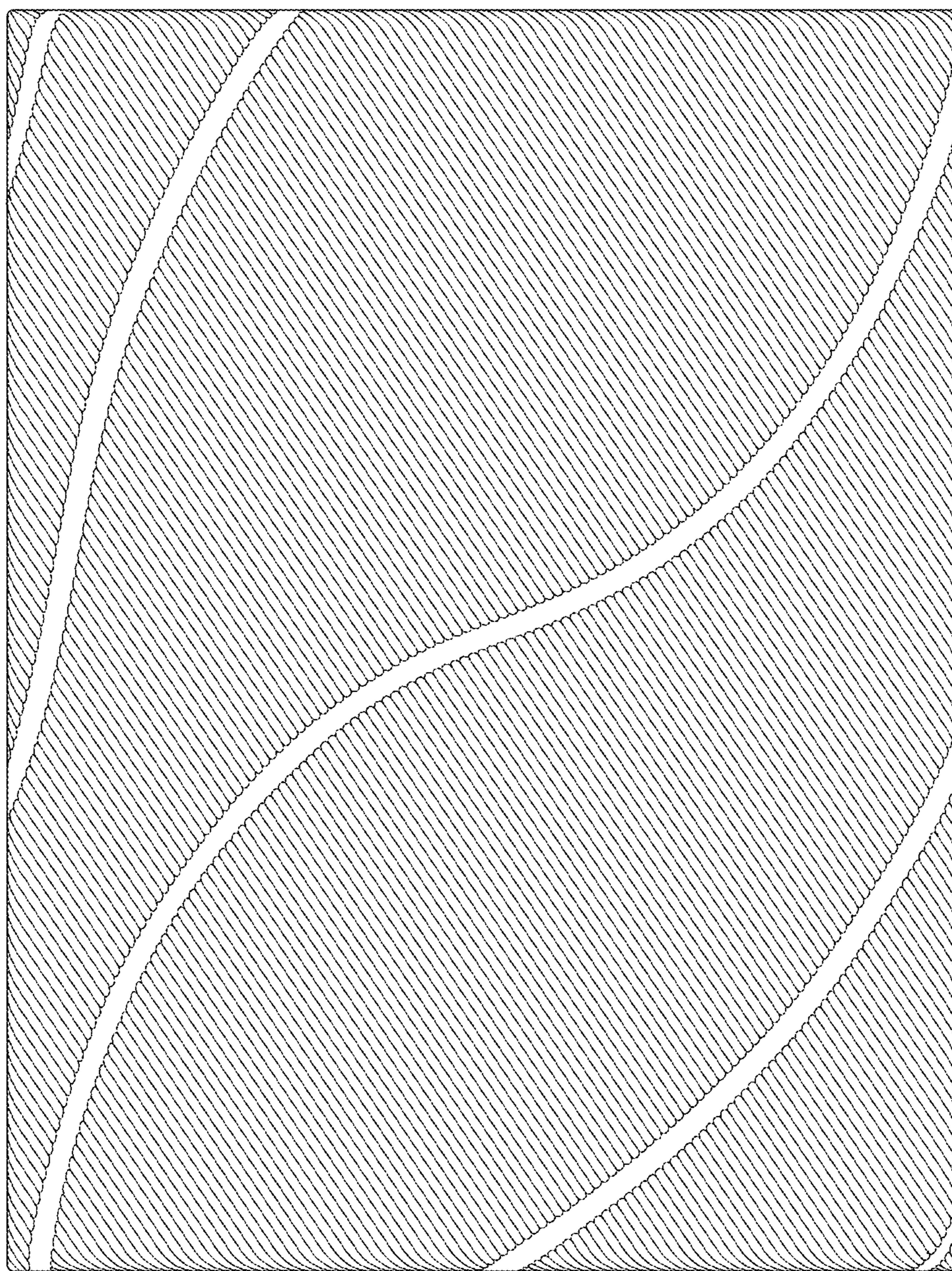

FIG. 5

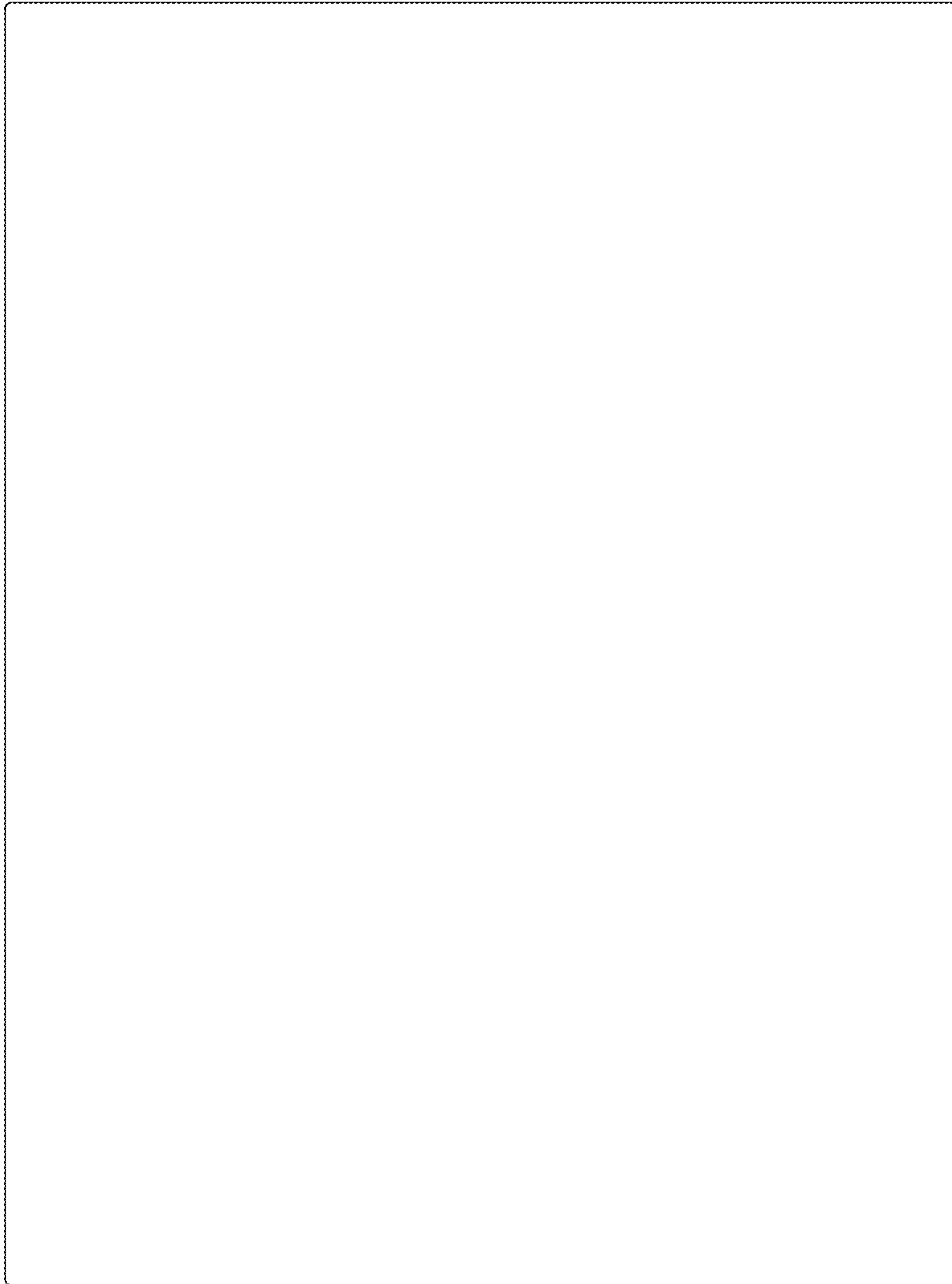

FIG. 6

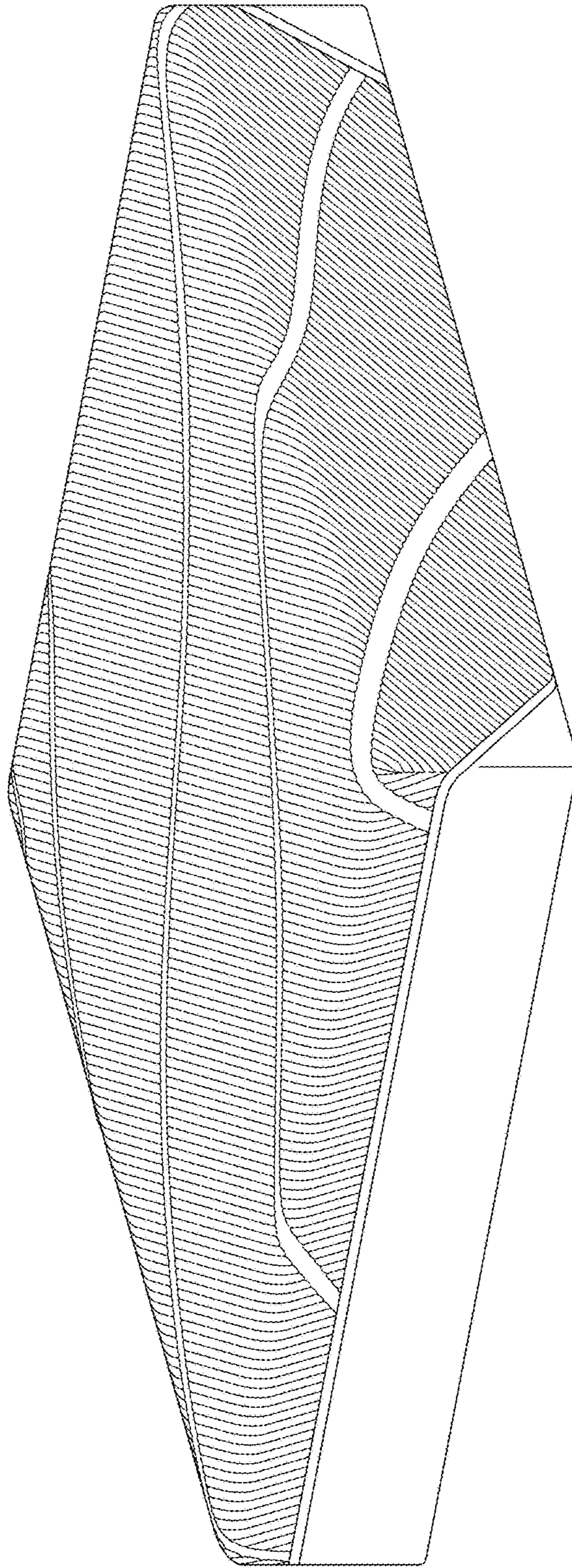

FIG. 7