



US00D862934S

(12) **United States Design Patent** (10) **Patent No.:** **US D862,934 S**  
**Pfister et al.** (45) **Date of Patent:** **\*\* Oct. 15, 2019**

(54) **MATTRESS COVER**

D353,072 S 12/1994 Cornell, Jr. et al.  
6,199,231 B1 3/2001 Zafiroglu  
6,216,292 B1 4/2001 Oakhill et al.  
(Continued)

(71) Applicant: **Tempur World, LLC**, Lexington, KY (US)

(72) Inventors: **Brent Pfister**, Lexington, KY (US); **Oleg Bobrovskyj**, Sunds (DK); **Halina Bobrovska**, Sunds (DK); **Andrij Rupa**, Sunds (DK)

FOREIGN PATENT DOCUMENTS

AU 201710516 3/2017  
AU 201710521 3/2017  
(Continued)

(73) Assignee: **TEMPUR WORLD, LLC**, Lexington, KY (US)

OTHER PUBLICATIONS

(\*\*) Term: **15 Years**

TEMPUR-Pro Adapt, earliest review Aug. 2018, [online], [site visited Mar. 1, 2019]. Available from Internet, <URL: <https://www.tempurpedic.com/shop-mattresses/tempur-proadapt/v/2577/>> (Year: 2018).\*

(21) Appl. No.: **29/634,307**

(22) Filed: **Jan. 19, 2018**

(Continued)

(51) **LOC (12) Cl.** ..... **06-09**

(52) **U.S. Cl.**  
USPC ..... **D6/605**

*Primary Examiner* — Michelle E. Wilson

*Assistant Examiner* — Sanjeev Paul

(74) *Attorney, Agent, or Firm* — Middleton Reutlinger

(58) **Field of Classification Search**

USPC ..... D6/333, 349, 355, 375, 388, 512, 563, D6/564, 595, 596, 601, 604, 605, 611, D6/707, 715, 716, 716.1; D24/183-185, D24/234; D21/803, 804, 805, 809; 5/401, 420, 600, 630, 631, 632, 633, 635, 5/636, 638, 639, 646, 652, 652.1, 655, 5/703, 730; 297/1, 2, 4, 93, 180.11, 297/195.1, 195.11, 195.13, 393, 397, 297/452.12, 452.14, 452.15, 452.21, 297/452.24, 452.26, 452.48, 452.62, 482  
CPC ..... A47G 9/10; A47G 9/1009; A47G 9/1027; A47G 9/1045; A47G 9/1063; A47G 9/1072; A47G 9/1081

See application file for complete search history.

(57) **CLAIM**

The ornamental design for a mattress cover, as shown and described.

**DESCRIPTION**

FIG. 1 is a front elevational view of the mattress cover design of the present invention;  
FIG. 2 is a rear elevational view of the mattress cover of FIG. 1;  
FIG. 3 is a left side elevational view of the mattress cover of FIG. 1;  
FIG. 4 is a right side elevational view of the mattress cover of FIG. 1;  
FIG. 5 is a top view of the mattress cover of FIG. 1;  
FIG. 6 is a bottom view of the mattress cover of FIG. 1; and,  
FIG. 7 is a perspective view of the mattress cover of FIG. 1.

(56) **References Cited**

U.S. PATENT DOCUMENTS

D38,427 S 1/1907 Pronberger  
D202,091 S 8/1965 Broderick

**1 Claim, 5 Drawing Sheets**

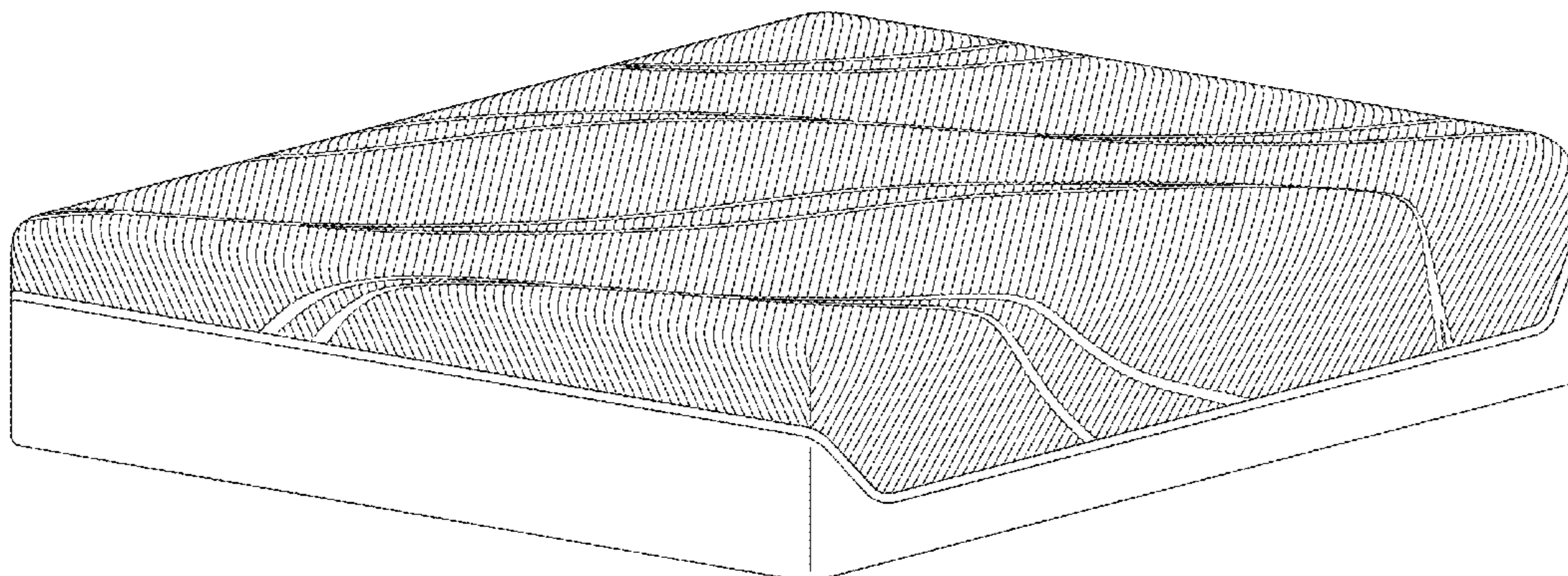

(56)

References Cited

U.S. PATENT DOCUMENTS

6,253,398 B1 7/2001 Yim  
 D488,661 S 4/2004 Barman  
 D517,848 S 3/2006 Contreras  
 D518,672 S 4/2006 Contreras  
 D519,311 S 4/2006 Contreras  
 D587,055 S 2/2009 Tucker  
 D600,485 S 9/2009 Tucker  
 D606,353 S 12/2009 Tucker  
 D616,236 S 5/2010 Morrison  
 D621,198 S 8/2010 Morrison  
 D622,088 S 8/2010 Morrison  
 D622,531 S 8/2010 Morrison et al.  
 D622,996 S 9/2010 Morrison et al.  
 D634,148 S 3/2011 Morrison  
 D640,082 S 6/2011 Morrison  
 D642,847 S 8/2011 Rinehart  
 D662,751 S 7/2012 Morrison et al.  
 D662,752 S 7/2012 Morrison et al.  
 D666,448 S 9/2012 Morrison et al.  
 D666,449 S 9/2012 Morrison et al.  
 D670,950 S \* 11/2012 Price ..... D6/605  
 D690,962 S \* 10/2013 Danileson ..... D6/605  
 D696,048 S 12/2013 Morrison  
 D719,763 S 12/2014 Enders  
 D719,764 S 12/2014 Enders  
 D720,158 S 12/2014 Harmening  
 D723,839 S 3/2015 Bond et al.  
 D724,353 S 3/2015 Johnson et al.  
 D724,864 S 3/2015 Harmening  
 D724,865 S \* 3/2015 Jensen ..... D5/56  
 D724,866 S 3/2015 Johnson et al.  
 D725,943 S 4/2015 Oberwelz et al.  
 D726,452 S 4/2015 Jensen  
 D727,663 S 4/2015 Jensen  
 D728,275 S 5/2015 Jensen et al.  
 D728,276 S \* 5/2015 Jensen ..... D5/56  
 D728,277 S 5/2015 Jensen et al.  
 D733,464 S 7/2015 Nielsen et al.  
 D741,622 S 10/2015 Jensen et al.  
 D742,660 S 11/2015 Oberwelz et al.  
 D744,766 S 12/2015 Morrison et al.  
 D744,767 S 12/2015 Morrison et al.  
 D744,768 S 12/2015 Morrison et al.  
 D746,082 S 12/2015 Morrison et al.  
 D746,083 S 12/2015 Morrison et al.  
 D746,084 S \* 12/2015 Jensen ..... D6/606  
 D746,085 S 12/2015 Jensen et al.  
 D753,934 S \* 4/2016 Daeseleire ..... D6/605  
 D762,079 S \* 7/2016 Oberwelz ..... D6/606  
 D763,602 S 8/2016 Oberwelz et al.  
 D766,017 S 9/2016 Jensen et al.  
 D767,306 S 9/2016 Oberwelz et al.  
 D776,960 S 1/2017 Suzuki et al.  
 9,601,034 B2 3/2017 Jensen et al.  
 D784,733 S \* 4/2017 Bell ..... D6/605  
 D785,972 S 5/2017 Oberwelz et al.  
 9,675,189 B2 6/2017 Jensen et al.  
 D804,856 S 12/2017 Desodt et al.  
 D804,857 S 12/2017 Desodt et al.  
 D804,858 S 12/2017 Desodt et al.  
 D804,859 S 12/2017 Desodt et al.

D805,327 S \* 12/2017 Desodt ..... D6/606  
 D805,328 S 12/2017 Desodt et al.  
 D811,127 S \* 2/2018 Bell ..... D6/605  
 D811,128 S \* 2/2018 Bell ..... D6/605  
 D811,776 S 3/2018 Desodt et al.  
 D820,006 S 6/2018 Desodt et al.  
 D820,618 S 6/2018 Desodt et al.  
 9,997,089 B2 6/2018 Jensen et al.  
 D823,029 S 7/2018 Jensen et al.  
 D833,178 S 11/2018 Desodt et al.  
 D833,179 S 11/2018 Desodt et al.  
 D833,180 S 11/2018 Desodt et al.  
 D833,778 S 11/2018 Desodt et al.  
 D842,008 S 3/2019 Desodt et al.  
 D845,677 S 4/2019 Desodt et al.  
 2010/0138992 A1 6/2010 Morrison  
 2014/0196647 A1 7/2014 Myers et al.  
 2016/0051059 A1 2/2016 Jensen et al.  
 2017/0238717 A1 8/2017 Jensen et al.  
 2018/0277022 A1 9/2018 Jensen et al.

FOREIGN PATENT DOCUMENTS

AU 201711499 4/2017  
 AU 201711595 4/2017  
 CA 2935622 7/2015  
 CA 2935633 7/2015  
 CA 2956140 2/2016  
 CA 2935627 7/2017  
 CA 172825 11/2017  
 CA 172826 11/2017  
 CA 176686 11/2017  
 CA 176706 11/2017  
 CN 105979822 9/2016  
 CN 105979823 9/2016  
 CN 105979825 9/2016  
 CN 1476499 1/2018  
 CN ZL201730031670.4 3/2018  
 EM 003729714-0001 1/2017  
 EM 003729714-0002 1/2017  
 EM 3729722-0001-0002 1/2017  
 EP 3089621 11/2016  
 EP 3089624 11/2016  
 EP 3089626 10/2018  
 ES 2485966 8/2014  
 JP 1583849 3/2017  
 JP 1589164 10/2017  
 JP 1592012 11/2017  
 JP 1592014 11/2017  
 KR 3009310900001-02 11/2017  
 TW D166222 3/2015  
 WO 2015020643 2/2015  
 WO 2015103171 7/2015  
 WO 2015103177 7/2015  
 WO 2015103186 7/2015  
 WO 2016018703 2/2016

OTHER PUBLICATIONS

Stearns & Foster Estate Collection; <http://www.houstondiscountmattresses.com/steams-foster-estate-basic.html>; 1 page; accessed Jun. 1, 2018.

\* cited by examiner

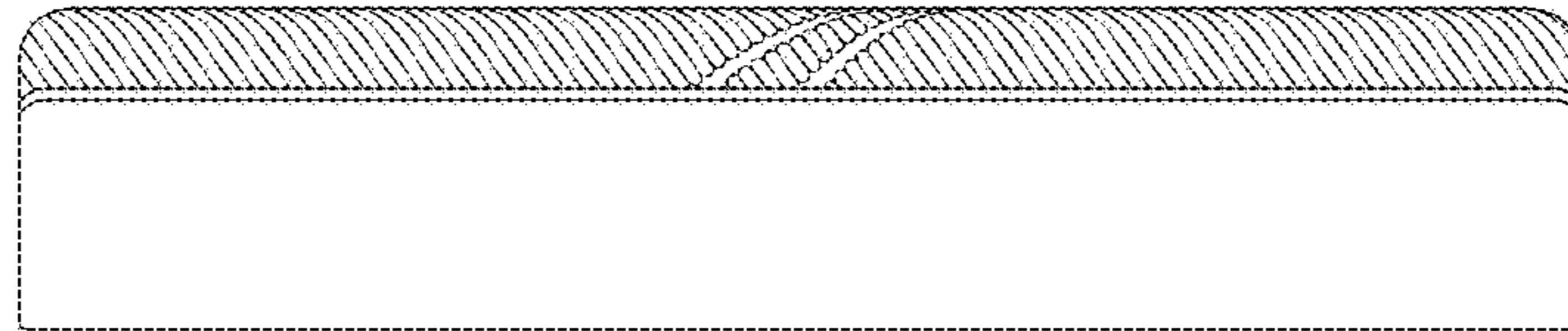

FIG. 1

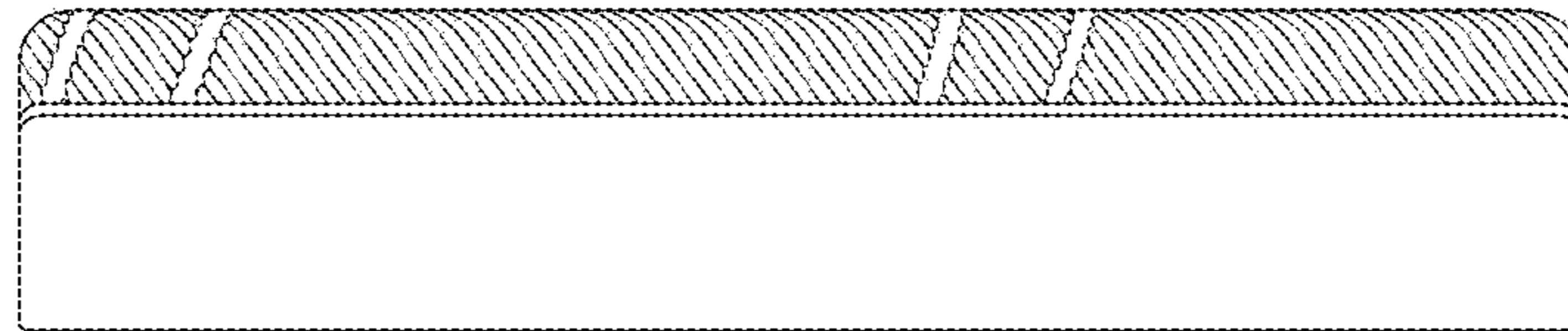

FIG. 2

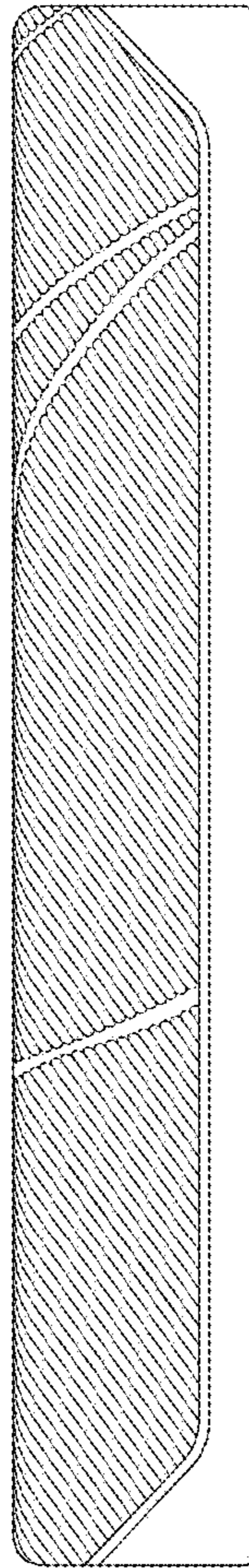

FIG. 3

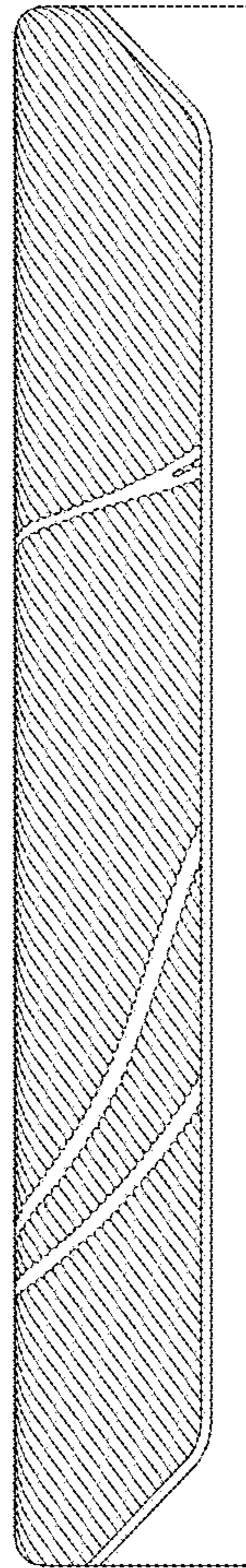

FIG. 4

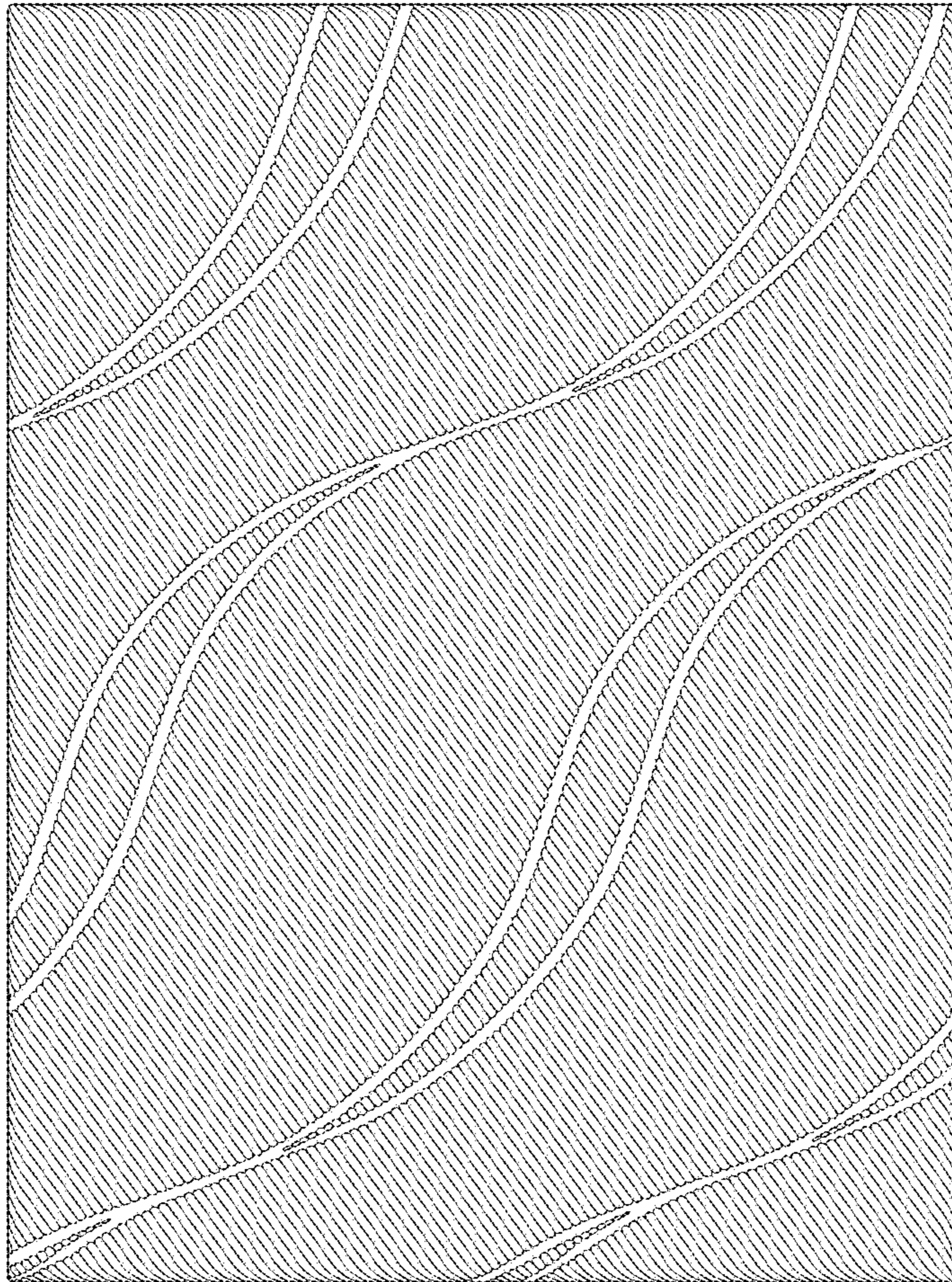

FIG. 5



FIG. 6

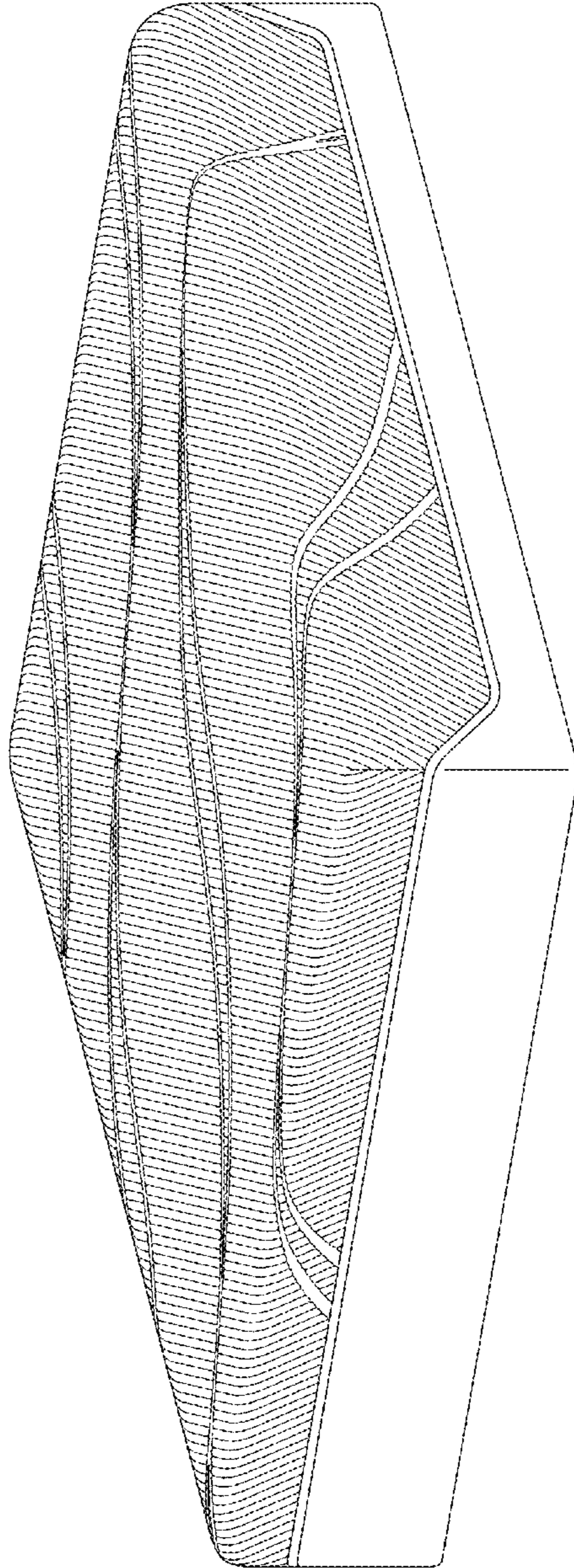

FIG. 7