



US00D862911S

(12) **United States Design Patent**  
**Challender**

(10) **Patent No.:** **US D862,911 S**

(45) **Date of Patent:** **\*\* Oct. 15, 2019**

(54) **CLOTHES RACK**

(71) Applicant: **Diane Challender**, Laceby (GB)

(72) Inventor: **Diane Challender**, Laceby (GB)

(\*\*) Term: **15 Years**

(21) Appl. No.: **35/505,593**

(22) Filed: **Jul. 3, 2018**

(80) **Hague Agreement Data**

Int. Filing Date: **Jul. 3, 2018**

Int. Reg. No.: **DM/102509**

Int. Reg. Date: **Jul. 3, 2018**

Int. Reg. Pub. Date: **Sep. 7, 2018**

(51) **LOC (12) Cl.** ..... **06-08**

(52) **U.S. Cl.**  
USPC ..... **D6/320**

(58) **Field of Classification Search**  
USPC ..... D6/315, 317, 320, 322, 325, 512, 553  
CPC ..... A47B 61/00; A47B 61/003; A47G 25/02;  
A47G 25/14; A47G 25/28; A47G 25/74;  
A47G 25/746  
See application file for complete search history.

(56) **References Cited**

**U.S. PATENT DOCUMENTS**

- 942,564 A \* 12/1909 Ireland ..... E06B 9/323  
248/251
- 2,428,454 A \* 10/1947 Fowler ..... A47G 25/746  
211/104
- D164,396 S \* 8/1951 Zimmer ..... 211/105

- D184,142 S \* 12/1958 Johnston ..... D6/320  
2,927,719 A \* 3/1960 Wareham ..... A47G 25/02  
211/207
- D201,186 S \* 5/1965 Davis ..... A47G 25/02  
D19/90
- D243,978 S \* 4/1977 Lallement ..... A47B 61/003  
D6/325
- 4,760,929 A \* 8/1988 Fedorchak ..... A47B 61/003  
211/105.1
- D366,905 S \* 2/1996 Heller ..... A47B 61/003  
D19/81
- 2006/0278594 A1 \* 12/2006 Macon ..... A47B 61/003  
211/123
- 2018/0177292 A1 \* 6/2018 Rindler ..... A47B 61/003

\* cited by examiner

*Primary Examiner* — Mary Ann Calabrese

(57) **CLAIM**

The ornamental design for a clothes rack, as shown and described.

**DESCRIPTION**

- 1. Clothes rack
- 1.1 : Perspective
- 1.2 : Front
- 1.3 : Back
- 1.4 : Top
- 1.5 : Bottom
- 1.6 : Right
- 1.7 : Left

No protection is sought for the features shown in broken lines. The clothes rack is shown with a symbolic break in its length. The appearance of any portion of the article between the break lines forms no part of the claimed design.

**1 Claim, 7 Drawing Sheets**

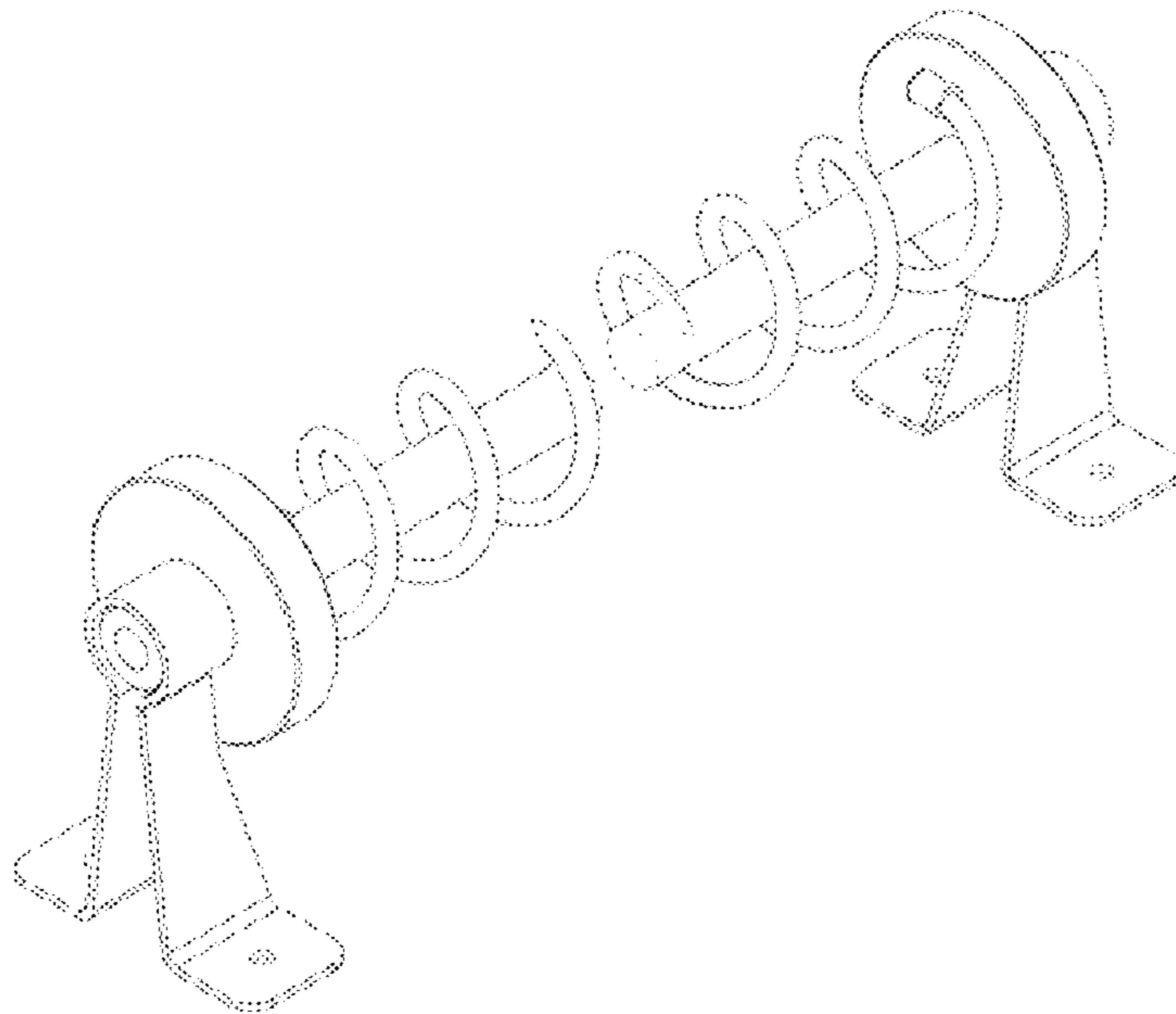

**1.1**

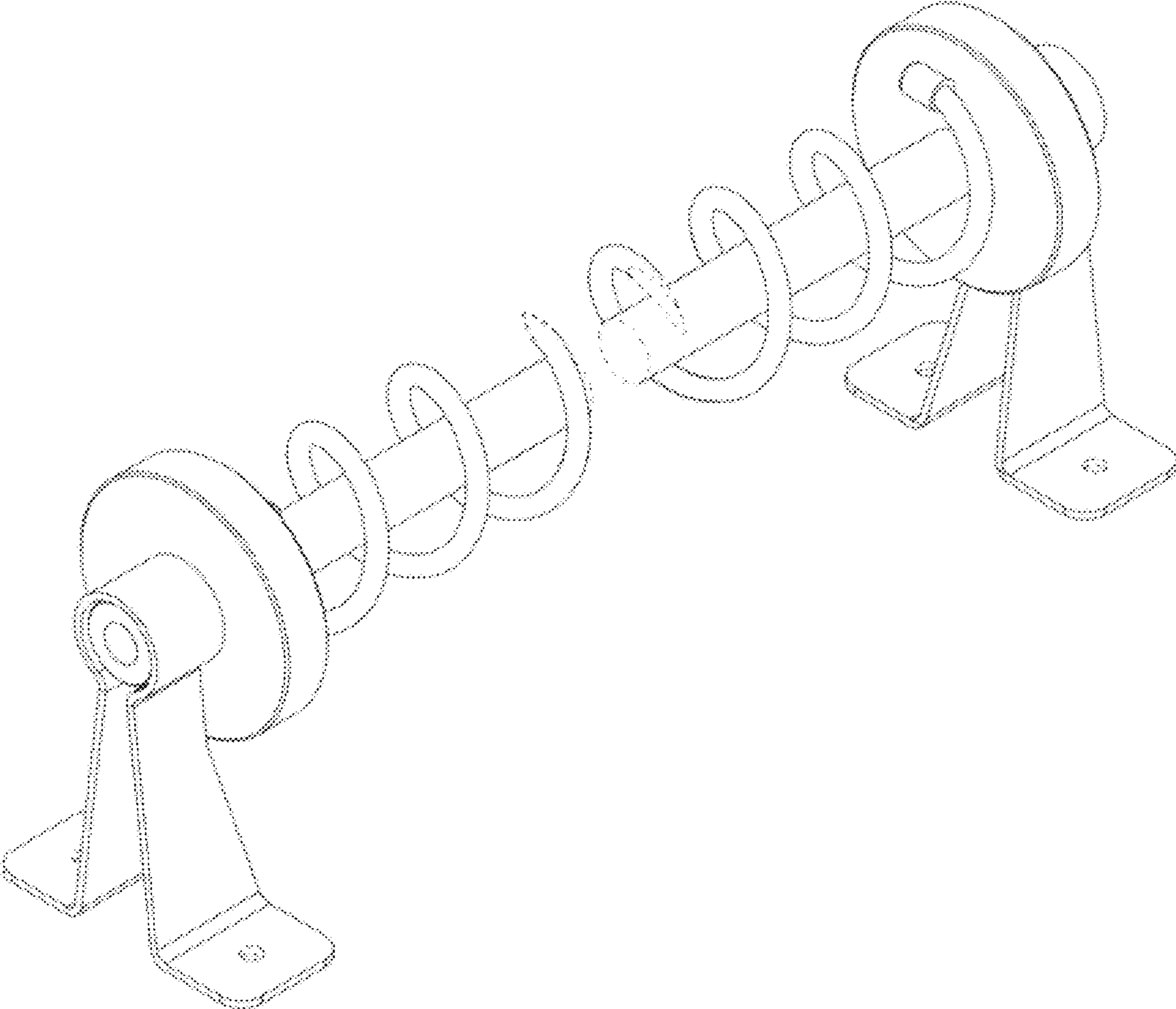

**1.2**

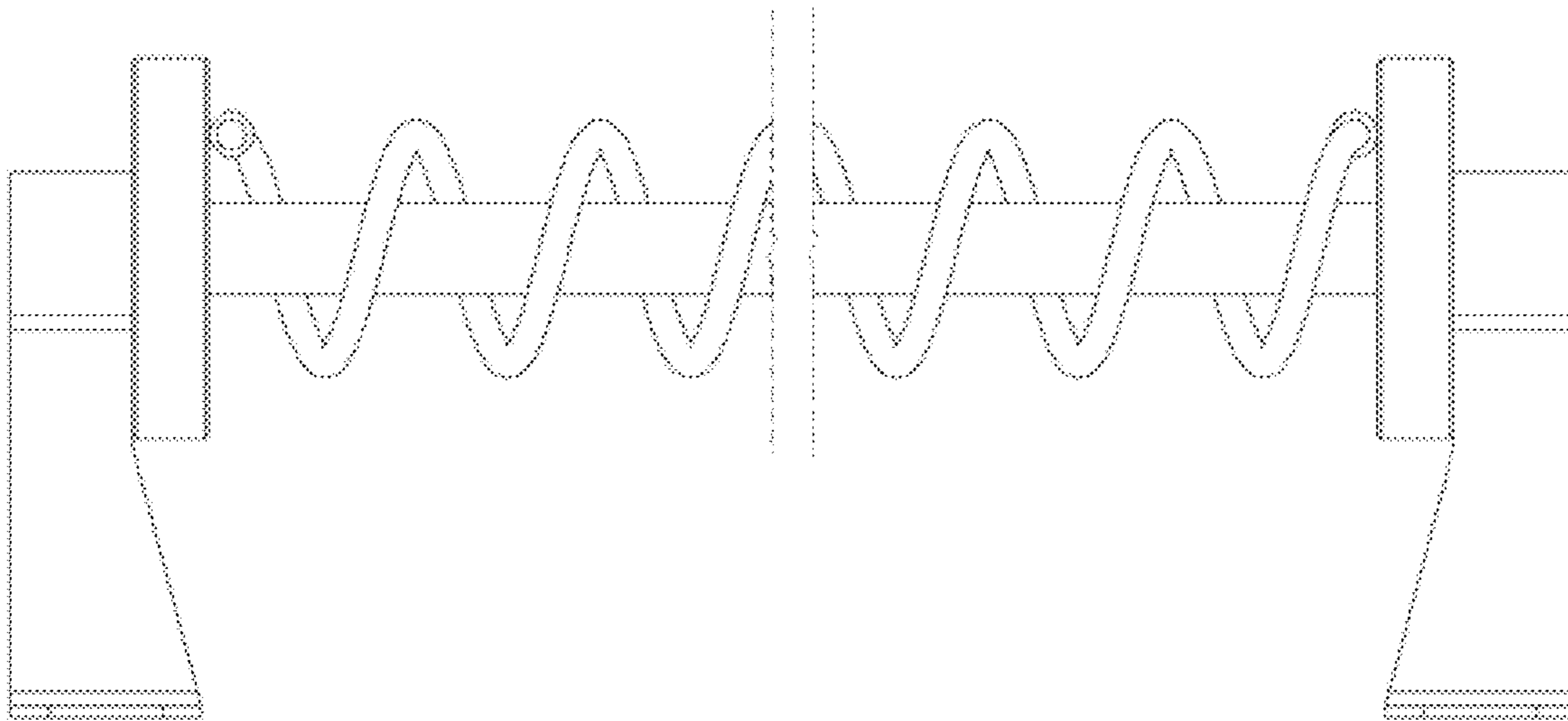

**1.3**

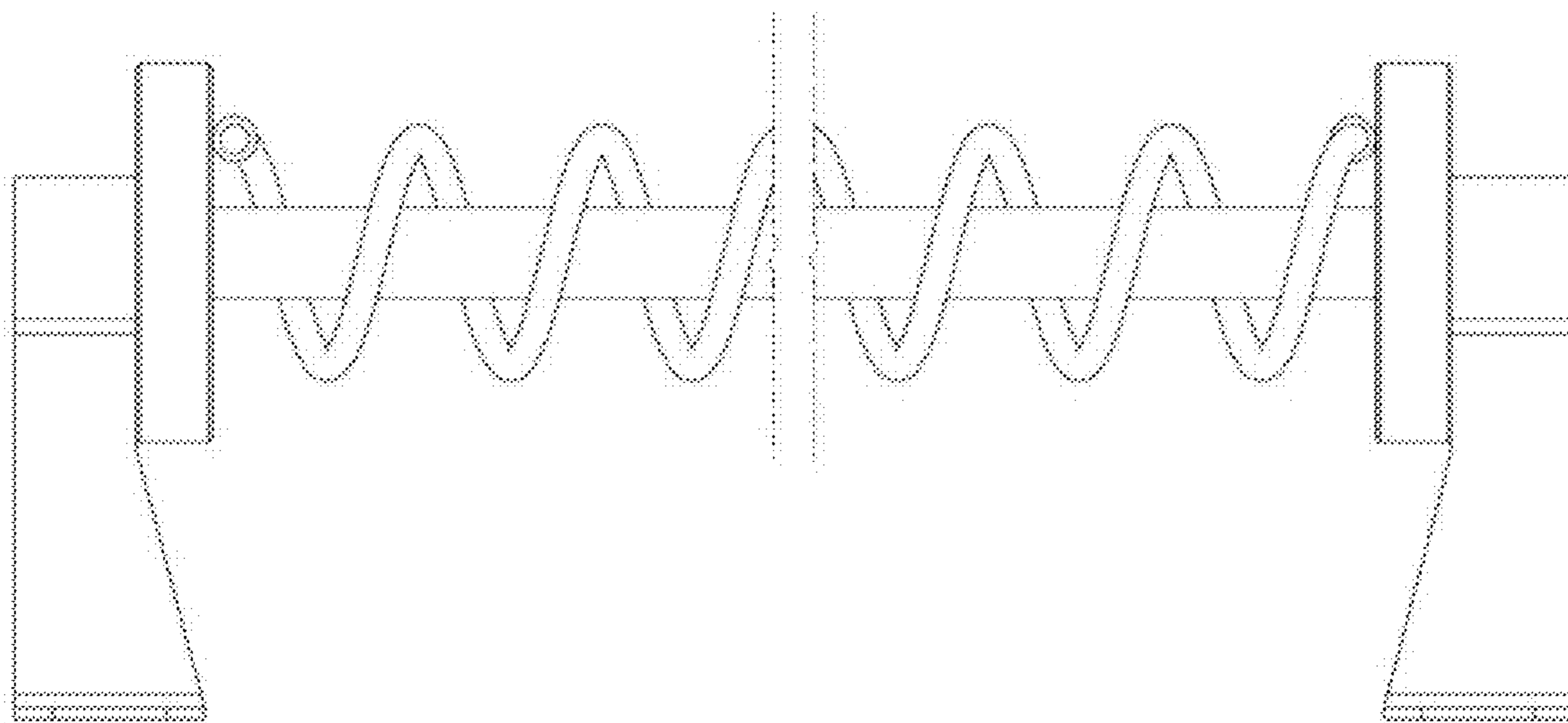

**1.4**

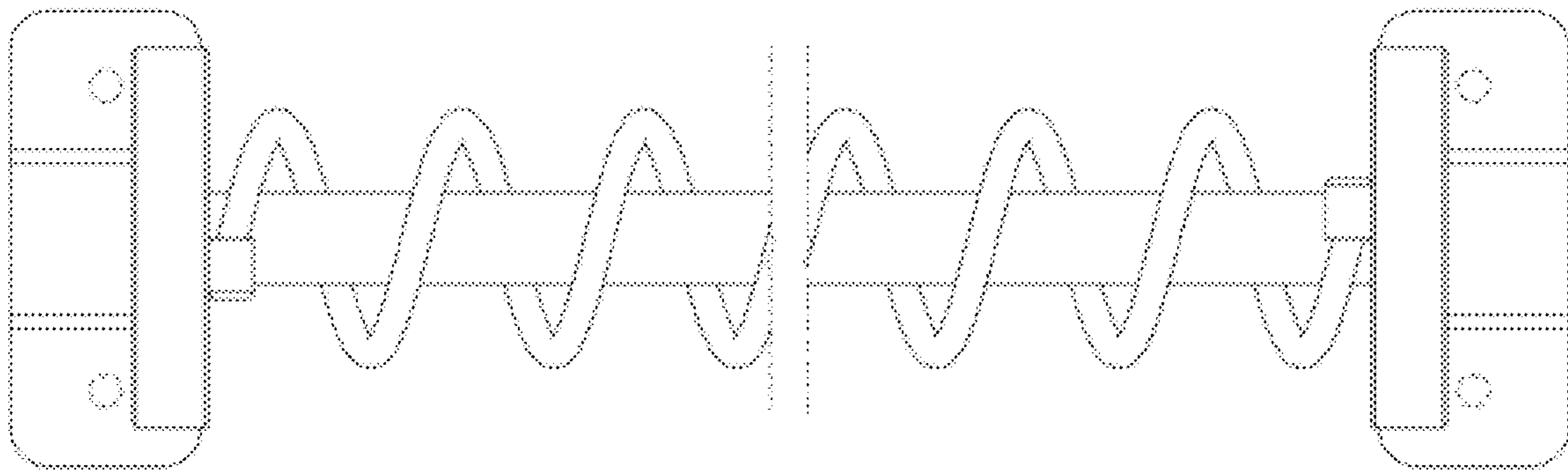

1.5

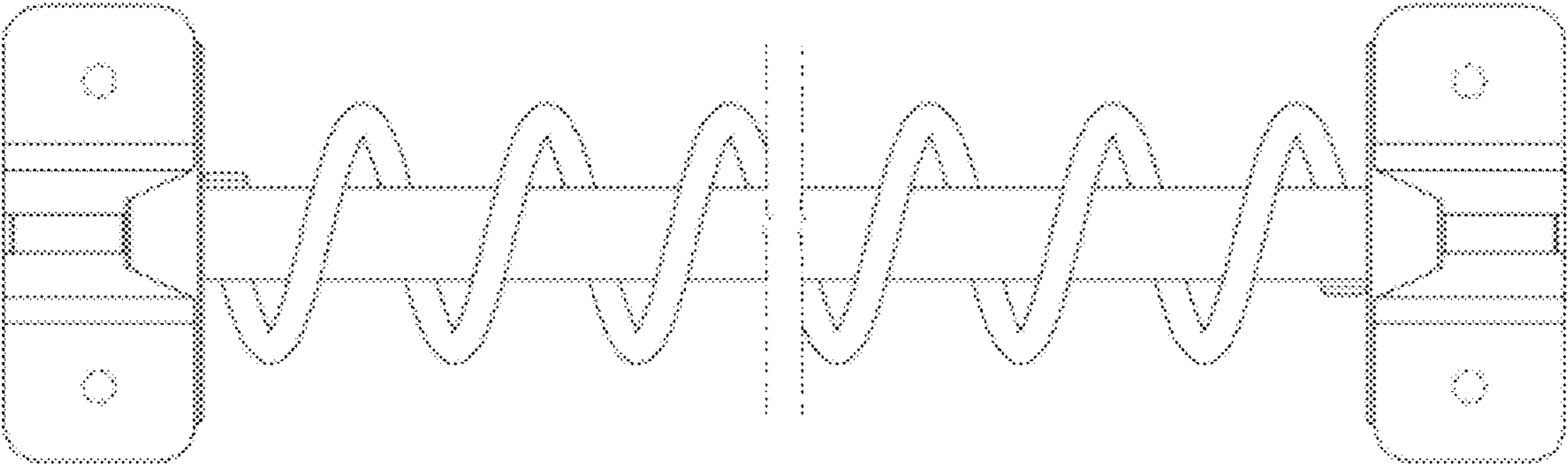

**1.6**

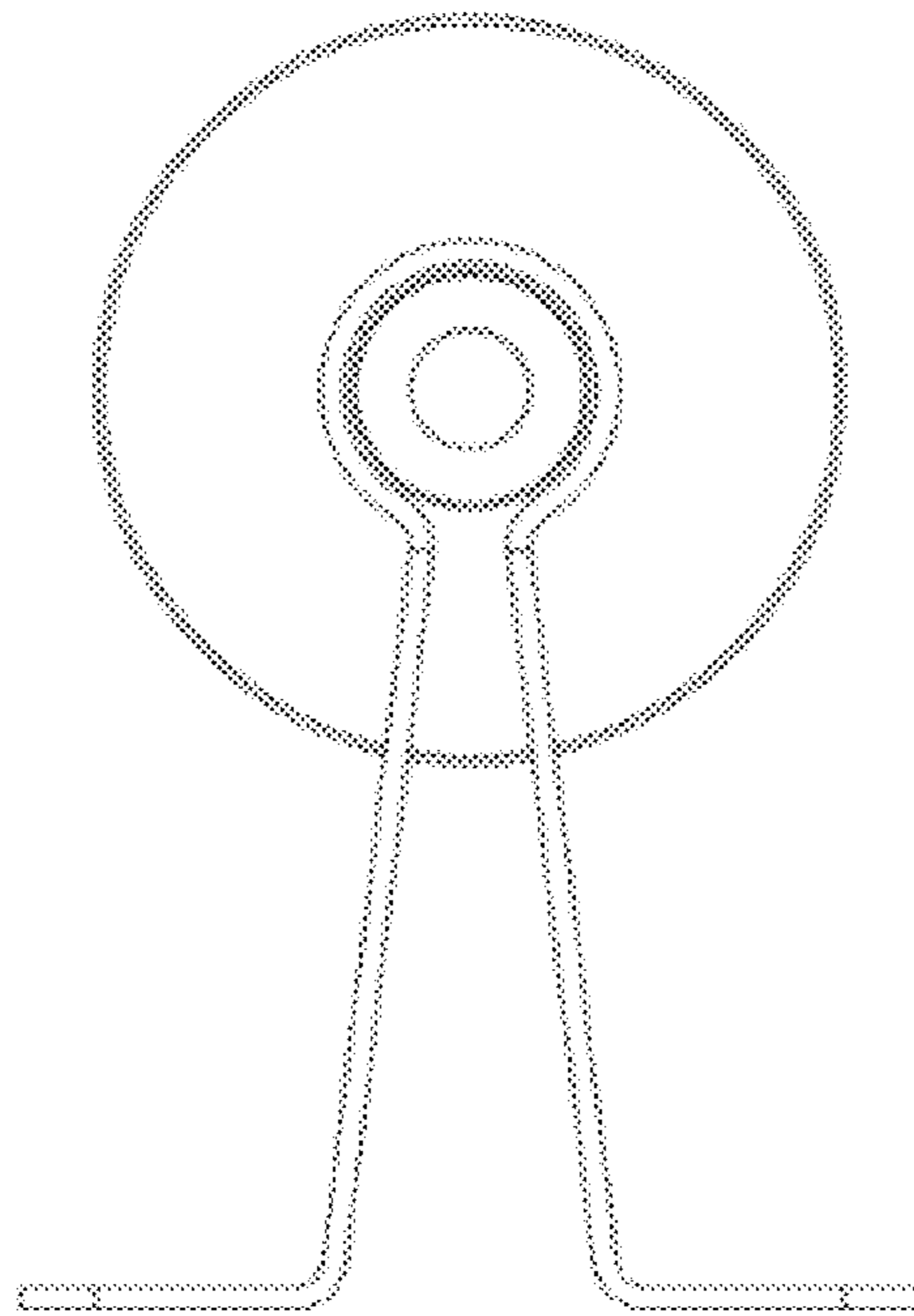



**1.7**

